



SEMI-FLUSH MOUNT

ISF511A03
ISF578A03
10/14

QUESTIONS OR CONCERNS CONTACT CANARM AT:
1-800-265-1833 (English) / 1-800-567-2513 (French)
Monday through Friday 8:00 AM to 5:00 PM E.S.T.

TOOLS AND MATERIALS REQUIRED:



Phillips
Screwdriver

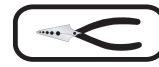

Wire Cutters

Wiring supplies
as required by
electrical code



Pliers



Wrench



INSTRUCTIONS PERTAINING TO RISK OF FIRE OR INJURY TO PERSONS
READ ALL INSTRUCTIONS

IMPORTANT SAFETY INSTRUCTIONS

SAVE THESE INSTRUCTIONS

SAFETY PRECAUTIONS:

1. **TURN OFF ELECTRICAL POWER BEFORE STARTING INSTALLATION OF LIGHT FIXTURE.**
 2. **THIS PRODUCT MUST BE INSTALLED IN ACCORDANCE WITH THE APPLICABLE INSTALLATION CODE BY A PERSON FAMILIAR WITH THE CONSTRUCTION AND OPERATION OF THE PRODUCT AND THE HAZARDS INVOLVED.**
 3. **CAUTION – RISK OF FIRE. CONSULT A QUALIFIED ELECTRICIAN TO ENSURE CORRECT BRANCH CIRCUIT CONDUCTOR.**
 4. **CONNECT THE GROUND WIRES (BARE COPPER OR GREEN) FROM YOUR FIXTURE TO THE GROUND WIRE (BARE COPPER OR GREEN) OR GROUND SCREW IN THE ELECTRICAL OUTLET BOX.**
- NOTE: Product May Not Look Exactly As Shown In Figures.**

INSTALLATION:

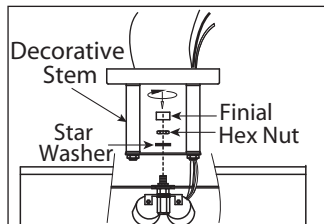

1. Carefully insert the decorative stem into the screw stud and tighten by a star washer, hex nut and the finial.

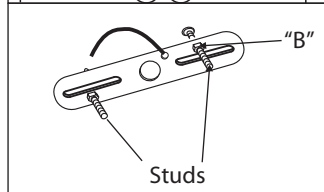

2. Loosen "B". Adjust stud to desired length and lock in place with "B".

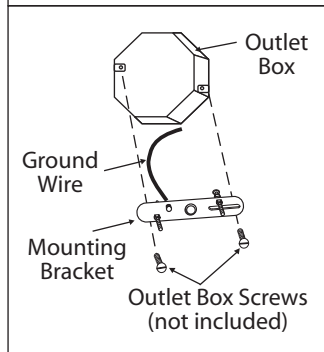

3. Mount the mounting bracket to outlet box using outlet box screws (not included). Make sure the studs or nipple on the mounting bracket are facing out from the outlet box.

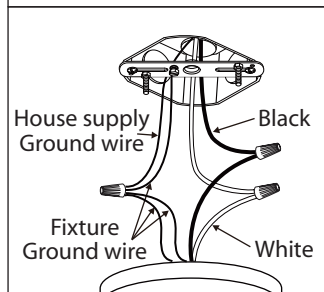

4. Connect the ground wires (bare copper or green) from your fixture to the ground wires (bare copper or green) or ground screw in the electrical outlet box. Connect black wire from fixture to black wire in outlet box and connect the white wire from fixture to white wire in outlet box.

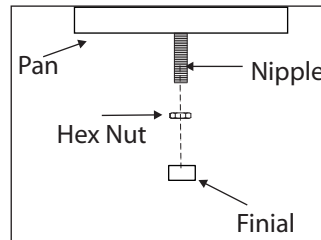

5. Secure the pan to the nipple by tightening the hex nut. Screw the finial to the nipple.

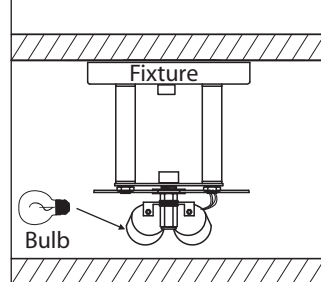

6. Install proper bulb type and wattage (not included).

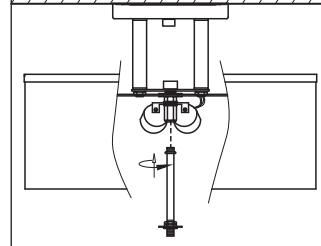

7. Warning: Risk of Shock
Start threading stem into "open coupling" till stem just appears on the inside of open coupling. **Be careful not to damage the wires while installing.**

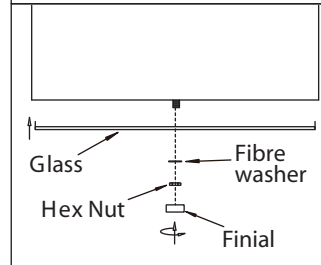

8. Attach the stem to the fixture. Secure the glass in place using the fibre washer, hex nut, and finial.