

PRUVEEO

ACTIVATE AND GET TWO YEARS WARRANTY

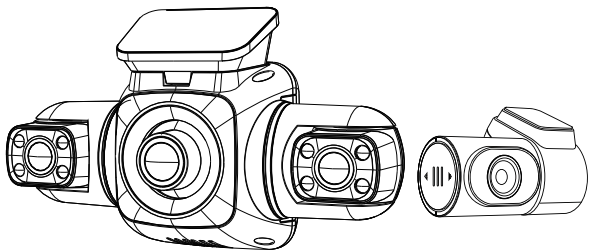

User Manual



Scan the QR code or visit pruveeo.com/pages/wty to learn more
If you have any questions, please contact us with no hesitation at
support@pruveeo.us for quick solutions.

Safety information

To prevent injury to yourself or others, or damage to your device, read all safety information before using.



Warning

Failure to comply with safety warnings and regulations can result in serious injury or death.

PRUVEEO Dash Cam is not intended to be touched, modified, or calibrated while operating a vehicle. PRUVEEO is not responsible for any damages resulting from the user's misuse of the camera.

Do not use damaged power cords or plugs, or loose electrical sockets. Faulty connections can cause electric shock or fire.

Do not touch the car charger with wet hands or disconnect the charger by pulling the cord. Doing so may result in electrocution.

Do not use a bent or damaged car charger. Doing so may cause electric shock or fire.

Do not use your device while it is charging or touch your device with wet hands. Doing so may cause electric shock.

- **Use only manufacturer-approved chargers, accessories, and supplies.**
 - Use only the manufacturer-approved charger specifically designed for your device. Using an incompatible charger can cause serious personal injury or damage to your device.
 - PRUVEEO cannot be responsible for the user's safety when using accessories or supplies that are not approved by PRUVEEO.

- **Do not drop the charger or device, or subject them to impact. Handle and dispose of the charger and device with care.**
 - Never crush or puncture the device.
 - Never dispose of the device in a fire.
 - Never place the device in or on heating devices, such as microwave ovens, stoves, or radiators. The device may explode if overheated. Follow all local regulations when disposing of a used device.
 - Avoid exposing the device to high external pressure, which can lead to an internal short circuit and overheating.

- **Protect the device and charger from damage.**
 - Avoid exposing your device to excessive cold or heat. Extreme temperatures can damage the device and reduce the charging capacity and life of your device.
 - Do not allow children or animals to bite or chew the device. Doing so can result in fire or explosion, and small parts can be a choking hazard. If children use the device, make sure they use the device properly.
 - Never use a damaged charger.

Caution

Failure to comply with safety precautions and regulations can result in property damage, serious injury, or death.

Do not use your device near other electronic devices. Most electronic devices use radio frequency signals. Your device may interfere with other nearby electronic devices.

Do not use your device near other devices that emit radio signals, such as sound systems or radio towers. Radio signals from these may cause your device to malfunction.

Do not expose the device to heavy smoke or fumes. Doing so may damage the outside of the device or cause it to malfunction.

If you notice strange smells or sounds coming from your device, or if you see smoke or liquid leaking from the device, stop using the device immediately and take it to a PRUVEEO Service Center. Failure to do so may result in fire or explosion.

For your safety, do not operate the controls of this product while driving. The window mount is needed when using the dash cam in a car. Make sure that you place the dash cam in a location where it will not obstruct the driver's view.

Always keep the camera lens clean, and ensure that the lens is not blocked by any object or placed near any reflective material. If the car's windshield is tinted with a dark coating, recording quality may be affected.

Your device is recommended for use and storage within a temperature range of 15 degrees Fahrenheit to 150 degrees Fahrenheit, and a humidity range of 10% to 80%.

If your device becomes overheated, allow it to cool down before use. Prolonged exposure of skin to an overheated device may cause low-temperature burn symptoms, such as red spots or areas of darker pigmentation.

Install mobile devices and equipment with caution.

- Ensure that any mobile devices or related equipment installed in your vehicle are securely mounted.

- Avoid placing your device and accessories in or near an airbag deployment area. Improperly installed wired equipment can cause serious injury in a situation where airbags inflate rapidly.

Do not drop your device or subject your device to impact. If the device is bent, deformed, or damaged, malfunction may occur.

Do not attempt to disassemble, repair, or modify your device.

- Any changes or modifications to your device can void your manufacturer's warranty. If your device needs servicing, take it to an authorized PRUVEEO Service Center.

Clean your device and charger by wiping it with a towel or eraser. Do not use chemicals or detergents. Doing so can discolor or corrode the outside of the device, and may result in electric shock or fire.

Do not distribute copyright-protected material. Doing so without the permission of the content owners may violate copyright laws. The manufacturer is not responsible or liable for any legal issues that result from the user's illegal use of copyrighted material.

(applicable in countries with separate waste collection systems)



Waste Electrical & Electronic Equipment

This symbol, found on the device, accessories, or accompanying literature, indicates that the product and its electronic accessories (e.g. charger, headset, USB cable) should not be disposed of with other household waste.

To prevent possible harm to the environment or human health from uncontrolled waste disposal, please separate these items from other types of waste and recycle them responsibly to promote the sustainable reuse of material resources.

Household users should contact either the retailer where they purchased this product, or their local government office, for information on where and how they can take these items for environmentally safe recycling.

Business users should contact their supplier and check the terms and conditions of the purchase contract. This product and its electronic accessories should not be mixed with other commercial wastes for disposal.

Some content and services accessible through this device belong to third parties and are protected by copyright, patent, trademark, and/or other intellectual property laws. Such content and services are provided solely for your personal non-commercial use.

You may not use any content or services in a manner that has not been authorized by the content owner or service provider. Without limiting the foregoing, unless expressly authorized by the applicable content owner or service provider, you may not modify, copy, republish, upload, post, transmit, translate, sell, create derivative works, exploit, or distribute in any manner or medium any content or services displayed through this device.

"THIRD PARTY CONTENT AND SERVICES ARE PROVIDED "AS IS." PRUVEEO DOES NOT WARRANT CONTENT OR SERVICES SO PROVIDED, EITHER EXPRESSLY OR IMPLIEDLY, FOR ANY PURPOSE. PRUVEEO EXPRESSLY DISCLAIMS ANY IMPLIED WARRANTIES, INCLUDING BUT NOT LIMITED TO, WARRANTIES OF MERCHANTABILITY OR FITNESS FOR A PARTICULAR PURPOSE. PRUVEEO DOES NOT GUARANTEE THE ACCURACY, VALIDITY, TIMELINESS, LEGALITY, OR COMPLETENESS OF ANY CONTENT OR SERVICE MADE AVAILABLE THROUGH THIS DEVICE AND UNDER NO CIRCUMSTANCES, INCLUDING NEGLIGENCE, SHALL PRUVEEO BE LIABLE, WHETHER IN CONTRACT OR TORT, FOR ANY DIRECT, INDIRECT, INCIDENTAL, SPECIAL OR CONSEQUENTIAL DAMAGES, ATTORNEY FEES, EXPENSES, OR ANY OTHER DAMAGES ARISING OUT OF, OR IN CONNECTION WITH, ANY INFORMATION CONTAINED IN, OR AS A RESULT OF THE USE OF ANY CONTENT OR SERVICE BY YOU OR ANY THIRD PARTY, EVEN IF ADVISED OF THE POSSIBILITY OF SUCH DAMAGES."

Third-party services may be terminated or interrupted at any time, and PRUVEEO makes no representation or warranty that any content or service will remain available for any period. Content and services are transmitted by third parties using networks and transmission facilities over which PRUVEEO has no control. Without limiting the generality of this disclaimer, PRUVEEO expressly disclaims any responsibility or liability for any interruption or suspension of any content or service made available through this device.

PRUVEEO is neither responsible nor liable for customer service related to the content and services. Any question or request for service relating to the content or services should be made directly to the respective content and service providers.

This device complies with part 15 of the FCC Rules. Operation is subject to the following two conditions:

This device may not cause harmful interference, and this The device must accept any interference received, including interference that may cause undesired operation.

This equipment has been tested and found to comply with the limits for a Class B digital device, pursuant to part 15 of the FCC Rules. These limits are designed to provide reasonable protection against harmful interference in a residential installation. This equipment generates, uses and can radiate radio frequency energy and, if not installed and used in accordance with the instructions, may cause harmful interference to radio communications. However, there is no guarantee that interference will not occur in a particular installation. If this equipment does cause harmful interference to radio or television reception, which can be determined by turning the equipment off and on, the user is encouraged to try to correct the interference by one or more of the following measures:

- Reorient or relocate the receiving antenna.
- Increase the separation between the equipment and receiver.
- Connect the equipment into an outlet on a circuit different from that to which the receiver is connected.
- Consult the dealer or an experienced radio/TV technician for help.

Caution: Any changes or modifications not expressly approved by the party Responsible for compliance could void the user's authority to operate the equipment.

This equipment complies with FCC radiation exposure limits set forth for an uncontrolled environment. This transmitter must not be co-located or operating in conjunction with any other antenna or transmitter.

This equipment should be installed and operated with minimum distance 20cm between the radiator&your body.

We recommend that you read this manual carefully before using the dash cam, and then read it again with the dash cam in your hands to familiarize yourself with its many features. The dash cam is constantly being improved over time, so the specifications of the dash cam may change.



Please note that each button has multiple functions, so please be careful which buttons you press for each mode/function. There is no need to get frustrated as you should only have to do this once to set it up the way you want.

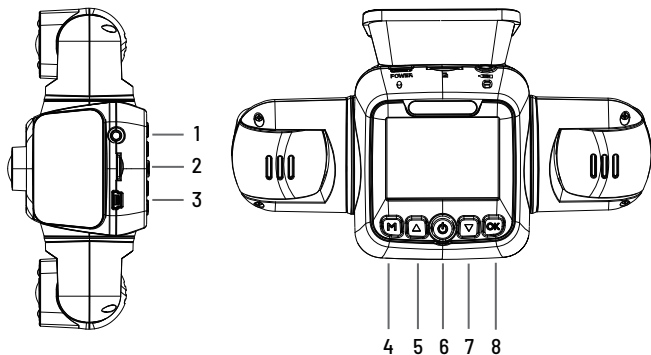

1. Please make sure that the dash cam is switched off when inserting or removing a Micro SD card to avoid damage.
2. Please make sure that the Micro SD card is inserted correctly. If it is backward, it may damage the dash cam and the card.
3. If the Micro SD Card is not compatible with the dash cam, please DO NOT insert it again, as you will damage the card and the dash cam. Please buy the correct card and then try again.
4. The dash cam supports the micro SD card from 32GB to the max capacity of 256GB.
5. Adjust the position of the lens to make sure you can properly record what you want.
6. We recommend our high endurance 128GB or 256G MicroSDXC memory card for this dash cam (www.amazon.com/dp/B0C1NL4BS8). Please DO NOT use "Generic Class 10" cards from third parties. They are NOT designed for 4-channel recording dash cam.
7. In the video recording mode, if you want to press the Menu / Mode button, please stop video recording first.
8. We recommend to use the factory default settings, once the MENU is set, connect the car charger to the unit and insert the card. When the car starts, the unit will automatically start recording. When the car is turned off, the unit will automatically stop recording. Please note that the car's cigarette lighter socket has no power when the ignition is turned off.

9. This dash cam must be always connected to a power source via a 5V charger as there is no built-in battery.
10. If you set the SCREEN SAVER option to ON, the dash cam will continue to record in video recording mode when the screen is turned off. You can turn on the screen by pressing the power button once.
11. If you want to play the videos, we recommend that you remove the micro SD card and insert it into your PC with a card reader. We recommend using the VLC video player on Windows OS and Movist + VLC on MAC OS.
12. After several weeks of daily recording, you may need to format your Micro SD card - if this happens, please note that you will lose all your files, so please make a backup copy on your computer in a unique dash cam folder that you have created.
13. If your dash cam crashes / screen goes black, the phenomenon may be caused by improper operation or crash, please press the R = Reset button, the hole at the top corner, gently with a cocktail stick. Just like you would do for a computer, printer, phone, etc.
14. The dash cam only supports micro SD cards with FAT32 file format. Please format your micro SD card on the dash cam before using it.
15. Currently, GPS technology struggles to get signals and accuracy indoors. There are two main reasons why GPS can't be used indoors: low signal strength and low accuracy.



1. Rear Camera Slot
2. Micro SD Card Slot
3. Power Slot
4. Menu Button / Mode Switch Button
5. Video On/Off / Take Photo Button
6. Power Button / Screen On/Off Button
7. Screen Switching / Audio On/Off Button
8. Confirm Button / Emergency Lock Button

Button	Functions
	Press to turn on or off the screen Press and hold for 3 seconds to turn the device on or off
	Press to confirm a selection while in setting mode Recording Mode Hot Key: Emergency Lock (Press to manually lock/unlock the video file during recording)
	Please stop recording first Press Once / Twice to switch between settings, press and hold for 3 seconds to exit the menu Press and hold for 3 seconds to switch between video recording/playback modes In Playback mode, press to switch between the four cameras

Button	Functions
	<p>Press to navigate UP through options in settings mode</p> <p>Press to start/stop video recording</p> <p>Press and hold for about 3 seconds to take a photo</p>
	<p>Press to navigate DOWN through options in settings mode</p> <p>Press to switch the image between the four cameras</p> <p>Press and hold for 3 seconds to turn the Audio recording on / off</p>

What's in the box

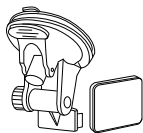

① Suction Cup and Adhesive Mount



② Packing Box

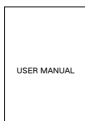

③ User Manual

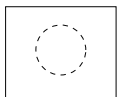

④ Windshield Electrostatic Sticker

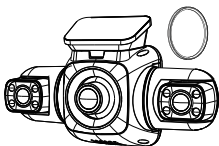

⑤ Dash Cam & CPL

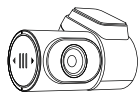

⑥ Rear Camera

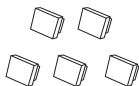

⑦ Cable Adhesive Spacer



⑧ Micro SD Card



⑨ Cable Management Tool

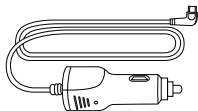

⑩ Car Power Connector

Dash Cam Installation

06

Place the dash cam on the mount carefully route the power cable around the windscreen and tuck it in under the trim.

Plug the power cord into a 12V DC power outlet or the car cigarette lighter.

Connect the power cord to the camera. The camera will auto-start recording once powered on.

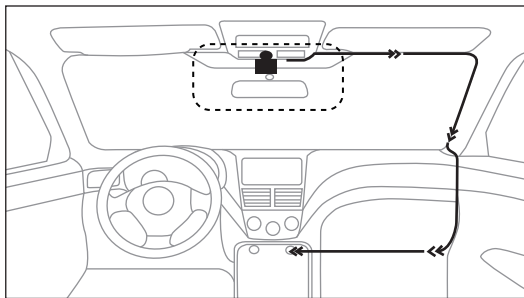

The dash cam is automatically powered on when plugged into a 12V accessory socket or cigarette lighter and receives a charge (i.e.: the vehicle is started).

To turn the device on manually, press and hold the power button until the welcome screen appears.

The camera will automatically start recording when powered on.

You will need to insert a memory card before you can begin recording. Before inserting or removing a memory card, first ensure you've powered down the dash cam. Gently push the memory card in until you hear a click, and allow the spring release to push the card out.

Power the dash cam by connecting the charger to the car cigarette lighter and dash cam. Ensure the dash cam records to your memory card properly and without error. Before you start using a new memory card, you must format the card within the camera using the format function. Always back up important data stored on the memory card before formatting.

Mount the rear camera and dash cam as shown below. Use the provided rear camera cable to connect the rear camera to the front camera.

To install the rear camera of a dash cam, follow these detailed steps:

1. Find a suitable mounting position for the rear camera, typically on the rear windscreen. Ensure that there is a clear view of the rear of the vehicle.
2. Thoroughly clean the mounting surface with an alcohol wipe to ensure proper adhesion.
3. Use the supplied 3M Adhesive Mount Kit to secure the rear camera in place.
4. Route the rear camera cable along the interior trim, headliner, and pillars towards the front of the vehicle. Use cable clips or tucks to secure the cable neatly.
5. Connect the rear camera cable to the appropriate connector on the main dashboard camera unit.
6. Adjust the angle and position of the rear camera as required for optimum viewing.
7. If the image is upside down, you can switch the rear camera mirror option on or off in the dash cam settings.
8. Secure any loose cables with cable ties or bungee cords to prevent interference with vehicle operation.

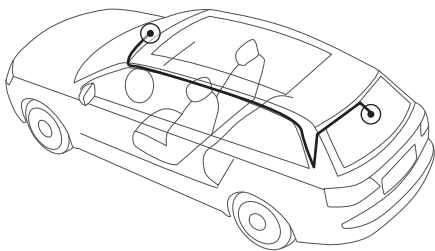

Please scan the QR code with your mobile phone or open the following URL in your browser to view the installation video for the dash cam and rear camera.



t.ly/w5JSE



STEP 1

Clean the area of the windshield where you plan to stick the 3M adhesive mount.



STEP 3

Peel off the protective film from the adhesive on the mount.

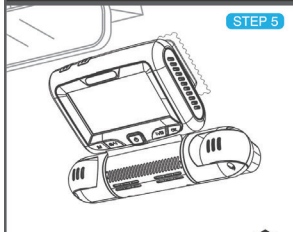

STEP 5

Try and move the mount to check for stability. Attach the dash cam to the mount and adjust the recording angle.

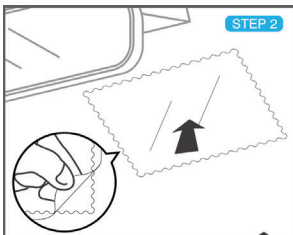

STEP 2

Attach the windshield sticker applicator included in the box to the windshield to make it easier to remove the 3M adhesive mount when the dash cam is not in use.

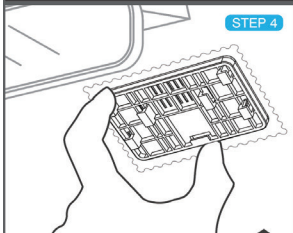

STEP 4

Press the adhesive side of the mount firmly against the windshield for about 30 seconds. Allow the adhesive to set for 2 hours before attaching the dash cam.

Suction Cup Mount Installation:

09



STEP 1

Clean the windshield area where you plan to place the suction cup mount.

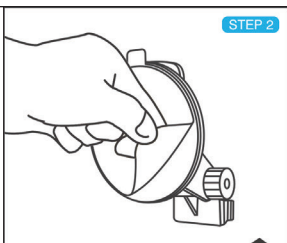

STEP 2

Peel off the plastic protective film on the suction cup mount.

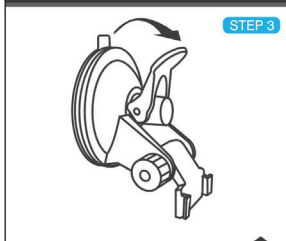

STEP 3

Ensure the locking lever is in the UP position.

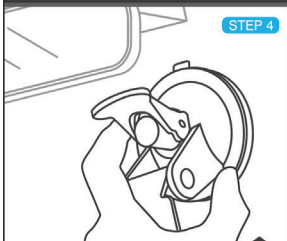

STEP 4

Press the mount's button down with good force. This is what creates the suction.

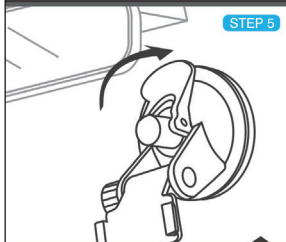

STEP 5

Rotate the mount's lever down to lock it.

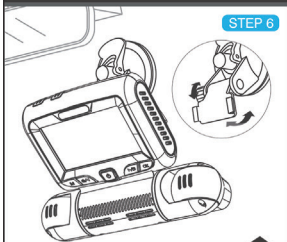

STEP 6

Try and move the mount to check for stability. Attach the dash cam to the mount and adjust the recording angle.

Your device accepts memory cards with a maximum capacity of 256 GB. Depending on the memory card manufacturer and type, some cards may not be compatible with your device. Using an incompatible card may damage the unit or the memory card, or corrupt the data stored on it.

Please face the screen of the D90-4CH Dash Cam.

- Insert a memory card with the gold-colored contacts facing you.
- Push the memory card into the slot until it clicks.

It is recommended that you reformat a memory card each time you transfer videos from it to a computer, or at least once a month.

Reformatting a memory card keeps important elements of the data and file structure clean, which helps prevent error messages and missing images. Reformatting also restores the memory card, which can help prevent it from becoming corrupted.

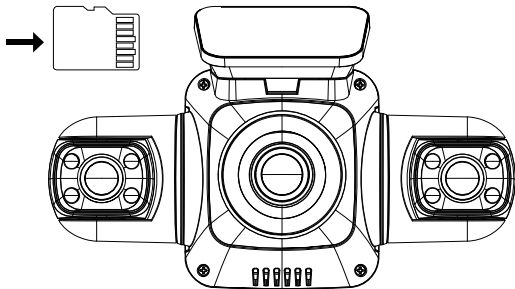

Removing the Memory Card

11

Before removing a memory card from your dash cam, you must first unmount it for safe removal.

To remove a memory card from your device

1. Press the Video Capture button to stop recording.
2. Press and hold the power button to turn off the unit.
3. Gently push in and release the memory card until it unlocks.

PLEASE DO NOT remove the memory card while the device is transferring or accessing information. Doing so may result in data loss, corruption, or damage to the memory card or device. PRUVEEO is not responsible for any loss, including loss of data, resulting from the use of damaged memory cards.

Formatting the Memory Card

12

1. Press the Video Record button to stop the device from recording.
2. Press the MENU button twice to enter the General Settings.
3. Press the DOWN button to navigate to the Format options.
4. Press OK to format the SD card.

Please format the card on the dash cam before using it. Before formatting a memory card, always remember to make backup copies of all important data stored on the device. The manufacturer's warranty does not cover loss of data due to user actions.

Camera Resolution

All four cameras have FHD 1080P (1920 x 1080P) resolution.

Loop Recording

When Loop Recording mode is enabled, the unit continuously erases older video while recording new video, keeping only the video captured within a user-selected time range. Any video older than this range will be replaced with a new video. (Note: any locked video files on the memory card remain protected and are not automatically deleted during loop recording).

It is recommended that you reformat a memory card every time you transfer videos from it to a computer, or at least once a month. This keeps important elements of the data and file structure clean, which helps prevent error messages and missing videos.

Remember to always make backup copies of all important data stored on the device. The manufacturer's warranty does not cover loss of data due to user actions.

1. Press MENU once to enter Video Settings.
2. Press the UP or DOWN button to navigate to the "Loop Recording" option.
3. Press OK to view the current selection: 1 minute
4. Press the UP or DOWN button to make your selection.
5. Press OK to confirm your selection.
6. Press and hold the Menu button for 3 seconds to exit.
7. It is recommended to use the 1 minute option.

Gravity Sensing

If a change in gravity is detected, such as a car crash, the G-sensor will signal the camera and an automatic file lock will be placed on the current video, preserving your most important footage.

Note: Locked video files won't be deleted by Loop Recording, they will remain on the memory card until they are manually deleted or the card is formatted.

1. Press MENU once to enter Video Settings.
2. Press the UP or DOWN button to navigate to the "Gravity Sensing" option.
3. Press OK to view the current selection High/Middle/Low/Close status
4. Press the UP or DOWN button to enable or disable this feature.
5. Press OK to confirm your entry.
6. Press and hold the Menu button for 3 seconds to exit.

Date Stamp

You have the option to display the date and time in your videos. Note that the date and time stamp cannot be removed from videos if this feature was enabled when they were recorded.

1. Press MENU once to enter the Video Settings.
2. Press the UP or DOWN button to navigate to the "Date Stamp" option.
3. Press OK to view the current selection ON/OFF status.
4. Press the UP or DOWN button to enable or disable this feature.
5. Press OK to confirm your entry.
6. Press and hold the Menu button for 3 seconds to exit.

Recording Audio

You can choose to record audio with video or turn off the microphone so that all recorded video is muted.

1. Press MENU once to enter Video Settings.
2. Press the UP or DOWN button to navigate to the "Recording Audio" option.
3. Press OK to view the current selection On/Off.
4. Press the UP or DOWN button to turn this feature on or off.
5. Press OK to confirm your entry.
6. Press and hold the Menu key for 3 seconds to exit.

Alternatively, you can use a hotkey shortcut for this function. Press and hold 7 for about 3 seconds to mute/unmute the microphone for video recording.

Exposure

Adjust the camera's exposure value to make the recorded video brighter or darker according to your preference.

1. Press MENU once to enter Video Settings.
2. Press the UP or DOWN button to navigate to the "Exposure" option.
3. Press OK to display the current selection: +0.0, +1/3, -1/3, etc.
4. Press the UP or DOWN button to make your selection.
5. Press OK to confirm your selection.
6. Press and hold the Menu button for 3 seconds to exit.

Light Frequency

This option should be set according to the power supply specification used in your country or geographical region (U.S. users should select the "60Hz" option).

1. Press MENU once to enter the Video Settings.
2. Press the UP or DOWN button to navigate to the "Light Frequency" option.
3. Press OK to display the current selection: 50Hz / 60Hz
4. Press the UP or DOWN button to change your selection.
5. Press OK to confirm your selection.
6. Press and hold the Menu button for 3 seconds to exit.

Format

Performing this operation will format the memory card and erase all files.

Note: Locked video will also be deleted, so make sure you have backed up your important footage before formatting the card.

Please format your micro SD card on the dash cam before using it.

1. Press the Video Capture button to start recording first.
2. Press the MENU button twice to enter the general settings.
3. Press the DOWN button to navigate to the "Format" option.
4. Press OK to format the SD card.
5. Press and hold the Menu button for 3 seconds to exit.

Screen Saver

Select a time for the screen to remain lit after the recording starts.

1. Press MENU twice to display the General Setup screen.
2. Press the UP or DOWN button to navigate to the "Screen Saver" option.
3. Press OK to display the current selection: 1 min / 3 min / OFF
4. Press the UP or DOWN button to make your selection.
5. Press OK to confirm your selection.
6. Press and hold the Menu button for 3 seconds to exit.

Alternatively, you can use a hotkey shortcut for this function. While in Capture mode, press the Power button to turn on/off the LCD screen.

Language

Use the following procedure to change the language of the unit.

1. Press MENU twice to enter General Settings.
2. Press the UP or DOWN button to navigate to the "Language" option.
3. Press OK to display the current language selection.
4. Press the UP or DOWN button to change the selection.
5. Press OK again to confirm your selection.
6. Press and hold the Menu button for 3 seconds to exit.

Parking Monitor (Parking Mode)

Parking Mode allows you to monitor your parked vehicle. When the engine is turned off, a hardwire kit is used to provide continuous power and protect your car battery from draining.

1. Press MENU twice to enter General Settings
2. Press the UP or DOWN button to navigate to the "Parking Monitor" option.
3. Press OK to view the current selection: Off / Gravity Sensing/ Time Lapse.
4. Press OK to confirm.
5. Press UP or DOWN button to change your selection.
6. Press OK to confirm your selection.
7. Press and hold the Menu button for 3 seconds to exit.

To use the Parking Mode feature, you must also use the ACC Hardwire Kit. Please search for and purchase the "PRUVEEO ACC Hardwire Kit" on Amazon.com.

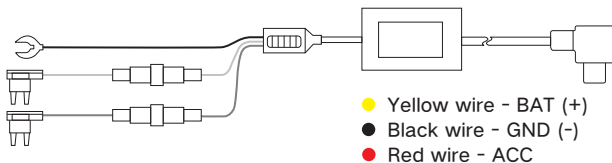

Warm Tips:

When installing the ACC hardwire kit, please refer to the actual product.

Automatic Parking Mode. The ACC (ignition-switched) detection feature will allow the dash cam to switch to parking mode automatically if the vehicle's engine turns off and switch back to normal recording after the vehicle's engine turns on.

Regarding the installation of the ACC hardwire kit, if you need more information, please search for "acc hardwire kit parking mode" on YouTube.com.

You are welcome to show us your Fuse Schematics by email asking for our help if you have difficulties in the HWK installation.

※ **There are 2 options under parking mode, we recommend using the Time Lapse option.**

• Time Lapse Recording:

Record video in one frame per second to conserve memory and reduce the time it takes to review video.

- Gravity Sensing Record:

The Gravity Sensing detects significant or sudden movement (such as an impact or collision), and it will trigger an event recording. We suggest setting the "Gravity Sensing" to High sensitivity for parking mode Recording.

✖ **If you do not use the parking mode function, please change "Gravity Sensing" to LOW sensitivity. Otherwise, the dash cam will easily lock the video and cannot be deleted by the loop recording function. This will cause the memory card to be full of locked videos and cause the recorder to fail normal work.**

Time-lapse Recording

Time-lapse is a creative filming and video editing technique that manipulates the way the frame rate is captured. ... In most videos, the frame rate and playback speed are the same. In a time-lapse video, the frame rate is stretched much more: when played back at average speed, time appears to be speeding up.

Record video at one frame per second to conserve memory and reduce the time it takes to review the video.

All the Time-lapse recordings are saved in the VIDEO folder. These video files have images but without sound.

Caution

When you DO NOT use the parking monitoring function, please turn off this option, otherwise, the recorded video will be in fast-forward mode.

1. Press MENU twice to enter General Settings
2. Press the UP or DOWN button to navigate to the "Parking Monitor" option
3. Press OK to view the current selection: Off / Gravity Sensing/ Time Lapse
4. Press the UP or DOWN button to to select the OFF option
5. Press OK to confirm your entry
6. Press and hold the Menu button for 3 seconds to exit

Please scan the QR code with your mobile phone or open the following URL in your browser to view the installation video for the ACC hardwire kit.



t.ly/21NNu

IR LED

Use the following procedure to turn the infrared lights on or off.

1. Press MENU twice to access General Settings.
2. Press the UP or DOWN button to navigate to the "IR LED" option.
3. Press OK to confirm your entry.
4. We recommend to use the Auto option.
5. Press and hold the Menu button for 3 seconds to exit.

System Volume

Increase or decrease the volume of your dash cam.

1. Press MENU twice to enter General Settings.
2. Press the UP or DOWN button to navigate to the "System Volume" option.
3. Press OK to display the current selection High/Middle/Low/Close
4. Press OK to confirm your selection.
5. Press and hold Menu for 3 seconds to exit.

Key Sound

Allows you to turn the device's button sound effect on or off.

1. Press MENU twice to enter General Setup.
2. Press the UP or DOWN button to navigate to the "Key Sound" option.
3. Press OK to see the current selection On/Off.

4. Press the UP or DOWN button to turn this feature on or off.
5. Press OK to confirm your entry.
6. Press and hold the Menu button for 3 seconds to exit.

Date and Time

Use the following procedure to change the time and date of the unit.

1. Press MENU twice to enter General Settings.
2. Press the UP or DOWN button to navigate to the "Date and Time" option.
3. Press OK to display the date/time in the format YYYY/MM/DD HH:MM:SS.
4. Press the UP or DOWN key to change the highlighted number.
5. Press OK to move to the next date/time segment and repeat step 4.
6. Press OK again to confirm your entry.
7. Press the Menu button to exit the date and time setting.
8. Press and hold the Menu button for 3 seconds to exit.

Set Time Zone

Updates the time automatically with your time zone.

1. Press MENU twice to enter General Settings
2. Press the UP or DOWN button to navigate to the "Set Time Zone" option
3. Press OK to view the current selection
4. Press the UP or DOWN button to make your selection
5. Press OK to confirm your entry
6. Press MENU to exit settings

Daylight Saving

Enable / Disable Daylight Saving Time

1. Press MENU twice to enter General Settings
2. Press the UP or DOWN button to navigate to the "Daylight Saving" option
3. Press OK to view the current ON/OFF status for this feature

4. Press the UP or DOWN button to enable or disable this feature
5. Press OK to confirm your entry
6. Press MENU to exit settings

GPS Speed Unit

Select GPS speed unit (built-in GPS logger)

1. Press MENU button twice to enter General Settings
2. Press the UP or DOWN button to navigate to the "GPS Speed Unit" option
3. Press OK to view the current selection: KM/H / MP/H / OFF
4. Press the UP or DOWN button to make your selection
5. Press OK to confirm your entry
6. Press MENU to exit settings

GPS Information

1. Press MENU twice to enter General Settings
2. Press the UP or DOWN button to navigate to the "GPS Information" option
3. Press OK to view the current GPS signal status
4. Press MENU to exit

Wi-Fi

WiFi connection first when you want to operate the dash cam.

1. Press MENU twice to enter General Settings.
2. Press the UP or DOWN button to navigate to the "WiFi" option.
3. Press OK to see the current ON/OFF status of this feature.
4. Press the UP or DOWN button to change your selection.
5. Press OK to confirm your selection.
6. Press MENU to exit settings.

Alternatively, you can use a hotkey shortcut for this feature. Press and hold OK for about 3 seconds to turn the WiFi feature on/off.

Wi-Fi Connection Guide

With the dash cam's built-in Wi-Fi, you can change the dash cam's settings and play and download recorded video using the APP on your cell phone.

If you want to see the GPS track of the video, please download the video to your phone first, then the GPS track will be displayed.

The effective working distance of Wi-Fi is 5 meters.

Downloading the Wi-Fi App

- The Wi-Fi app is available for free download from the Apple App Store™ and Google Play Store™.

- Android users: Go to the Google Play Store™, search for GFG CAM, download and install, and follow these instructions to connect and operate the Wi-Fi.

- iPhone users: Enter the Apple App Store™, search for GFG CAM, download and install, follow this user guide to connect the Wi-Fi and operate.

To pair the camera with your device

1. Turn on the camera, please stop recording first by pressing the Video Recording button, then you can operate other buttons, please press and hold the OK button for about 3 seconds to start the Wi-Fi function, you can also start the Wi-Fi function in the menu.

2. The LCD screen will display the Wi-Fi SSID and password.

3. Search for a Wi-Fi hotspot on your smartphone/tablet, select the network and you will be prompted for a password; enter '12345678' to proceed, once connected, only the Wi-Fi function key can be used, press and hold the Wi-Fi key to exit the Wi-Fi function.

4. Open the GFGCAM application on your smartphone/tablet.



You can also scan the QR code to download the GFGCAM APP

Restore Factory Settings

Performing this operation will reset all of your device's settings to their original values. Note: All custom settings will be lost.

1. Press MENU twice to access General Settings.
2. Press the UP or DOWN button to navigate to the "Restore Factory Settings" option.
3. Press OK to display YES / NO confirmation for this operation.
4. Press the UP or DOWN key to make your selection.
5. Press OK to confirm your selection.
6. Press and hold the Menu button for 3 seconds to exit.

Video Playback

You can play videos on a device or a computer.

To play a video on the computer, either use an SD card adapter. To play a video using an SD card adapter, remove the memory card and insert it into an SD card adapter. Insert the adapter into the computer.



event



park



photo



version



video

Event folder: Used to store the gravity-sensitive locked video files.

Park folder: Used to store the video files for parking monitoring.

Photo folder: Used to store the photos.

Version folder: Used to store the system files, please do not delete it.

Video folder: Used to store the video files recorded by the dash cam.



FRONT



LEFT



REAR



RIGHT

The video files and photos recorded by the four cameras of the Dash Cam are stored in the four folders above.

To play a video on the device, first stop recording and press and hold the M button to switch to Playback mode. Use the UP and DOWN buttons to scroll to the desired video. Press the OK button to play. During playback, use the OK (pause), UP (press and hold to rewind), and DOWN (press and hold to fast forward) buttons to control the video playback.

GPS Video Playback

You can play back your recordings in a special application that lets you view speed and location information along with your footage.

Windows:

Please download the software from the following official website:
<https://pruveeo.us/pages/download>

Mac OS:

Visit the Apple App Store™, search for 'GXPlayer', download and install.

Access Video Files:

Insert the micro SD card into your computer to access the video files.

To open a GPS video file:

1. Once you've opened the application, navigate to the top menu bar and click File > Open to browse your files.
2. Browse to the video file you want to add to the playback queue, select it, and click Open to load it into the application. You can also select multiple videos at once.

3. After a short loading time, the (first) video should start playing automatically, with real-time speed and location information displayed in the right panels.



Warm Tips:

After many analyses, we found that most of the dash cam problems are caused by the card, because the speed and number of erasing and writing of the memory card cannot meet the requirements.

Therefore, we recommend our High Endurance 128GB or 256G MicroSDXC memory card for this car dash cam, which can make the D90-4CH car dash cam more stable, reliable and work continuously for a long time.

128G Link: www.amazon.com/dp/BOC1NL4BS8

256G Link: www.amazon.com/dp/BOC1NN48HT

***PLEASE DO NOT USE "Generic Class 10" cards from third party suppliers. They are NOT made for 4 channel recording dash cam.**

ACTIVATE AND GET TWO YEARS WARRANTY



Scan the QR code or visit
pruveeo.com/pages/wty to learn more.

**Contact us here, we have professional
customer service!**

Official Website: <http://pruveeo.us>

Email: support@pruveeo.us

If you have any questions, please feel free to contact us at



Email



Official Site