

Welcome Guide

Desk Lamp

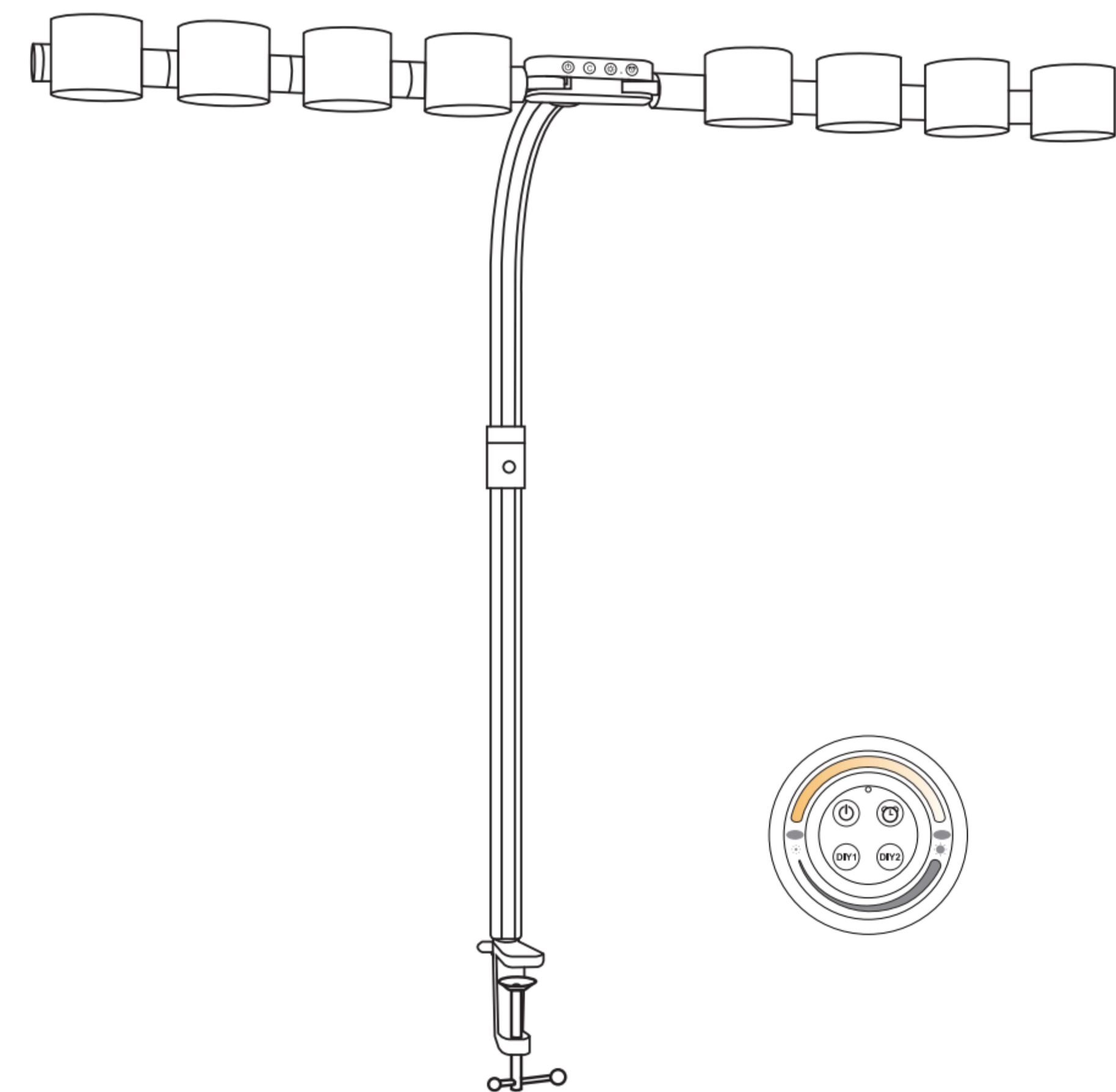

Model: FDDL25-R

Flexible Rotatable Office Lamp

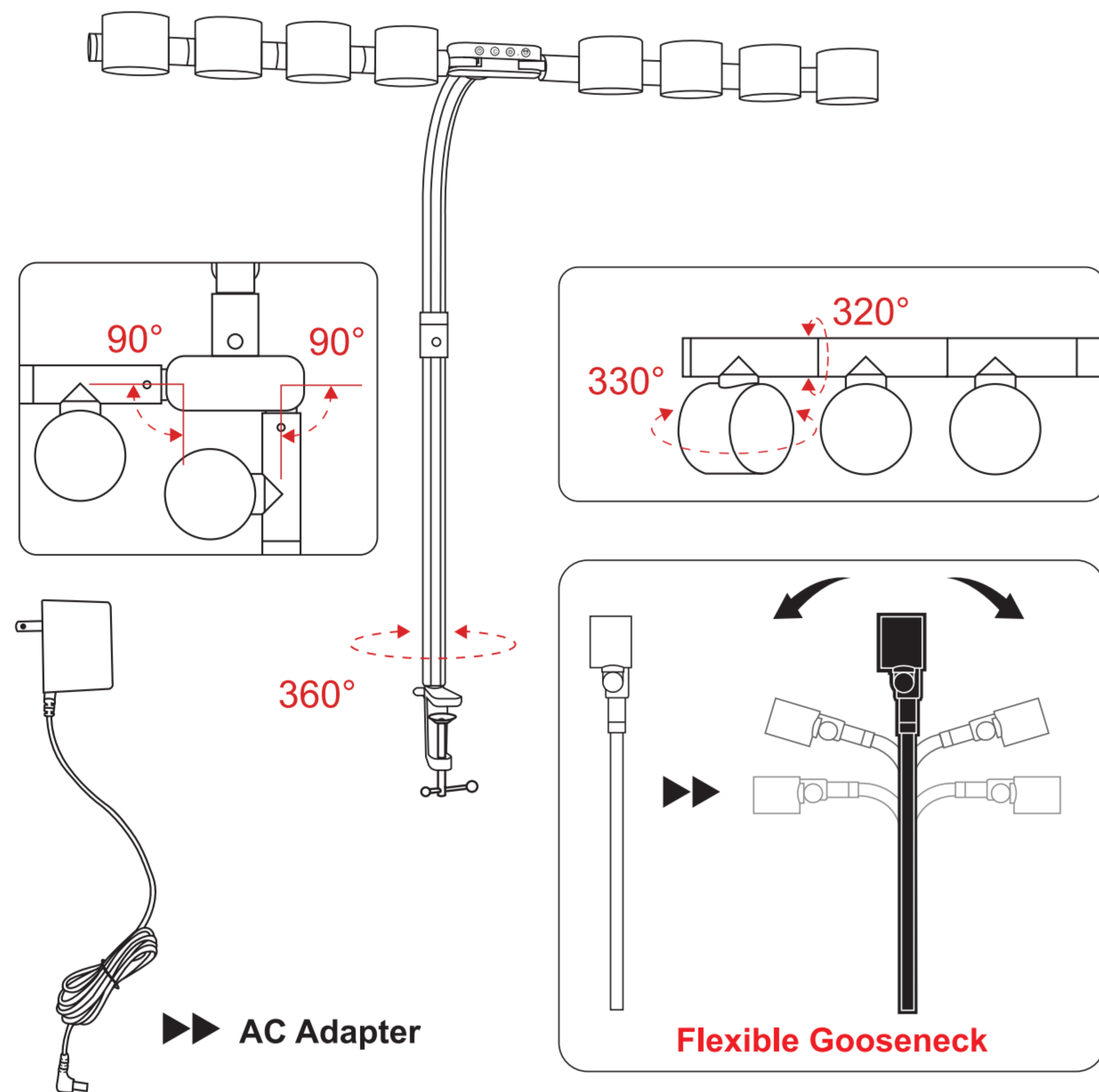

01

Installation Guide

- 1.Assemble Pole:** Align and join pole sections firmly at the interface.
- 2.Secure Pole to Clamp:** Insert assembled pole into clamp; fasten with provided screw.
- 3.Install the clamp:** Place clamp on desk edge and tighten rotating screw to secure.**Note: Desk thickness must not exceed 1.96 in (approx. 5 cm).**
- 4.Attach Lamp Head:** Insert lamp head into pole top socket until secure.
- 5.Power On:** Connect adapter to lamp base and outlet as picture5 and picture6; press switch to operate.

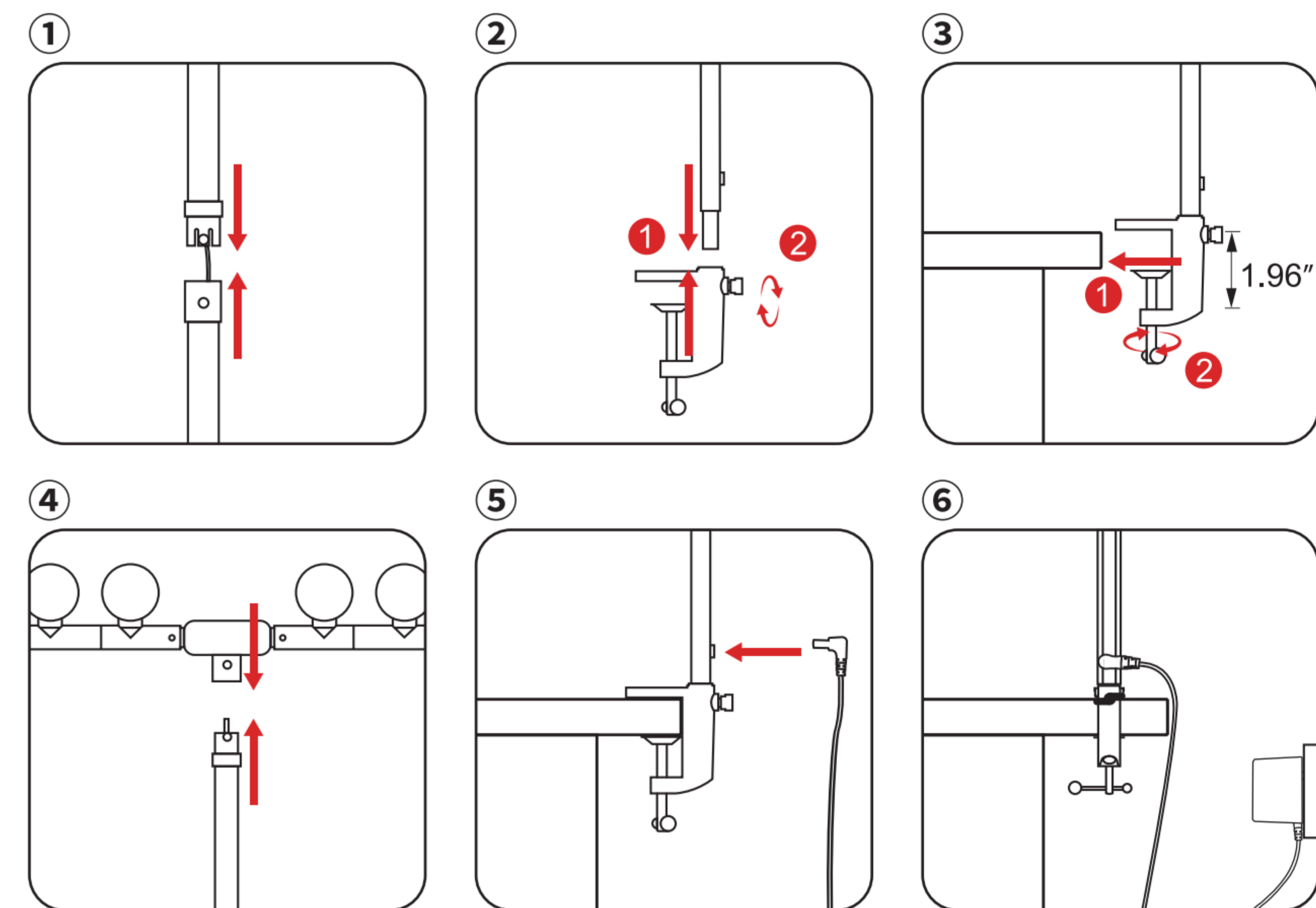

02

Specifications

Model	FDDL25-R
Power	22W
CCT	3000K-6500K
Input	100-240V~50/60Hz
Output	24V1A

Touch Control Panel









	Switch: Click on/off.
	Color Temperature: 1.Click to adjust the color temperature of 5 levels. (3000k-3500k-4000k-5000k-6500k) 2.Long press for stepless tempering.(3000k-6500k)
	Brightness: 1.Click to adjust the brightness of 5 levels.(20%-40%-60%-80%-100%) 2.Long press for stepless dimming.(10%-100%)
	Desk Lamp Indicator Light: It will light up after the timer is set,and it will be blue when illuminated.
	Timer: 1.Click to set a timer for 30 minutes, the desk lamp will flash once and the desk lamp indicator light will start to breath. 2.Click again to cancel the timer,the indicator light will turn off.

03



Remote control

	Switch: Click on/off.
	Timer: 1. Click to set a timer for 30 minutes, the desk lamp will flash once and the desk lamp indicator light will start to breath. 2. Click again to cancel the timer, the desk lamp indicator light will turn off.
 	DIY1/DIY2: 1. Save Custom Mode: Press and hold the DIY1 or DIY2 button for 1 second to save the current light settings (brightness and color). The light will flash twice to confirm successful saving. You can customize and overwrite these modes repeatedly according to your preference. 2. Activate Custom Mode: Simply click the corresponding DIY1 or DIY2 button to instantly switch to your saved custom light setting.
	Color Temperature Slider: 1. Swipe left or right to continuously adjust the color temperature (3000K–6500K). 2. Click any point on the slider to adjust the color temperature.
	Brightness Slider: 1. Swipe left or right to continuously adjust the brightness (10%-100%). 2. Click any point on the slider to adjust the brightness.
	Remote Control Indicator Light: 1. The indicator light will illuminate each time you press a button on the remote control. 2. A red light indicates low battery power in the remote control.

04

Pairing: Press and hold  button within 3 seconds after inserting the DC male connector of the adapter into the light pole, and the desk lamp will flash once to indicate that the pairing is successful. (After pairing, other RF signals cannot interfere with and control this desk lamp, but this desk lamp remote control can control other desk lamps)

Unpairing: Press and hold  button within 3 seconds after inserting the DC male connector of the adapter into the light pole. and the lamp will flash 3 times to indicate that the unpairing is successful.

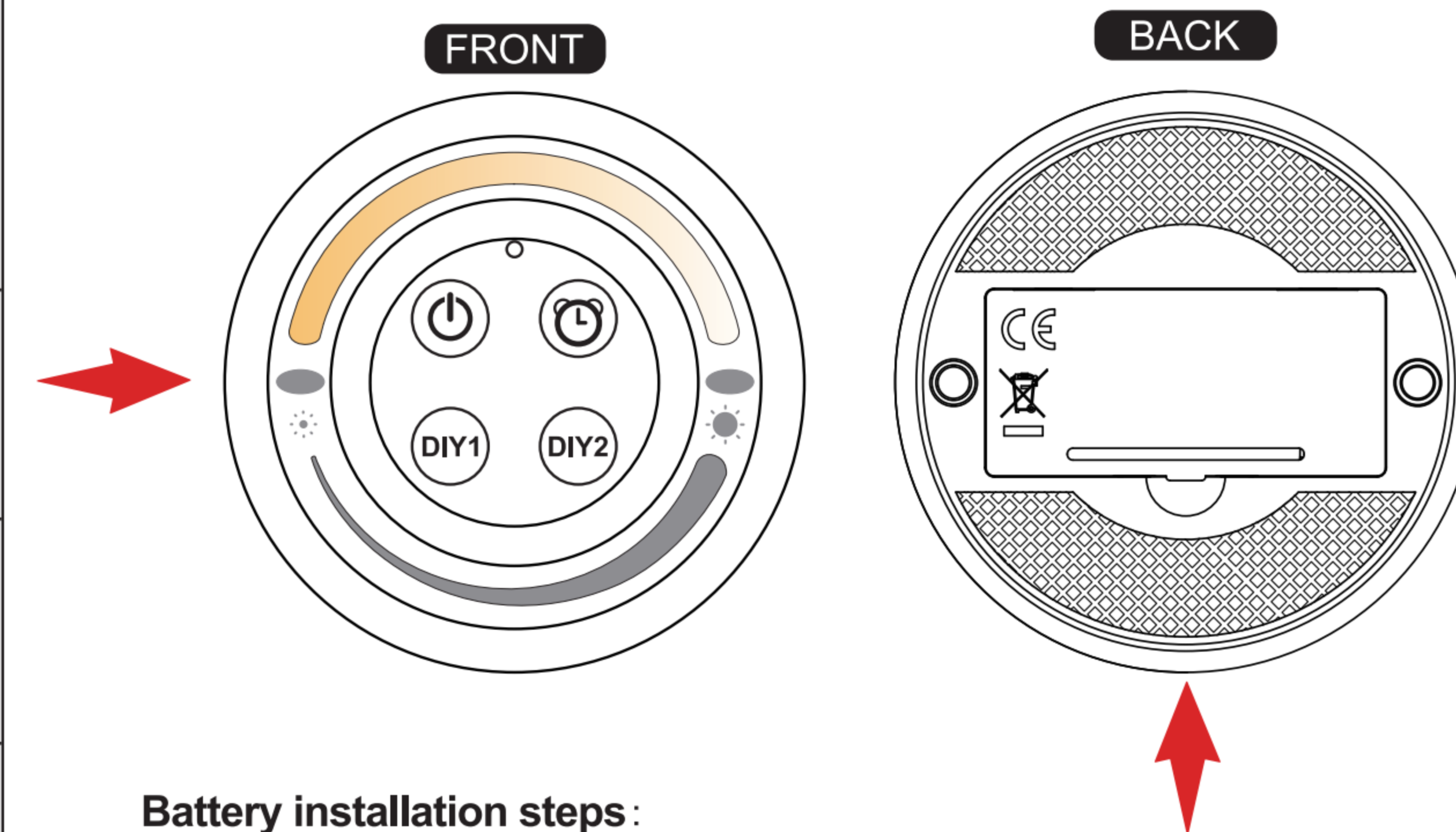

Battery installation steps :

Open the battery cover and inset 2 new batteries (AAA battery). Pay attention to the direction of the positive and negative poles.

05

Lamp Size

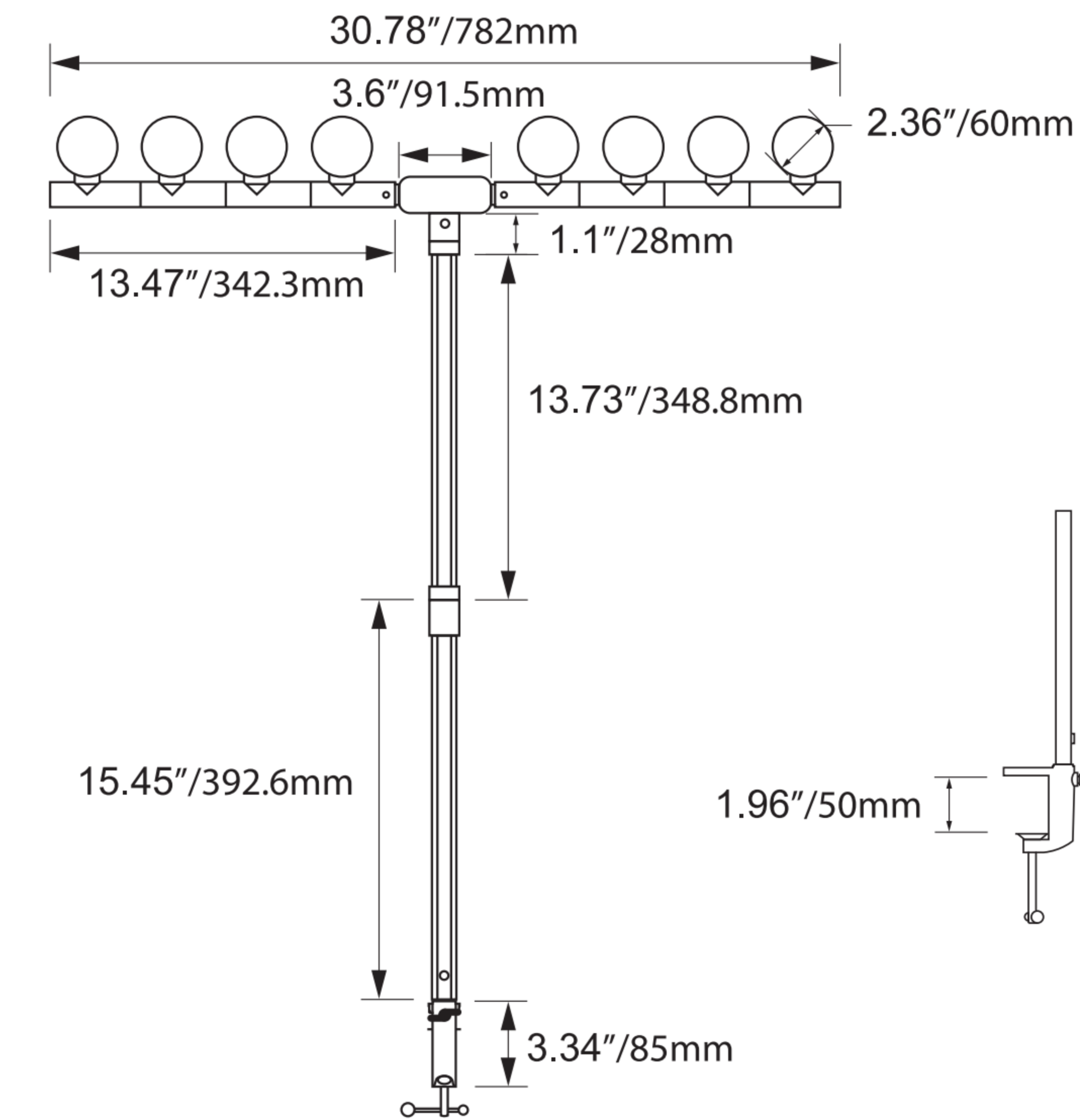

06

Attention

1. Keep the lamp away from heat sources.
2. Do not immerse appliance, cords or plugs in water or other liquid to avoid electric shock;
3. Do not look at the LEDs directly to avoid damage to eyes;
4. Please do not remove the power plug with wet hands as it may cause electrical shock;
5. Any repairs to this appliance should be carried out by a qualified service person;
6. Under no circumstances should this appliance be modified.

FCC Caution: Any changes or modifications not expressly approved by the party responsible for compliance could void the user's authority to operate this equipment.

This device complies with Part 15 of the FCC Rules. Operation is subject to the following two conditions:

- (1) This device may not cause harmful interference.
- (2) This device must accept any interference received, including interference that may cause undesired operation.

NOTE:

This equipment has been tested and found to comply with the limits for a Class B digital device, pursuant to Part 15 of the FCC Rules.

These limits are designed to provide reasonable protection against harmful interference in a residential installation. This equipment generates, uses and can radiate radio frequency energy and, if not installed and used in accordance with the instructions, may cause harmful interference to radio communications.

However, there is no guarantee that interference will not occur in a particular installation. If this equipment does cause harmful interference to radio or television reception, which can be determined by turning the equipment off and on, the user is encouraged to try to correct the interference by one or more of the following measures:

- Reorient or relocate the receiving antenna.
- Increase the separation between the equipment and receiver.
- Connect the equipment into an outlet on a circuit different from that to which the receiver is connected.
- Consult the dealer or an experienced radio/TV technician for help.

07