

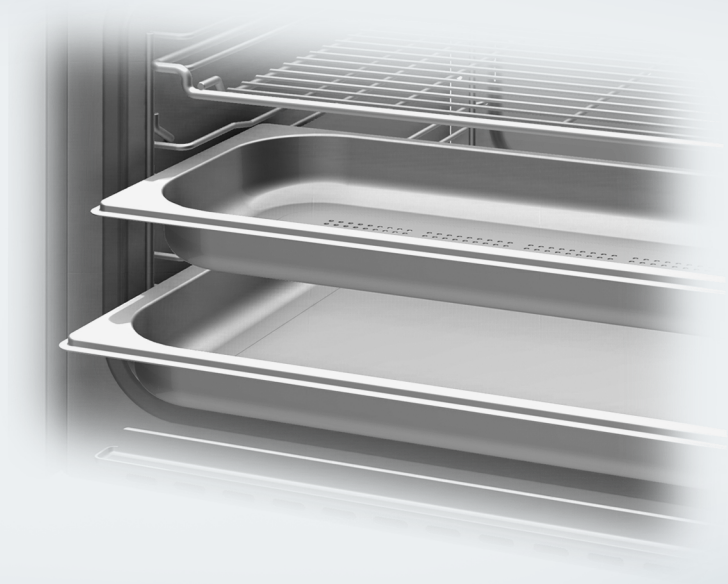

Operating and installation instructions Steam oven with microwave



To avoid the risk of accidents or damage to the appliance it is **essen-
tial** to read these instructions before it is installed and used for the
first time.

Contents

Warning and Safety instructions	7
Caring for the environment	19
Guide to the appliance	20
Steam oven	20
Accessories supplied	21
Controls	23
On/Off sensor control	24
Display	24
Sensor controls	24
Symbols	26
Using the appliance	27
Selecting a menu option	27
Changing a setting in a list	27
Changing the setting with a segment bar	27
Selecting a function or operating mode	28
Entering numbers	28
Entering letters	28
Activating MobileStart	29
Description of functions	30
Steam cooking mode	30
Water container	30
Temperature	30
Cooking duration	30
Noises	30
Heating-up phase	31
Cooking phase	31
Steam reduction	31
Microwave power	32
How it works	32
Selecting crockery	32
Glass tray	37
Oven interior lighting	37
Before using for the first time	38
Miele@home	38
Basic settings	39
Cleaning for the first time	40
Set the correct boiling point for water	41

Settings	42
Settings overview	42
Opening the “Settings” menu.....	44
Language 	44
Time.....	44
Date	45
Lighting.....	45
Display.....	45
Volume.....	46
Units	46
Quick MW.....	47
Popcorn.....	47
Keeping warm function	47
Steam reduction	48
Recommended temperatures.....	48
Recommended power levels.....	48
Water hardness	49
Safety	50
Miele@home	51
Remote control.....	52
Activating MobileStart	52
RemoteUpdate	52
Software version.....	53
Showroom programme.....	53
Factory default.....	54
Minute minder	55
Main and sub-menus	57
Operation	59
Changing values and settings for a cooking programme.....	60
Changing the temperature.....	61
Changing the microwave power level	61
Setting cooking durations	62
Changing the set cooking durations	63
Deleting the set cooking durations.....	63
Interrupting the cooking process for functions which use microwave power.....	64
Interrupting the cooking process for functions involving steam	64
Cancelling a cooking programme	65
Quick MW and Popcorn	66

Contents

General notes on steam cooking	68
The advantages of cooking with steam	68
Suitable containers.....	68
Glass tray	68
Shelf level	69
Frozen food.....	69
Temperature	69
Cooking duration	69
Cooking with liquid.....	69
Your own recipes	69
Steam cooking	70
Eco Steam cooking	70
Notes on the cooking tables	70
Vegetables.....	71
Fish.....	74
Meat	77
Rice	79
Grain	80
Pasta	81
Dumplings	82
Dried pulses	83
Hen's eggs	85
Fruit	86
Sausages.....	86
Shellfish	87
Mussels	88
Menu cooking (cooking whole meals).....	89
Sous-vidé (vacuum) cooking	91
Further applications	99
Reheating with steam.....	99
Defrosting with steam	102
Blanching.....	105
Bottling	105
Disinfect items	108
Prove dough	108
Heating damp flannels	109
Dissolve gelatine	109
Decrystallise honey	110
Melt chocolate.....	110
Make yoghurt	111
Cook bacon.....	112

Sweat onions.....	112
Extracting juice with steam	113
Skinning vegetables and fruit.....	114
Apple storage	114
Making eierstich	114
Rapid steam cooking	115
Cooking new potatoes (waxy)	116
Cooking rice	117
Microwave defrosting and reheating.....	118
Defrost	119
Reheat	123
Automatic programmes	127
Categories	127
Using automatic programmes	127
User programmes.....	128
Note for test institutes	131
Cleaning and care	134
Cleaning the steam oven front	135
Cleaning the oven compartment.....	136
Cleaning the water container	136
Accessories	136
Cleaning the side runners.....	137
Maintenance.....	137
Descaling the steam oven	137
Soak	138
Problem solving guide	139
Optional accessories	144
Service.....	145
Contact in the event of a fault	145
Warranty	145
Installation.....	146
Safety instructions for installation	146

Contents

Building-in dimensions	147
Installation in a tall unit.....	147
Installation in a base unit.....	148
Side view	149
Connection and ventilation.....	150
Installing the steam oven.....	151
Electrical connection	152
Conformity declaration	154



Warning and Safety instructions

The steam oven with microwave is referred to in the following instructions as a steam oven.

This steam oven complies with all applicable safety requirements. Inappropriate use can, however, lead to personal injury and material damage.

Read the operating and installation instructions carefully before using the steam oven. They contain important information on safety, installation, use and maintenance. This prevents both personal injury and damage to the steam oven.

In accordance with standard IEC/EN 60335-1, Miele expressly and strongly advises that you read and follow the instructions in the chapter on installing the steam oven as well as the safety instructions and warnings.

Miele cannot be held liable for injury or damage caused by non-compliance with these instructions.

Keep these instructions in a safe place and pass them on to any future owner.

Warning and Safety instructions

Correct application

▶ This steam oven is intended for use in domestic households and similar working and residential environments.

▶ This steam oven is not intended for outdoor use.

▶ The steam oven is intended for domestic use only to steam-cook, defrost, reheat and cook food.

All other types of use are not permitted.

▶ Fire hazard due to flammable materials.

If flammable items are dried using microwave power, the moisture in the items will evaporate. This could cause the materials to dry out and possibly self-ignite.

Never use the steam oven to store or dry items which could ignite easily.

▶ The steam oven can only be used by people with reduced physical, sensory or mental capabilities, or lack of experience and knowledge, if they are supervised whilst using it, or have been shown how to use it in a safe way and recognise and understand the consequences of incorrect operation.

▶ The oven compartment is equipped with special lamps to cope with particular conditions (e.g. temperature, moisture, chemical resistance, abrasion resistance and vibration). These special lamps must only be used for the purpose for which they are intended. They are not suitable for room lighting. Replacement lamps may only be fitted by a Miele authorised technician or by the Miele Customer Service Department.

Safety with children

- ▶ Activate the system lock to ensure that children cannot switch on the steam oven inadvertently.
- ▶ Children under 8 years of age must be kept away from the steam oven unless they are constantly supervised.
- ▶ Children aged 8 and older may only use the steam oven without supervision if they have been shown how to use it in a safe manner. Children must be able to understand and recognise the possible dangers caused by incorrect operation.
- ▶ Children must not be allowed to clean the steam oven unsupervised.
- ▶ Please supervise children in the vicinity of the steam oven and do not let them play with it.
- ▶ Risk of suffocation due to packaging material. Whilst playing, children may become entangled in packaging material (such as plastic wrapping) or pull it over their head, presenting the risk of suffocation. Keep packaging material away from children.
- ▶ Risk of injury caused by hot surfaces and steam. Children's skin is far more sensitive to high temperatures than that of adults. During operation, steam will escape out of the ventilation outlet. The door glass and control panel of the steam oven heats up. Do not let children touch the steam oven when it is in operation. Keep children well away from the steam oven until it has cooled down and there is no danger of injury.
- ▶ Risk of injury from the open door. The oven door can support a maximum weight of 8 kg. Children could injure themselves on an open door. Do not let children sit on the open door, lean against it or swing on it.

Warning and Safety instructions

Technical safety

- ▶ Unauthorised installation, maintenance and repairs can cause considerable danger for the user. Installation, maintenance and repairs must only be carried out by a Miele authorised technician.
- ▶ Radiation by microwaves:
Service or repairs which necessitate the removal of any casing must only be carried out by a suitably trained service technician.
- ▶ Never use a damaged steam oven. It could be dangerous. Check it for visible signs of damage before using it.
- ▶ Check the door and door seal for any sign of damage. If any damage is noticed, the oven should not be used again in Microwave mode until the fault has been rectified by a service technician.
- ▶ Operating a damaged steam oven can result in microwave leakage and present a hazard to the user. Do not use the steam oven if:
 - the door is warped
 - the front of the oven compartment is dented or bowed
 - the door hinges are loose
 - holes or cracks are visible in the casing, the door or the oven compartment interior walls
 - there is moisture between the door panes
- ▶ Reliable and safe operation of this steam oven can only be assured if it has been connected to the mains electricity supply.
- ▶ The electrical safety of this appliance can only be guaranteed when correctly earthed. It is essential that this standard safety requirement is met. If in any doubt please have the electrical installation tested by a qualified electrician.

Warning and Safety instructions

▶ Before connecting the appliance to the mains supply, ensure that the connection data on the data plate (voltage and frequency) match the mains electricity supply.

This data must correspond in order to avoid the risk of damage to the appliance. Consult a qualified electrician if in any doubt.

▶ Do not connect the steam oven to the mains electricity supply by a multi-socket adapter or an extension lead. These do not guarantee the required safety of the appliance (fire hazard).

▶ For safety reasons, this steam oven may only be used when it has been built in. This is necessary to ensure that all electrical components are shielded.

▶ This steam oven must not be used in a non-stationary location (e.g. on a ship).

▶ Never open the casing of the appliance. Tampering with electrical connections or components and mechanical parts is highly dangerous to the user and can cause operational faults.

▶ While the appliance is under warranty, repairs should only be undertaken by a Miele authorised service technician. Otherwise the warranty is invalidated.

▶ Miele can only guarantee the safety of the appliance when genuine original Miele replacement parts are used. Faulty components must only be replaced by Miele spare parts.

▶ If the plug is removed from the connection cable or if the cable is supplied without a plug, the appliance must be connected to the electrical supply by a suitably qualified electrician.

▶ If the connection cable is damaged, it must be replaced with a special connection cable (see “Electrical connection”).

▶ During installation, maintenance and repair work, the appliance must be disconnected from the mains electricity supply.

Warning and Safety instructions

▶ If the steam oven is installed behind a furniture front (e.g. a door), do not close the furniture front while the steam oven is in use. Heat and moisture can build up behind the furniture front when closed. This can result in damage to the steam oven, the housing unit and the floor. Leave the furniture door open until the steam oven has cooled down completely.

▶ In areas which may be subject to infestation by cockroaches or other vermin, pay particular attention to keeping the appliance and its surroundings clean at all times. Any damage caused by cockroaches or other vermin will not be covered by the warranty.

Correct use

▶ Risk of injury caused by hot surfaces and steam. The steam oven gets hot during operation. You could burn yourself on the oven compartment, side runners, accessories, food or steam.

Wear oven gloves when placing hot food in the oven or removing it and when adjusting oven shelves, for example, in a hot oven compartment.

▶ Risk of injury caused by hot food.

Food may spill or splash around when placing it into the oven or removing it. The food can cause burns.

When placing cooking containers into the oven or removing them, make sure that the hot food does not spill.

▶ Risk of injury caused by hot water.

At the end of a cooking programme, hot water left in the steam generator is pumped back into the water container. Take care not to tip the water container when taking it out of the appliance.

▶ Do not use the steam oven to heat up or bottle food in sealed jars and tins.

Pressure will build up inside them and they can explode causing damage to the appliance, as well as the risk of injury and scalding.

▶ Plastic dishes which are not heat- and steam resistant melt at high temperatures and can damage the appliance.

Use only heat-resistant (to 100 °C) and steam-resistant plastic dishes for steam-cooking. Follow the instructions from the crockery manufacturer's instructions.

▶ Food which is stored in the oven compartment can dry out and the moisture released can lead to corrosion damage in the steam oven. Do not leave food in the oven compartment and do not use any cooking containers which are susceptible to corrosion.

▶ Risk of injury from the open door. You could bang into the open door or trip over it. Avoid leaving the door open unnecessarily.



Warning and Safety instructions

▶ The door can support a maximum weight of 8 kg. Do not sit on or lean against an open door, and do not place heavy objects on it. Also make sure that nothing can get trapped between the door and the oven cavity. The steam oven could get damaged.

▶ When using a small electrical appliance, e.g. a hand-held blender, near the steam oven, care should be taken that the cable of the appliance cannot get trapped by the steam oven door. The insulation on the cable could become damaged, giving rise to an electric shock hazard.



Microwave function

▶ Please be aware that durations when using microwave power are often considerably shorter when cooking, reheating and defrosting than when using functions without microwave power. Excessively long cooking times can lead to food drying out and burning or could even cause it to catch fire.



▶ The microwave function  is used to reheat food and beverages. Do not use the Microwave function  for drying flowers, herbs, bread or other flammable materials which could catch fire and cause injury by burning.

▶ It is important that the temperature in the food being cooked is evenly distributed and sufficiently high. This can be achieved by stirring or turning the food, and observing a sufficiently long standing time (see charts), which should be added to the time needed for reheating, defrosting or cooking. During the standing time, the temperature is distributed evenly in the food.





Warning and Safety instructions

- ▶ Risk of injury caused by hot food. When heating food up, the heat is created directly in the food itself. For this reason the crockery will remain cooler than the food (except when using oven-proof stoneware). The crockery is only warmed by the heat of the food. Before serving, always check the temperature of the actual food itself after taking it out of the oven. The temperature of the container is not an indication of the temperature of the food or liquid in it. **This is particularly important when preparing food for babies, children, and the elderly or infirm.** After reheating food, especially food for babies and small children, stir the food or shake the container and check that the temperature does not pose any danger of burning. Double check after it has been left to stand.
- ▶ The Microwave function  is not suitable for cleaning or disinfecting items because it may involve high temperatures. There is a risk of burning when items are removed from the oven.
- ▶ Risk of injury from increased pressure in closed containers or bottles. Pressure can build up during reheating in sealed containers or bottles, causing them to explode. Never cook or reheat food or liquids in sealed containers or bottles. Open containers beforehand. In the case of baby bottles, the screw top and teat must be removed.
- ▶ When heating food, and in particular liquids, using the Microwave  function, the boiling point may be reached without the production of typical bubbles. The liquid does not boil evenly throughout. This boiling delay can result in the liquid boiling over explosively. Take care when taking the container out of the oven, as the hot liquid can cause severe scalding. Under certain circumstances, the pressure can be so high that the door opens automatically. Stir liquids well before heating. After heating, wait at least 20 seconds before removing the container from the oven compartment. In addition, a glass rod or similar item, if available, can be placed in the container during heating.

Warning and Safety instructions

- ▶ Eggs can be cooked without their shells using microwave power only if the yolk membrane has been punctured several times first. The pressure could otherwise cause the egg yolk to explode.
- ▶ Eggs in their shells will explode if cooked with microwave power, even after taking them out of the oven. They can only be cooked in their shells using the steam cooking function  or in an appropriate automatic programme. Hard-boiled eggs must not be reheated with microwave power either as they too will explode.
- ▶ Food with a thick skin or peel, such as tomatoes, sausage, potatoes and aubergines can burst when heated or cooked. Pierce or score the skin of these types of food several times to allow steam to escape.
- ▶ Do not use the microwave function  to heat up cushions or pads filled with cherry kernels, wheat grain, lavender or gel, such as those used in aromatherapy. These pads can ignite when heated even after they have been removed from the oven.
- ▶ To avoid fuelling any flames, do not open the oven door if there is smoke inside the steam oven. Interrupt the programme by switching the steam oven off and disconnecting the power plug. Do not open the door until the smoke has dispersed.
- ▶ Containers and lids with hollow handles or knobs can collect moisture in the hollow spaces. When the moisture evaporates, pressure can build up and the item can explode. If the hollow recess is sufficiently ventilated, the item can be used. Do not use crockery with hollow knobs or handles when using the Microwave  function.

Warning and Safety instructions

- ▶ Non-microwave-safe plastic dishes can sustain damage or damage the steam oven if used with the Microwave  function or with functions that use microwave power.
Do not use any crockery or cutlery made from or containing metal, aluminium foil, lead crystal glassware, temperature-sensitive plastics, wooden utensils or cutlery, metal clips, or plastic or paper-covered wire ties. Do not use bowls with milled rims, or plastic pots with the foil lid only partially removed (see the requirements specified for crockery in the section on microwave operation).
- ▶ Fire hazard due to containers made of flammable materials.
Plastic disposable containers must meet the requirements specified for crockery in the section on microwave operation.
Do not leave the steam oven unattended when heating or cooking food in disposable containers made of plastic, paper or other inflammable materials.
- ▶ Heat-retaining bags usually contain a thin layer of aluminium foil that reflects microwave radiation. This reflected energy can, in turn, cause the outer paper covering to become so hot that it ignites.
Do not use heat-retaining packaging, such as bags for grilled chicken, for warming food with functions that use microwave power.
- ▶ If the steam oven is used without food or the food is loaded incorrectly when using the microwave  function or functions that use microwave power, the steam oven can become damaged. Do not use the Microwave  function or functions that use microwave power to preheat crockery or to dry herbs. Never start the Microwave  function when the oven compartment is empty.

Warning and Safety instructions

Cleaning and care

- ▶ Risk of injury due to electric shock. The steam from a steam cleaning appliance could reach live electrical components and cause a short circuit. Do not use a steam cleaner to clean the appliance.
- ▶ Scratches on the door glass can result in the glass breaking. Do not use abrasive cleaners, hard sponges, brushes or sharp metal tools to clean the door glass.
- ▶ The side runners can be removed (see “Cleaning and care – Cleaning the side runners”). Refit the side runners correctly.
- ▶ The side runners fit into plastic bushes. Check the bushes carefully for damage. If the bushes are damaged, do not use any Microwave functions until the bushes have been replaced.
- ▶ Try to avoid the interior walls being splashed with food or liquids containing salt. If it does happen, wipe these away thoroughly to avoid corrosion to stainless steel surfaces inside the cabinet.

Accessories

- ▶ Only use genuine original Miele accessories and spare parts with this appliance. Using accessories or spare parts from other manufacturers will invalidate the warranty and Miele cannot accept liability.

Disposal of the packing material

The packaging is designed to protect the appliance from damage during transportation. The packaging materials used are selected from materials which are environmentally friendly for disposal and should be recycled.

Recycling the packaging reduces the use of raw materials in the manufacturing process and also reduces the amount of waste in landfill sites.

Disposing of your old appliance

Electrical and electronic appliances often contain valuable materials. They also contain specific materials, compounds and components, which were essential for their correct function and safety. These could be hazardous to human health and to the environment if disposed of with your domestic waste or if handled incorrectly. Please do not, therefore, dispose of your old appliance with your household waste.



Please dispose of it at your local community waste collection / recycling centre for electrical and electronic appliances, or contact your dealer or Miele for advice. You are also responsible for deleting any personal data that may be stored on the appliance being disposed of. Please ensure that your old appliance poses no risk to children while being stored prior to disposal.

Guide to the appliance

Steam oven

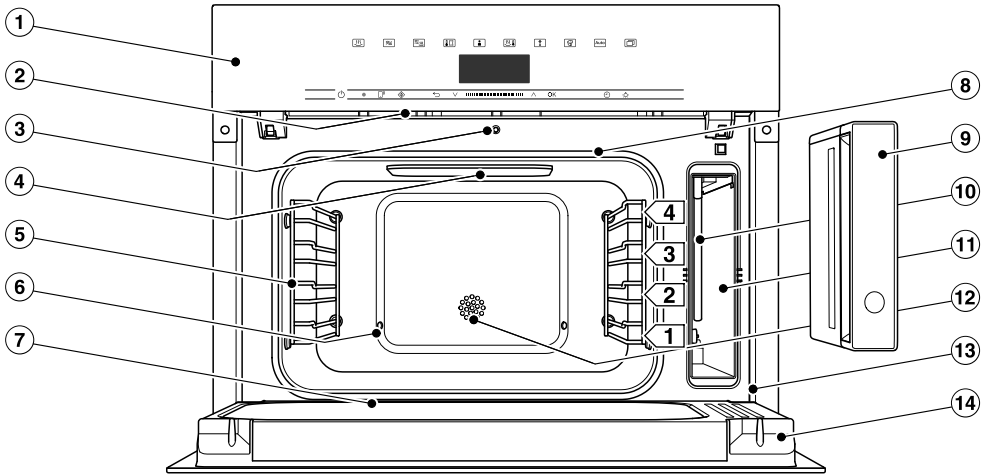

- ① Control elements
- ② Ventilation outlet
- ③ Automatic door release for steam reduction
- ④ LED oven interior lighting
- ⑤ Side runners with 4 shelf levels
- ⑥ Steam inlet
- ⑦ Drip channel
- ⑧ Door seal
- ⑨ Water container with removable spill guard
- ⑩ Suction tube
- ⑪ Compartment for water container
- ⑫ Temperature sensor
- ⑬ Front frame with data plate
- ⑭ Door

A list of the models described in these operating and installation instructions can be found on the back page.

Data plate

The data plate is located on the front frame, visible when the door is open.

The data plate states the model number, the serial number as well as connection data (voltage, frequency and maximum rated load).

Please have this information to hand, should you need to contact Miele regarding any questions or problems.

Accessories supplied

The accessories supplied with your appliance as well as a range of optional ones are available to order from Miele (see “Optional accessories”).

DMGS 1/1-30L



1 glass tray

The glass tray is suitable for use with all cooking functions.

Use the glass tray to catch dripping liquid when cooking with steam.

When using the Microwave  function, **always** use the glass tray as a surface to place containers on.

375 x 394 x 30 mm (WxDxH)

The maximum load for the glass tray is 8 kg.

The glass tray can be damaged by large temperature fluctuations.

Do not place the hot glass tray on a cold surface, such as a tiled or granite worktop. Use a suitable mat or pot rest.

Guide to the appliance

The cooking containers provided and the rack are **not** suitable for use with the Microwave  function.

DGG 1/2-40L

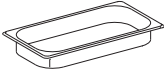

1 solid cooking container
Gross capacity 2.2 litres /
Usable capacity 1.6 litres
375 x 197 x 40 mm (W x D x H)

DGGL 1/2-40L

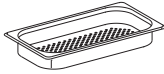

2 perforated cooking containers
Gross capacity 2.2 litres /
Usable capacity 1.6 litres
375 x 197 x 40 mm (W x D x H)

DMSR 1/1L



1 rack for placing your own crockery on

Descaling tablets

For descaling the appliance







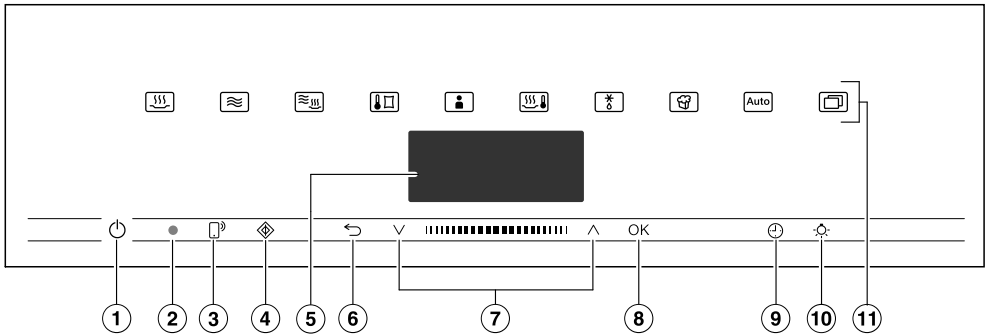

Voucher/Miele steam oven cookbook

A selection of the best recipes from the Miele test kitchen

Voucher/Miele microwave oven cookbook

A selection of the best recipes from the Miele test kitchen



- ① Recessed  On/Off sensor control
For switching the steam oven on and off
- ② Optical interface
(For Miele Service only)
- ③  sensor control
For controlling the steam oven via your mobile device
- ④  sensor control
For starting the Quick MW function
- ⑤ Display
For displaying the time of day and information on operation
- ⑥  sensor control
For going back a step and for changing menu options during a cooking programme
- ⑦ Navigation area with  and  arrow buttons
For scrolling through lists and for changing values
- ⑧ **OK** sensor control
For selecting functions and saving settings
- ⑨  sensor control
For setting a minute minder, the cooking duration or the start or end time for the cooking programme
- ⑩  sensor control
For switching the oven interior lighting on and off
- ⑪ Sensor controls
For selecting functions, automatic programmes and settings

Controls

On/Off sensor control

The  On/Off sensor control is recessed and reacts to touch.

Use this sensor control to switch the steam oven on and off.

Display

The display is used for showing the time of day or information about functions, temperatures, cooking durations, automatic programmes and settings.

After switching the steam oven on with the  On/Off sensor control, the main menu will appear, prompting you to Select function.

Sensor controls





The sensor controls react to touch. Every touch of a sensor is confirmed with an audible keypad tone. You can turn this keypad tone off using Further  | Settings | Volume | Keypad tone.

If you want the sensor controls to respond even when the steam oven is switched off, select the Display | Quick-Touch | On setting.



Sensor controls above the display

For information on the functions and operating modes, see “Main and sub-menus”, “Settings”, “Automatic programmes” and “Further applications”.

Sensor controls under the display





Sensor control	Function
	<p>If you want to control the steam oven from your mobile device, you must have the Miele@home system, switch on the Remote control setting and touch this sensor control. The sensor control then lights up orange and the MobileStart function is available.</p> <p>As long as this sensor control is lit, you can control the steam oven via your mobile device (see “Settings – Miele@home”).</p>
	<p>Use this sensor control to start the Quick MW function. The cooking programme runs with the maximum power level (1000 W) and a cooking duration of 1 minute (see “Quick MW”). Touching the sensor control repeatedly increases the cooking duration in set stages.</p> <p>This function can only be used when no other cooking programmes are in use.</p>
	<p>Depending on which menu you are in, this sensor control will take you back a level or back to the main menu.</p> <p>If a cooking programme is in progress at the same time, use this sensor control to change values and settings such as the temperature or cooking duration for the programme, or to cancel the programme.</p>
	<p>In the navigation area, use the arrow buttons or the area between them to scroll up or down in the selection lists. The menu options will be highlighted one after the other as you scroll through them. The desired menu option must be highlighted before you can select it.</p> <p>You can change the values or settings that are highlighted by using the arrow buttons or the area between them.</p>

Controls

Sensor control	Function
OK	<p>Functions highlighted in the display can be selected by touching the OK sensor control. The selected function can then be changed.</p> <p>Confirm with OK to save changes.</p> <p>If information appears in the display, select OK to confirm the message.</p>
	<p>If no cooking programme is in progress, you can use this sensor control to set a minute minder (e.g. when boiling eggs) at any point.</p> <p>If a cooking programme is in progress at the same time, you can set a minute minder, the cooking duration and a start or end time for the programme.</p>
	<p>Select this sensor control to switch the oven interior lighting on and off.</p> <p>Depending on the setting selected, the oven interior lighting switches off after 15 seconds or remains constantly switched on or off.</p>

Symbols

The following symbols may appear in the display:

Symbol	Meaning
	This symbol indicates that there is additional information and advice about using the appliance. Press the OK sensor control to confirm the information.
	Minute minder
	A tick indicates the option which is currently selected.
	Some settings, e.g. display brightness and buzzer volume are selected using a bar chart.
	The system lock prevents the steam oven being switched on by mistake (see “Settings – Safety”).

Use the \wedge and \vee arrow buttons or the **|||||** area between them in the navigation area to use the steam oven.

As soon as you reach a value, message or setting you need to confirm, the *OK* sensor control will light up orange.

Selecting a menu option

- Touch the \wedge or \vee arrow buttons or swipe to the right or left in the **|||||** area until the desired menu option is highlighted.

Tip: If you press and hold the arrow button, the list continues scrolling automatically until you release the arrow button.

- Confirm your selection with *OK*.

Changing a setting in a list

- Touch the \wedge or \vee arrow buttons or swipe to the right or left in the **|||||** area until you reach the desired value or the desired setting is highlighted.

Tip: A \checkmark tick will appear beside the current setting.

- Confirm with *OK*.

The setting is now saved. This will take you back to the previous menu.

Changing the setting with a segment bar

Some settings are represented by a bar **■■■■■□□□** with seven segments. If all of the segments are illuminated, the maximum value is selected.

If none of the segments are illuminated, or only one of them is, the minimum value is selected or the setting is switched off altogether (e.g. volume).

- Touch the \wedge or \vee arrow buttons or swipe to the right or left in the **|||||** area until you reach the desired setting.

- Confirm your selection with *OK*.

The setting is now saved. This will take you back to the previous menu.

Using the appliance

Selecting a function or operating mode

The sensor controls for the functions and operating modes (e.g. Further ) are located above the display (see “Controls” and “Settings”).

- Touch the sensor control for the desired function.

The sensor control on the fascia panel lights up orange.

- Under Further , scroll through the lists until the desired menu option is highlighted.
- Set the values for the cooking programme.
- Confirm with *OK*.

Changing the function

You can change to another function during a cooking programme.

The sensor control for the previously selected function lights up orange.

- Touch the sensor control of the new function or operating mode.

The new function appears in the display with its corresponding recommended values.

The sensor control for the new function lights up orange.

Under Further , scroll through the lists until you reach the desired menu option.

Entering numbers

Numbers that can be changed are highlighted.

- Touch the \wedge or \vee arrow buttons or swipe to the right or left in the **|||||** area until the desired number is highlighted.

Tip: If you press and hold an arrow button, the numbers continue scrolling automatically until you release the arrow button.

- Confirm with *OK*.

The changed number is now saved. This will take you back to the previous menu.

Entering letters

Letters are entered via the navigation area. It is best to select short names.

- Touch the \wedge or \vee arrow buttons or swipe to the right or left in the **|||||** area until the desired character is highlighted.

The character you have selected will appear in the top line of the display.

Tip: A maximum of 10 characters can be used.

You can delete the characters one at a time with \leftarrow .

- Select the rest of the characters.
- Once you have entered the name, select \checkmark .
- Confirm with *OK*.

The name is now saved.

Activating MobileStart

- Select the  sensor control to activate MobileStart.

The  sensor control lights up. You can operate your steam oven remotely with the Miele@mobile app.

Directly operating the steam oven takes priority over operating it via the remote control function on the app.

You can use MobileStart as long as the  sensor control is lit up.

Description of functions

Steam cooking mode

Water container

The maximum filling volume is 1.5 litres and the minimum is 0.5 litres. There are markings on the water container. The upper marking must never be exceeded.

Water consumption depends on the type of food and the duration of cooking. The water may need to be topped up during cooking. Water consumption is increased if the door is opened during cooking.

The water container is removed using a push/pull system: push gently on the water container to remove it.

At the end of a cooking programme, hot water left in the steam generator is pumped back into the water container. The water container must be emptied after each use involving steam.

Temperature

Some functions have a pre-set recommended temperature. This temperature can be altered for a single programme, a specific programme stage or within the given range for a programme. You can alter the recommended temperature in 5 °C increments, or 1 °C increments in sous-vide cooking (see “Settings – Recommended temperatures”).

Cooking duration

You can set the cooking duration from 1 minute (00:01) to 10 hours (10:00). If the cooking duration exceeds 59 minutes you have to enter it in hours and minutes. Example: Cooking duration 80 minutes = 1:20.

During steam cooking, the cooking duration does not begin until the set temperature is reached.

Noises

You will hear a pumping sound when the appliance is switched on, during use and after switching it off. This is the sound of water being pumped through the system and is quite normal.

When the steam oven is in use, you will hear a fan noise.

Heating-up phase

While the steam oven is being heated up to the set temperature, the display will show **Heating-up** and the rising oven compartment temperature.

When cooking with steam, the duration of the heating-up phase will depend on the quantity and the temperature of the food. In general the heating-up phase will last for approx. 7 minutes. The duration will be longer if you are cooking refrigerated or frozen food. The heating-up phase may also last longer if cooking temperatures are low or if you are using the **Sous-vide**  cooking function.

Cooking phase

The cooking phase begins when the set temperature is reached. During the cooking phase, the duration remaining will be shown in the display.

Steam reduction

If you are cooking at a temperature of approx. 80 °C or above, the steam oven door will automatically open a little shortly before the end of the cooking time to allow some of the steam to escape. **Steam reduction** will appear on the display. The door closes again automatically.

Steam reduction can be switched off (see “Settings – Steam reduction”). With steam reduction switched off, a lot of steam will escape when the door is opened.

Description of functions

Microwave power

How it works

The steam oven contains a magnetron that converts electrical energy into electromagnetic waves (microwaves). These microwaves are distributed evenly throughout the oven compartment, and are reflected off the metal appliance walls.

The microwaves penetrate inside the food from all sides. Food consists of many molecules. When subjected to microwave energy, these molecules (particularly the water molecules) start to oscillate. This heats the food from the outside to the inside. The more water a food contains, the faster it is reheated or cooked.

Advantages of the microwave oven

- Food can generally be cooked without having to add any/very much extra liquid or fat.
- The times for defrosting, reheating or cooking are shorter than with a hob or oven.



Selecting crockery

In order for microwaves to reach the food, they must be able to penetrate the crockery being used. Microwaves can pass through porcelain, glass, cardboard and plastics, but not metal. Therefore, do not use metal containers or crockery that contains metal. Metal reflects the microwaves which can create sparks and the microwaves are not absorbed by the metal.

 Risk of injury from increased pressure in sealed containers or bottles.

Pressure can build up during reheating in sealed containers or bottles, causing them to explode.

Never cook or reheat solid or liquid food in sealed containers or bottles. Open containers beforehand. In the case of baby bottles, the screw top and teat must be removed.

 Fire hazard due to using unsuitable crockery with the Microwave  function.

Non-microwave safe dishes can sustain damage or damage the steam oven.

Only use microwave-safe crockery with the Microwave  function.

The material and shape of the crockery used affect the reheating and cooking durations.

Heat distribution is more even in round and oval-shaped shallow containers. Food is reheated more evenly in these containers than in square containers.

Suitable crockery

 Fire hazard due to inflammable materials.

Disposable containers made out of plastic, paper or other inflammable materials can ignite, causing damage to the steam oven.

Do not leave the steam oven unattended when reheating or cooking food in disposable containers made of plastic, paper or other inflammable materials.

You can use the following crockery and material:

- Heat-resistant glass and ceramic glass
Exception: crystal glass as it contains lead and may crack.
- Porcelain
 - Without metallic decoration
Metallic decoration (e.g. gold rims or cobalt blue) can cause sparking.
 - Without hollow knobs and handles
Moisture can gather in the hollow knobs and handles. When the moisture evaporates, pressure can build up and the item can explode.
- Unpainted stoneware and stoneware with underglaze paints

 Risk of injury caused by hot crockery.

Stoneware can get hot.

Wear oven gloves when using stoneware.

- Plastic containers and plastic disposable containers with the Microwave  function

Tip: To protect the environment, avoid the use of disposable containers.

Plastic dishes and bags that are not heat-resistant may deform and fuse with the food inside.

Only use plastic containers or bags that are heat-resistant. The plastic containers and bags must be able to withstand temperatures of at least 110 °C.

- Microwave-safe plastic containers
Special plastic containers designed for use in microwave ovens are available from retail outlets.
- Styrofoam containers
For briefly heating food
- Plastic boiling bags
For cooking and reheating. They should be pierced beforehand. The holes allow the steam can escape. This prevents a build-up of pressure from forming and the bag from bursting.
There are also special bags available for steam cooking which do not need to be pierced. Please follow instructions given on the packet.
- Roasting bags and tubes
Please follow the manufacturer's instructions.

 Fire hazard due to metal parts.

Metal parts such as metal clips or plastic and paper ties that have wire running through them can heat inflammable materials until they burn.

Do not use metal clips, or plastic and paper ties containing wire.

Description of functions

- The **rack** and **cooking containers** supplied are **only** suitable for cooking with the Rapid steam cooking  function and with functions that do not use microwave power.
- Aluminium foil trays without lids for defrosting and reheating ready meals. The food is only heated from the top. If you remove the food from the aluminium foil container and transfer it to crockery suitable for use in a microwave oven, the heat distribution will generally be more even.

Using aluminium foil trays and aluminium foil can cause crackling and sparks.

Place aluminium foil trays on the glass tray.

Aluminium foil and aluminium foil trays must not touch the oven compartment walls and must remain at least 2 cm from the walls at all times.



- Metal meat skewers or clamps. The size of the cut of meat must be much larger than the metal skewers and clamps.

Unsuitable crockery

Crockery and lids with hollow handles or knobs can collect moisture in the hollow spaces. When the moisture evaporates, pressure can build up and the item can explode. If the hollow recess is sufficiently ventilated, the item can be used.

Do not use crockery with hollow knobs or handles for cooking.

Do **not** use the following crockery and material:

- Metal racks (including the supplied rack) are **not** suitable for use with the Microwave  function.
- Containers made from metal and stainless steel (including the cooking containers supplied) are **not** suitable for use with the Microwave  function.
- Aluminium foil. Exception: for even defrosting, reheating or cooking unevenly shaped cuts of meat, e.g. poultry, small pieces of aluminium foil may be used to cover thin parts for the last few minutes of the programme.
- Metal clips, plastic or paper ties containing wire
- Plastic containers where the aluminium lid has not been completely removed

Description of functions

- Crystal glass
- Cutlery and crockery with metallic decoration (e.g. gold rims, cobalt blue)
- Crockery with hollow handles
- Plasticware made of melamine
Melamine absorbs microwave energy and gets hot.
When purchasing plasticware, make sure that it is suitable for use in a microwave oven.
- Non-heat-resistant plastic containers and bags
- Wooden dishes
Water contained in wood evaporates during the cooking programme. This causes the wood to dry and crack.

Placing the dish in the oven compartment

- Place the glass tray on shelf level 1.
- The dish containing the food should be placed in the middle of the glass tray.

Placing the food directly on the floor of the oven would give unsatisfactory and uneven results as the microwaves would not be able to reach the food from below.

Description of functions

Cover

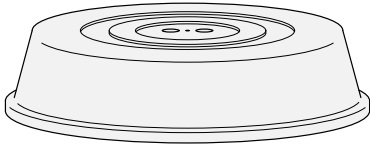

Tip: Covers are available from retail outlets.

- A cover prevents too much steam escaping, especially when reheating foods over a longer period of time.
 - It speeds up the heating process of the food.
 - It prevents food from drying out.
 - It keeps the oven compartment clean.
- Use a glass or plastic cover suitable for microwave use for cooking programmes with the Microwave  function.

Alternatively, use a cling film suitable for use in a microwave oven. Heat can cause normal cling film to distort and fuse with the food.

The cover should not form a seal with the container. If the container has a narrow diameter, the steam may not be able to escape. The cover could get too hot and start to melt.

Use containers with a sufficiently large diameter.

- Do **not** use a cover for reheating the following types of food:
- Food coated in breadcrumbs
 - Food that needs to be heated or cooked using the Rapid steam cooking  function.

Glass tray

Functions/applications involving steam:
When using perforated containers, place the glass tray on shelf level 1. This collects any drops of liquid and allows it to be removed easily.

The condensate cannot evaporate properly if the glass tray is on the floor of the steam oven.

Place the glass tray on shelf level 1.

Microwave  function:

Always use the glass tray as a surface to place containers on in shelf level 1.

Oven interior lighting

For energy saving reasons, the oven compartment lighting has been set at the factory to go out after the programme has begun.

If you want it to stay on all the time the oven is on you will need to alter the default setting (see “Settings - Lighting”).

If the door is left open at the end of a cooking programme the oven lighting will switch off automatically after 5 minutes.

The lighting can be switched on for 15 seconds by pressing the  button on the control panel.

Before using for the first time

Miele@home

Your steam oven is equipped with an integrated WiFi module.

In order to use it, you will need:

- a WiFi network,
- the Miele@mobile app, and
- a Miele user account, which can be created from the Miele@mobile app.

The Miele@mobile app will guide you as you connect your steam oven to your home WiFi network.

Once your steam oven is connected to your WiFi network, you can use the app for a number of actions, including the following:

- Getting information on the operating status of your steam oven
- Retrieving information on your steam oven's current cooking programmes
- Stopping cooking programmes that are in progress

Connecting your steam oven to your WiFi network will increase energy consumption, even when the steam oven is switched off.

Make sure that the signal of your WiFi network is sufficiently strong in the place where your steam oven is installed.

Availability of the WiFi connection

The WiFi connection shares a frequency range with other appliances (including microwave ovens and remote control toys). This can give rise to sporadic or even complete connection failures. Therefore, the availability of featured functions cannot be guaranteed.

Miele@home availability

The ability to use the Miele@mobile app depends on the availability of the Miele@home service in your country.

The Miele@home service is not available in every country.

For information about availability, please visit www.miele.com.

Miele@mobile App

The Miele@mobile App is available to download free of charge from the Apple App Store® or from the Google Play Store™.



Basic settings

The following settings must be made before starting up for the first time. You can change these settings again at a later time (see “Settings”).

 Risk of injury caused by hot surfaces.

The steam oven gets hot during operation.

For safety reasons, the steam oven may only be used when it has been fully installed.

The steam oven will switch on automatically when it is connected to the electricity supply.

Setting the language

- Select the desired language.
- Confirm with *OK*.

If you have selected the wrong language by mistake, proceed as described in “Settings –  Language”.

Setting the location

- Select the desired location.
- Confirm with *OK*.

Setting up Miele@home

Set up “Miele@home” will appear in the display.

- To set up Miele@home now, select *Continue* and confirm with *OK*.
- To set it up at a later date, select *Skip* and confirm with *OK*. See “Settings – Miele@home” for information on setting up at a later date.
- To set up Miele@home now, select the desired connection method.

You will then be guided by the display and the Miele@mobile app.

Setting the date

- Set the year, then the month, and finally the day.
- Confirm with *OK*.

Setting the time

- Set the time of day in hours and minutes.
- Confirm with *OK*.

Before using for the first time

Setting the water hardness level

Contact your local water supplier to find out the hardness of the water in your area.

More information can be found under “Settings – Water hardness”.

- Select your local water hardness on the appliance.
- Confirm with *OK*.

Completing the commissioning process

- Follow any further instructions in the display.

The oven is now ready for use.

Cleaning for the first time

- Remove any protective wrapping and stickers from the steam oven and accessories.

The appliance has undergone a function test in the factory. Residual water from this testing may have trickled back into the cabinet during transportation.

Cleaning the water container

- Remove the water container.
- Remove the spill guard.
- Wash the water container by hand.

Cleaning accessories/oven compartment

- Take all accessories out of the oven.
- Wash the accessories in a mild solution of washing-up liquid and hot water or in the dishwasher.

The interior of the steam oven has been treated at the factory with a conditioning agent.

- To remove this, clean the oven compartment with a clean sponge and a mild solution of washing-up liquid and hot water.

Set the correct boiling point for water

Before cooking food for the first time, you must adjust the steam oven to the boiling temperature of the water, which varies depending on the altitude of where the steam oven is located. This process also flushes out the components of the appliance that carry water.

This procedure **must** be carried out to ensure trouble-free functioning of your appliance.

Distilled water, carbonated water and other liquids may damage the steam oven.

Only use cold, fresh tap water (below 20 °C).





- Remove the water container and fill it up to the maximum marker.
- Push the water container into the appliance.
- Then run the steam oven for 15 minutes using the Steam cooking  function (100 °C). Proceed as described in “Operation”.

Setting the correct boiling point for water following a house move

If you move house, the appliance will need to be re-set for the new altitude if this differs from the old one by 300 m or more. To do this, descale the appliance (see “Cleaning and care – Descaling the steam oven”).

Settings

Settings overview

Menu option	Available settings
Language 	... deutsch english ... Location
Time	Show On* Off Night dimming Clock format 12 h 24 h* Set
Date	
Lighting	On "On" for 15 seconds* Off
Display	Brightness  QuickTouch On Off*
Volume	Buzzer tones Melodies*  Solo tone  Keypad tone  Welcome melody On* Off
Units	Weight g* lb/oz lb Temperature °C* °F
Quick MW	Power level Duration
Popcorn	Duration
Keeping warm	Steam cooking On Off* Microwave On Off*
Steam reduction	On* Off



* Factory default setting

Menu option	Available settings
Recommended temperatures	
Recommended power levels	
Water hardness	1 °dH ... 15 °dH* ... 70 °dH
Safety	Sensor lock On Off* System lock  On Off*
Miele@home	Activate Deactivate Connection status Set up again Reset Set up
Remote control	On* Off
RemoteUpdate	On* Off
Software version	
Showroom programme	Demo mode On Off*
Factory default	Appliance settings User programmes Recommended power levels Recommended temperatures

* Factory default setting

Settings

Opening the “Settings” menu

In the Further  | Settings  menu, you can personalise your steam oven by adapting the factory default settings to suit your requirements.

- Select Further .
- Select Settings .
- Select the desired setting.



You can check settings or change them.

Settings cannot be changed while a cooking programme is in progress.

Language

You can set the desired language and location.

After selecting and confirming your choice, the language you have selected will appear in the display.

Tip: If you have selected the wrong language by mistake, select the  sensor control. Follow the  symbol to get back to the Language  sub-menu.

Time

Show

Select how you want the time of day to show in the display when the steam oven is switched off:

- On
The time is always visible on the display.
If you also select the Display | Quick-Touch | On setting, all sensor controls react to touch straight away.
If you also select the Display | Quick-Touch | Off setting, the steam oven has to be switched on before it can be used.
- Off
To save energy, the display does not light up. The steam oven has to be switched on before it can be used.
- Night dimming
To save energy the time only shows in the display between 05:00 and 23:00. The display remains dark at all other times.

Clock format

The time of day can be displayed in the 24 or 12-hour format (24 h or 12 h).

Set

Set the hours and the minutes.



If there is a power cut, the current time of day will reappear once power has been restored. The time of day is saved for approx. 150 hours.

If the steam oven has been connected to a WiFi network and signed into the Miele@mobile app, the time will be synchronised based on the location setting in the Miele@mobile app.

Date

Set the date.

Lighting

- On
The oven interior lighting is switched on during the entire cooking period.
- "On" for 15 seconds
The oven interior lighting switches off 15 seconds after a cooking programme has begun. Press the  sensor control to switch the oven interior lighting on again for 15 seconds.
- Off
The oven interior lighting is switched off. Press the  sensor control to switch on the oven interior lighting for 15 seconds.

Display

Brightness

The display brightness is represented by a bar with seven segments.

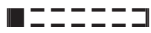
- 
Maximum brightness
- 
Minimum brightness

QuickTouch

Select how the sensor controls should respond when the steam oven is switched off:

- On
If you have also selected the Time | Show | On or Night dimming setting, the sensor controls will also respond when the steam oven is switched off.
- Off
Independently of the Time | Show setting, the sensor controls only respond when the steam oven is switched on, as well as for a certain amount of time after switching it off.

Settings

Volume

Buzzer tones

If buzzers are switched on, a buzzer will sound when the set temperature is reached and at the end of a set time.

Melodies

At the end of a process, a melody will sound several times in intervals.

The volume of the melody is represented by a bar with seven segments.

- 
Maximum volume

- 
Melody is switched off

Solo tone

At the end of a process, a continuous tone will sound for a period of time.

The pitch of this continuous tone is represented by a segment bar.

- 
Maximum pitch

- 
Minimum pitch

Keypad tone

The volume of the tone that sounds each time you touch a sensor control is represented by a bar with seven segments.

- 
Maximum volume

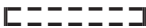
- 
Tone is switched off

Welcome melody

The melody that sounds when you touch the  On/Off sensor control can be switched on or off.

Units

Weight

For automatic programmes, you can set the weight of food in grams (g), pounds/ounces (lb/oz) or pounds (lb).

Temperature

You can set the temperature in degrees Celsius (°C) or degrees Fahrenheit (°F).

Quick MW

The maximum microwave power level of 1000 W and the maximum cooking duration of 1 minute are pre-set for starting the microwave oven immediately.

- Power level
The following microwave power levels can be selected: 80 W, 150 W, 300 W, 450 W, 600 W, 850 W or 1000 W.
- Duration
The maximum cooking duration that can be set depends on the microwave power level selected:
80–300 W: maximum 10 minutes
450–1000 W: maximum 5 minutes

Popcorn

A microwave power level of 850 W and a cooking duration of 2:50 minutes is pre-set so that you can start cooking a bag of microwave popcorn immediately. These settings match the manufacturer's instructions on most bags of microwave popcorn.

The maximum cooking duration that can be set is 4 minutes.

The microwave power level is set and cannot be modified.

Keeping warm function

Using the Keeping warm function you can keep food warm after cooking. Food is kept warm at a pre-set temperature or microwave power for a maximum of 15 minutes. You can cancel the keeping warm process by opening the door or touching the sensor controls.

Please note that delicate food, especially fish, can continue cooking whilst being kept warm.

Steam cooking

- On
The Keeping warm function is switched on. When cooking with a temperature of approx. 80 °C or above, this function is active after approx. 5 minutes. The food is kept warm at a temperature of 70 °C.
- Off
The Keeping warm function is switched off.

Microwave

- On
The Keeping warm function is switched on. When cooking with a microwave power of at least 450 W and over a cooking duration of at least 10 minutes, this function is active after approx. 5 minutes. The food is kept warm with a microwave power of 150 W.
- Off
The Keeping warm function is switched off.

Settings

Steam reduction

- On
If you are cooking at a temperature of approx. 80 °C or above, the steam oven door will automatically open a little shortly before the end of the cooking duration. The function stops excessive steam escaping when the door is opened. The door closes again automatically.
- Off
If steam reduction is switched off, the Keeping warm function is also automatically switched off. With steam reduction switched off, a lot of steam will escape when the door is opened.

Recommended temperatures

If you often cook with different temperatures, it makes sense to change the recommended temperatures.

After selecting this menu option, a list of functions will appear in the display.



- Select the desired function.

The recommended temperatures are displayed along with the available temperature range.



- Change the recommended temperatures.
- Confirm with *OK*.

Recommended power levels

If you often cook with different power levels, it makes sense to change the recommended microwave power levels.

You can change the recommended power levels for the Microwave  function and for the Rapid steam cooking  function combining steam cooking and microwave cooking.

After selecting this menu option, a list of functions will appear in the display together with their recommended power levels.

- Microwave :
80 W, 150 W, 300 W, 450 W, 600 W, 850 W, 1000 W
- Rapid steam cooking :
80 W, 150 W, 300 W

- Select the desired function.
- Change the recommended power level.
- Confirm with *OK*.

Water hardness

The steam oven must be adjusted to the local water hardness level to ensure that it works correctly and to ensure that descaling is carried out at the correct interval. The harder the water is, the more frequently the steam oven needs to be descaled.

Contact your local water supplier to find out the hardness of the water in your area.

If you use bottled water, such as mineral water, make sure it is not carbonated. Adjust this setting depending on the calcium content. The calcium content is specified on the label of the bottle in mg/l Ca²⁺ or ppm (mg Ca²⁺/l).

You can set the hardness level between 1 °dH and 70 °dH. The hardness level is set to 15 °dH by default.

- Select your local water hardness on the appliance.
- Confirm with OK.

Water hardness		Calcium content mg/l Ca ²⁺ or ppm (mg Ca ²⁺ /l)	Setting
°dH	mmol/l		
1	0.2	7	1
2	0.4	14	2
3	0.5	21	3
4	0.7	29	4
5	0.9	36	5
6	1.1	43	6
7	1.3	50	7
8	1.4	57	8
9	1.6	64	9
10	1.9	71	10

Water hardness		Calcium content mg/l Ca ²⁺ or ppm (mg Ca ²⁺ /l)	Setting
°dH	mmol/l		
11	2.0	79	11
12	2.2	86	12
13	2.3	93	13
14	2.5	100	14
15	2.7	107	15
16	2.9	114	16
17	3.1	121	17
18	3.2	129	18
19	3.4	136	19
20	3.6	143	20
21	3.8	150	21
22	4.0	157	22
23	4.1	164	23
24	4.3	171	24
25	4.5	179	25
26	4.7	186	26
27	4.9	193	27
28	5.0	200	28
29	5.2	207	29
30	5.4	214	30
31	5.6	221	31
32	5.8	229	32
33	5.9	236	33
34	6.1	243	34
35	6.3	250	35
36	6.5	257	36
37–45	6.6–8.0	258–321	37–45
46–60	8.2–10.7	322–429	46–60
61–70	10.9–12.5	430–500	61–70

Settings

Safety

Sensor lock

The sensor lock prevents the cooking programme being switched off by mistake or settings being changed. Apart from the  On/Off sensor control, the activated sensor lock prevents the sensor controls and fields in the display from working a few seconds after a programme has been started.

- On
The sensor lock is activated. Touch the *OK* sensor control for at least 6 seconds to deactivate the sensor lock for a short period of time.
- Off
The sensor lock is deactivated. All sensor controls react to touch as normal.

System lock

The system lock prevents the steam oven being switched on by mistake.

The minute minder and the MobileStart function can still be used when the system lock is active.

The system lock will remain activated even after a mains outage.

- On
The system lock has been activated. Before you can use the steam oven, touch the *OK* sensor control for at least 6 seconds.
- Off
The system lock is deactivated. You can use the steam oven as normal.

Miele@home

The steam oven is a Miele@home-compatible appliance. Your steam oven is fitted ex-works with a WiFi communication module and is suitable for wireless communication.

There are a number of ways of connecting your steam oven to your WiFi network. We recommend connecting your steam oven to your WiFi network using the Miele@mobile App or via WPS.

- Activate
This setting is only visible if Miele@home is deactivated. The WiFi function is reactivated.
- Deactivate
This setting is only visible if Miele@home is activated. Miele@home remains set up, the WiFi function is switched off.
- Connection status
This setting is only visible if Miele@home is activated. The display shows information such as the WiFi reception quality, network name and IP address.
- Set up again
This setting is only visible if a WiFi network has already been set up. Reset the network settings and immediately set up a new network connection.
- Reset
This setting is only visible if a WiFi network has already been set up. The WiFi function is deactivated and the WiFi connection will be reset to the factory default. You must set up a new WiFi connection to be able to use Miele@home.
The network settings should be reset whenever a steam oven is being disposed of or sold, or if a used steam oven is being put into operation. This is the only way to ensure that all personal data has been removed and the previous owner will no longer be able to access the steam oven.
- Set up
This setting is only visible if no WiFi connection has been set up yet. You must set up a new WiFi connection to be able to use Miele@home.

Settings

Remote control

If you have installed the Miele@mobile app on your mobile device, have access to the Miele@home system and have activated the remote control function (On), you can use the MobileStart function and for example retrieve information about steam oven cooking processes that are in progress or end a process that is in progress.

The steam oven requires max. 2 W when operating in networked standby.

Activating MobileStart

- Select the  sensor control to activate MobileStart.

The  sensor control lights up. You can operate your steam oven remotely with the Miele@mobile app.

Directly operating the steam oven takes priority over operating it via the remote control function on the app.

You can use MobileStart as long as the  sensor control is lit up.

RemoteUpdate

The RemoteUpdate menu option is only displayed and can only be selected if the requirements for using Miele@home have been met (see “Before using for the first time – Miele@home”).

The RemoteUpdate function is used for updating the software in your steam oven. If an update is available for your steam oven, it will automatically download it. Updates will not be installed automatically. They must be initiated manually.

If you do not install an update, you can continue to use your steam oven as usual. However, Miele recommends installing updates.

Activating/deactivating

The RemoteUpdate function is activated as standard. Available updates will be downloaded automatically but will only be installed if you initiate installation manually.

Deactivate RemoteUpdate if you do not want any updates to be downloaded automatically.

Running RemoteUpdate

Information about the content and scope of an update will be provided in the Miele@mobile app.

A message will appear in your steam oven display if a software update is available.

You can install the update immediately or postpone this until later. When the steam oven is switched on again, you will be reminded about the update.

Deactivate RemoteUpdate if you do not want to install the update.

The update may take several minutes.

Please note the following information about the RemoteUpdate function:

- You will only receive a message when an update is available.
- Once an update has been installed, it cannot be undone.
- Do not switch the steam oven off during the update. Otherwise, the update will be aborted and will not be installed.
- Some software updates can only be carried out by the Miele Customer Service Department.

Software version

The software version is intended for the Miele Customer Service Department. You do not need this information for domestic use.

Showroom programme

This function enables the steam oven to be demonstrated in showrooms without heating up. This setting is not needed for domestic use.

Demo mode

If you have demo mode activated, Demo mode is activated. The appliance will not heat up will appear when you switch the steam oven on.

- On
Touch the *OK* sensor control for at least 4 seconds to activate demo mode.
- Off
Touch the *OK* sensor control for at least 4 seconds to deactivate demo mode. You can then use the steam oven as normal.

Settings

Factory default

- Appliance settings
Any settings that have been altered will be reset to the factory default settings.
- User programmes
All User programmes will be deleted.
- Recommended power levels
Microwave power levels which have been changed will be reset to the factory default settings.
- Recommended temperatures
Any recommended temperatures that have been changed will be reset to the factory default settings.

Using the Minute minder function

The  minute minder can be used to time other activities in the kitchen, e.g. boiling eggs.

The minute minder can also be used at the same time as a cooking programme for which the cooking duration start and finish times have been set (e.g. as a reminder to stir the food or add seasoning, etc.).

- The maximum minute minder time that can be set is 59 minutes and 59 seconds.

Setting the minute minder

If you have selected the Display | Quick-Touch | Off setting, you will need to switch the steam oven on before setting the minute minder. The minute minder can then be seen counting down in the display when the steam oven is switched off.

Example: you want to boil some eggs and set a minute minder duration of 6 minutes and 20 seconds.

- Select the  sensor control.
- Select Minute minder if a cooking programme is in progress at the same time.

The prompt Set 00:00 min appears.

- Using the navigation area, set 06:20.
- Confirm with OK.

The minute minder duration is now saved.

When the steam oven is switched off the minute minder duration counts down in the display and  appears instead of the time of day.

If you are cooking at the same time,  and the minute minder duration will appear at the bottom of the display.

If you are in a menu, the minute minder counts down in the background.

At the end of the minute minder duration,  will flash, the time will start counting up and a tone will sound.

- Select the  sensor control.
- If required, confirm with OK.

The buzzer will stop and the symbols in the display will go out.

Changing the minute minder duration

- Select the  sensor control.
- Select Minute minder if a cooking programme is in progress at the same time.
- Select Change.
- Confirm with OK.

The minute minder duration selected appears.

- Change the duration set for the minute minder.
- Confirm with OK.

The altered minute minder duration is now saved.











Minute minder

Deleting the minute minder duration



- Select the 🕒 sensor control.
- Select Minute minder if a cooking programme is in progress at the same time.
- Select Delete.
- Confirm with *OK*.

The minute minder duration is now deleted.

Main and sub-menus

Menu	Recommended value	Range
Oven functions		
Steam cooking 	100 °C	40–100 °C
Microwave 	1000 W	80–1000 W
Rapid steam cooking 	300 W 100 °C	80–300 W 80–100 °C
Sous-vide 	65 °C	45–90 °C
User programmes 		
Reheat 		
Steam cooking	100 °C	80–100 °C
Microwave	450 W	450–1000 W
Defrost 		
Steam cooking	60 °C	50–60 °C
Microwave	150 W	80–150 W
Popcorn 		
Automatic programmes 		
Further 		
Blanching	–	–
Bottling	90 °C	80–100 °C
Disinfect items	–	–
Prove dough	–	–
Eco Steam cooking	100 °C	40–100 °C

Main and sub-menus

Menu	Recommended value	Range
Further 		
Maintenance		
Descalc		
Soak		
Settings 		

- Switch the steam oven on.

The main menu will appear.

- If you want to cook using a steam function, fill the water container and fit it back in place.

Distilled water, carbonated water and other liquids may damage the steam oven.

Only use cold, fresh tap water (below 20 °C).

- Place the food in the oven compartment.
- Select the desired function.

The function will appear in the display. Based on the function you have chosen, the recommended power level, recommended temperature and the cooking duration will appear one after the other on the display.

- Change the recommended values for the cooking programme and set the cooking duration if required.

Using the ↵ sensor control, you can change the recommended values later if needed.

- Confirm each entry with *OK*. Confirming the temperature starts the cooking process for functions which **do not use** microwave power.

For functions **which use** microwave power, a summary of the settings appears and *Start* is highlighted in the display.

- Use the *OK* sensor control to start the cooking process for functions **which use** microwave power.

The set values appear and the cooking duration counts down in the display for all functions.

If you have set a temperature, you will see the temperature increasing. A buzzer will sound when the set temperature is reached for the first time.

The oven stops generating microwave power when you interrupt the cooking programme or open the door. You can continue the programme with the *OK* sensor control.

- After cooking, select the sensor control for the selected function to end the cooking programme.

 Risk of injury caused by hot steam.

When using a cooking programme involving steam, a lot of hot steam can escape if the door is opened, which may lead to burns.

Step back and wait until the hot steam has dissipated.

- Take the food out of the oven compartment.
- Switch the steam oven off.

Operation

Cleaning the steam oven

 Risk of injury caused by hot water.

At the end of a steam cooking programme, hot water left in the steam generator is pumped back into the water container.

Take care not to tip the water container when taking it out of the appliance.

- Remove the water container as required.
- Remove the spill guard and empty the water container.
- After each use, clean and dry the whole steam oven as described in “Cleaning and care”.

Make sure the spill guard engages correctly when installing it.

- Leave the appliance door open until the oven compartment is completely dry.

Refilling the water

If water needs replenishing during the programme, a tone will sound and the display will prompt you to refill the container with fresh water.

- Take out the water container and replenish the water.
- Push the water container into the appliance.

The cooking programme is resumed.

Changing values and settings for a cooking programme

Depending on the function, as soon as a cooking programme is in progress, you can use the  sensor control to change the values or settings for this programme.

- Select the  sensor control.

Depending on the function, the following settings appear:



- Temperature
- Power level
- Duration

Changing values and settings

- Select the desired value or setting and confirm with *OK*.
- Change the value or setting and confirm with *OK*.

The cooking programme will restart with the new values and settings.



Changing the temperature



You can permanently reset the recommended temperature to suit your cooking preferences by selecting Further  | Settings  | Recommended temperatures.

- Select the  sensor control.
- Select Temperature and confirm with *OK*.
- Change the desired temperature via the navigation area.
- Confirm with *OK*.

The cooking programme will restart with the new desired temperature.

Changing the microwave power level

You can change the microwave power level in the Microwave  and Rapid steam cooking  functions.

Select Further  | Settings  | Recommended power levels to permanently set the recommended power level to suit your personal cooking preferences.

- Select the  sensor control.
- Select Power level and confirm with *OK*.
- Change the microwave power level via the navigation area.

You can set the microwave power level to 80 W, 150 W, 300 W, 450 W, 600 W, 850 W, 1000 W, depending on the function in question.

- Confirm with *OK*.
- Start will be highlighted.
- Select the *OK* sensor control.

The programme will restart with the new microwave power level.

Operation

Setting cooking durations

Cooking results can be impaired if there is a long delay between the food being placed in the oven and the start of cooking. Fresh food can change colour and even spoil. Select as short as possible a time until the cooking programme starts.

You have placed the food in the oven compartment, selected a function and the required settings such as the temperature.

By entering Duration, Finish at or Start at via the ⊕ sensor control, you can automatically switch the cooking programme off or on and off.

- Duration
Enter the desired cooking duration for the food. The heating will switch off automatically once this duration has elapsed. The maximum cooking duration that can be set depends on the function that you have selected.
- Finish at
Specify when you want the cooking programme to end. The oven heating will switch off automatically at the time you have set.
- Start at
This function will only appear in the menu if you have set a Duration or Finish at time. With Start at, you have to specify when you want the cooking programme to start. The oven heating will switch on automatically at the time you have set.

- Select the ⊕ sensor control.
- Set the desired times.
- Confirm with OK.
- Touch the ↵ sensor control to return to the menu of the selected function.

Tip: In functions involving steam, you can also adjust the cooking duration directly using the navigation area.

For cooking programmes involving steam, the cooking duration does not begin until the set temperature is reached.

If you are cooking at a temperature of approx. 80 °C or above, Steam reduction will appear in the display shortly before the end of the cooking duration and the door will automatically open a little.

- Wait until Steam reduction goes out in the display before opening the door and removing the food from the oven compartment.

A new cooking programme can only be started if the automatic door release is retracted into its original position. Do not push it in manually as this could damage it.

Changing the set cooking durations

- Select the ⌚ sensor control.
- Select the desired time.
- Confirm with *OK*.
- Select *Change*.

This menu option does not appear if you want to change the cooking duration for functions **which use** microwave power, as these functions always require a set cooking duration.

The time will be highlighted.

- Change the set time.
- Confirm with *OK*.
- Touch the ↵ sensor control to return to the menu of the selected function.
- Use the *OK* sensor control to continue the cooking programme for functions **which use** microwave power.

These settings will be deleted in the event of a power failure.

Tip: You can also change the cooking duration via the navigation area.

Deleting the set cooking durations

For a function **which uses** microwave power, you can only delete the set times for *Finish at* and *Start at*. The cooking duration must always be set.

- Select the ⌚ sensor control.
- Select the desired time.
- Confirm with *OK*.
- Select *Delete*.
- Confirm with *OK*.
- Touch the ↵ sensor control to return to the menu of the selected function.



If you delete *Duration* for a function which **does not use** microwave power, the set times for *Finish at* and *Start at* are also deleted.

If you delete *Finish at* or *Start at*, the cooking programme will start using the cooking duration set.

Tip: In functions involving steam, you can also clear the cooking duration using the navigation area.

Operation

Interrupting the cooking process for functions which use microwave power

You can interrupt cooking when using the Microwave  and Rapid steam cooking  functions and pause the cooking duration.

During the cooking duration, Stop will be highlighted.

- Select the *OK* sensor control.

Cooking is interrupted and the cooking duration is paused.

Start will be highlighted.

- Select the *OK* sensor control.

The cooking programme resumes and the cooking duration continues to count down.

Interrupting the cooking process for functions involving steam

In functions involving steam, opening the door will interrupt the cooking programme. The oven heating switches off. Set cooking durations will be saved.

 Risk of injury caused by hot steam.

A great deal of hot steam can escape when the door is opened. The steam can cause burns.

Step back and wait until the hot steam has dissipated.

 Risk of injury caused by hot surfaces and food.

The steam oven gets hot during operation. You could burn yourself on the oven compartment, side runners, accessories or the food itself.

Use oven gloves when placing food in the oven or removing it and when working in a hot oven.

When placing cooking containers into the oven or removing them, make sure that the hot food does not spill.

The cooking programme will resume when the door is closed.

When the door is closed, the pressure has to equalise, which can cause a whistling sound.

The steam oven will heat up again and the display will show the temperature in the oven compartment as it rises. Once the set temperature has been reached, the display will show the time left as it counts down.

The cooking programme will finish early if the door is opened in the last minute of cooking.

Cancelling a cooking programme

You can cancel a cooking programme using the function sensor control that lights up orange or using the ↵ sensor control.

The oven compartment heating and lighting will then switch off. Any cooking durations set will be deleted.

Touch the function sensor control to return to the main menu.

Cancelling a cooking programme without a set cooking duration

- Touch the sensor control for the selected function.

The main menu will appear.

- **Or:** select the ↵ sensor control.
- Select *Cancel process*.
- Confirm with *OK*.

Cancelling a cooking programme with a set cooking duration

- Touch the sensor control for the selected function.

Cancel process? appears in the display.

- Select *Yes*.
- Confirm with *OK*.
- **Or:** select the ↵ sensor control.
- Select *Cancel process*.
- Confirm with *OK*.
- Select *Yes*.
- Confirm with *OK*.

Quick MW and Popcorn

These functions can only be used when no other cooking programmes are in use.

Always use the glass tray.

Quick MW

If you select the  sensor control, the microwave oven starts with a set microwave power level and cooking duration, e.g. to reheat a drink.

The maximum microwave power level of 1000 W and a maximum cooking duration of 1 minute are pre-set.

You can change the microwave power level and the cooking duration. The maximum cooking duration that can be set depends on the microwave power level selected (see “Settings – Quick MW”).

- Select the  sensor control. Touching it repeatedly increases the cooking duration in set stages.

The time left will appear in the display.

You can interrupt and restart the cooking programme at any time by touching the *OK* sensor control or cancel it with the  sensor control.

At the end of the cooking programme, *Finished* appears in the display and a buzzer sounds.

- Select the  sensor control.

The main menu will appear.

Popcorn

If you select the  sensor control, the microwave oven starts with a set microwave power level and cooking duration.

A microwave power level of 850 W and a maximum cooking duration of 2:50 minutes are pre-set. These settings match the manufacturer's instructions on most bags of microwave popcorn.

The maximum cooking duration that can be set is 4 minutes. The microwave power level is set and cannot be modified (see "Settings – Popcorn").

Follow the manufacturer's instructions regarding the cooking duration on the packaging. Change the pre-defined time if necessary.

- Select the  sensor control.

The time left will appear in the display.

You can interrupt and resume the cooking programme at any time by touching the *OK* sensor control or cancel it with the  sensor control.

Disposable containers made out of paper or other inflammable materials can ignite, causing damage to the steam oven.

Do not leave the steam oven unattended during the cooking programme and make sure you follow the instructions on the packaging.

At the end of the cooking programme, *Finished* appears on the display and a buzzer sounds.

- Select the  sensor control.

The main menu will appear.

General notes on steam cooking

This section contains general information on steam cooking. You will find more detailed information about particular foods and how to cook them in the other sections.

The advantages of cooking with steam

Almost all vitamins and minerals are retained as the food is not immersed in water.

Cooking with steam also retains the true taste of the food better than conventional cooking. We therefore recommend seasoning the food after it has been cooked. Food also retains its fresh, original colour.

Suitable containers

Cooking containers

This steam oven is supplied with stainless steel cooking containers. Other containers, in a variety of sizes, both perforated and solid, are available as optional extras (see “Optional accessories”). This enables you to choose the most suitable container for the food you are cooking.

It is best to use perforated containers for steam cooking. The steam can reach the food from all sides and the food is cooked evenly.

Your own containers

You can also use your own containers. However, please note the following:

- Containers must be heat-resistant to 100 °C and able to withstand steam. With plastic containers please check with the manufacturer that they are suitable for use in a steam oven.
- Thick-sided containers such as porcelain, ceramic, or stoneware are not very suitable for using with steam. Due to their thick sides, they do not conduct heat well and as a result cooking durations will be considerably longer than those given in the tables.
- Place the cooking container on the rack or in a suitable container, and not on the oven floor.
- Ensure that there is a gap between the upper rim of the container and the top of the cooking compartment to allow sufficient steam into the container.

Glass tray

When using perforated containers, place the glass tray on shelf level 1. This collects any drops of liquid and allows it to be removed easily.

The condensate cannot evaporate properly if the glass tray is on the floor of the steam oven.
Place the glass tray on shelf level 1.

Shelf level

You can select any shelf level for the cooking containers and the rack. You can also cook on several levels at the same time. This will not alter the cooking duration.

When using more than one deep container at the same time for steam cooking it is best to offset them on their runners and to leave at least one level free in between them. If possible, leave one shelf level free between the cooking containers.

Always insert cooking containers, the rack and the glass tray between the rails of the shelf level supports so that they cannot tip.

Frozen food

The heating up phase for frozen food is longer than for fresh food. The greater the quantity of frozen food, the longer the heating up phase.

Temperature

During steam cooking, the temperature does not exceed 100 °C. Almost all foods can be cooked at this temperature. Some types of food, such as berries, need to be cooked at lower temperatures to prevent them from bursting. See the relevant sections in these operating instructions for more details.

Cooking duration

During steam cooking, the cooking duration does not begin until the set temperature is reached.

In general, the cooking durations for cooking with steam are the same as for cooking food in a saucepan. More information about any factors which may affect the cooking duration is given in the relevant sections.

The quantity of food does not affect the cooking duration. 1 kg of potatoes will take the same time to cook as 500 g.

Cooking with liquid

When cooking with liquid only fill the cooking container $\frac{2}{3}$ full to prevent the liquid spilling when the cooking container is removed from the oven.

Your own recipes

Food which is cooked in a pot or a pan can also be cooked in the steam oven. The cooking durations in the steam oven will be the same. Please note that food will not be brown or crisp when cooking with steam.

Steam cooking

Eco Steam cooking

You can use the Eco Steam cooking function to save energy during steam cooking. This function is suitable mainly for cooking fish and vegetables.

We recommend following the cooking durations and temperatures from the tables specified in “Steam cooking”. You can cook for longer if necessary.

When cooking starchy foods such as potatoes, rice and pasta, the best function to use is Steam cooking .

Settings

Further  | Eco Steam cooking

Notes on the cooking tables

Follow the instructions on cooking durations, temperatures and cooking notes.

Selecting the cooking duration

The cooking durations given are guidelines only.

- We recommend selecting the shorter duration initially. You can cook for longer if necessary.

Vegetables

Fresh

Prepare fresh vegetables in the usual way, i.e. wash, clean and cut them up.

Frozen food

Frozen vegetables do not need to be defrosted beforehand, unless they have been frozen together in a block.

Frozen and fresh vegetables which take the same length of time to cook can be cooked together.

If vegetables have frozen together in clumps, break these up before cooking with steam. Follow the manufacturer's instructions on the packaging regarding cooking duration.

Cooking containers

Food such as peas or asparagus spears, which have little or no space between them, will take longer to cook because the steam has less space to work in. For an even result, it is best to use a shallow container for these types of food, and only fill it about 3-5 cm deep. When cooking large quantities divide the food between 2 or 3 shallow containers rather than using one deep one.

Different types of vegetables which take the same length of time to cook can be cooked together.

Use solid containers for vegetables which are cooked in liquid.

Shelf level

To avoid any colour transfer when cooking vegetables with a distinctive colour (e.g. beetroot) in a perforated container, do not place other food underneath the perforated container.

Cooking duration

The cooking duration depends on the size of the food and how well cooked you want it, just as it does with conventional cooking methods. Example:

Waxy potatoes, cut into quarters:
approx. 17 minutes

Waxy potatoes, cut in half:
approx. 20 minutes

Settings

Automatic programmes  | Vegetables
| ... |

or

Steam cooking 

Temperature: 100 °C

Cooking duration: see table

Steam cooking

Vegetables	🕒 [min]
Artichokes	32–38
Cauliflower, whole	27–28
Cauliflower, florets	8
Beans, green	10–12
Broccoli, florets	3–4
Chantenay carrots, whole	7–8
Chantenay carrots, halved	6–7
Chantenay carrots, chopped	4
Chicory, halved	4–5
Chinese cabbage, chopped	3
Peas	3
Fennel, halved	10–12
Fennel, sliced	4–5
Kale, chopped	23–26
Waxy potatoes, peeled whole	27–29
halved	21–22
quartered	16–18
Mainly waxy potatoes, peeled whole	25–27
halved	19–21
quartered	17–18
Floury potatoes, peeled whole	26–28
halved	19–20
quartered	15–16
Kohlrabi, cut into batons	6–7
Pumpkin, diced	2–4
Corn on the cob	30–35
Chard, chopped	2–3

Steam cooking

Vegetables	 [min]
Peppers, diced or sliced	2
New potatoes, firm	30–32
Mushrooms	2
Leeks, sliced	4–5
Leeks, halved lengthways	6
Romanesco, whole	22–25
Romanesco, florets	5–7
Brussels sprouts	10–12
Beetroot, whole	53–57
Red cabbage, chopped	23–26
Black salsify, whole	9–10
Celeriac, cut into batons	6–7
Asparagus, green	7
Asparagus, white, whole	9–10
Carrots, chopped	6
Spinach	1–2
Spring cabbage, chopped	10–11
Celery, chopped	4–5
Swede, chopped	6–7
White cabbage, chopped	12
Savoy cabbage, chopped	10–11
Courgettes, sliced	2–3
Sugar snap peas	5–7

 Cooking duration

Steam cooking

Fish

Fresh

Prepare fresh fish in the usual way, i.e. clean, gut and fillet.

Frozen food

Fish does not need to be fully defrosted before cooking. Defrost so that the surface is sufficiently thawed to take herbs and seasoning. Depending on the thickness of the fish, 2 - 5 minutes should be enough.

Preparation

Add some lemon or lime juice to fish before cooking. The citric acid helps the flesh stay firm.

It is not necessary to season fish with salt when cooking with steam as this method retains the minerals which give the fish its unique flavour.

Cooking containers

If using a perforated container, grease it first.

Shelf level

When cooking fish in a perforated container at the same time as cooking other types of food in other containers, place the container with the fish directly above the glass or collecting tray (depending on the model) to catch any liquid and so avoid any transfer of flavours to other food.

Temperature

85 °C – 90 °C

For gently cooking delicate types of fish, such as sole.

100 °C

For cooking firmer types of fish, e.g. cod and salmon.
Also for cooking fish in sauce or stock.

Duration

The cooking duration depends on the thickness and the texture of the fish, and not on the weight. The thicker the fish, the longer the cooking duration. A 3 cm thick piece of fish weighing 500 g will take longer to cook than a 2 cm thick piece of fish weighing 500 g.

The longer fish cooks, the firmer its flesh will become. Use the cooking durations given in the chart. If you find that the fish is not cooked sufficiently only cook it for a few minutes more.

When cooking fish in sauce or stock, we recommend that you increase the cooking duration quoted by a few minutes.

Tips

- Adding herbs and spices, such as dill, will help bring out the full flavour of the fish.
- Cook large fish in swimming position. To help maintain the shape of the fish, place a small cup or similar upside down in the cooking container, and arrange the fish belly-side down over the cup.
- You can use any fish scraps, e.g. fish heads, bones, tails etc to make a **fish stock**. Place the fish scraps together with some mixed vegetables in a solid cooking container and add cold water. Cook at 100 °C for 60 to 90 minutes. The longer the cooking duration, the stronger the stock.
- Preparing fish **au bleu** is a method involving cooking the fish in water with vinegar, at different proportions depending on the recipe. It is important not to damage the skin of the fish. This method is suitable for cooking carp, trout, tench, eel and salmon.

Settings

Automatic programmes Auto | Fish | ... |

or

Steam cooking 

Temperature: see table

Cooking duration: see table

Steam cooking

Fish	🌡️ [°C]	🕒 [min]
Eel	100	5–7
Perch fillet	100	8–10
Seabream fillet	85	3
Trout, 250 g	90	10–13
Halibut fillet	85	4–6
Cod fillet	100	6
Carp, 1.5 kg	100	18–25
Salmon fillet	100	6–8
Salmon steak	100	8–10
Salmon trout	90	14–17
Basa fillet	85	3
Rosefish fillet	100	6–8
Haddock fillet	100	4–6
Plaice fillet	85	4–5
Monkfish fillet	85	8–10
Sole fillet	85	3
Turbot fillet	85	5–8
Tuna fillet	85	5–10
Pike perch fillet	85	4

🌡️ Temperature 🕒 Duration

Meat

Fresh

Prepare the meat in the usual way.

Frozen food

Meat should be thoroughly defrosted before cooking in the steam oven (see “Defrosting with steam”).

Preparation

For meat which needs to be seared before being cooked, e.g. for a stew, sear the meat in a pan on the hob first.

Duration

The cooking duration depends on the thickness and the texture of the meat, and not on the weight. The thicker the piece of meat, the longer the cooking duration. A piece of meat weighing 500 g which is 10 cm thick will take longer to cook than a piece of meat weighing 500 g which is 5 cm thick.

Tips

- To retain the **flavourings**, use a perforated cooking container. Place an unperforated cooking container underneath in order to collect the concentrate. You can use the concentrate to enhance your sauces or freeze it for later use.
- Boiling fowl, back or top rib and meat bones can be used to make **stock**. Place the meat together with the bones and some mixed vegetables in a cooking container and add cold water. The longer the cooking duration, the stronger the stock.

Settings

Automatic programmes  | Meat | ... |

or

Steam cooking 

Temperature: 100 °C

Cooking duration: see table

Steam cooking

Meat	🕒 [min]
Leg steak, covered with water	110–120
Pork knuckle	135–140
Chicken breast	8–10
Hock	105–115
Top rib, covered with water	110–120
Veal strips	3–4
Gammon slices	6–8
Lamb stew	12–16
Poularde	60–70
Turkey roulades	12–15
Turkey escalopes	4–6
Short rib, covered with water	130–140
Beef goulash	105–115
Whole chicken, covered with water	80–90
Topside	110–120

🕒 Cooking duration

Rice

Rice swells when cooked and needs to be cooked in liquid. The proportion of rice to liquid will vary depending on the type of rice.

The rice absorbs all the liquid during the cooking process and so none of the nutrients are lost.

Settings

Automatic programmes  | Rice | ... |

or

Steam cooking 

Temperature: 100 °C

Cooking duration: see table

	Ratio Rice : Liquid	 [min]
Basmati rice	1 : 1.5	15
Parboiled rice	1 : 1.5	23–25
Round grain rice		
Pudding rice	1 : 2.5	30
Risotto rice	1 : 2.5	18–19
Brown rice	1 : 1.5	26–29
Wild rice	1 : 1.5	26–29

 Duration

Steam cooking

Grain

Grain swells during cooking and needs to be cooked in liquid. The proportion of grain to liquid depends on the type of grain.

Grain can be cooked whole or cracked.

Settings

Automatic programmes  | Grain | ... |

or

Steam cooking 

Temperature: 100 °C

Cooking duration: see table

	Ratio Grain : Liquid	 [min]
Amaranth	1 : 1.5	15–17
Bulgur	1 : 1.5	9
Green spelt, whole	1 : 1	18–20
Green spelt, cracked	1 : 1	7
Oats, whole	1 : 1	18
Oats, cracked	1 : 1	7
Millet	1 : 1.5	10
Polenta	1 : 3	10
Quinoa	1 : 1.5	15
Rye, whole	1 : 1	35
Rye, cracked	1 : 1	10
Wheat, whole	1 : 1	30
Wheat, cracked	1 : 1	8

 Duration

Pasta

Dry pasta

Dry pasta swells when it is cooked and needs to be cooked in liquid. The liquid must cover the pasta. Using hot liquid gives better results.

Increase the cooking time stated by the manufacturer by approx. $\frac{1}{3}$.

Fresh food

Fresh pasta, such as the kind you can buy from the supermarket chilled counter, does not need to absorb water. Cook fresh pasta in a greased perforated container.

Separate any pieces of pasta which have stuck together and spread them out in the cooking container.

Settings

Automatic programmes  | Pasta | ... |

or

Steam cooking 

Temperature: 100 °C

Cooking duration: see table

Fresh	 [min]
Gnocchi	2
Knöpfli	1
Ravioli	2
Spätzle	1
Tortellini	2
Dry pasta, covered with water	
Tagliatelli	14
Vermicelli	8

 Duration

Steam cooking

Dumplings

Ready made boil-in-the-bag dumplings need to be well covered with water as otherwise they can fall apart. This is because even though they have been soaked in water beforehand they will not absorb enough moisture.

Cook fresh dumplings in a greased, perforated container.

Settings

Automatic programmes  | Pasta | ... |

or

Steam cooking 

Temperature: 100 °C

Cooking duration: see table

	 [min]
Sweet dumplings	30
Yeast dumplings	20
Boil-in-the-bag potato dumplings	20
Boil-in-the-bag bread dumplings	18–20

 Duration

Dried pulses

Soak pulses for at least 10 hours in cold water before cooking. Soaking makes the pulses more digestible and shortens the cooking duration required. Soaked pulses must be covered with liquid during cooking.

Lentils do not need to be soaked before cooking.

With unsoaked pulses a certain ratio of pulses to liquid is required depending on variety.

Settings

Automatic programmes  | Pulses | ... |

or

Steam cooking 

Temperature: 100 °C

Cooking duration: see table

Soaked	
	 [min]
Beans	
Kidney beans	55–65
Adzuki beans	20–25
Black beans	55–60
Pinto beans	55–65
Haricot beans	34–36
Peas	
Yellow split peas	40–50
Green split peas	27

 Duration

Steam cooking

Unsoaked		
	Ratio Pulses : Liquid	🕒 [min]
Beans		
Kidney beans	1 : 3	130–140
Adzuki beans	1 : 3	95–105
Black beans	1 : 3	100–120
Pinto beans	1 : 3	115–135
Haricot beans	1 : 3	80–90
Lentils		
Brown lentils	1 : 2	13–14
Red lentils	1 : 2	7
Peas		
Yellow split peas	1 : 3	110–130
Green split peas	1 : 3	60–70

🕒 Duration

Hen's eggs

Use a perforated container to boil eggs in the steam oven.

The eggs do not need to be pierced before cooking as they are gradually warmed during the heating up phase and so do not burst when they are cooked with steam.

When using a solid container for making egg dishes such as scrambled eggs, remember to grease it first.

Settings

Automatic programmes  | Hen's eggs | ... |

or

Steam cooking 

Temperature: 100 °C

Cooking duration: see table

	 [min]
Small soft medium hard	3 5 9
Medium soft medium hard	4 6 10
Large soft medium hard	5 6–7 12
Extra large soft medium hard	6 8 13

 Duration

Steam cooking

Fruit

Cook fruit in a solid container so that none of the juice is lost. If you wish to cook fruit in a perforated container, place a solid container directly underneath it to collect the juice.

Tip: You can use the juice which has collected in the solid container to make a glaze for a fruit flan.

Settings

Automatic programmes  | Fruit | ... |

or

Steam cooking 

Temperature: 100 °C

Cooking duration: see table

	 [min]
Apple chunks	1–3
Pear chunks	1–3
Cherries	2–4
Mirabelle plums	1–2
Nectarine/peach chunks	1–2
Plums	1–3
Quinces, diced	6–8
Rhubarb chunks	1–2
Gooseberries	2–3

 Cooking duration

Sausages

Settings

Automatic programmes  | Sausages
| ... |

or

Steam cooking 

Temperature: 90 °C

Cooking duration: see table

Sausages	 [min]
Frankfurters	6–8
Bologna sausages	6–8
Veal sausages	6–8

 Duration

Shellfish

Preparation

Defrost frozen shellfish before cooking with steam.

Peel, remove and discard the intestines, and then wash the shellfish.

Cooking containers

If using a perforated container, grease it first.

Duration

The longer shellfish are cooked, the tougher they become. Use the cooking durations given in the chart.

When cooking shellfish in sauce or stock, we recommend that you increase the cooking duration quoted by a few minutes.

Settings



Automatic programmes  | Shellfish | ... |

or

Steam cooking 

Temperature: see table

Cooking duration: see table

	 [°C]	 [min]
Crevettes	90	3
Prawns	90	3
King prawns	90	4
Small shrimps	90	3
Lobster	95	10–15
Large shrimps	90	3

 Temperature  Duration

Steam cooking

Mussels

Fresh food

 Danger of food poisoning from spoiled mussels.
Spoiled mussels can cause food poisoning.
Only cook mussels which are closed.
Do not eat mussels which have not opened after being cooked.

Steep fresh mussels in water for a few hours before cooking to rinse out any sand. Then scrub the mussels thoroughly to clean them.

Frozen food

Defrost frozen mussels before cooking.

Duration

The longer mussels are cooked, the tougher they become. Use the cooking durations given in the chart.

Settings



Automatic programmes  | Mussels and clams | ... |

or

Steam cooking 

Temperature: see table

Cooking duration: see table

	 [°C]	 [min]
Barnacles	100	2
Cockles	100	2
Mussels	90	12
Scallops	90	5
Razor clams	100	2–4
Venus clams	90	4

 Temperature  Duration

Menu cooking (cooking whole meals)

Before cooking meals with the manual menu cooking function, switch off steam reduction (see “Settings – Steam reduction”).

When cooking a menu, you can combine different foods with different cooking durations, e.g. fish fillet with rice and broccoli.

The food is placed in the steam oven compartment at different times so that each item is ready at the same time.

Shelf level

Place foods that produce a lot of liquids (e.g. fish) or have a distinctive colour (e.g. beetroot) directly above the glass tray or condensate tray (depending on the model). This avoids any transfer of flavour or colour to other food and prevents liquid dripping onto food below it.

Temperature

Whole meals should be cooked at a temperature of 100 °C as this is the temperature required to cook the majority of foods.

Do not cook a whole meal at the lowest temperature when different temperatures are required for different types of food, e.g. 85 °C for seabream and 100 °C for potatoes.

If the recommended cooking temperature for the food is 85 °C for example, try cooking it at 100 °C and testing the result. Some delicate types of fish with a soft structure, e.g. sole and plaice will become very firm when cooked at 100 °C.

Duration

If you are increasing the recommended temperature, shorten the cooking duration by approx. $\frac{1}{3}$.

Example

Food cooking durations

(see cooking tables in “Steam cooking”)

Parboiled rice	24 minutes
Rosefish fillet	6 minutes
Broccoli	4 minutes

Calculation of set cooking durations:

24 minutes minus

6 minutes = 18 minutes (1st cooking duration: rice)

6 minutes minus 4 minutes = 2 minutes (2nd cooking duration: rosefish fillet)

Remaining time = 4 minutes (3rd cooking duration: broccoli)

Cooking duration	24 min. – rice		
		6 min. – fish fillet	
			4 min. – broccoli
Settings	18 min.	2 min.	4 min.

Steam cooking

Cooking a whole menu

- Place the rice in the oven compartment first.
- Set the 1st cooking duration: 18 minutes.
- After the 18 minutes, place the fish into the appliance.
- Set the 2nd cooking duration: 2 minutes.
- After the 2 minutes, place the broccoli into the appliance.
- Set the 3rd cooking duration: 4 minutes.

Sous-vide (vacuum) cooking

With this gentle cooking method, food is cooked slowly and at a low, constant temperature in vacuum packaging.

With vacuum cooking, no moisture evaporates during cooking and all nutrients and flavours are retained.

The cooking result has an intensive taste and food is cooked evenly.

Use only fresh food which is in a good condition.

Ensure hygienic conditions and that food has not been out of the refrigerator too long, e.g. during transportation.

Use only heat-stable, boiling-resistant vacuum sealing bags.

Do not cook food in the sales packaging, such as vacuum-packed frozen food as it is possible that the packaging used is not suitable for vacuum cooking.

Do not use the vacuum sealing bag more than once.

Vacuum-seal the food in a chamber system vacuum sealer only.

Sous-vide (vacuum) cooking

Important usage notes

For best cooking results, follow the instructions below:

- Use herbs and spices more sparingly than with conventional methods because the impact on the taste of the food will be stronger.
You can also cook the food unseasoned and add seasoning after cooking.
- The cooking duration is reduced when salt, sugar and liquids are added.
- The food becomes firmer if acidic ingredients such as lemon or vinegar are added.
- Do not use alcohol or garlic as this can produce unpleasant flavours.
- Only use vacuum sealing bags that match the size of the food. If the vacuum sealing bag is too big, too much air can remain inside.
- If you want to cook several items of food in one vacuum sealing bag, put them side-by-side in the bag.
- If you want to cook food in several vacuum sealing bags at once, put the bags side-by-side on the rack.
- The cooking durations depend on the thickness of the food.
- With higher temperatures and/or longer cooking durations, the appliance may run low on water. Check the display from time to time.
- Keep the door closed during the cooking programme. Opening the door will prolong the cooking programme and can change the cooking result.
- Cooking at a lower temperature and for a longer duration can result in increased residual water in the cooking compartment. This does not affect the cooking results.
- Temperatures and cooking durations from sous-vide recipes cannot always be emulated exactly. Alter the settings to achieve the degree of cooking you want.

Sous-vide (vacuum) cooking

Tips

- In order to reduce cooking times, you can vacuum-seal food items 1–2 days before the cooking programme. Store the vacuum-sealed food in the refrigerator at no more than 5 °C. In order to preserve quality and flavour, the food should be cooked no later than 2 days afterwards.
- Freeze liquids such as marinades before vacuum-sealing to prevent them from escaping from the bag.
- Fold the edges of the vacuum sealing bag outwards for filling. This will give you clean, perfect seams.
- If you do not want to eat the food straight after cooking, put it in iced water immediately and allow it to cool down completely. After this, store the food at temperatures no greater than 5 °C.
This way, you can retain the food's quality and flavour while keeping it fresh for longer.
Exception: Poultry must be eaten straight after the cooking programme.
- After cooking, cut the vacuum sealing bag on all sides for easier access to the food.
- Briefly fry meat and firm types of fish (such as salmon) before serving for a roasted aroma.
- Use the stock or marinade of vegetables, fish or meat to make a sauce.
- Serve the food on pre-warmed plates.

Sous-vide (vacuum) cooking

Using the Sous-vide function

- Rinse the food with cold water and dry it.
- Place the food in a vacuum sealing bag and add spices or liquid if desired.
- Vacuum-seal the food in a chamber system vacuum sealer.
- Place the glass tray on shelf level 1.
- For the best cooking results place the rack on shelf level 2.
- Place the vacuum-sealed food on the rack (next to each other if there are several bags).
- Select Sous-vide .
- Change the recommended temperature if necessary.
- Confirm with *OK*.
- Set further settings as necessary (see “Operation”).

Possible reasons for unsatisfactory results

The bag has opened:

- The seal was not clean or strong enough and has opened.
- The bag was damaged by a sharp bone.

The food has an unpleasant or strange taste:

- Incorrect storage of the food; the food was kept out of the refrigerator for too long.
- The food was contaminated with bacteria before it was vacuum sealed.
- Too much of ingredients such as spices was added.
- The bag or seal was not in perfect order.
- The vacuum was insufficient.
- The food was not eaten or chilled immediately after cooking.

Sous-vide (vacuum) cooking

The cooking durations given in the tables are guidelines only. We recommend selecting the shorter duration initially. You can cook for longer if necessary. The cooking duration only begins when the set temperature is reached.

Food	Added in advance		🌡️ [°C]	⌚ [min]
	Sugar	Salt		
Fish				
Atlantic cod fillet, 2.5 cm thick		x	54	35
Salmon fillet, 2–3 cm thick		x	52	30
Monkfish fillet		x	62	18
Pikeperch fillet, 2 cm thick		x	55	30
Vegetables				
Cauliflower florets, medium to large		x	85	40
Hokkaido pumpkin, sliced		x	85	15
Kohlrabi, sliced		x	85	30
Asparagus, white, whole	x	x	85	22–27
Sweet potato, sliced		x	85	18
Fruit				
Pineapple, sliced	x		85	75
Apples, sliced	x		80	20
Baby bananas, whole			62	10
Peaches, halved	x		62	25–30
Rhubarb chunks			75	13
Plums, halved	x		70	10–12
Other				
Beans, white, soaked in a ratio of 1:2 (beans to liquid)		x	90	240
Prawns, peeled and deveined		x	56	19–21
Hen's egg, whole			65–66	60
Scallops, removed from shell			52	25
Shallots, whole	x	x	85	45–60

🌡️ Temperature ⌚ Duration

Sous-vide (vacuum) cooking

Food	Added in advance		🌡️ [°C]		🕒 [min]
	Sugar	Salt	Medium*	Done*	
Meat					
Duck breast, whole		x	66	72	35
Saddle of lamb			58	62	50
Beef fillet steak, 4 cm thick			56	61	120
Beef rump steak, 2.5 cm thick			56	–	120
Pork tenderloin, whole		x	63	67	60

🌡️ Temperature 🕒 Duration

* Degree of cooking

The “well done” cooking degree uses a higher core temperature than “medium”, but results are not the same as being well-done in the traditional sense.

Reheating

Only reheat brassicas, such as kohlrabi and cauliflower, in combination with a sauce. Without sauce, an unpleasant cabbage-like taste and grey-brown colour may develop.

Food with a short cooking duration or which continues cooking during reheating, such as fish, is not suitable for reheating.

Preparation

Place the cooked food into ice water for approx. 1 hour directly after cooking. The rapid cooling prevents the food from continuing to cook, which helps retain the optimum cooked condition. Then store the food in the refrigerator at a maximum temperature of 5 °C.

Please note that the quality of the food decreases the longer it is stored.

We recommend that you do not store the food in the refrigerator for longer than 5 days before reheating.

Settings

Sous-vide 

Temperature: see table

Duration: see table

Sous-vide (vacuum) cooking

Reheating with the Sous-vide function

The durations specified in the table are guidelines only. You can increase the duration if necessary. The cooking duration only begins when the set temperature is reached.

Food	🌡️ [°C]		🕒 ² [min]
	Medium ¹	Done ¹	
Meat			
Saddle of lamb	58	62	30
Beef fillet steak, 4 cm thick	56	61	30
Beef rump steak, 2.5 cm thick	56	–	30
Pork tenderloin, whole	63	67	30
Vegetables			
Cauliflower florets, medium to large ³	85		15
Kohlrabi, sliced ³	85		10
Fruit			
Pineapple, sliced	85		10
Other			
Beans, white, soaked in a ratio of 1:2 (beans to liquid)	90		10
Shallots, whole	85		10

🌡️ Temperature, 🕒 Time

1 Degree of cooking

The “well done” cooking degree uses a higher core temperature than “medium”, but results are not the same as being well-done in the traditional sense.

2 Durations apply to vacuum-sealed food with an initial temperature of approx. 5 °C (refrigerator temperature).

3 Reheat only in sauce.

Reheating with steam

To reheat food which was cooked using the sous-vide method, use the Sous-vide  function (see “Sous-vide – Reheating”).

The steam oven is very effective at reheating food gently, without drying it out or cooking it further. The food will reheat evenly and does not need to be stirred during the reheating process.

You can reheat individual dishes or plated meals which have been prepared previously (e.g. meat, vegetables and potatoes).

Suitable containers

Small quantities can be reheated on a plate, larger quantities should be placed in a cooking container.

Time

The number of plates or containers has no bearing on the time.

The times listed in the table relate to an average portion per plate. Increase the duration for larger quantities.

Tips

- Do not reheat large items, such as a joint of roast meat, whole. Divide it into portions and reheat these as plated meals.
- Compact items, such as stuffed peppers, roulades or dumplings, should be cut in half.
- Reheat sauces separately. Exceptions are dishes such as goulash, which is cooked in sauce.
- Cover food when reheating it to avoid steam condensing on the crockery.
- Please note that breaded items, such as schnitzel, will not retain their crispness when they are reheated.

Heating food

- Cover the food being warmed up with a plate or foil that is resistant to temperatures up to 100 °C and to steam.
- Place the food on the rack or in a cooking container.

Settings

Reheat  | Steam cooking

or

Steam cooking 

Temperature: 100 °C

Duration: see table

Further applications

The durations specified in the table are guidelines only. We recommend selecting the shorter duration initially. You can increase the duration if necessary.

Food	🕒* [min]
Vegetables	
Carrots Cauliflower Kohlrabi Beans	6–7
Side dishes	
Pasta Rice	3–4
Potatoes, halved lengthways	12–14
Dumplings	15–17
Meat and poultry	
Sliced meat, 1.5 cm thick Roulades, sliced Goulash Lamb stew	5–6
Meatballs	13–15
Chicken escalopes Turkey escalopes	7–8
Fish	
Fish fillets, 2 cm thick	6–7
Fish fillets, 3 cm thick	7–8
Plated meals	
Spaghetti with tomato sauce	13–15
Roast pork, potatoes, vegetables	12–14
Stuffed pepper (halved), rice	13–15
Chicken fricassee, rice	7–8
Vegetable soup	2–3
Creamy soup	3–4

Further applications

Food	🕒* [min]
Consommé	2-3
Stew	4-5

🕒 Duration

* These times apply to food heated on a plate and covered with a plate.

Further applications

Defrosting with steam

It is much quicker to defrost food in the steam oven than at room temperature.

 Risk of infection from bacteria. Bacteria such as salmonella can cause life-threatening food poisoning.

It is particularly important to observe food hygiene rules when defrosting fish and meat, and in particular when defrosting poultry.

Do not use the liquid produced during defrosting.

Process the food as required as soon as it has been defrosted.

Temperature

60 °C is the best temperature for defrosting.

Exception: 50 °C for minced meat and game

Before and after defrosting

Remove any packaging before defrosting.

Exceptions: Leave bread, biscuits and cakes in their packaging as otherwise they will absorb moisture and become soft.

Allow food to stand at room temperature for a few minutes after defrosting. The standing time is necessary to allow the even distribution of heat from the outside to the inside.

Cooking containers

Use a perforated container with a glass or condensate tray underneath it when defrosting food which will drip, such as poultry. This way food will not be lying in defrosted liquid.

Food which does not drip can be defrosted in a solid container.

Tips

- Fish, for instance, does not need to be fully defrosted before cooking. Defrost so that the surface is sufficiently thawed to take herbs and seasoning. Depending on the thickness of the fish, 2–5 minutes is generally enough.
- When defrosting food which has frozen together, e.g. berries and meat portions, separate them half-way through the defrosting time.
- Do not refreeze food once it has thawed.
- Defrost frozen pre-cooked meals according to the instructions on the packaging.

Settings

Defrost  | Steam cooking

or

Steam cooking 

Temperature: see table

Defrosting duration: see table

Standing time: see table

Further applications

The durations specified in the table are guidelines only. We recommend selecting the shorter defrosting time initially. You can increase the defrosting time longer if necessary.

Frozen food	Quantity	🌡️ [°C]	🕒 [min]	⌚ [min]
Dairy products				
Sliced cheese	125 g	60	15	10
Quark	250 g	60	20–25	10–15
Cream	250 g	60	20–25	10–15
Soft cheese	100 g	60	15	10–15
Fruit				
Apple sauce	250 g	60	20–25	10–15
Apple chunks	250 g	60	20–25	10–15
Apricots	500 g	60	25–28	15–20
Strawberries	300 g	60	8–10	10–12
Raspberries/currants	300 g	60	8	10–12
Cherries	150 g	60	15	10–15
Peaches	500 g	60	25–28	15–20
Plums	250 g	60	20–25	10–15
Gooseberries	250 g	60	20–22	10–15
Vegetables				
Frozen in a block	300 g	60	20–25	10–15
Fish				
Fish fillets	400 g	60	15	10–15
Trout	500 g	60	15–18	10–15
Lobster	300 g	60	25–30	10–15
Small shrimps	300 g	60	4–6	5
Ready meals				
Meat, vegetables, side dishes/ stew/soup	480 g	60	20–25	10–15
Meat				
Roast meat, sliced	125–150 g each	60	8–10	15–20

Further applications

Frozen food	Quantity	🌡️ [°C]	🕒 [min]	⌚ [min]
Minced meat	250 g	50	15–20	10–15
	500 g	50	20–30	10–15
Goulash	500 g	60	30–40	10–15
	1000 g	60	50–60	10–15
Liver	250 g	60	20–25	10–15
Saddle of hare	500 g	50	30–40	10–15
Saddle of venison	1000 g	50	40–50	10–15
Cutlets/chops/sausages	800 g	60	25–35	15–20
Poultry				
Chicken	1000 g	60	40	15–20
Chicken thighs	150 g	60	20–25	10–15
Chicken escalopes	500 g	60	25–30	10–15
Turkey legs	500 g	60	40–45	10–15
Baked goods				
Puff pastries/yeast-dough pastry	–	60	10–12	10–15
Creamed mixture cakes/biscuits	400 g	60	15	10–15
Bread/rolls				
Bread rolls	–	60	30	2
Rye bread, sliced	250 g	60	40	15
Wholegrain bread, sliced	250 g	60	65	15
White bread, sliced	150 g	60	30	20

🌡️ Temperature 🕒 Defrosting time ⌚ Standing time

Blanching

Blanch vegetables before freezing them. Blanching helps maintain the quality of the produce when it is frozen.

Blanching vegetables also helps them retain their original colour.

- Put the prepared vegetables into a perforated cooking container.
- Once blanched, plunge the vegetables into ice cold water to cool them down quickly. Drain them well.

Settings

Further  | Blanching

or

Steam cooking 

Temperature: 100 °C

Blanching time: 1 minute

Bottling

Only use unblemished, fresh produce which is in good condition for bottling.

Glass jars

Use clean glass jars and accessories and check them for any defects. Glass jars with twist off lids or glass lids with a rubber seal are suitable.

Make sure that all the jars are the same size so that bottling is carried out evenly.

After you have filled the jars with the bottled produce, clean the glass rims with a clean cloth and hot water and then seal the jars.

Fruit

Sort fruit carefully, rinse it briefly but thoroughly and allow it to drain. Take great care when cleaning soft fruit as it is very delicate and squashes easily.

Remove any peel, stalks, cores or stones. Cut up large fruit. For example, cut apples into slices.

If you are bottling fruit with stones (e.g. plums, apricots) without removing the stones, pierce the fruit several times with a fork or wooden skewer as otherwise it will burst.

Further applications

Vegetables

Rinse, clean and cut up vegetables.

Vegetables should be blanched before bottling to help them retain their colour (see “Special applications” – “Blanching”).

Fill volume

Fill the glass jars with produce up to a maximum of 3 cm below the rim. Do not pack it down as this will damage the cell walls of the produce. Tap the jar gently onto a cloth to help distribute the contents evenly. Fill the jars with liquid. The produce must be completely covered.

Use a sugar solution for fruit and a salt or vinegar solution for vegetables.

Tips

- Make use of residual heat by leaving the jars in the oven for 30 minutes after it has switched off.
- Then cover the jars with a cloth and allow to cool for approx. 24 hours.

Bottling food

- Place the rack in shelf level 1.
- Place the jars on the rack. The jars must not touch each other.

Settings

Further  | Bottling

or

Steam cooking 

Temperature: see table

Bottling duration: see table

Further applications

Food to be bottled	🌡️ [°C]	🕒* [min]
Berries		
Currants	80	50
Gooseberries	80	55
Cranberries	80	55
Fruit with stones		
Cherries	85	55
Mirabelle plums	85	55
Plums	85	55
Peaches	85	55
Greengages	85	55
Fruit with pips		
Apples	90	50
Apple sauce	90	65
Quinces	90	65
Vegetables		
Beans	100	120
Broad beans	100	120
Gherkins	90	55
Beetroot	100	60

🌡️ Temperature 🕒 Duration

* Bottling times apply to 1.0 l jars. If using 0.5 l jars, reduce the duration by 15 minutes. If using 0.25 l jars, reduce the duration by 20 minutes.

Further applications

Disinfect items

The steam oven can be used to disinfect baby bottles and other containers so that at the end of the programme they are as germ free as they would have been had they been boiled. Check beforehand that all parts, teats etc. are declared by the manufacturer to be heat resistant to 100 °C and also that they can withstand hot steam.

Dismantle, clean and thoroughly rinse baby bottles. All parts of the bottles must be completely dry before they are reassembled to keep them germ free.

- Place the individual items on the rack or in a perforated container (on their sides or with the opening facing downwards) ensuring that they do not touch one another to allow hot steam to reach them from all sides.

Settings

Further  | Disinfect items

Duration: 1 minute to 10 hours

or

Steam cooking 

Temperature: 100 °C

Duration: 15 minutes

Prove dough

- Prepare the dough according to the recipe.
- Place the dough, uncovered, in a bowl on the rack.

Settings

Further  | Prove dough

Duration: as per recipe instructions

or

Steam cooking 

Temperature: 40 °C

Duration: as per recipe instructions

Heating damp flannels

- Moisten the flannels and then roll them up.
- Place them beside one another in a perforated cooking container.

Settings

Automatic programmes  | Special | Heat damp flannels

or

Steam cooking 

Temperature: 70 °C

Cooking duration: 2 minutes

Dissolve gelatine

- Soften **gelatine leaves** by leaving them in a bowl of cold water for 5 minutes. The gelatine leaves have to be fully covered with water. Remove the gelatine leaves from the bowl and squeeze them out. Empty the bowl. Place the squeezed gelatine leaves back in the bowl.
- Place **gelatine powder** in a bowl and add water according to the instructions on the packaging.
- Cover the bowl and place on the rack.

Settings

Automatic programmes  | Special | Dissolve gelatine

or

Steam cooking 

Temperature: 90 °C

Cooking duration: 1 minute

Further applications

Decrystallise honey

- Loosen the lid and place the jar of honey in a perforated container.
- Stir the honey once during the cooking duration.

Settings

Automatic programmes  | Special | Decrystallise honey

or

Steam cooking 

Temperature: 60 °C

Cooking duration: 90 minutes (irrespective of the size of jar or the amount of honey in the jar)

Melt chocolate

You can use the steam oven for melting any type of chocolate.

When using a cake covering, place it in a perforated cooking container, leaving it in its packaging.

- Break the chocolate into small pieces.
- Place larger quantities in a solid cooking container and smaller quantities in a cup or a bowl.
- Cover the container or the dish with a lid or with foil that is resistant to temperatures up to 100 °C and to hot steam.
- Stir large quantities once halfway through cooking.

Settings

Automatic programmes  | Special | Melt chocolate

or

Steam cooking 

Temperature: 65 °C

Cooking duration: 20 minutes

Make yoghurt

To make yoghurt, you will need either fresh live yoghurt or yoghurt culture, obtainable from health food shops.

Use natural yoghurt with live culture and without additives. Heat-treated yoghurt is not suitable.

The yoghurt must be fresh (short storage time).

You can use either unchilled long-life milk or fresh milk.

Long-life milk can be used as it is – no further preparation is required. Fresh milk must first be heated to 90 °C (do not boil it) and then cooled down to 35 °C. Fresh milk will give a better set than long-life milk.

The yoghurt and milk should have the same percentage fat.

Do not move or shake the jars whilst the yoghurt is thickening.

Immediately after preparation, leave the yoghurt to cool in the fridge.

How well home-prepared yoghurt sets will depend on the consistency, fat content and the cultures used in the starter yoghurt. Not all yoghurts are suitable for use as starter yoghurt.

Tip: When using yoghurt enzyme, yoghurt can be made from a milk / cream mixture. Mix $\frac{3}{4}$ litre milk with $\frac{1}{4}$ litre cream.

- Mix 100 g yoghurt with 1 l milk or make up the mixture with yoghurt enzyme, following the instructions on the packaging.
- Pour the mixture into jars and seal the jars.
- Place the sealed jars into a perforated cooking container or on the rack. The jars must not touch each other.
- Straight after the cooking duration has finished, place the jars in the refrigerator. Take care not to shake the jars unnecessarily.

Settings

Automatic programmes  | Special |
Make yoghurt

or

Steam cooking 
Temperature: 40 °C
Duration: 5 hours

Possible reasons for unsatisfactory results

Yoghurt has not set:

Incorrect storage of starter yoghurt, too much time out of the refrigerator, e.g. in transportation, damaged packaging, milk not sufficiently heated.

Liquid has separated:

The jars were moved, yoghurt was not cooled down quickly enough.

Yoghurt is gritty:

Milk was overheated or in poor condition, milk and starter yoghurt not evenly stirred.

Further applications

Cook bacon

The bacon does not brown.

- Place the bacon (diced or rashers) in a solid cooking container.
- Cover the container with foil that is temperature-resistant up to 100 °C and resistant to steam.

Settings

Automatic programmes  | Special |
Render fat

or

Steam cooking 

Temperature: 100 °C

Cooking duration: 4 minutes

Sweat onions

Sweating means cooking the onions in their own juices, with the addition of a little fat if necessary.

- Cut the onions up into small pieces and place them in a solid cooking container with a little butter.
- Cover the container with foil that is temperature-resistant up to 100 °C and resistant to steam.

Settings

Automatic programmes  | Special |
Sweat onions

or

Steam cooking 

Temperature: 100 °C

Cooking duration: 4 minutes

Extracting juice with steam

This appliance is ideal for extracting juice from soft, firm and hard fruit.

It is best to use overripe fruit, as the riper the fruit, the greater the quantity of juice produced. Very ripe fruit will also produce a more intense flavour.

Preparation

Sort and clean the fruit. Cut out any blemishes.

Remove the stalks from grapes and morello cherries as these are bitter. Berries do not need to have their stalks removed.

Cut larger fruit such as apples into chunks of approximately 2 cm in size. The harder the fruit, the smaller the pieces should be.

Tips

- Try experimenting with mild and tart fruit.
- Adding sugar will increase the quantity of juice produced and improve the flavour. Sprinkle the fruit with sugar and leave to absorb for a few hours before juicing. For 1 kg of sweet fruit add 50–100 g of sugar, and for 1 kg of tart fruit add 100–150 g of sugar.
- If you wish to bottle the juice rather than consume it straight away, pour it whilst hot into hot, sterilised bottles, and then seal immediately with sterilised tops.

Extracting juice from fruit

- Put the prepared fruit into a perforated cooking container.
- Place a solid container or a glass or condensate tray (depending on the model) underneath to catch the juice.

Settings

Steam cooking 

Temperature: 100 °C

Duration: 40–70 minutes

Further applications

Skinning vegetables and fruit

- Cut a cross in the top of tomatoes, nectarines, etc. This will allow the skin to be removed more easily.
- Place the fruit/vegetables in a perforated cooking container.
- To blanch almonds, it is important to plunge them into cold water as soon as they are taken out of the oven, otherwise the skin cannot be removed.

Settings

Steam cooking 

Temperature: 100 °C

Duration: see table

Food	 [min]
Apricots	1
Almonds	1
Nectarines	1
Peppers	4
Peaches	1
Tomatoes	1

 Duration

Apple storage

You can treat homegrown apples in the steam oven to increase the length of time for which you can store them. Once treated, the apples will keep for 5 to 6 months when stored in a dry, cool and well-ventilated place. This method is only suitable for apples and not for other types of fruit.

Settings

Automatic programmes  | Fruit | Apples | Whole

or

Steam cooking 

Temperature: 50 °C

Preserving time: 5 minutes

Making eierstich

- Mix 6 eggs with 375 ml milk (do not beat into a foam).
- Season the egg and milk mixture and pour into a solid cooking container greased with a little butter.

Settings

Steam cooking 

Temperature: 100 °C

Cooking duration: 4 minutes

Rapid steam cooking

You can defrost, reheat and cook food with a combination of steam and microwave power with the Rapid steam cooking  function.



During the heating-up phase, the oven compartment is initially heated to the set temperature using just steam power. As soon as this temperature has been reached, the microwave switches on so that the steam generator and magnetron are both switched on throughout the entire cooking phase.

Just like steam-only cooking, the cooking duration does not begin until the set temperature is reached.

The Rapid steam cooking  combined function has a number of advantages, including the following:

- Shorter cooking durations, as food cooks more quickly than using steam power alone
- Food will not overcook or dry out as it can with microwave-only power
- Food can be defrosted and reheated in a single process
- Food does not need to be stirred during the cooking programme

Defrosting and reheating with the Rapid steam cooking function

	 [W]	 [min]	 [°C]	Container
Reheating plated meals ^{1, 2}				
Pasta with tomato sauce, 400 g (ratio 5:3)	300	7–8	90	Deep plate
Meatballs with potato purée and red cabbage, 450 g	300	11	85	Deep plate
Defrosting and reheating ^{1, 2}				
Frozen casseroles/soups, 250 g	300	10–11	95	Bowl
Frozen casseroles/soups, 500 g	300	15–16	90	Bowl

 Microwave power,  Duration,  Temperature

¹ Do **not** use a cover.

² Place the food in the glass tray on shelf level 1.

Rapid steam cooking

Cooking new potatoes (waxy)

- Place the glass tray on shelf level 1.
- Place the washed new potatoes adjacent to each other in a perforated cooking container.

Settings



Automatic programmes  | Vegetables | Potatoes | Unpeeled potatoes | Firm | ... | Rapid steam cooking

or

Rapid steam cooking 

Microwave power/temperature: 80 W + 100 °C

Cooking duration: see table

Size of potatoes	Quantity	 ⁴ ₁	 [min]
Small (40–60 g)	200 g (4)	2	15
	600 g (12)	2	18
	1000 g (20)	2	21
Medium (90–110 g)	200 g (2)	2	18
	600 g (6)	2	21
	1000 g (10)	2	24
Large (140–160 g)	300 g (2)	2	22
	600 g (4)	2	25
	900 g (6)	2	29

⁴₁ Shelf level,  Cooking duration

Cooking rice

Rice swells when cooked and needs to be cooked in liquid. The proportion of rice to liquid will vary depending on the type of rice.

The rice absorbs all the liquid during the cooking process and so none of the nutrients are lost.

- Add the rice with the liquid into a solid cooking container.

Settings





Automatic programmes  | Rice | ... | Rapid steam cooking



or

Rapid steam cooking 

Microwave power/temperature: see table

Cooking duration: see table

	Ratio Rice to liquid	To add	 4 1	 [W]	 [min]	 [°C]
Basmati rice	1:2	Salt	2	300	9	100
Parboiled rice	1:2	Salt	2	150	17	100
Pudding rice	1:3	Sugar ¹	2	150	21	100

 4
1 Shelf level,  Microwave power,  Cooking duration,  Temperature

¹ Added after the cooking process.

Microwave defrosting and reheating

We recommend using the following microwave power levels to defrost or reheat foods:

 [W]	Defrosting
80	Very delicate food: cream, butter, gateaux and filled sponge cakes, cheese
150	All other types of food
Reheating	
450	Food for babies and children
600	Various types of food; frozen ready-meals which do not need browning
850	
1000	Drinks

 Microwave power

The time required depends on the nature of the food, its initial temperature and the amount to be cooked. The durations can be found in the tables on the following pages.

Microwave defrosting and reheating

Defrost

Gentle defrosting of frozen goods means that the vitamins and minerals are generally retained.



Risk of infection from bacteria.

Bacteria such as salmonella can cause serious food poisoning.

It is particularly important to observe food hygiene rules when defrosting fish and meat, and in particular when defrosting poultry.

Do not use the liquid produced during defrosting.

Process the food as required as soon as it has been defrosted.

Tips

- Place the frozen food on the glass tray without its packaging. For larger quantities, place the food in a microwave-safe container and place this on the glass tray.
- Frozen ready meals can be defrosted and then heated at the same time. Follow the instructions on the packaging.

Defrosting frozen food

Use containers that are microwave safe.

- Place the frozen food in the middle of the glass tray on shelf level 1.
- If necessary, cover the frozen food.
- Select Defrost .
- Select Microwave and confirm with OK.
- Change the recommended power level if necessary, and confirm with OK.
- Change the defrosting time if necessary, and confirm with OK.

Start will be highlighted.

- Start the programme using the OK sensor control.
- During defrosting:
Stir, turn or rearrange the food once again. Stir the food from the outside towards the middle, as food heats more quickly from the outside.

During the standing time, the temperature is distributed evenly in the food.

- After defrosting, allow the food to stand at room temperature for a few minutes to enable the heat to spread evenly throughout the food.

Microwave defrosting and reheating

Alternative settings

Microwave 

Microwave power: see table

Defrosting time: see table

Standing time: see table

Notes in the table



Take note of the recommended microwave power levels, heating times and standing times. These take the consistency, the quantity and the initial temperature of the food into account.

Choosing durations



- You are generally advised to select the middle duration.

Microwave defrosting and reheating

Defrosting in microwave mode

Frozen food	Quantity	 [W]	 [min]	 [min]	Stir/turn/rearrange	Cover
Dairy products						
Cream	250 ml	80	14	10–15	Every 5 minutes	Yes
Butter	250 g	80	12–14	5–10	At the halfway stage	Yes
Cheese slices	250 g	80	6–7	10–15; Fan out the cheese slices	After 3 minutes	No
Milk	500 ml	150	22–23	5–10	Twice every 7 minutes	Yes
Cakes/biscuits						
Sponge cake (1 slice)	100 g	150	1–2	5–10	–	Yes
Sponge cake (1 slice)	300 g	150	3–4	10–15	At the halfway stage	Yes
Fresh fruit cake (3 slices)	3 x 100 g	150	9–10	10–15	After 5 minutes	Yes
Butter cake (3 slices)	3 x 100 g	150	5–6	10–15	At the halfway stage	Yes
Cream cake (1 slice)	100 g	80	3–4	10–15	–	Yes
Cream cake (3 slices)	3 x 100 g	80	5.5–6.5	10–15	At the halfway stage	Yes
Bread rolls (4)	4 x approx. 50 g	150	4–5	5–10	At the halfway stage	No
Fruit						
Strawberries, raspberries	150 g	80	11–12	5–10	At the halfway stage	Yes

Microwave defrosting and reheating

Frozen food	Quantity	 [W]	 [min]	 [min]	Stir/turn/rearrange	Cover
Currants	250 g	80	13–14	5–10	At the halfway stage	Yes
Plums	500 g	150	13–15	5–10	At the halfway stage	Yes
Meat						
Minced beef	500 g	150 + 80	8–9 + 17–19	10–15	Twice every 10 minutes	No
Chicken	1000 g	150	25–28	10–15	Every 10 minutes	No
Vegetables						
Peas	250 g	150	9–10	5–10	At the halfway stage	Yes
Asparagus	250 g	150	11–12	5–10	After 5 minutes	Yes
Beans	500 g	150	16–17	5–10	Twice every 5 minutes	Yes
Red cabbage (in mini portions)	500 g	150	18–19	5–10	Twice every 5 minutes	Yes
Spinach (in mini portions)	300 g	150	14–15	10–15	Twice every 5 minutes	Yes

 Microwave power level,  Defrosting time,  Standing time

Reheat

It is essential that the section entitled “Correct use” in the “Warning and safety instructions” is observed.

 Risk of injury caused by hot food.

If food for babies and children is heated at too high a temperature, they can burn themselves.

Only heat food for babies and children for 60–70 seconds at 450 W.

After heating food, especially food for babies and small children, stir the food or shake the container and taste the food so that children do not get burned.

 Risk of injury from increased pressure in closed containers or bottles.

Pressure can build up during reheating in sealed containers or bottles, causing them to explode.

Never cook or reheat food or liquids in sealed containers or bottles. Open containers beforehand. In the case of baby bottles, the screw top and teat must be removed.

Risk of injury caused by hot liquids.

When heating food, and in particular liquids, using the Micro-wave  function, the boiling point may be reached without the production of typical bubbles. The liquid does not boil evenly throughout.

This boiling delay can result in the liquid boiling over explosively. Take care when taking the container out of the oven, as the hot liquid can cause severe scalding. Under certain circumstances, the pressure can be so high that the door opens automatically.

Stir liquids well before reheating or cooking.

After reheating, wait at least 20 seconds before removing the container from the oven compartment.

In addition, a glass rod or similar item, if available, can be placed in the container during reheating.

Microwave defrosting and reheating

Tips

- Always cover food when heating it, except when heating beverages or meat/fish coated in breadcrumbs.
- Please note that foods with an initial temperature of approx. 5 °C (refrigerated temperature) need longer to heat up than those at room temperature.
- If you are in any doubt that a sufficiently high food temperature has been reached, continue heating for a little longer.
- Frozen ready meals can be defrosted and then heated at the same time. Follow the instructions on the packaging.

Heating food

Use containers that are microwave safe.

- Place the food that is to be heated in the glass tray on shelf level 1.
- If necessary, cover the food.
- Select Reheat .
- Select Microwave and confirm with *OK*.
- Change the recommended power level if necessary, and confirm with *OK*.
- Change the time if necessary, and confirm with *OK*.

Start will be highlighted.

- Start the programme using the *OK* sensor control.

- During heating:
Stir, turn or rearrange the food once again. Stir the food from the outside towards the middle, as food heats more quickly from the outside.

 Danger of burning due to hot surfaces.

The steam oven gets hot during operation. You could burn yourself on the oven compartment, side runners or accessories. Droplets of water may have accumulated underneath the crockery.

Use oven gloves when working in the hot oven compartment and when removing the crockery.

During the standing time, the temperature is distributed evenly in the food.

- After heating, allow the food to stand at room temperature for a few minutes to enable the heat to spread evenly throughout the food.

Alternative settings

Microwave 

Microwave power: see table

Duration: see table

Standing time: see table

Notes in the table



Take note of the recommended microwave power levels, heating times and standing times. These take the consistency, the quantity and the initial temperature of the food into account.

Choosing durations



- You are generally advised to select the middle duration.

Microwave defrosting and reheating

Heating in microwave mode

Food	Quantity	 [W]	 [min:s]	 [min]	Stir/turn/rearrange	Cover
Drinks¹						
Coffee, drinking temperature 60–65 °C	1 cup (200 ml)	1000	1:10–1:20	–	Before heating	No
Milk, drinking temperature 60–65 °C	1 cup/mug (200 ml)	1000	1:20–1:30	–	Before heating	No
Water, bringing to the boil	1 cup (125 ml)	1000	1:40–1:50	–	Before heating	No
Baby bottle (milk)	Approx. 200 ml	450	1:30–1:40	1	Before serving	No
Mulled wine, grog, drinking temperature 60–65 °C	1 cup/mug (200 ml)	1000	1:00–1:10	–	Before heating	No
Food²						
Baby food (room temperature)	1 jar (190 g)	450	1:00–1:10	1	Before serving	No
Cutlets, cooked	200 g	600	4:20–4:50	1	At the halfway stage	No
Fish fillet, cooked	200 g	600	3:50–4:20	1	At the halfway stage	No
Roast meat in gravy	200 g	600	4:50–5:20	1	At the halfway stage	Yes
Side dishes	250 g	600	3:40–4:10	1	At the halfway stage	Yes
Vegetables	250 g	600	3:50–4:20	1	At the halfway stage and before serving	Yes

Microwave defrosting and reheating

Food	Quantity	 [W]	 [min:s]	 [min]	Stir/turn/rearrange	Cover
Gravy	250 g	600	4:10–4:40	1	At the halfway stage and before serving	Yes
Soup/stew	250 g	600	4:00–4:30	1	At the halfway stage and before serving	Yes
	500 g	600	7:00–7:30	1	At the halfway stage and before serving	Yes

 Microwave power level,  Duration,  Standing time

- 1 A boiling delay can be avoided by stirring liquids before heating them. After heating, wait at least 20 seconds before removing the container from the oven compartment. In addition, a glass rod or similar item, if available, can be placed in the container during heating.
- 2 The times apply to food with an initial temperature of approx. 5 °C. For food not normally refrigerated, durations apply to food at room temperature of approx. 20 °C. With the exception of baby food and delicate whisked sauces, food should be heated to a temperature of 70–75 °C.

The wide range of automatic programmes enables you to achieve excellent results with ease.

Categories

The **Auto** automatic programmes are sorted into categories to provide a better overview. Simply select the appropriate programme for the type of food you are cooking and follow the instructions in the display.

Using automatic programmes

- Select Automatic programmes **Auto**.

A list will appear in the display.

- Select the desired food category (e.g. Fish).

The automatic programmes available for the category selected will then appear.

- Select the desired automatic programme.
- Follow the instructions on the display.

Usage notes

- The degree of cooking is represented by a bar with seven segments. Using the navigation area you can set the desired degree of cooking.
- The weights specified in the automatic programmes refer to the weight per piece. For example, you can cook just one piece of salmon weighing 250 g or 10 pieces of salmon, each weighing 250 g, at the same time.
- The steam oven compartment needs to cool to room temperature before starting an automatic programme.
- When you place food into the hot oven compartment, be careful when opening the door. Hot steam may escape. Step back and wait until the steam has dissipated. Avoid contact with hot steam, and do not touch the hot oven compartment walls. Danger of burning and scalding.
- For some automatic programmes, the start time can be delayed using **Start at** or **Finish at**.
- Select the **↵** sensor control to cancel an automatic programme. When **Cancel process?** appears, select **Yes** and confirm with **OK**.
- If by the end of an automatic programme the food is not cooked enough for your taste, select **Cont. cooking**.
- Automatic programmes can also be saved as **User programmes**. To do this, select the **↵** sensor control after an automatic programme has finished.

User programmes

You can create and save up to 20 of your own programmes.

- You can combine up to 9 cooking stages to accurately programme your favourite or most frequently used recipes. In each cooking stage, you can select settings such as the function, temperature and cooking duration.
- You can enter the name of the programme for your recipe.

When you call up and start your programme again, it will run automatically.

There are different ways of creating a user programme:

- At the end of an automatic programme or special application, save it as a user programme.
- Save a cooking programme after running it with a set cooking duration.

Then enter a programme name.

Creating user programmes

- Select **User programmes** .
- Select **Create programme**.

You can now specify the settings for the first cooking stage.

Follow the instructions in the display:

- Select and confirm the desired settings.
- Select **Finish cooking stage**.

All settings for the first cooking stage have now been set.

You can add more cooking stages, for example, if you want to add another cooking function to follow on from the first.

- If additional cooking stages are required, select **Add cooking stage** and proceed as per the 1st cooking stage.

If you want to check the settings or to change them at a later date, select the cooking stage in question.

- When you have finished setting all the cooking stages, select **Save**.
- Enter the programme name.
- Select **✓**.

A message will appear in the display confirming that the programme name has been saved.

- Confirm with **OK**.

You can start the saved programme immediately, delay the start or change the cooking stages.

Starting user programmes

- Place the food in the oven compartment.
- Select User programmes .
- Select the desired programme.
- Select Allow.

Depending on the programme settings, the following menu options appear in the display:

- Start now
The programme will start immediately. The oven heating will switch on immediately.
 - Finish at
Specify the time when you want the programme to stop. The oven heating will switch off automatically at the time you have set.
 - Start at
Specify the time when you want the programme to start. The oven heating will switch on automatically at the time you have set.
 - Show cooking stages
A summary of your settings will appear on the display.
- Select the desired menu option.

The programme selected will begin straight away or at the time set.

- At the end of the programme, select the  sensor control.

Changing cooking stages

Cooking stages in automatic programmes that have been saved under a different name cannot be changed.

- Select User programmes .
- Select the programme you want to change.
- Select Change programme.
- Select the cooking stage that you want to change or Add cooking stage to add another cooking stage.
- Select and confirm the desired settings.
- If you want to start the modified programme without changing it, select Start programme.
- Select Save when you have changed all the settings.



A message will appear in the display confirming that the programme name has been saved.

- Confirm with OK.

The saved programme has been changed and you can start it immediately or delay the start.

User programmes

Changing the name

- Select User programmes .
- Select the programme you want to change.
- Select Change name.
- Change the programme name.
- Select .

A message will appear in the display confirming that the programme name has been saved.



- Confirm with *OK*.

The programme has been renamed.



Deleting user programmes

- Select User programmes .
- Select the programme you want to delete.
- Select Delete programme.
- Confirm the request with *Yes*.

The programme is deleted.

Go to Further  | Settings  | Factory default | User programmes **to delete all user programmes at the same time.**



Test food in accordance with EN 60350-1 (steam cooking function)

Test food	Cooking container(s)	Quantity [g]	 ⁴	 ² [°C]	 [min]
Steam replenishment					
Broccoli (8.1)	1x DGGL 1/2-40L	300	Any	100	3
Steam distribution					
Broccoli (8.2)	2x DGGL 1/2-40L	max.	Any ³	100	3
Appliance capacity					
Peas (8.3)	4x DGGL 1/2-40L	875 in each	2, 4 ⁴	100	5

⁴ Shelf level(s), ² Temperature,  Cooking duration

- Place the glass tray or condensate tray (depending on the model) in shelf level 1.
- Place the test food in a cold oven compartment (before the heating-up phase begins).
- Place 2x DGGL 1/2-40L containers adjacent to one another in the shelf level.
- Place 2x DGGL 1/2-40L containers adjacent to one another in each of the shelf levels.
- The test is finished when the temperature measures 85 °C in the coolest place.

Menu cooking test food¹ (steam cooking function)





Test food	Cooking containers	Quantity [g]	 ²	 [°C]	Height [cm]	 [min]
Potatoes, waxy, quartered ³	1 x 1/2 DGGL-40 L	800	4	100	–	17
Salmon fillet, frozen, not defrosted	1 x 1/2 DGGL-40 L	4 x 150	2	100	< 2.5 ≥ 2.5 ≤ 3.2 > 3.2	9 10 11
Broccoli florets	1 x 1/2 DGGL-40 L	600	3	100	–	4





⁴ Shelf level, ² Temperature,  Cooking duration

- For instructions, see “Steam cooking – Menu cooking”.
- Place the glass tray or condensate tray (depending on the model) on shelf level 1.
- Place the 1st test food item (potatoes) in the cold oven compartment (before the heating-up phase begins).

Note for test institutes





Test food in accordance with EN 60705 (rapid steam cooking function ¹⁾)

Test food	 ²	 [W]	 ³ [°C]	 [min]	 ⁴ [min]	Notes
Custard, 1000 g (12.3.1)	1	150	80	19–20	120	Container: see description in 12.3.1.2 and Appendix B, dimensions at upper rim 250 x 250 mm, cook uncovered
Sponge cake, 475 g (12.3.2)	1	300	85	7	5	Container: see description in 12.3.2.2 and Appendix B, external diameter at the upper rim 220 mm, cook uncovered

⁴ Shelf level,  Microwave power, ³ Temperature,  Defrosting or cooking duration,  Standing time

- 1 Function combining steam cooking and microwave power.
- 2 Use the glass tray as a surface to place containers on.
- 3 Place the test food in a cold oven compartment (before the heating-up phase begins).
- 4 Allow the test food to stand at room temperature. This allows the heat to spread evenly throughout the food and so that a consistent temperature is reached.

Test food in accordance with EN 60705 (microwave function)

Test food	 ¹	 [W]	 [min]	 ² [min]	Notes
Custard, 1000 g (12.3.1)	1	450	19–20	120	Container: see description in 12.3.1.2 and Appendix B, dimensions at upper rim 250 x 250 mm, cook uncovered
Sponge cake, 475 g (12.3.2)	1	450 + 300	4 + 10–10:30	5	Container: see description in 12.3.2.2 and Appendix B, external diameter at the upper rim 220 mm, cook uncovered
Mince, 900 g (12.3.3)	1	600 + 450	8 + 18–19	5	Container: see description in 12.3.3.2 and Appendix B, dimensions at the upper rim 250 x 124 mm, cook uncovered, place dish crosswise in the cooking compartment
Defrost mince (beef), 500 g (13.3)	1	150 + 80	8 + 8–9	10	Container: see description in 13.3.2 and Appendix B, defrost uncovered, turn halfway through the duration
Raspberries, 250 g (A.3.2)	1	80	12–13	3	Container: see description in A.3.2.2, defrost uncovered

¹ Shelf level,  Microwave power,  Defrosting or cooking duration, ² Standing time

- 1 Use the glass tray as a surface to place containers on.
- 2 Allow the test food to stand at room temperature. This allows the heat to spread evenly throughout the food and so that a consistent temperature is reached.

Cleaning and care

 Risk of injury caused by hot surfaces.

The steam oven gets hot during operation. You could burn yourself on the oven compartment, side runners or accessories.

Allow the oven compartment, side runners and accessories to cool before cleaning.

 Risk of injury due to electric shock.

The steam from a steam cleaning appliance could reach live electrical components and cause a short circuit.

Never use a steam cleaner for cleaning.

All surfaces could be discoloured or damaged if unsuitable cleaning agents are used.

All surfaces are susceptible to scratching. Scratches on glass can in some circumstances lead to breakage.

Use only domestic washing-up liquid to clean the appliance.

Remove all cleaning agent residues immediately.

Do not use cleaning agents or washing-up liquids containing aliphatic hydrocarbons as these could cause the seals to swell.

Stubborn soiling could damage the steam oven in certain circumstances.

Once the oven has cooled, clean the oven compartment, the inside of the door and the door seal. Waiting too long can make cleaning unnecessarily difficult and in some cases impossible.

Operating a damaged steam oven can result in microwave leakage and present a hazard to the user.

Check the door and door seal for any sign of damage. If any damage is noticed, the oven should not be used again with microwave functions until the fault has been rectified by a service technician.

- The appliance and accessories should be cleaned and dried thoroughly after each use.
- Leave the appliance door open until the oven compartment is completely dry.

Tip: If the appliance is not going to be used for a longer period of time – during a holiday, for example – it should be thoroughly cleaned and dried beforehand to prevent the build-up of odours and so on. Leave the door open afterwards.

Unsuitable cleaning agents

To avoid damaging the surfaces of your appliance, do not use:

- Cleaning agents containing soda, ammonia, acids or chlorides
- Cleaning agents containing descaling agents
- Abrasive cleaning agents, e.g. powder cleaners and cream cleaners
- Solvent-based cleaning agents
- Stainless steel cleaning agents
- Dishwasher cleaner
- Glass cleaning agents
- Cleaning agents for ceramic glass hobs
- Hard, abrasive brushes or sponges (e.g. pot scourers, brushes or sponges which have been previously used with abrasive cleaning agents)
- Melamine eraser blocks
- Sharp metal scrapers
- Wire wool
- Stainless steel spiral pads
- Spot cleaning with mechanical cleaning agents
- Oven cleaners or sprays

Cleaning the steam oven front

- Clean the appliance front with a clean, soft sponge and a solution of warm water and washing-up liquid.
- After cleaning, wipe the surfaces dry using a soft cloth.

Tip: A clean, damp microfibre cloth without cleaning agent can also be used.

Cleaning and care

Cleaning the oven compartment

The oven compartment, the door seal, the inside of the door and the drip channel should be cleaned and dried after each use.

- Remove:
 - Condensate using a sponge or absorbent cloth
 - Light, greasy soiling with a clean sponge and a solution of washing-up liquid and hot water
- After cleaning, wipe the surface with clean water to remove any cleaning agent residues.
- Then wipe the surfaces dry using a cloth.

Cleaning the automatic door opener

Ensure that the door opener does not become soiled with food residues.

- Wipe away soiling **immediately** with a clean sponge and a solution of washing-up liquid and hot water.
- After cleaning, wipe the surface with clean water to remove any cleaning agent residues.

Cleaning the water container

- Take out the water container after each use involving steam.
- Remove the spill guard.
- Empty the water container.
- Rinse the water container by hand and then dry it to prevent limescale.
- Fit the spill guard back into the water container. Make sure the spill guard engages correctly.

Accessories

All accessories are dishwasher safe.

Cleaning the glass tray, rack and cooking containers

- Wash and dry the glass tray, rack and cooking containers after each use.
- Any bluish discolouration on the cooking containers can be removed with vinegar. Then rinse with clean water.

Cleaning the side runners

The side runners are suitable for cleaning in a dishwasher.

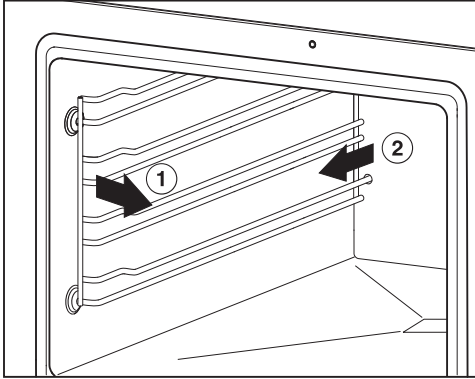

- Pull the side runners out of holder (1.) from the front and remove them (2.).
- The side runners can be washed in the dishwasher or by hand with a solution of warm water and a little washing-up liquid applied with a clean sponge or cloth.

Reassemble by following these instructions in reverse order.

- Refit the side runners carefully.

If the side runners are not correctly inserted, there is no anti-tip protection.

The side runners are fitted in plastic bushings. Check the bushings for damage.

If the bushings are damaged, do not use any functions involving microwave power until the bushings have been replaced.

Maintenance

The **Finish at** and **Start at** functions are not available with maintenance programmes.

Descaling the steam oven

We recommend using Miele descaling tablets (see “Optional accessories”) to descale the appliance. These have been specially developed for use with Miele appliances to optimise the descaling process. Other descaling agents, which contain other acids besides citric acid and/or other undesirable substances, such as chlorides for example, could cause damage to the product. Moreover, the descaling result required could not be guaranteed if the descaling solution was not of the appropriate concentration.

Do not spill descaling agent onto metal surfaces. This can cause marks to appear.

However, should any descaling agent get onto these surfaces, wipe it away immediately.

The steam oven has to be descaled after a certain number of operating hours. When the time comes to descale it, the number of uses remaining lights up in the display. It only counts the number of uses that use steam. The steam oven will be disabled after the last remaining cooking process.

We recommend that you descale the appliance before it locks out.

Cleaning and care

During the descaling process, the water container must be rinsed out and re-filled with fresh water.

- Switch the steam oven on and select Further  | Maintenance | Descale.

The message **Please wait** will appear on the display. The descaling process is being prepared. This may take several minutes. As soon as the appliance is ready you will be prompted to fill the water container.

- Fill the water container with lukewarm fresh tap water up to the level marker  and drop 2 Miele descaling tablets in it.
- Wait until the descaling tablets have dissolved.
- Push the water container into the appliance.
- Confirm with *OK*.

The time left appears on the display. The descaling process will now begin.

Do not switch the steam oven off during the descaling process, otherwise the whole process will have to be started from the beginning again.

The water container will need emptying and refilling with fresh tap water twice during descaling.

- Follow the instructions on the display.
- Confirm each with *OK*.

Once the time left has elapsed, **Finished** appears on the display and a buzzer sounds.

- Switch the steam oven off.
- Remove the water container and take out the spill guard.
- Empty and dry the water container.
- Allow the oven compartment to cool down.
- Then dry the oven compartment.
- Leave the appliance door open until the oven compartment is completely dry.

Soak

Stubborn soiling can be soaked using this maintenance programme.

- Allow the oven compartment to cool down.
- Remove all accessories from the oven.
- Remove coarse soiling with a cloth.
- Select Further  | Maintenance | Soak.

The soaking process takes approx. 10 minutes.

Problem solving guide

Many malfunctions and faults that can occur in daily operation can be easily remedied. Time and money will be saved because a service call will not be needed.



The following guide may help you to find the reason for a malfunction or a fault, and to correct it.

Problem	Cause and remedy
You cannot switch the appliance on.	The fuse has tripped. ■ Reset the trip switch in the fuse box or replace the fuse in the plug (see data plate for minimum fuse rating).
	There may be a technical fault. ■ Disconnect the appliance from the mains connection for approximately 1 minute by: – Tripping the relevant mains fuse or unscrewing the fuse completely, or – Switching off the residual current protection device ■ If, after resetting the trip switch in the mains fuse box or the residual current protection device, the steam oven will still not turn on, contact a qualified electrician or Miele Service.
The oven compartment does not heat up.	Demo mode is active. The steam oven can be operated, however, the heating elements will not work. ■ Deactivate demo mode (see “Settings – Show-room programme”).
	The oven compartment has been warmed up by a warming drawer in operation underneath it. ■ Open the door and let the oven compartment cool down.



Problem solving guide

Problem	Cause and remedy
<p>The sensor controls do not respond.</p>	<p>You have selected the Display QuickTouch Off setting. So when the steam oven is switched off, the sensor controls do not respond.</p> <ul style="list-style-type: none"> ■ As soon as the steam oven is switched on, the sensor controls will respond. If you want the sensor controls to always respond even when the steam oven is switched off, select the Display QuickTouch On setting. <p>The steam oven is not connected to the power supply.</p> <ul style="list-style-type: none"> ■ Check that the steam oven plug is correctly inserted into the socket. ■ Check whether the fuse has tripped. Contact a qualified electrician or the Miele Customer Service Department. <p>There is a fault with the controls.</p> <ul style="list-style-type: none"> ■ Touch and hold the  On/Off sensor control until the display switches off and the steam oven restarts.
<p>The fan can still be heard after the appliance has been switched off.</p>	<p>The fan is still running. The appliance is fitted with a fan which removes steam from the oven. The fan will continue to run for a while after the appliance has been switched off. It will switch itself off automatically after a while.</p>
<p>A humming sound can be heard after switching on the appliance, during operation and after switching off the appliance.</p>	<p>It is quite normal and does not indicate any fault with the appliance. It happens when water is being pumped through the system.</p>
<p>After moving house, the steam oven no longer switches from the heating-up phase to the cooking phase.</p>	<p>The boiling temperature of the water has changed as the altitude of the new location for the appliance differs from the old one by at least 300 m.</p> <ul style="list-style-type: none"> ■ To adjust the boiling temperature, you need to descale the steam oven (see “Cleaning and care – Descaling the steam oven”).

Problem solving guide

Problem	Cause and remedy
<p>During operation an unusually large amount of steam escapes, or steam escapes from parts of the oven where it does not usually.</p>	<p>The door is not properly closed.</p> <ul style="list-style-type: none"> ■ Close the door.
	<p>The door seal is not correctly fitted.</p> <ul style="list-style-type: none"> ■ Press it in all the way round the door to make sure it is fitted evenly.
	<p>The door seal is damaged, e.g. cracks can be seen.</p> <p>The door seal needs to be replaced.</p> <ul style="list-style-type: none"> ■ Call Miele Service. ■ Do not use any microwave modes / functions until the door seal has been replaced.
<p>A whistling sound is heard when the appliance is switched on again.</p>	<p>When the door is closed, the pressure has to equalise, which can cause a whistling sound. This is not a fault.</p>
<p>The <small>Start at</small> and <small>Finish at</small> functions are not available.</p>	<p>The temperature in the oven compartment is too high, e.g. after a programme has finished.</p> <ul style="list-style-type: none"> ■ Open the door and let the oven compartment cool down.
	<p>These functions are not generally available in maintenance programmes.</p>
<p>After long cooking programmes using microwave power , the oven interior is very damp.</p>	<p>The steam oven with microwave is a fully fledged steam oven. The cooking compartment is completely hermetically sealed. In contrast, a conventional microwave oven is not air-tight. Because the cooking compartment is steam-tight, condensation will form on the side walls and the inner door panel during long cooking programmes using microwave power . The amount of condensate depends on the cooking duration and the level of moisture in the food.</p>

Problem solving guide

Problem	Cause and remedy
<p>The food is not sufficiently heated or is not cooked at the end of a set duration when using the  microwave function.</p>	<p>The microwave oven was not restarted after interrupting a cooking programme.</p> <ul style="list-style-type: none"> ■ Restart the cooking programme to ensure the food is heated or cooked properly. <p>When cooking or heating with microwave power, the duration set was too short.</p> <ul style="list-style-type: none"> ■ Check that the correct duration is selected for the microwave power level. The lower the microwave power level the longer the cooking duration. <p>With a very small amount of food, the steam oven automatically reduces the power level to suit the actual amount of food as a safety precaution. The display still shows the previously set initial power level.</p> <ul style="list-style-type: none"> ■ Restart the programme with a lower microwave power setting to ensure the food is heated or cooked properly.
<p>Food has cooled down too quickly after being heated or cooked using the microwave function .</p>	<p>In the microwave oven, food begins to cook from the outside first, the inside of the food relying on the slower conduction of heat. If food is cooked at a high microwave power level, it is possible that the heat may not have reached the centre of the food, so it is hot on the outside but cold in the centre. During the standing time, the heat is transferred to the centre of the food.</p> <ul style="list-style-type: none"> ■ When heating food with different densities, such as with menu cooking, it is sensible to start with a low microwave power level and select a longer reheating duration.
<p>Less than half of the popcorn has popped when using the popcorn function .</p>	<p>The oven compartment was too warm and/or too humid.</p> <ul style="list-style-type: none"> ■ Allow the oven compartment to cool and/or dry it with a towel. <p>The cooking duration was too short.</p> <ul style="list-style-type: none"> ■ Change the predefined time. The maximum cooking duration that can be set is 4 minutes (see “Settings – Popcorn”).
<p>The oven interior lighting is not working.</p>	<p>The lamp is defective.</p> <ul style="list-style-type: none"> ■ Call Miele Service to have the lamp replaced.

Problem solving guide

Problem	Cause and remedy
F44	Communication fault <ul style="list-style-type: none"><li data-bbox="400 236 1046 293">■ Switch the steam oven off and then back on again after a few minutes.<li data-bbox="400 300 1046 357">■ If the same message appears again, call the Service Department.
F and other fault codes	Technical fault. <ul style="list-style-type: none"><li data-bbox="400 411 949 440">■ Switch the appliance off and contact Miele.

Optional accessories

Miele offer a comprehensive range of useful accessories as well as cleaning and conditioning products for your Miele appliances.

These products can be ordered through the Miele Webshop.

They can also be ordered from Miele (see end of this booklet for contact details) or from your Miele dealer.

Containers

Miele offers a wide range of cooking containers. These have all been optimised in terms of functionality and dimensions for Miele appliances. Detailed information on each of our products can be found on the Miele website.

The cooking containers provided and the rack are **not** suitable for use with the Microwave  function.

- Perforated cooking containers in various sizes
- Solid cooking containers in various sizes

Cleaning and care products

- Descaling tablets (6)
- All-purpose microfibre cloth for removing finger marks and light soiling

Miscellaneous

The rack is **not** suitable for use with the Microwave  function.

- Rack
- Glass tray

Contact in the event of a fault

In the event of any faults which you cannot remedy yourself, please contact your Miele dealer or the Miele Customer Service Department.

You can book a Miele Customer Service Department call-out online at www.miele.com/service.

Contact information for the Miele Customer Service Department can be found at the end of this document.

Please quote the model identifier and serial number of your appliance (Fabr./SN/Nr.) when contacting the Miele Customer Service Department. This information can be found on the data plate.

Please note that telephone calls may be monitored and recorded for training purposes and that a call-out charge will be applied to service visits where the problem could have been resolved as described in this booklet.

This information is given on the data plate, which is visible on the front frame of the oven when the door is fully open.

Warranty

For information on the appliance warranty specific to your country please contact Miele. See back cover for address.

In the UK, your appliance warranty is valid for 2 years from the date of purchase. However, you must activate your cover by calling 0330 160 6640 or registering online at www.miele.co.uk.

Installation

Safety instructions for installation

 Risk of damage from incorrect installation.

Incorrect installation can cause damage to the steam oven.

The steam oven must only be installed by a qualified person.

▶ The connection data (frequency and voltage) on the steam oven's data plate absolutely must correspond with those of the electricity supply in order to ensure that no damage can occur to the steam oven.

Compare this data before connecting the appliance. If in any doubt, consult a qualified electrician.

▶ Multi-socket adapters and extension leads do not guarantee the required safety of the appliance (fire hazard). Do not use them to connect the steam oven to the power supply.

▶ The socket should be easily accessible after the steam oven has been installed.

▶ The steam oven must be positioned so that you can see the contents of a cooking container placed on the top shelf level. Otherwise there is a risk of injuries or spillages of hot food.

Building-in dimensions

All dimensions are given in mm.

Installation in a tall unit

The furniture housing unit must not have a back panel fitted behind the building-in niche.

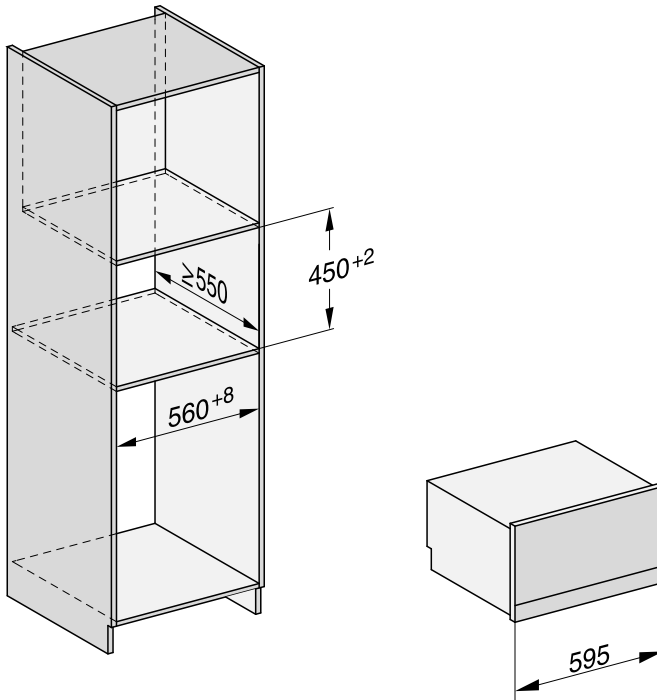

Installation

Installation in a base unit

The furniture housing unit must not have a back panel fitted behind the building-in niche.

When building the steam oven into a base unit underneath an electric or induction hob, please also observe the installation instructions for the hob as well as the building-in depth required for the hob.

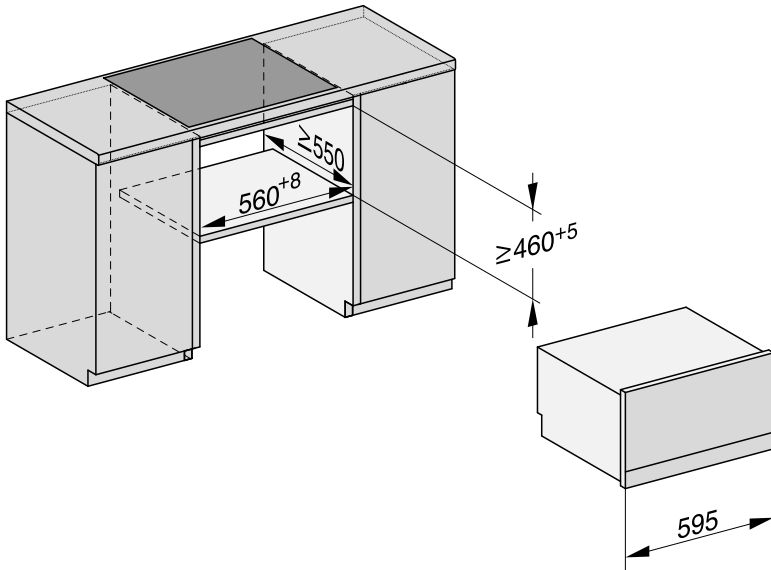

Side view

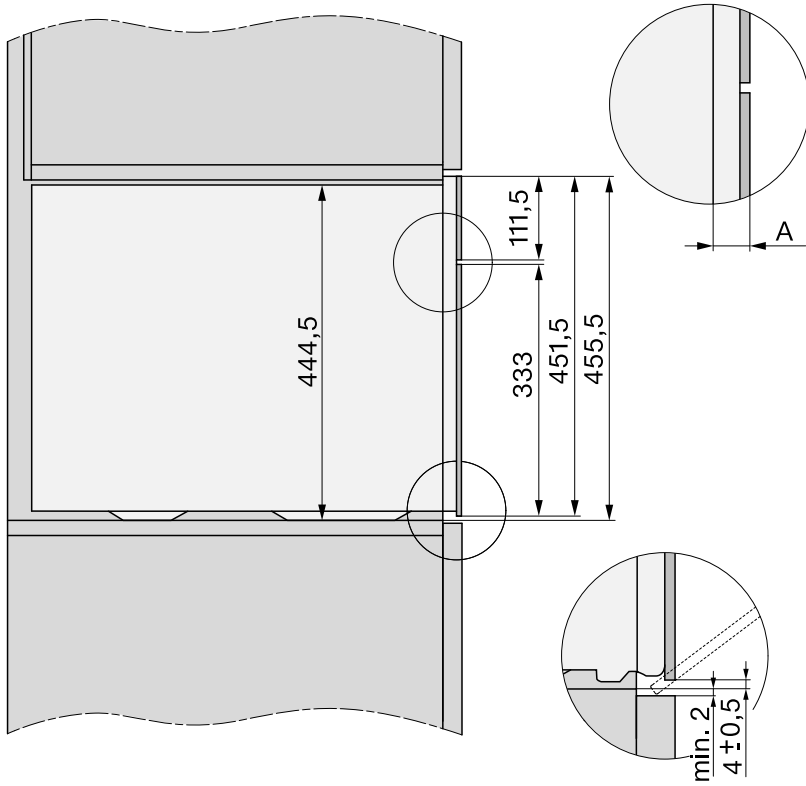

- A** Glass front: 22 mm
- Metal front: 23.3 mm

Installation

Connection and ventilation

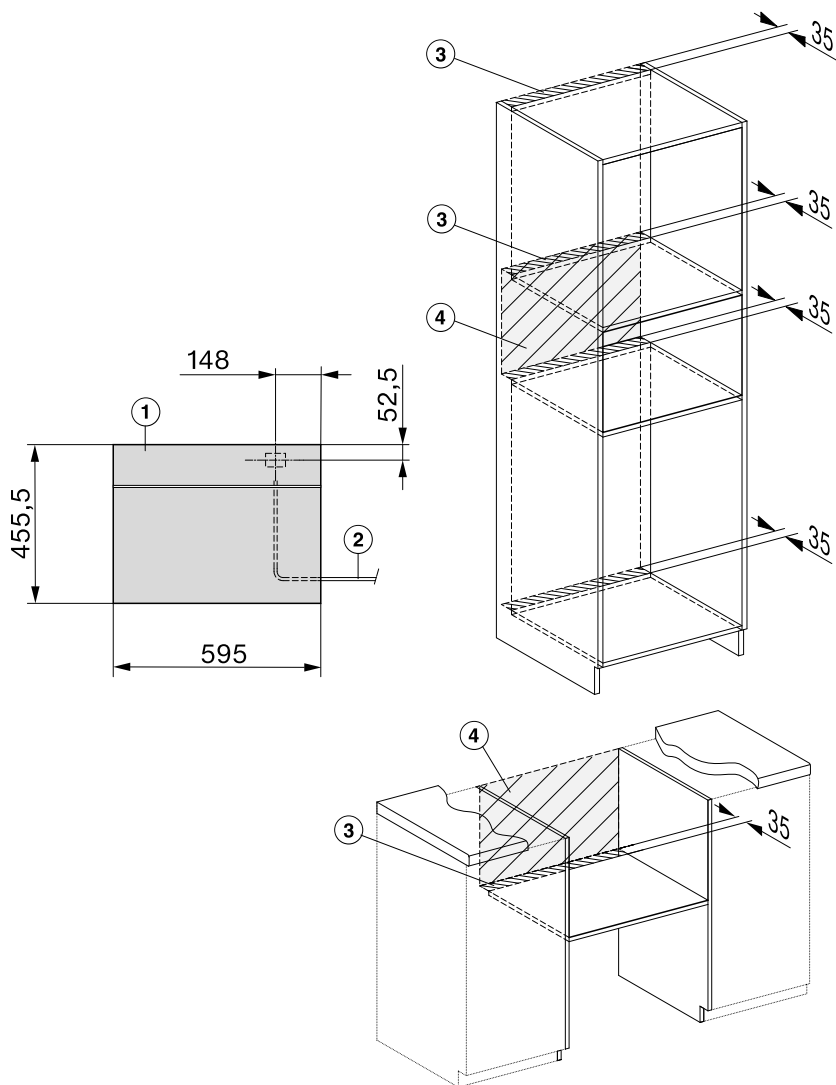

① Front view

② Mains connection cable, L = 2000 mm

③ Ventilation cut-out, min. 180 cm²

④ No connections permitted in this area

Installing the steam oven

- Connect the mains cable to the steam oven.

Risk of damage from incorrect transportation.

Lifting the steam oven by the door handle could cause damage to the door.

Use the handle cut-outs on the side of the casing to lift the appliance.

The steam generator may malfunction if the steam oven is not on a level surface.

The maximum deviation from the horizontal that can be tolerated is 2°.

- Push the steam oven into the housing unit and align it.
When doing so make sure that the power cable does not get trapped or damaged.
- Open the door.

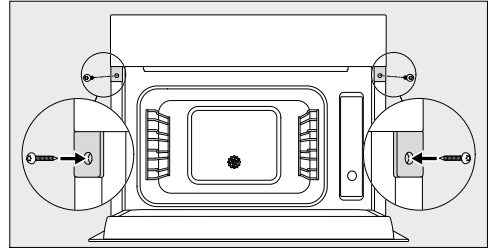

- Secure the steam oven to the side walls of the unit using the wood screws supplied (3.5 x 25 mm).
- Connect the steam oven to the electricity supply.
- Check all functions of the steam oven are working correctly in accordance with the operating instructions.

Installation

Electrical connection

We recommend that you connect the steam oven to the power supply using a suitable switched electrical socket. This makes it easier to perform servicing work. The socket must be easily accessible after the steam oven has been installed.



Risk of damage from incorrect connection.

Installation, repairs and other maintenance work by unqualified persons could be dangerous. Miele cannot be held liable for unauthorised work.

Miele cannot be held liable for damage or injury caused by the lack of or inadequacy of an on-site earthing system (e.g. electric shock).

If the plug is removed from the connection cable or if the cable is supplied without a plug, the steam oven must be connected to the electrical supply by a suitably qualified electrician.

If the socket is no longer accessible, or if a hard-wired connection is installed, an additional means of disconnection must be provided for all poles. A suitable means of disconnection would include switches with an all-pole contact gap of at least 3 mm. These include circuit breakers, fuses and contactors. The required connection data is provided on the data plate. Please ensure that these details match the electrical supply.

After installation, ensure that all electrical components are shielded and cannot be accessed by users.

Total power rating

See data plate

Connection data

The connection data is quoted on the data plate. Please ensure these match the household mains supply.

Residual current device

For extra safety, it is advisable to protect the steam oven with a suitable residual current device (RCD) with a trip range of 30 mA.

Replacing the mains connection cable

When replacing the mains connection cable, please use cable type H 05 VV-F with a suitable cross-section. These cables are available from the manufacturer or from Miele Service.

Disconnecting from the mains

 Risk of electric shock from mains voltage.

There is a risk of electric shock if the appliance is reconnected to the mains supply during repair or service work.

After disconnection, ensure the appliance cannot be switched back on by mistake.

To disconnect the appliance from the mains power supply, do one of the following depending on installation:

Safety fuses

- Completely remove the fuse links from the screw caps.

Automatic circuit breakers

- Press the test button (red) until the middle button (black) springs out.

Built-in circuit breakers

- For circuit breakers of at least type B or C, switch the lever from 1 (on) to 0 (off).

Residual current device (RCD)

- Residual current device: switch the main switch from 1 (on) to 0 (off) or press the test button.

Conformity declaration

Miele hereby declares that this steam oven with microwave complies with Directive 2014/53/EU.

The complete text of the EU declaration of conformity is available from one of the following internet addresses:

- Products, Download from www.miele.co.uk
- For service, information, operating instructions etc: go to www.miele.co.uk/domestic/customer-information-385.htm and enter the name of the product or the serial number

Frequency band of the WiFi module	2,4000 GHz – 2,4835 GHz
-----------------------------------	-------------------------

Maximum transmission power of the WiFi module	< 100 mW
---	----------

United Kingdom

Miele Co. Ltd., Fairacres, Marcham Road, Abingdon, Oxon, OX14 1TW

Tel: 0330 160 6600, Internet: www.miele.co.uk/service, E-mail: info@miele.co.uk

Australia

Miele Australia Pty. Ltd.
ACN 005 635 398
ABN 96 005 635 398
1 Gilbert Park Drive
Knoxfield, VIC 3180
Tel: 1300 464 353
Internet: www.miele.com.au

China Mainland

Miele Electrical Appliances Co., Ltd.
1-3 Floor, No. 82 Shi Men Yi Road
Jing' an District
200040 Shanghai, PRC
Tel: +86 21 6157 3500
Fax: +86 21 6157 3511
E-mail: info@miele.cn,
Internet: www.miele.cn

Hong Kong, China

Miele (Hong Kong) Ltd.
41/F - 4101, Manhattan Place
23 Wang Tai Road
Kowloon Bay, Hong Kong
Tel: (852) 2610 1025
Fax: (852) 3579 1404
Email:
customerservices@miele.com.hk
Website: www.miele.hk

India

Miele India Pvt. Ltd.
Ground Floor, Copia Corporate Suites
Plot No. 9, Jasola
New Delhi - 110025
Tel: 011-46 900 000
Fax: 011-46 900 001
E-mail: customercare@miele.in
Internet: www.miele.in

Ireland

Miele Ireland Ltd.
2024 Bianconi Avenue
Citywest Business Campus
Dublin 24
Tel: (01) 461 07 10
Fax: (01) 461 07 97
E-Mail: info@miele.ie
Internet: www.miele.ie

Malaysia

Miele Sdn Bhd
Suite 12-2, Level 12
Menara Sapura Kencana
Petroleum
Solaris Dutamas No. 1
Jalan Dutamas 1
50480 Kuala Lumpur, Malaysia
Phone: +603-6209-0288
Fax: +603-6205-3768

New Zealand

Miele New Zealand Limited
IRD 98 463 631
8 College Hill
Freemans Bay, Auckland 1011
New Zealand
Tel: 0800 464 353
Internet: www.miele.co.nz

Singapore

Miele Pte. Ltd.
29 Media Circle
#11-04 ALICE@Mediapolis
Singapore 138565
sTel: +65 6735 1191
Fax: +65 6735 1161
E-Mail: info@miele.com.sg
Internet: www.miele.sg

South Africa

Miele (Pty) Ltd.
63 Peter Place
Bryanston 2194
P.O. Box 69434
Bryanston 2021
Tel: (011) 875 9000
Fax: (011) 875 9035
E-mail: info@miele.co.za
Internet: www.miele.co.za

Thailand

Miele Appliances Ltd.
BHIRAJ TOWER at EmQuartier
43rd Floor Unit 4301-4303
689 Sukhumvit Road
North Klongton Sub-District
Vadhana District
Bangkok 10110, Thailand

United Arab Emirates

Miele Appliances Ltd.
Showroom 1
Eiffel 1 Building
Sheikh Zayed Road, Umm Al Sheif
P.O. Box 114782 - Dubai
Tel. +971 4 3044 999
Fax. +971 4 3418 852
800-MIELE (64353)
E-Mail: info@miele.ae
Website: www.miele.ae

Manufacturer: Miele & Cie. KG, Carl-Miele-Straße 29, 33332 Gütersloh, Germany

DGM 7340, DGM 7440

en-GB

M.-Nr. 11 276 070 / 02