

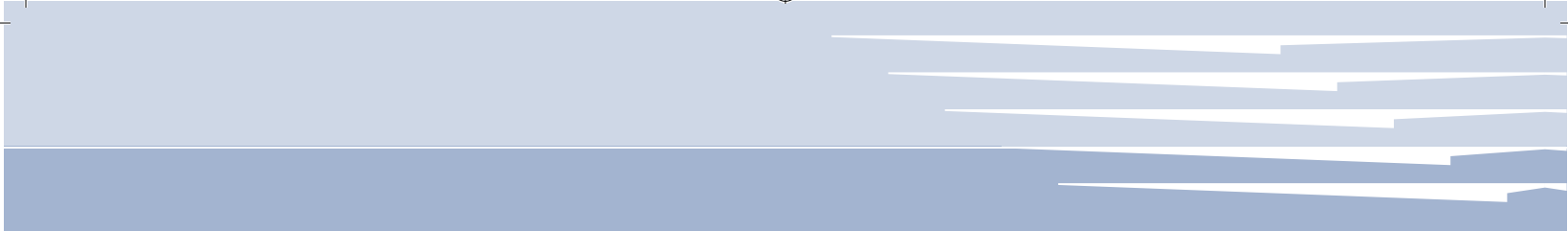

USER MANUAL

***Fhiaba***



Page 2	<b>1 Important directions for safety and the environment</b>
	1.1 For your safety
	1.2 Caring for the environment
	1.3 Cleaning, sanitization and maintenance of the ice and/or water dispenser (if present)
4	<b>2 Installation</b>
	2.1 Installation
	2.2 Connection to the electrical power supply
	2.3 Connection to the water system
6	<b>3 Before starting</b>
	3.1 Know your appliance
	3.2 Main features
	3.3 Main components
	3.4 Electronic Control
	3.5 Main control panel
	3.6 Fresco control panel
10	<b>4 Appliance switching on and off</b>
	4.1 Switching on and off
	4.2 How to adjust the temperature for different requirements
	4.3 Ice Maker activation
	4.4 Information and malfunction messages on the display
12	<b>5 Settings and Special Functions</b>
	5.1 Customization and language settings
	5.2 Special functions activated through the Menu
	5.3 Basic settings of the Menu
17	<b>6 Internal Layout</b>
	6.1 Internal Layout (positioning, adjustment, removal)
19	<b>7 Activation and use of the Ice Maker</b>
	7.1 Activation and use of the Ice Maker
	7.2 Water Filter
21	<b>8 Lighting</b>
	8.1 Lighting
22	<b>9 Food Preservation</b>
	9.1 General directions
	9.2 TriMode compartment
	9.3 How to maintain good food quality
	9.4 Recommendations for preserving fresh food
	9.5 Recommendations for preserving frozen food
26	<b>10 Recommended times for Food Preservation</b>
27	<b>11 Care and Cleaning</b>
	11.1 Care and Cleaning
	11.2 Condenser cleaning
	11.3 Internal cleaning
28	<b>12 Troubleshooting Guide</b>
	12.1 Troubleshooting Guide
	12.2 Malfunction messages appearing on the display
30	<b>13 Before calling for service</b>
	13.1 Before calling for service
31	<b>14 Menu Map</b>
	14.1 Functions
	14.2 Setting

# 1 Important directions for safety and the environment

## 1.1 For your safety



### Notes

Recommendations for correct use of the appliance



### Important

Directions for avoiding appliance damage



### Warning

Indications for avoiding injury to people

- If this appliance is replacing an existing appliance which must be removed or disposed of, make sure that it does not become a dangerous trap for children by cutting its power supply cable and rendering it impossible to close the door. Use the same caution at the end of the lifespan of the new appliance.

- This appliance is designed to refrigerate beverages and foods and is intended for domestic use.

- The appliance must be installed by following the instructions in the Installation Guide, particular care should be taken not to obstruct the vent openings of the appliance and of the built-in units.

- The appliance features a concentrated lighting system with LED lamps. Do not stare into these lamps when they are on to avoid possible eyesight damage. This warning is also contained on the label attached to the inside of the refrigerator door.

- When the freezer is functioning do not touch the inner surfaces in stainless steel with wet or damp hands, since skin may stick to the very cold surfaces.

- Do not use any type of electrical equipment inside of the food conservation compartments.

- When positioning the shelves, do not place fingers in the shelf slide guides.

- Do not position containers of flammable liquids near the appliance.

- Completely switch off the appliance and unplug the power supply cable during cleaning operations. If the plug is not easily reached, it is a good idea to turn off the breaker or remove the fuse that controls the socket that the appliance is connected to.

- The packaging parts can be dangerous for children: do not allow children to play with the plastic bags, plastic film or Styrofoam.

- Any repairs must be performed by a qualified Fhiaba Service technician.

- This appliance is not intended for use by persons (including children) with reduced physical, sensory or lack of experience and knowledge unless they have been given supervision or instruction concerning use of the appliance by a person responsible for their safety. Children should be supervised to ensure that they do not play with the appliance.

- Do not damage the appliance refrigerant circuit pipes.

- Do not store explosive substances such as aerosol cans with a flammable propellant in this appliance.

# Important directions for safety and the environment 1

## Caring for the environment 1.2



- Pay special attention to correct disposal procedure for all the packaging materials.
- The appliance must not be disposed of with urban waste. Contact local waste disposal centers for on how to dispose of recyclable waste.
- Prior to disposal, cut the power supply cord and make it impossible to close the door.
- During disposal, avoid damage to the refrigeration circuit.
- The appliance does not contain hazardous substances for the atmospheric ozone layer, neither in the refrigeration circuit nor in the insulation.

## Cleaning, sanitization and maintenance of the ice and/or water dispenser (if present) 1.3

Failure to follow the instructions regarding sanitizing can compromise the hygienic safety of the water dispensed.

- When using the appliance for the first time and every time the filter is changed, it is recommended to let the water flow in the circuit using the "Manual Cleaning" and discard the ice produced in the first 24 hours.
- If the water dispenser has not been used for more than 4/5 days, it is advisable to clean the circuit and run off the first litre of water.
- Reposition the removable water dispenser (if present), ensuring your hands are hygienically clean.
- Clean the ice bucket or drawer regularly but using only drinking water.
- The filter must be changed when indicated on the control panel or when the ice/water dispenser has not been used for more than 30 days.
- With each filter replacement, sanitise the ice and/or water distribution system using a food grade disinfectant (with sodium hypochlorite), which does not alter the characteristics of the materials, or use the "Sanitising Kit" available from the After-Sales Service. Rinse with at least 2 litres of water before use.
- Only original spare parts supplied by the manufacturer should be used when replacing components in the ice and water dispenser.
- Any work on the appliance must be carried out by a qualified technician or the After-sales Service.

## 2 Installation

### 2.1 Installation

Make sure that installation is performed correctly, adhering to all directions in the specific installation manual provided with the appliance.

### 2.2 Connection to the electrical power supply

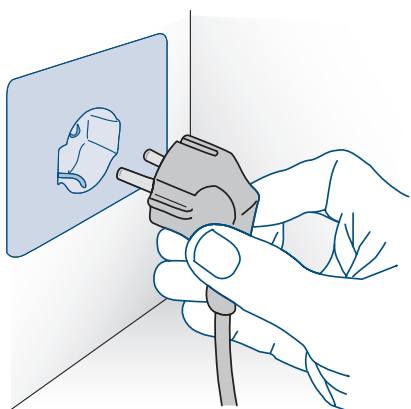

The appliance is equipped with a Schuko type 16A plug and must be connected to the electrical power supply through a corresponding Schuko socket.

Do not use extension cords and/or multiple adapters for the power supply connection.



**Do not use extension cords and/or multiple adapters for the power supply connection.**



**If energy is supplied through an alternative energy power source (solar, geothermal, etc..) or if home automation systems are installed, it is necessary to install the Alternative Energy Kit to integrate the unit into the power grid.**

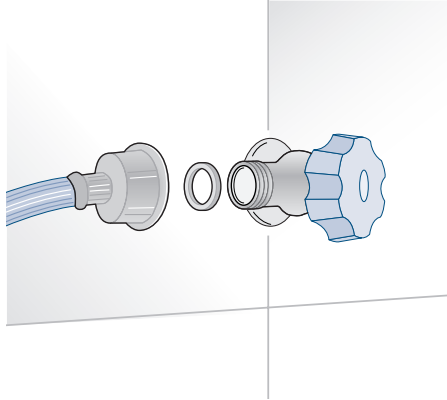

The models provided with Ice Maker require a connection to the domestic water supply system. This can be executed through the provided water hose with 3/4" threading.

The system pressure must be between 0.05 MPa and 0.5 MPa (between 0.5 Bar and 5 Bar).

Different pressures can cause malfunctions or leaks in the water system. The appliance should be supplied only with drinkable water.



**The appliance should be supplied only with drinkable water.**



**Make sure that installation is performed correctly, according to all of the directions in the specific installation manual provided with the appliance.**



**Do not attempt to use a locally sourced garden hose threaded adapter or braided supply line. It will strip the threads on the appliance water connection solenoid.**

## 3 Before starting

### 3.1 Know your appliance

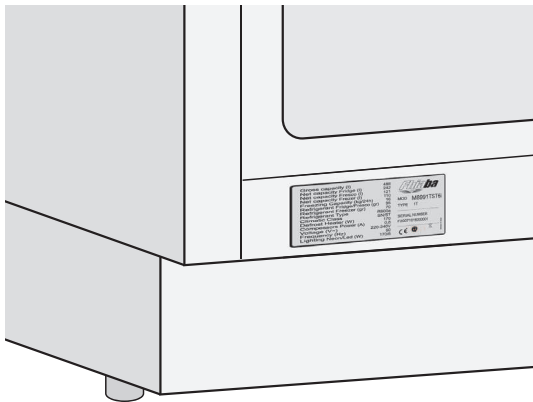

Congratulations for having purchased your new Fhiaba: from now on you can use our innovative conservation system, which will allow you to keep all of your food in the best way possible.

This manual will answer most of your questions about the product's features. Should you require further information, please check our website

**[www.fhiaba.com](http://www.fhiaba.com)**

or write us an e-mail at

**[care@fhiaba.com](mailto:care@fhiaba.com)**.

Before calling, write down the model type and serial number which are available on the warranty certificate and on the rating plate located on the bottom left-hand corner of the appliance, behind the bottom drawer and any messages which may have appeared on the display.

**+39 0434 420 160**

### 3.2 Main features

- Exclusive design by Giugiaro
- The Fhiaba TriMode refrigeration system and the efficient separation of internal compartments ensures maximum freshness and offers excellent conservation of foods in the three compartments: refrigerator, Crisper-Fresco and freezer
- It is also possible, should there be a need, to further increase the flexibility of the appliance by making the freezer compartment operate as a refrigerator or as a Crisper-Fresco compartment
- The Crisper-Fresco compartment has a low temperature and controlled humidity, providing excellent conservation in superior preservation conditions for fresh foods
- Electronic control guarantees constant temperature and humidity levels set by the user and provides real-time compartment temperature readings.
- An interactive menu (Menu) allows customized management of appliance functions and the visualization of functioning messages
- Power save features to reduce consumption during vacation periods
- Ample drawer space with Soft self-closing systems in the Crisper-Fresco area
- Ice Maker for automatic ice production of variable cube size
- Easily replaceable water filter located inside the refrigerator
- Patented adjustable shelf system, with shelves that can be positioned at any level inside of the refrigerator without having to be removed
- Stainless steel surface both inside and outside, with fine aluminum trim
- Patented hinge system that permits automatic door closing
- External drawers with to self-closing system
- Localized lighting with LEDs
- Anti-tipping system by means of wall mounting brackets

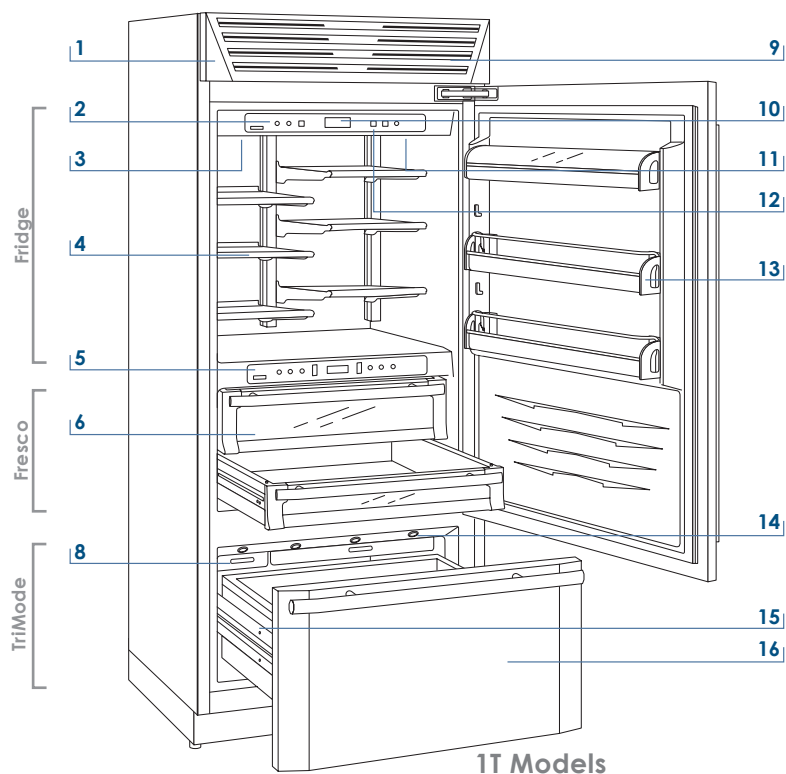

**Single drawer Fridge**

- 1 Stainless steel structure with aluminum trim
- 2 Control panel with Menu
- 3 Water Filter
- 4 Patented shelf positioning system
- 5 Control panel, Fresco area
- 6 Fresco compartment with controlled humidity
- 7 "Low Temp" drawer with controlled humidity
- 8 Automatic icemaker
- 9 Double refrigeration system
- 10 Temperature display
- 11 Sound signals
- 12 Vacation function
- 13 Spacious door shelves
- 14 Innovative lighting
- 15 Automatic door and drawer closure
- 16 Freezer compartment that can be transformed into a refrigerator or Fresco compartment (TriMode function)

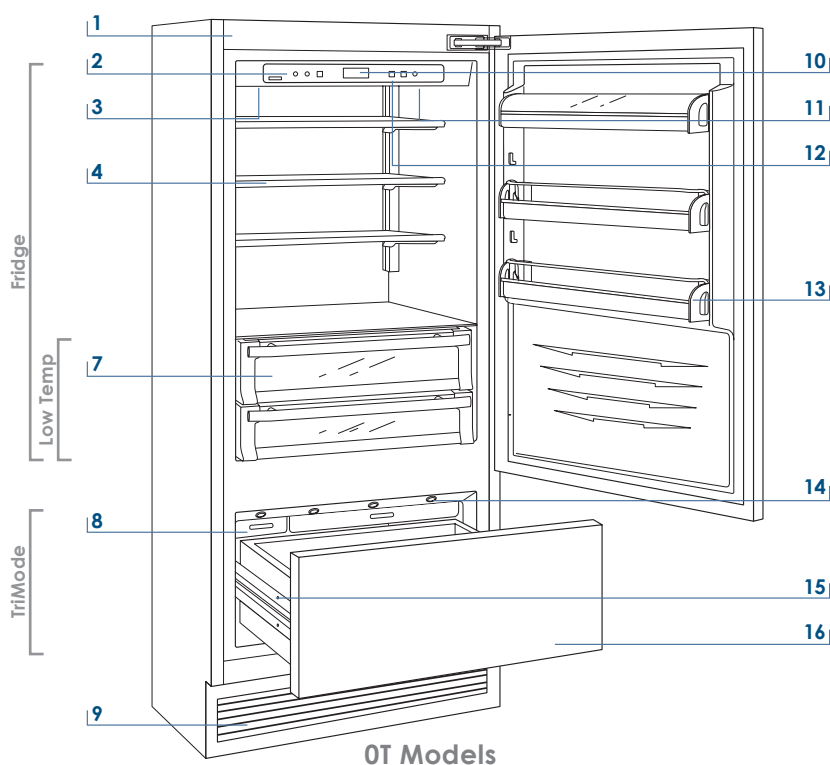

## 3 Before starting

### 3.3 Main components

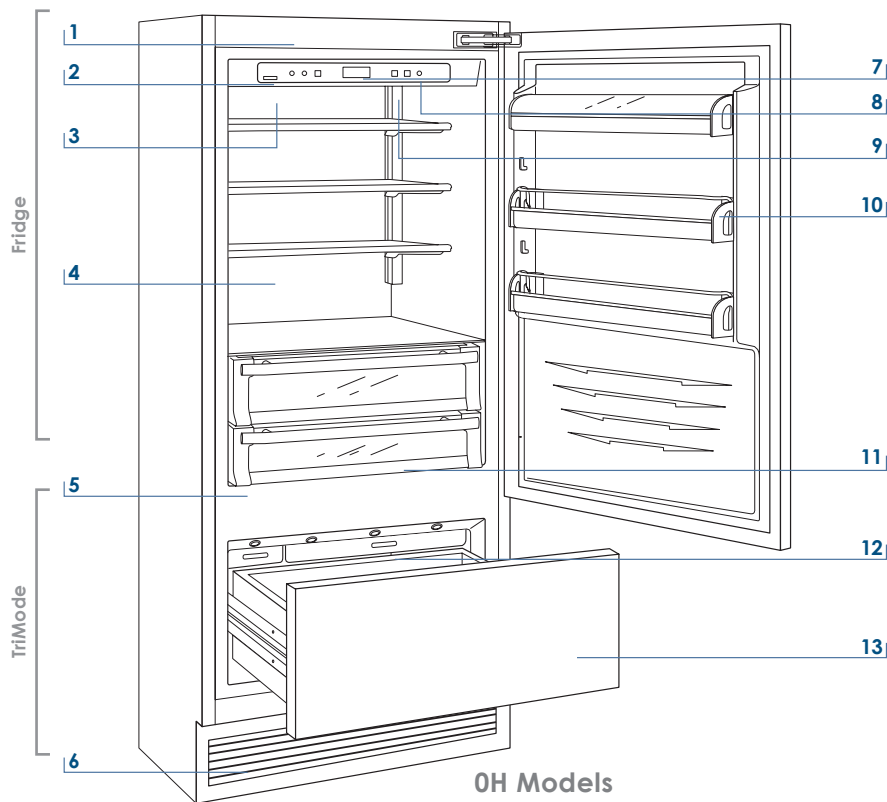

#### Two drawer Fridge

- 1 Stainless steel structure with aluminum trim
- 2 Control panel with Menu
- 3 Water Filter
- 4 Patented shelf positioning system
- 5 Automatic icemaker
- 6 Double refrigeration system
- 7 Temperature display
- 8 Sound signals
- 9 Vacation function
- 10 Spacious door shelves
- 11 Innovative lighting
- 12 Freezer compartment that can be transformed into a refrigerator or Fresco compartment (TriMode function)
- 13 Automatic door and drawer closure

Electronic Control **3.4**

The innovative electronic control system designed by Fhiaba maintains constant temperature on the three compartments and visualizes it on the control panel display. It also allows user interaction making it possible to personalize settings of the various functions and to receive sound and/or visual messages should occur any malfunction in the appliance.

Main control panel **3.5**



- |   |  |                                  |   |
|---|--|----------------------------------|---|
| 1 |  | <b>Unit</b>                      | Switches the appliance (all compartments) between ON and STAND BY (press for three seconds).  |
| 2 |  | <b>Fridge</b>                    | Allows switching on and off of only the refrigerator compartment (press for three seconds).   |
| 3 |  | <b>Menu</b>                      | Allows access to the appliance function menu  |
| 4 |  | <b>Up/down Fridge</b>            | Using the Up and Down buttons, it is possible to change the set temperature of the refrigerator and navigate through the interactive menu.    |
| 5 |  | <b>Display</b>                   | It shows the temperature of the refrigerator and freezer compartments, the date and time, Menu functions and visual messages.                 |
| 6 |  | <b>Up/Down Freezer (TriMode)</b> | By selecting Up/Down the preset temperature can be changed according to the selected function mode (freezer, refrigerator, Fresco).           |
| 7 |  | <b>Enter</b>                     | Confirms activation or deactivation of the selections made in the Menu.   |
| 8 |  | <b>Ice maker</b>                 | Allows activating or deactivating the automatic ice production.   |
| 9 |  | <b>Alarm</b>                     | Blinks to signal user alerts such as door left open, also in combination with a sound signal which can be deactivated by pressing the button. |

Fresco control panel **3.6**



- |    |  |                |   |
|----|--|----------------|---|
| 11 |  | <b>Display</b> | Shows the temperature of the Fresco compartment.  |
| 12 |  | <b>Up/Down</b> | Using the Up and Down buttons, it is possible to change the temperature set for the Fresco compartment. |
| 13 |  | <b>Crisper</b> | Allows switching on and off of only the Fresco compartment (press for three seconds).                   |

## 4 Appliance switching on and off

### 4.1 Switching on and off

**First startup** When the appliance is connected to the electrical power supply but has not yet been switched on, the display shows the message

**Stand by**

This is a safety message to warn that the appliance is connected to the mains, and all the panel buttons are off.

To switch on all the appliance compartments, press the Unit button  for three seconds.

#### **Switching off the Refrigerator and Fresco compartments**

When the appliance is first switched on the TriMode compartment is set to the "freezer" mode. After switching on it remains always on and can be switched off only by switching off the complete appliance. Press Unit  for three seconds.

#### **Restarting**

Use the same buttons to restart. The freezer compartment always stays on and cannot be switched off except by completely switching off the appliance by pressing the Unit button  for three seconds.

#### **Switching off for long periods**

During long absence periods it is recommended to switch off the refrigerator by pressing the Unit button  for three seconds and disconnecting the electrical plug or the breaker controlling the socket.

Completely empty the refrigerator, clean and dry it and leave the doors and drawers partially open to prevent unpleasant odors.



If at the first startup the Standby message does not appear, but another message appears, it means that the appliance has already started the cooling process. If this is the case, deactivate any possible sound signal by pressing the Alarm button , close the door and wait until the set temperature is reached.

During the first startup, it will not be possible to use the Menu to modify the factory settings until the preset temperature has been reached.

Each time the appliance is switched on it goes through a self-diagnosis procedure lasting three minutes before completely starting up.

If only the refrigerator compartment or the Fresco compartment is switched off, the specific fan will continue to operate to prevent the formation of unpleasant odors and mold.

Before switching off the appliance for a long period of time, remove all of the items inside and leave the doors and drawers open to prevent the formation of unpleasant odors and mold.

### How to adjust the temperature for different requirements 4.2

Each model has been carefully tested before leaving the factory and is adjusted in such a way to ensure high performance and low consumption. Usually, it is not necessary to modify the settings. Nevertheless, according to special needs, it is possible to modify the set temperatures as follows:

**Refrigeration Compartment** From +2°C to +8°C (from 35.6°F to 46.4°F), the recommended preset temperature is +5°C (41°F).  
To adjust the temperature use the Up/Down buttons .  
Upon touching these buttons the newly set temperature will appear in the display. To modify this temperature, use the buttons until reaching the desired temperature.

**Fresco Compartment** From -2°C to +2°C (from 28.4°F to 35.6°F), the recommended preset temperature is 0°C (32°F).  
To adjust the temperature use the Up/Down buttons .  
Upon touching these buttons the newly set temperature will appear in the display. To modify this temperature, use the buttons until reaching the desired temperature.

**Freezer Compartment (TriMode)** From -15°C to -22°C (from 5°F to -7.6°F), the recommended temperature is preset at -18° (0°F).  
To adjust the temperature use the Up/Down buttons .  
Upon touching these buttons the newly set temperature will appear in the display. To modify this temperature, use the buttons until reaching the desired temperature.





The temperature shown can vary slightly in respect to the set temperature following frequent openings of the doors or insertion of room temperature foods or large quantities of foods.

6 to 12 hours are necessary to reach the selected temperature.

In case the compartment is used as refrigerator or Fresco compartment (TriMode function) the recommended and preset temperatures will correspond to those indicated for the respective compartments.

### Ice Maker Activation 4.3

The Ice Maker button  located on the main control panel permits activation of the automatic icemaker. The button is illuminated when the icemaker is functioning.

A prewash of the hydraulic circuit should be performed before activating the Ice Maker for the first time. To do this touch at the same time buttons Enter  and Ice Maker .  
After a few minutes the Ice Maker can be activated.



Do not activate the Ice Maker unless the appliance is connected to the water mains.

### Information and malfunction messages on the display 4.4

An integrated control system provides information through lighted signals or text messages visualized on the display. The information signal is always visualized with a fixed text message, while a malfunction signal is visualized with blinking text. The sound signal that accompanies some malfunction signals can be deactivated by pressing the Alarm button  on the main control panel. The list of malfunction signals is located at the back of this manual.

## 5 Settings and Special Functions

### 5.1 Customization and language settings



To prevent an inadvertent change to the settings the keypad is automatically locked after a certain period of time.

To re-activate the Menu function, press simultaneously the Menu button and the Down button for at least three seconds.

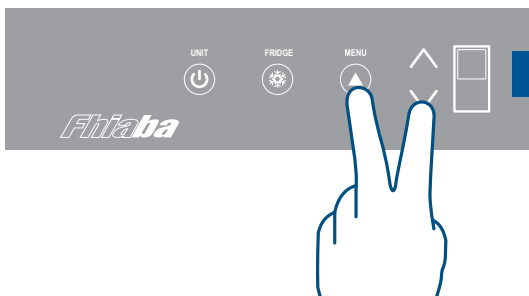

It is possible to customized the functions of your Fhiaba to adapt it to diverse usage needs, resetting the main parameters (Settings) or activating special functions (Functions).

Functions are visualized on the main display by pressing the Menu button .

The Up/Down buttons permit scrolling the available functions, which can be selected by pressing the Enter button . The display visualizes the current functioning status.

Using the Up/Down buttons , it is also possible to scroll through the selected function, activating or deactivating by pressing the Enter button . Once the function is confirmed, the display will automatically visualize the main menu to select other functions.

At any time it is possible to return to the previous selection through the FhiabaAccess button .

The language of the messages appearing on the display can be changed by operating as follows:

Enter the Menu by pressing the Menu button select Settings via the Up/Down buttons and confirm via Enter . Then select the Language function and the desired language.

### 5.2 Special functions activated through the Menu

To use special functions, select the Menu button and use the Up/Down button to access the menu, confirming the selection Functions.

#### Shopping Fridge

The function lowers the refrigerator temperature to +2°C (35.6°F) for 12 hours, permitting more rapid cooling of food that has just been placed in. Once the 12 hours have expired, the function deactivates automatically, returning to the previously set temperature. It is possible to program a timed activation of the function. After a prolonged interruption of electrical current, it is necessary to reactivate the function.

#### How to activate

Functions → → Shopping Fridge → →   
Shopping Fridge ON/OFF → → Shopping Fridge On

#### How to deactivate

Functions → → Shopping Fridge → →   
Shopping Fridge ON/OFF → → Shopping Fridge OFF

#### How to program timed activation

Functions → → Shopping Fridge → →   
Shopping Time → → Set Hours: 1 →



The various Shopping Modes help prepare the cooling, Fridge and TriMode compartments for the introduction of a heat load which can consist of fresh food or other items which may have warmed during transport. The more quickly an item can be cooled or frozen the better it will be preserved.

This mode can also be effective at maintaining compartment temperatures while entertaining when higher than average door and drawer openings are anticipated.

It is possible to program the function with a delay of 1 to 12 hours.

**Vacation Fridge** This function (recommended in case of prolonged absences since it allows considerable energy savings) brings the refrigerator compartment temperature to +14°C (57.2°F). It is possible to program the duration, or it can be manually deactivated upon re-entry after a period of absence. This function remains active even if during the period of absence there is a prolonged interruption of electrical power.

- How to activate** Functions → ✓ → ⬆ Vacation Fridge → ✓ → ⬆  
 Vacation ON/OFF → ✓ → ⬆ Vacation Fridge On → ✓
- How to deactivate upon re-entry** Functions → ✓ → ⬆ Vacation Fridge → ✓ → ⬆  
 Vacation ON/OFF → ✓ → ⬆ Vacation Fridge OFF → ✓
- How to program the duration** Functions → ✓ → ⬆ Vacation Fridge → ✓ → ⬆  
 Vacation Time → ✓ → ⬆ Set Days: 1 → ✓

It is possible to program a period from 1 to 90 days.

**Shopping TriMode** This function must be activated at least 24 hours before inserting room temperature items into the freezer, or several hours before placing into the freezer previously frozen items which have been subject to a slight temperature rise. This function is automatically deactivated when the programmed time period expires. It is possible to program timed activation of the function. If interrupted by a prolonged interruption of the electrical power, it is necessary to reactivate the function.

- How to activate** Functions → ✓ → ⬆ Shopping TriMode → ✓ → ⬆  
 ShoppingTriMode ON/OFF → ✓ → ⬆ Shopping TriMode On
- How to deactivate** Functions → ✓ → ⬆ Shopping Fridge → ✓ → ⬆  
 ShoppingTriMode ON/OFF → ✓ → ⬆ Shopping TriMode Off
- How to program timed activation** Functions → ✓ → ⬆ Shopping TriMode → ✓ → ⬆  
 Shopping Time → ✓ → ⬆ Set Hours: 1 → ✓

It is possible to program the function with a delay of 1 to 12 hours.

## 5 Settings and Special Functions

**Vacation TriMode** This function (recommended in case of prolonged absences since it allows considerable energy savings) brings the TriMode compartment temperature to - 18°C (46.4°F). It is possible to program the duration, or it can be manually deactivated upon re-entry after a period of absence. This function remains active even if during the period of absence there is a prolonged interruption of electrical power.

- How to activate** Functions → ✓ → ^ Vacation TriMode → ✓ → ^  
 Vacation ON/OFF → ✓ → ^ Vacation TriMode On → ✓
- How to deactivate upon re-entry** Functions → ✓ → ^ Vacation TriMode → ✓ → ^  
 Vacation ON/OFF → ✓ → ^ Vacation TriMode OFF → ✓
- How to program the duration** Functions → ✓ → ^ Vacation TriMode → ✓ → ^  
 Vacation Time → ✓ → ^ Set Days: 1 → ✓
- It is possible to program a period from 1 to 90 days.

**Bottle Cooler** This function can be activated when it is necessary to cool off beverages quickly, by placing them inside the freezer compartment. It is possible to select a duration of 1 to 45 minutes. A sound signal will be indicated when the optimal temperature has been reached. After removing the beverages, deactivate the sound signal by pressing the Alarm button (🔔).

- How to activate** Functions → ✓ → ^ Bottle Cooler → ✓ → ^  
 Bottle Cooler ON/OFF → ✓ → ^ Bottle Cooler On → ✓
- How to deactivate** Functions → ✓ → ^ Bottle Cooler → ✓ → ^  
 Bottle Cooler ON/OFF → ✓ → ^ Bottle Cooler OFF → ✓
- How to program the duration** Functions → ✓ → ^ Bottle Cooler  
 Set Cooling Time → ✓ Set time : 20 min → ^ → ✓

**Ice Maker** The IceMaker function permits selecting the size of the ice cubes, by choosing between Large (base setting) or Medium, and activation of the SuperIce function, which increases the quantity of produced ice. The SuperIce function deactivates automatically after 24 hours.

- How to activate the cube size function** Functions → ✓ → ^ Ice Maker → ✓ → ^  
 Set Cube Size → ✓ → ^ Size: Large → ^ → ✓
- How to deactivate** Functions → ✓ → ^ Ice Maker → ✓ → ^  
 Set Cube Size → ✓ → ^ Size: Medium → ^ → ✓
- How to activate the SuperIce function** Functions → ✓ → ^ Ice Maker → ✓ → ^  
 SuperIce ON/OFF → ✓ → ^ SuperIce On → ✓
- How to deactivate** Functions → ✓ → ^ Ice Maker → ✓ → ^  
 SuperIce ON/OFF → ✓ → ^ SuperIce Off → ✓

### Sabbath Mode (Optional)

The function makes it possible to comply to certain religious observances requiring that the operation of the appliance is not affected by the opening or closing of the doors (the thermostatic control, the inner lighting and the ice maker are deactivated).

#### How to activate

Functions → ✓ → ⬆ Sabbath Mode → ✓ → ⬆  
Sabbath Mode ON/OFF → ✓ → ⬆ Sabbath Mode On → ✓

#### How to deactivate

Functions → ✓ → ⬆ Sabbath Mode → ✓ → ⬆  
Sabbath Mode ON/OFF → ✓ → ⬆ Sabbath Mode Off → ✓

### Water Filter

The View Status function permits visualizing the time left before the filter needs to be replaced.

#### How to check the status of the filter

Functions → ✓ → ⬆ Water Filter → ✓ → ⬆ Filter Status  
→ ✓ → ⬆ View Status → ✓

### Reset Filter

The Reset Filter function sets to zero the time left before the filter needs to be replaced. It is necessary to set the meter to zero each time the cartridge is replaced.

#### How to set the filtered water meter to zero

Functions → ✓ → ⬆ Water Filter → ✓ → ⬆ Filter Status  
→ ✓ → ⬆ Filter Reset → ✓

### Bypass Filter

This function is to be activated when it is not necessary to filter the water, because excellent quality water is already available from the home water system.

#### How to activate filter Bypass

Functions → ✓ → ⬆ Water Filter → ✓ → ⬆ Filter Status  
→ ✓ → ⬆ Filter Bypass → ✓ → ⬆ Filter Bypass On → ✓

#### How to deactivate filter Bypass

Functions → ✓ → ⬆ Water Filter → ✓ → ⬆ Filter Status  
→ ✓ → ⬆ Filter Bypass → ✓ → ⬆ Filter Bypass Off → ✓

### Manual Clean, Water Filter

If ice production has been disabled or unused for a long period it is recommended to perform a Manual Clean function to flush out water which has sat in the system during this period. Repeat the operation until the water is clean.

#### How to manually clean the filter



Functions → ✓ → ⬆ Water Filter → ✓ → ⬆  
Manual Clean → ✓ → ⬆ Enter to confirm → ✓



Correctly position the ice tray or another suitable container under the IceMaker to collect water, then close the drawer.  
At the end of the operation, wash the tray.

# 5 Settings and Special Functions

## 5.3 Basic settings of the Menu

Select the Menu button  and used the Up/Down button  to select Settings.





**TriMode Options** The freezer compartment can, if required, be converted to the refrigeration or Fresco operating mode.

**How to set the Fridge function** Settings →   TriMode Options →    
Fridge →  Enter to confirm → 

**How to set the Fresco function** Settings →   TriMode Options →    
Fresco →  Enter to confirm → 

**How to revert to the Freezer function** Settings →   TriMode Options →    
Freezer →  Enter to confirm → 

**Default Setting** This offers the possibility to reset default factory settings and cancels any previous changes.



**How to reset default settings** Settings →   Default Setting →   
Enter to confirm → 



**ATTENTION:** If the default settings are restored, the default mode of the TriMode compartment is freezer mode. If it was previously being used in refrigerator or Fresco mode be sure to set it back to your desired setting.

### Date

#### Set Date

The display will show the date in the format dd:mm:yy (day:month:year), the day will blink. Use the Up/Down buttons  to modify the setting, confirm with Enter  to go on to the next setting; once the year is confirmed the date will be set.

**How to set the date** Settings →   Date →   Set Date  
→   DATE: 01-01-2009 → 

#### Show Date



Using this function it is possible to deactivate/activate the date visualization on the display.

**How to activate the date** Settings →   Date →   Show Date  
→    DATE: 01-01-2009 On → 

**How to deactivate the date** Settings →   Date →   Show Date  
→    DATE: 01-01-2009 OFF → 

### Time

#### Set Time

The display shows the hours and minutes in the format hh:mm and with hh: blinking. Use the Up/Down buttons  to modify the setting and then confirm by pressing Enter  to go on to the next setting. Once the minutes are confirmed, the time will be set.

**How to set the time** Settings →   Time →   Set Time  
→   TIME: 01:01 → 



**Set 12/24** This function selects the display at 12 or 24 h.

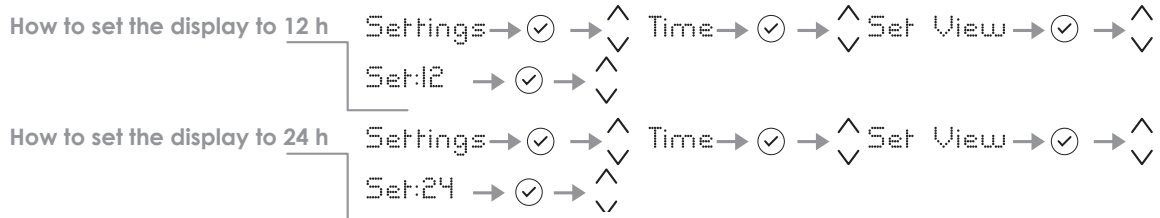

**Show Time** Through this function it is possible to activate/deactivate the constant visualization of the time.

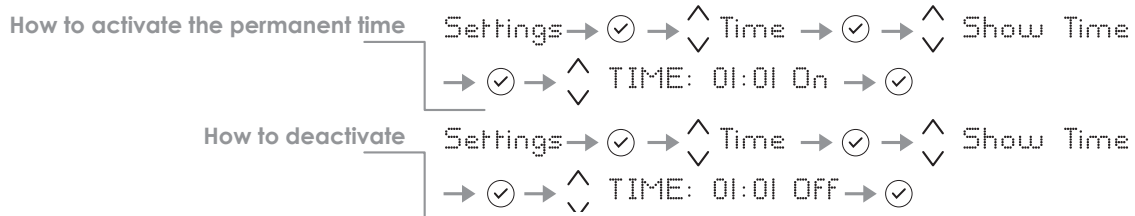

**Language** The function allows selection of the language for the display messages.

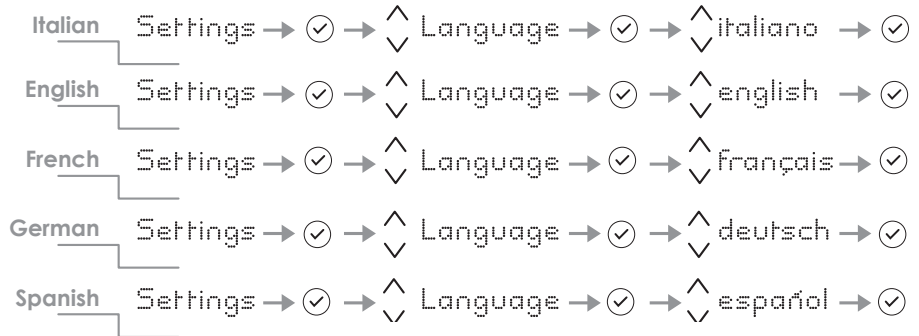

**Set °C/°F** This function permits visualizing the temperature in Centigrade or Fahrenheit degrees. Normally, the appliance is set for visualization in centigrade degrees.



Internal Layout (positioning, adjustment, removal) **6.1**

**Fresco Drawer**

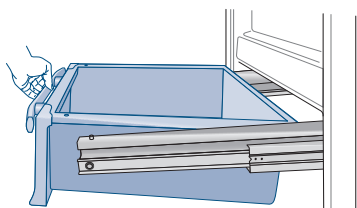

Fixed to the slide guides with two thumbscrews.

- to remove the drawer, unscrew the thumbscrews and remove the drawer.

**TriMode Drawer**

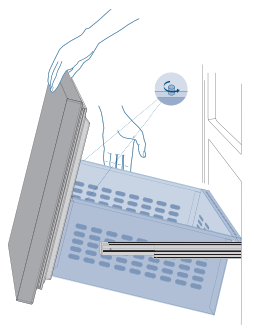

The upper TriMode can be removed using the same method used for the Fresco drawer

- to remove the inner TriMode drawer unscrew the thumbscrews.

**When replacing the drawers, make certain the back of the drawers engage under the clips on the slide guides.**

## 6 Internal Layout

### Ice Tray

Located in the upper drawer of the freezer compartment

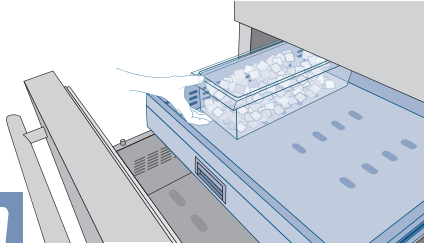

**Do not place hands or fingers near the Icemaker when in function.**

- after removal, make sure to reposition it correctly.

### Shelves

The shelves are sliding and can be easily re-positioned by the user as follows:

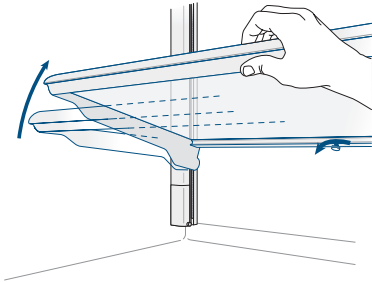

- release the locking knob by turning it anti-clockwise

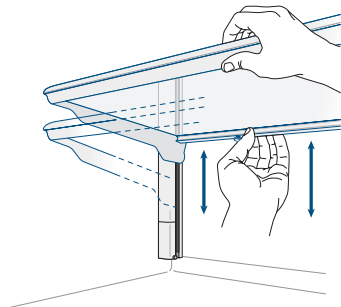

- lift or lower the shelf to the desired position
- re-tighten the locking knob
- to remove a shelf it is necessary to slide it up to the top

### Door Shelves

The door shelves can be easily removed for cleaning

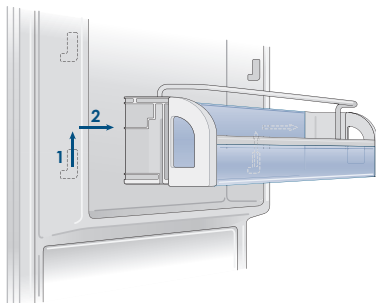

- Hold the door shelf at the sides and push it upwards to release it from its seat, then pull it outwards.
- Reverse the procedure to reinstall.



If the ice is not used frequently is advisable to empty the ice bin once every 8-10 days.

It is normal that some ice cubes stick to one another. If the ice is not frequently used, the older cubes can become opaque, and will have a strange flavor and become smaller.

The Icemaker automatically deactivates if the Vacation function is activated.

When the Icemaker is started for the first time, it is recommended to dispose of the first full bin of ice.

If the equipment has been switched off for a month or more, it is recommended to perform a water cleaning cycle.

The ice maker will only produce ice with the TriMode compartment set to Freezer Mode. The ice maker will continue to operate even when the ice bin is not in position

To activate the Ice Maker after installation of the appliance, press the Icemaker button

Please note that 12 to 24 hours are necessary before ice production may begin. The production is of 10 cubes per cycle in approximately 10 cycles in 24 hours.

The yield depends on the temperature set in the freezer, the room temperature and the frequency of door opening. If the appliance is operating without being connected to the water system, make sure that the Icemaker is deactivated by pressing the button .

The Ice Maker produces ice until the ice tray is full and will automatically stop once the maximum level is reached.

With the SuperIce function, it is possible to increase the quantity of ice produced a 24 hours, while the Set Cube Size function permits selection of the size of the produced ice cubes.

At factory default settings Ice Maker can produce approx. 100 ice cubes within 24 hours.

**Do the ice cubes have an unusual odor?**

Ice is a porous material which can absorb odors from the environment. Ice cubes which have been in the ice cube container for a long time may absorb odors, stick together and slowly become smaller.

We recommend that old ice cubes not be used.

Other means of preventing odors:

- The ice cube container should be cleaned occasionally with warm water. Make sure that you switch off the ice maker before clearing the container. Rinse out and wipe dry.
- Check the contents of the freezer for spoiled or out-of-date food. All odorous foods should be wrapped thoroughly or stored in airtight containers to prevent the build-up of odors.
- The water filter may have to be replaced in some models.
- In some cases the quality of the water connection in the house should be checked.

**Operating noises  
Quite normal noises**

- Grumbling: refrigerating unit is running. Fan in the recirculating air system is running.
- Bubbling, humming or gurgling noises: refrigerant is flowing through the tubes.
- Clicking: motor is switching on or off. Solenoid valve on the water connection is opening/closing.
- Rumbling: ice cubes are falling into the ice cube container.
- Note: the appliance is powered by two independent compressors. It is therefore normal to always have one of two compressors in operation.



Do not place any bottles or food for rapid cooling in the ice cube container. The ice maker may become blocked and be damaged.

# 7

## Activation and use of the Ice Maker

### 7.2 Water Filter

The Water Filter makes available high-quality water for the production of ice cubes. It provides up to 3000 liters of water for a maximum time of six months.

On some models, on the upper right of the control panel it is possible to monitor the use status of the filter: when the entire area is illuminated the filter has just been replaced; the white illuminated area indicates that the filter capacity is below 20%. When the filter is nearly expired the message "Replace Filter Cartridge" will appear on the display.

#### Filter Replacement



The filter is located inside the refrigerator compartment, above the top glass panel. Prior to changing the filter, switch off the Ice Maker by pressing the IceMaker button. Then enter the Fhiaba Access Menu and set "Manual Clean" function. At the end of the cleaning cycle remove the water from the ice tray and wipe it dry.

Open the top glass panel and carefully rotate the filter cartridge for a quarter rotation in a counter clockwise direction until it detaches from its housing. It is normal for a small quantity of water to come out. Remove the cap of the new cartridge and insert it into the housing by gently rotating it for a quarter rotation in a clockwise direction until it locks into place.

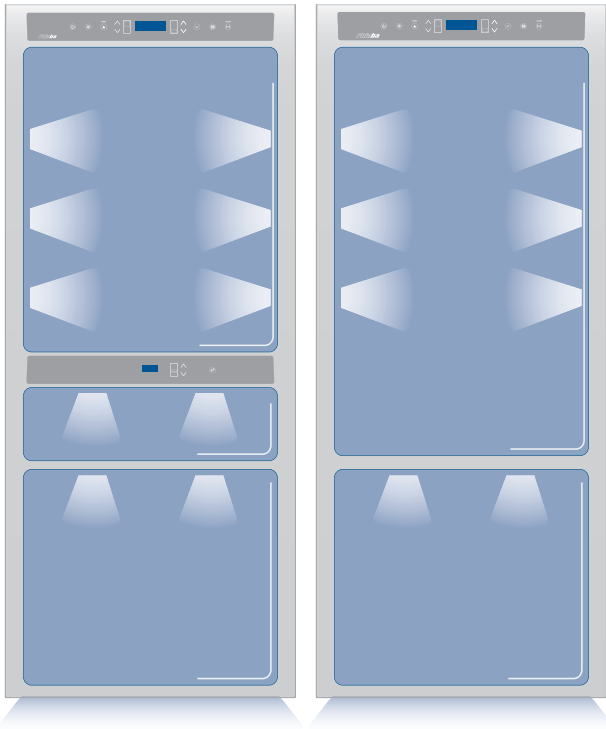

To provide optimum interior lighting, LED strips illuminate the refrigerator compartment from the top and sets of LED lights directly illuminate different areas of the refrigerator compartment, of the Crisper-Fresco drawers and the freezer drawer.

In case of malfunction and/or wearing out of the lighting system, the repair should be carried out by a qualified Fhiaba Service technician.

## 9 Food Preservation

### 9.1 General directions

Your Fhiaba is designed to ensure precise, constant temperatures and appropriate humidity levels in all compartments.

In addition, the double refrigeration ensures that frozen foods and ice do not absorb the odor of fresh foods and that the humidity in the refrigerator does not freeze and build up frost.

Nevertheless, to properly preserve all of your foods, it is not enough to have an excellent refrigerator. It is also necessary to know the rules for correct food preservation.

Do bear in mind that all foods will inevitably change their characteristics over the passage of time. This change begins long before the food is consumed, since foods contain micro organisms which multiply and can cause deterioration. This process occurs more rapidly due to improper handling, preservation temperatures and humidity levels.

It is therefore recommended to follow the directions presented below which will permit using your refrigerator/freezer in the most effective and safe manner to keep your foods in the best way for as long as possible.

Bear in mind that the Crisper-Fresco area is the area for preserving the most delicate fresh foods, since it ensures constant average temperature near freezing.

Periodically check that all foods are in a perfect state of preservation. It is usually quite clear when a food item is deteriorated, due to mold, unpleasant odor and unpleasant aspect. Nevertheless, there are cases in which these conditions are not so evident. If you believe that a food item was kept for an excessive period of time and may be deteriorated, do not consume this item or even taste it, even if it seems to still be healthy, since the bacteria that cause deterioration of food can also cause poisoning and illness.

When in doubt, throw the food away.



### 9.2 TriMode compartment

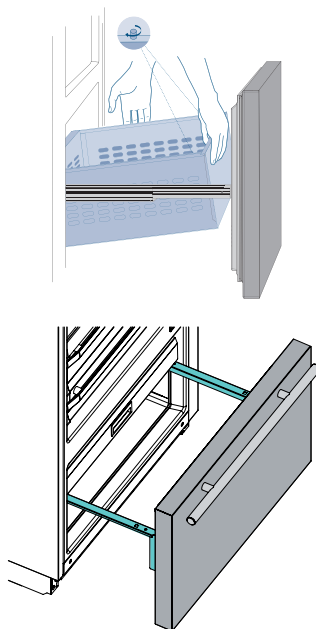

To fully use the capacity of the TriMode compartment:

- remove the drawer
- remove the top drawer
- install the supports delivered with the units (on request)

## How to maintain good food quality 9.3

### When buying groceries

Always take the following precautions:

- Place any packages of raw meat, fish or poultry in plastic bags so that they do not drip on other foods.
- Purchase meat, poultry and fish last. Do not leave your groceries in a warm car after shopping. Keep a freezer bag in your car and use it in case of very high temperatures or long trips.
- Check the production dates and "best before" times on foods to be sure that they are fresh.
- Be very careful when buying fresh foods, and only buy a quantity that can be consumed during your planned preservation period.
- When possible, let warm foods adjust to room temperature for at least two hours before placing them in the refrigerator, unless you have activated the Shopping function before.

### When placing foods in

Check the refrigeration temperature of the various compartments on the control panel:

- The refrigerator temperature must be 8°C (45°F) or lower and the freezer temperature must be -18°C (0°F)
- Follow the recommendations regarding the preservation times and temperatures indicated in the tables to follow.
- Keep raw meat, fish and poultry separate from other foods and avoid any possible drippings.

### When placing foods in

- When placing in the refrigerator your meat, fish or poultry, leave these in their original packaging, unless the packaging is ripped or punctured. Repeated handling could introduce bacteria into these foods.
- To keep food in the freezer is a good idea to use freezer containers, with plastic freezer bags or aluminum foil around the freezer containers, if you intend to preserve the food for more than two months. This will minimize dehydration and deterioration
- Label and date the packages
- To keep foods in the refrigerator, wrap these in plastic film or deposit them in plastic containers or vacuum packed containers to avoid drying. Always mark with the date the packages or containers.
- Be careful to correctly position the food items on the shelves in a way that does not obstruct the air circulation vents inside the compartment.

### When preparing food

- Wash all items that have come in contact with food
- Carefully wash hands before and after contact with food
- Sterilize containers, utensils and kitchen tools that have come into contact with meat, fish and poultry.
- Sterilize sponges used to wash kitchenware weekly.
- Use plastic gloves if you have any hand condition.
- Defrost foods in the refrigerator or in the microwave oven, not on the countertop. If you use a microwave oven to defrost food, cook the food immediately.
- Marinate food only in the refrigerator.
- Rinse fish and poultry before cooking.
- Avoid contamination when preparing dishes. Keep raw meat, fish, poultry and their liquids away from other food items. For example, do not use the same surface or the same utensils for preparing meat, fish, poultry and vegetables.
- Keep your cutting boards perfectly clean, whether made from wood or plastic.
- Wash cutting boards with warm water and soap, and rinse with a diluted disinfecting solution.

**When cooking food**

- Do not taste raw or partially cooked meat, poultry, fish and eggs.
- Cook meat at a temperature of 75°C (167°F) or higher. For cuts of meat over 5 cm, use a meat thermometer to check the temperature. For thinner cuts of meat, to check if it is cooked, check the color of the juice and whether it is clear or pink.
- If you are cooking meat which is not yet defrosted, increase the cooking time one and half times the normal duration.
- Bear in mind that roasted meat and poultry, when cooked in the oven, need temperatures of 160°C (320°F) or higher.
- Cook the egg whites and yolks until they are well done.
- Do not use the same containers that have contained raw or partially cooked eggs.
- If your oven or microwave is equipped with a probe for temperature control, use it - internal temperatures are the best gauge for determining cooking completion.

**When you have leftovers**

- Keep leftovers in the refrigerator or in the freezer in small closed containers. Before placing them in the refrigerator, make sure that they have cooled off. Therefore let at least two hours pass after cooking and make sure that there is adequate air circulation around the container, so that the food can cool off quickly - this practice avoids increasing the temperature in the fridge / freezer compartment and subsequent cooling cycles as a result.
- Date leftover containers and use them within the recommended time.
- Completely cover and heat leftovers before serving.
- Boil sauces and soups. Consume leftovers after they have been heated to a temperature of at least 75°C (167°F).
- If you think the food is gone bad, or when in doubt, throw it away.

A characteristic unique to Fhiaba products is the combination of micro beaded stainless steel crisper drawers and the main stainless steel interior liner that help generate and maintain optimum internal humidity levels for extended preservation of fruit and vegetables.

A natural condition that may occur, is the accumulation of water on the bottom of the refrigeration compartment below the bottom crisper. This is dependant on a number of factors, ambient temperature and humidity levels in the surrounding environment, moisture levels on fruit and vegetables placed in the refrigerator, frequency in which the main door is opened and exposed to the ambient environment.

This temporary presence of water on the bottom is the result of the high humidity environment maintained in the compartment and is absolutely normal, and under normal operating conditions should be eliminated. However, in rare occasions where there may be an excessive amount of condensation simply remove the bottom drawer and wipe access water away.



**When a high level of humidity is present either in the environment or in the foods placed in the Fresco drawers, the bottom of the Fresco compartment might be covered with some water or ice (if the temperature is set between 0°C and -2°C).**

Such condition is normal and it is due to the high humidity levels of the Fresco compartment; high humidity together with low temperatures is what guarantees a longer preservation of foods.

Water or ice can disappear on its own if the air humidity level should lower; it is also possible to remove the water with a towel. If a thin layer of ice has formed, set the temperature of the Fresco compartment to +2°C and after one day remove the water with a towel.

If the layer of ice is thicker, it might be necessary to shut off the Fresco compartment for one day in order to melt it.

Recommendations for preserving fresh food 9.4



**Vegetables**

Wash vegetables in cold water and dry well. Place vegetables in vacuum packed containers, plastic containers or vegetable bags in a Fresco Drawer.



**Fruit**

Wash and dry fresh fruit. Pack very aromatic fruit in plastic bags. Fruit should be placed in the high humidity Fresco compartment.



**Packaged meat**

Place in the refrigerator in its original packaging. After opening, wrap the remaining food in plastic bags or aluminum foil.



**Fresh meat, fish and poultry**

Remove the original packaging, then put in plastic bags or containers and immediately place in the refrigerator.



**Eggs**

Place the eggs in their package or container into the refrigerator without washing them. Check the "best before" date and at any rate use the eggs within two weeks of purchasing.



**Milk, cream and fresh cheeses**

These should be kept in their original closed packaging. Place these on refrigerator shelves and consume these within five days of purchase.



**Cheeses**

Place these in the Fresco drawer in their original packaging. Once opened, close these hermetically in plastic bags or aluminum foil.

**Leftovers**

Let these cool off and cover hermetically with aluminum foil or place in sealed containers to prevent drying or the spread of odors.

Recommendations for preserving frozen food 9.5



**Frozen food**

Place food in plastic bags for the freezer. These bags must be hermetically sealed against air and humidity. Do not refreeze defrosted meat.



**Ice cream**

The firmness of ice cream depends on the quantity of cream that it contains. In general, high-quality ice cream has large amounts of cream, therefore a very low temperature in the freezer will be necessary to maintain its firmness.

Consequently, ice cream without much firmness is not necessarily an indication of a temperature problem as raised above normal levels.



After a prolonged interruption of electrical power, once the electrical power is reactivated, an audible signal will indicate if the temperature has raised above normal levels. In addition to this the display will show for one minute the highest temperature detected inside the compartments, to allow the user to decide how to better use the food items.

After one minute the display will resume normal operation, while the Alarm button will continue to blink.

Press the Alarm button to display the highest recorded temperatures.

# 10 Recommended times for Food Preservation

Fresh foods	Preservation area	Time
<b>Raw meats</b>		
Large cuts	Fresco Compartment	4 days
Beef steaks, poultry and wild game	Fresco Compartment	3 days
Ground meat	Fresco Compartment	1-2 days
Carpaccio	Fresco Compartment	Immediately
<b>Cooked meat</b>		
Boiled meat and roasted meat	Refrigerator Compartment	2 days
Meat sauce	Refrigerator Compartment	6 days
<b>Fish</b>		
Raw and cooked fish	Fresco Compartment	2 days
<b>Other</b>		
Soups and broths	Refrigerator Compartment	2 days
Pasta	Refrigerator Compartment	2 days
Opened cold cuts	Fresco Compartment	3 days
Fresh cheeses	Fresco Compartment	2-3 days
Well sealed aged cheeses	Refrigerator Compartment	Several months
Eggs (fresh and unwashed)	Refrigerator Compartment	2 weeks
Opened cans	Refrigerator Compartment	2-3 days
Raw vegetables (in perforated bags)	Fresco Compartment	1 week
Frozen foods	Preservation area	Time
Beef, veal, lamb and goat meat	Freezer Compartment	(steaks) 6-12 months
Beef, veal, lamb and goat meat	Freezer Compartment	(Meat with bone) 4-6 months
Ground beef	Freezer Compartment	1-2 months
Pork	Freezer Compartment	(Without bones) 4-6 months
Pork	Freezer Compartment	(With bones) 2-3 months
Ground pork	Freezer Compartment	1-2 months
Meat leftovers	Freezer Compartment	2-3 months
Whole chicken and turkey	Freezer Compartment	8-12 months
Goose, duck and pheasant	Freezer Compartment	4-8 months
Fish	Freezer Compartment	1-2 months
Shellfish	Freezer Compartment	2-3 months
Cooked food	Freezer Compartment	1-2 months
Vegetables	Freezer Compartment	8-12 months
Fruit	Freezer Compartment	6-12 months
Desserts and cakes	Freezer Compartment	2-3 months

## Care and Cleaning 11.1



**Scrupulously follow the detailed directions that can be found in the provided kit and never use abrasive or metallic products which could scratch and damage the satin finishing on the appliance permanently. Before performing any sort of cleaning, disconnect the appliance from the electrical power supply. Make sure you do not damage the refrigerant circuit in any way.**

To clean the parts made of steel use a microfiber cloth and the sponge provided in the kit with the appliance. Always use the cloth and sponge in the direction of the steel's satin finish.

Every now and then, to polish the steel, wipe with a slightly damp microfiber cloth.

Do not use the sponge on aluminium parts, such as the handles and the profiles of the glass shelves.

You should use special care to keep the ventilation openings in the appliance or in the cabinet that houses it free of obstructions.

## Condenser cleaning 11.2

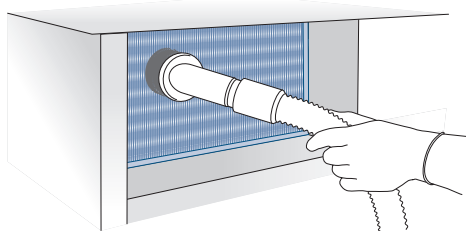
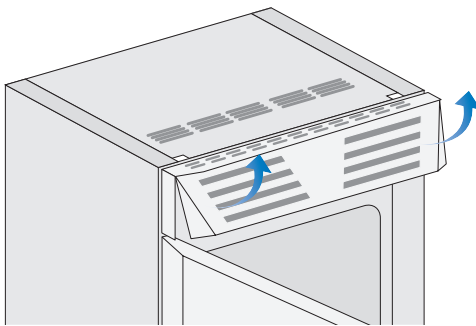



A ventilation grille is located either at the top of the appliance or at the bottom according to the model type.

A foam filter is placed behind the grille to protect from dust the ventilation system (for only StandPlus series)

To clean it use a vacuum cleaner with a soft brush attachment at maximum power, sweeping it along the vent slits. In case of a significant dust build up, the ventilation grille can be removed to allow a more accurate cleaning of the filter.

Take care also to check the condition of the finned condenser and clean it from dust if needed.

Operate as follows:

- Switch off the appliance by pressing the Unit button  on the main control panel for approx 3 seconds.
- On models with ventilation at the base remove the grille at the bottom (magnetically attached) and take it off. On models with ventilation lift the grille as shown in the picture.
- Thoroughly clean the grille and the foam filter, by means of a vacuum cleaner and the soft brush attachment.
- Wait approx 30 minutes, until the finned condenser cools down to room temperature, then clean it thoroughly from any dust build up as shown in the picture, taking care not to damage it.
- Start up the appliance again, by pressing the Unit button  on the main control panel for approx 3 seconds.



**The edges of the condenser are sharp, therefore use adequate protection for the hands and arms when cleaning the condenser.**

## Internal cleaning 11.3



**Do not use water on the electrical parts, lights and control panel.**



**Do not bring cold glass parts into contact with boiling water. Do not wash any parts of the refrigerator in a dishwashing machine since this could damage or irreparably deform the parts.**

Clean the internal and removable parts by washing them with a solution of lukewarm water, a small amount of dishwashing detergent.

Rinse and dry right away.

Do not use mechanical devices or other methods to speed up defrosting.

# 12 Troubleshooting Guide

## 12.1 Troubleshooting Guide

If you notice malfunctions in your appliance, use this guide before calling for service: this guide can help you personally resolve the problem or could provide important information to be conveyed to the service technician to ensure rapid and effective repair.

<b>Malfunction message</b>	A malfunction is usually indicated by a message on the display. Problems that cannot be solved by the user are signaled through a malfunction code.
<b>The refrigerator or the freezer does not work</b>	Is the appliance connected to the electrical power supply? Is electrical power available at the electricity socket? Is the Unit button @ activated? Is the unit in 'Demo' Mode?
<b>The refrigerator or the freezer is warmer than usual</b>	Does the display show a malfunction code? Is the temperature adjusted correctly? Were the doors or drawers open for a long period of time? Were large quantities of food recently inserted? Is the unit in 'Demo' Mode?
<b>The appliance remains in function for a long time period</b>	Bear in mind that during very hot weather and with very high temperatures in the room it is normal that the compressor remains on for prolonged periods of time. Were the doors or drawers open for a long period of time? Were large quantities of food recently inserted? Check that the doors are closed and that the food or containers do not obstruct the perfect closure of the door. Is one or more compartments in Shopping Mode?
<b>If you hear unusual noises</b>	It is normal to hear noises from the ventilators or compressors during operation or during the defrost phase. Noise could be more marked depending on the position of the appliance and the surrounding environment.
<b>Condensation inside and outside of the refrigerator</b>	If the climate is very humid, the formation of condensation is normal. Opening the door or drawers for prolonged periods of time can contribute to the formation of condensation. In any case, make sure that the doors are always perfectly closed.
<b>Ice or frost build up inside the refrigerator or freezer</b>	Did you leave the doors open for a long period of time? Do the doors close perfectly? If the doors do not close perfectly, contact your installer. In case of frost or ice build up in the Crisper-Fresco compartment, due to frequent and prolonged opening of the doors, deactivate the Crisper-Fresco function via the button on the control panel. Wait until the frost or ice melt, then remove the drawer and dry the sides and bottom of the compartment.
<b>Unpleasant odors inside the refrigerator</b>	Clean the appliance completely according to the instructions. Hermetically cover all the food. Do not conserve food for prolonged periods of time.
<b>The doors are difficult to open</b>	The appliance is designed to ensure a fully hermetic closure. When the door is closed, a vacuum condition can occur: in this case it is necessary to wait a few seconds until the pressure balances before opening the door.
<b>Appliance is cooling but lights and display are not working</b>	Check to see if the appliance was accidentally placed into Sabbath Mode

**The Ice Maker does not work**

Make sure that the Ice Maker is on (Icemaker button  on). To switch on the Ice Maker press the button. Make sure that the appliance is connected to the water supply.

**The Ice Maker does not produce sufficient amounts of ice**

On average, the Ice Maker produces approximately 10 cubes of ice every two and half hours.

**The ice cubes freeze into one block**

If the ice is not used frequently, it is possible that blocks of ice may form. It is recommended to remove the block of ice cubes and then let the Ice Maker fill the ice tray again.

**The ice has an unusual flavor or color**



If the unit you purchased was used as a show-room model it may be in a special energy-saving mode called Demo Mode where the appliance appears to be operating (lights work and false temperatures are displayed) but no cooling actually takes place. If you suspect your appliance is in Demo Mode please contact your point of purchase for assistance with disabling this feature.

When the Ice Maker is started for the first time, it is recommended to empty the first full tray of ice cubes. If the refrigerator was switched off for more than one month or if the cartridge was not changed for more than six months, it could be necessary to replace the filter cartridge. Contact a plumber or a water treatment expert to make sure that the problem is not due to the water supply.

## Malfunction indications appearing on the display 12.2

Display message	Malfunction description
<b>Power Failure!!</b>	Prolonged interruption of electrical power the appliance resumes work automatically, the display shows the warmest temperatures achieved
<b>Door Fridge OPEN</b>	Fridge door open the message appears after few minutes from the door opening
<b>TriMode OPEN</b>	Freezer door open the message appears after few minutes from the door opening
<b>Replace filter</b>	Replace filter cartridge message appears when only 30% of filter capacity is left
<b>Fridge too warm</b>	Fridge too warm see Troubleshooting Guide
<b>Fridge too cold</b>	Fridge too cold wait for 12 hours: if malfunction persists call Customer Care for advice
<b>Fresco too warm</b>	Fresco Compartment too warm see Troubleshooting Guide
<b>Fresco too cold</b>	Fresco Compartment too cold wait for 12 hours: if malfunction persists call Customer Care for advice
<b>TriMode too warm</b>	Freezer too warm see Troubleshooting Guide
<b>TriMode too cold</b>	Freezer too cold wait for 12 hours: if malfunction persists call Customer Care for advice
<b>Error Code...</b>	Functional problems call Customer Care who may help you to solve the problem or put you in contact with the nearest Service Agent

## 13 Before calling for service

### 13.1 Before calling for service

If our recommendations were not sufficient to solve the problem, please get in touch with our **Customer Care Center** for further support via our website at

**[www.fhiaba.com](http://www.fhiaba.com)**

or by sending an email to

**[care@fhiaba.com](mailto:care@fhiaba.com)**

You can also contact us on the phone at

**+39 0434 420 160**

If necessary, we will place you in contact with the **Fhiaba Service Center** nearest to you.

Before calling, write down the model type and serial number and any messages which may have appeared on the display.

This information is available on the warranty certificate and on the rating plate which is located on the cabinet's frame, on the bottom left side, behind the bottom drawer.

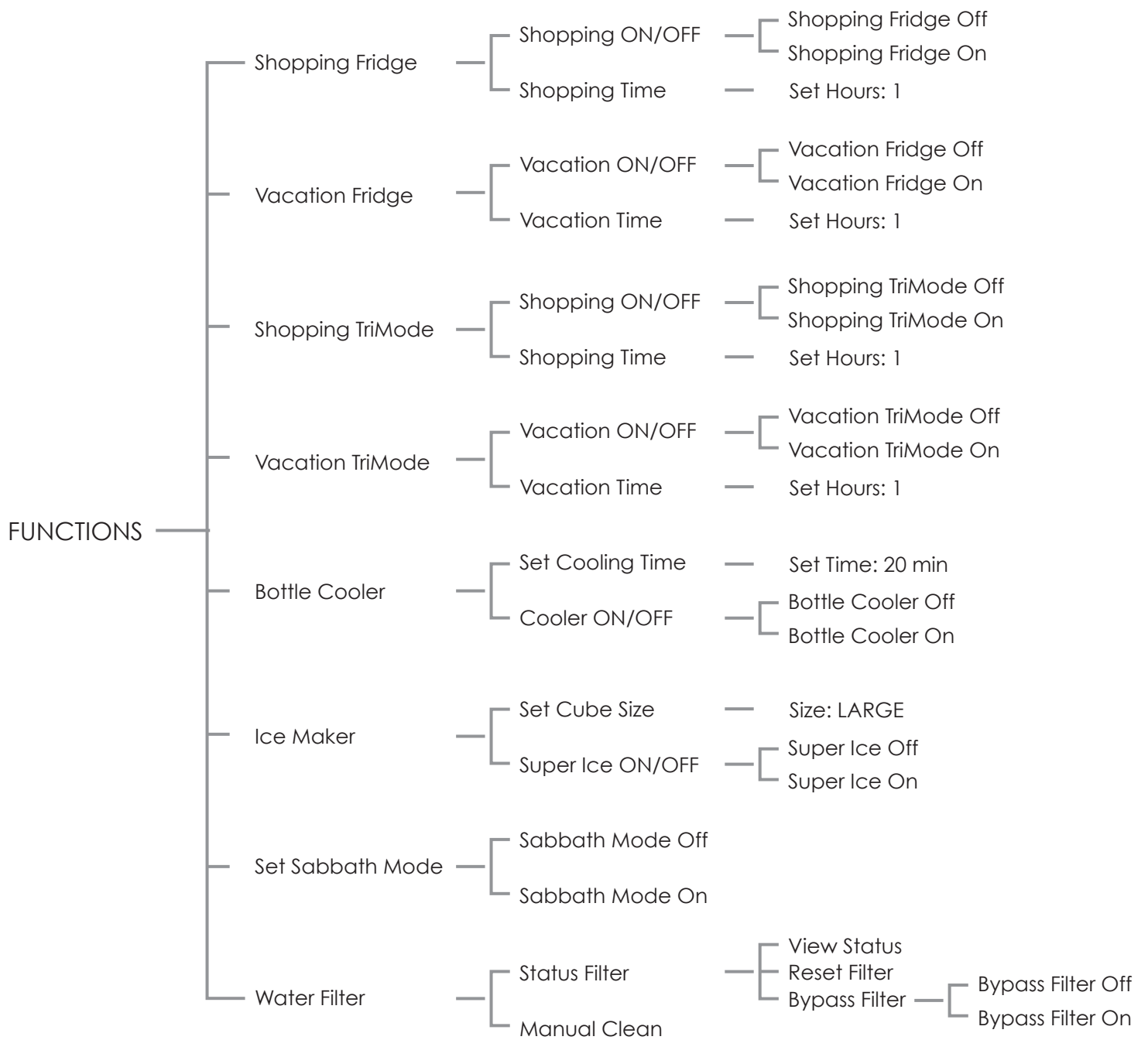

# 14 Fhiaba Access Menu Map

## 14.2 Setting

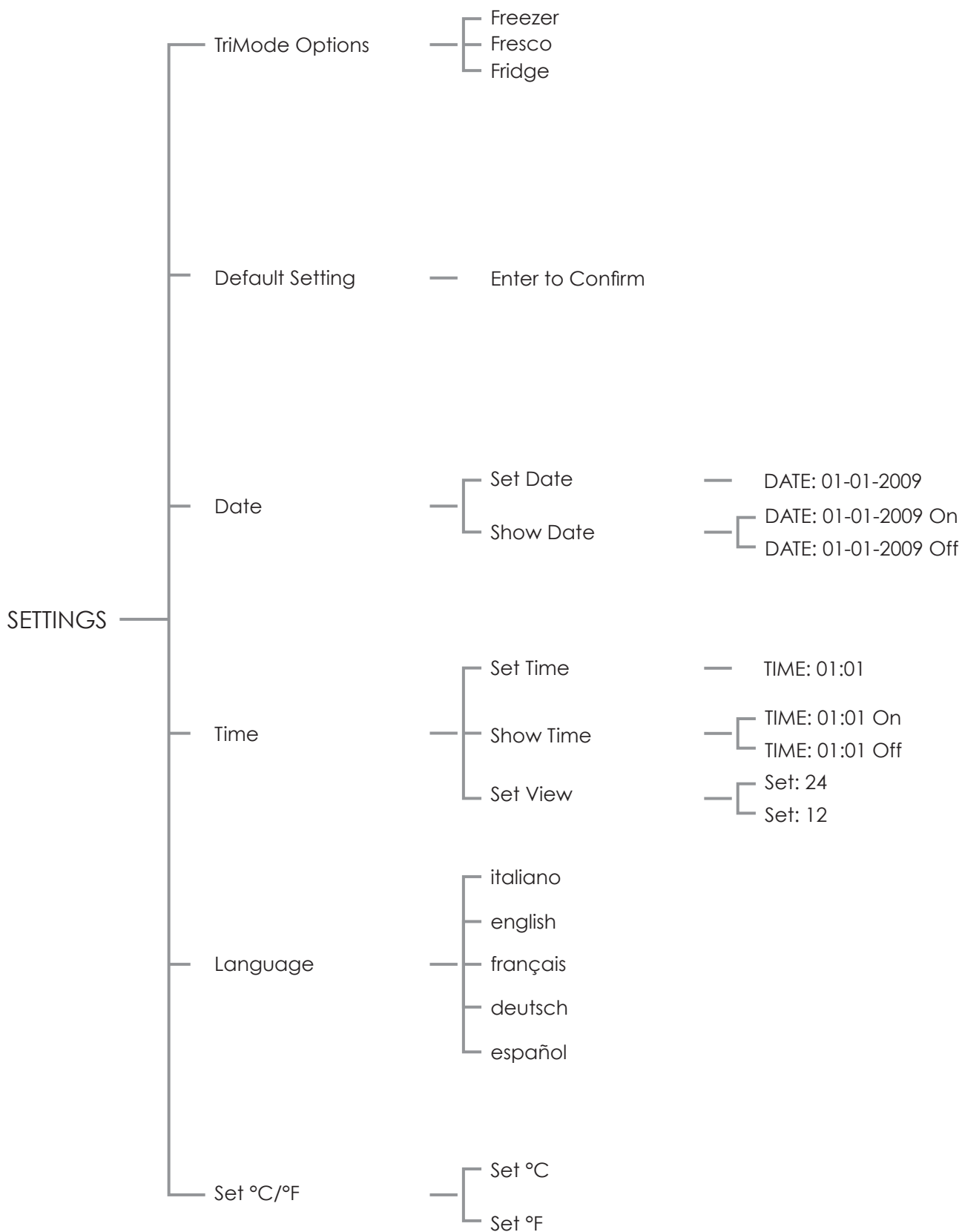

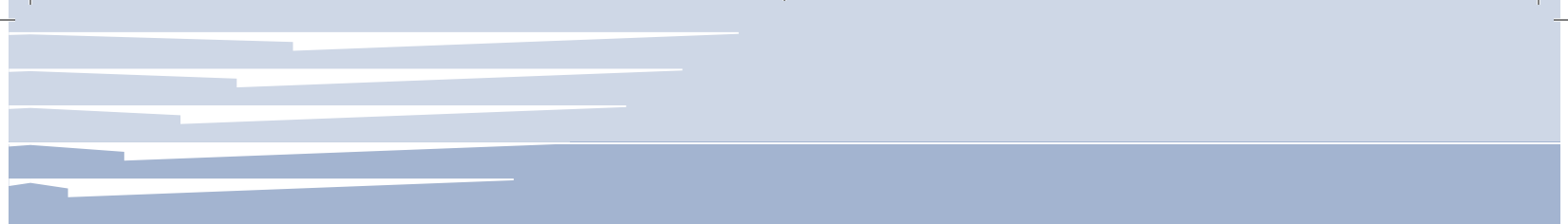

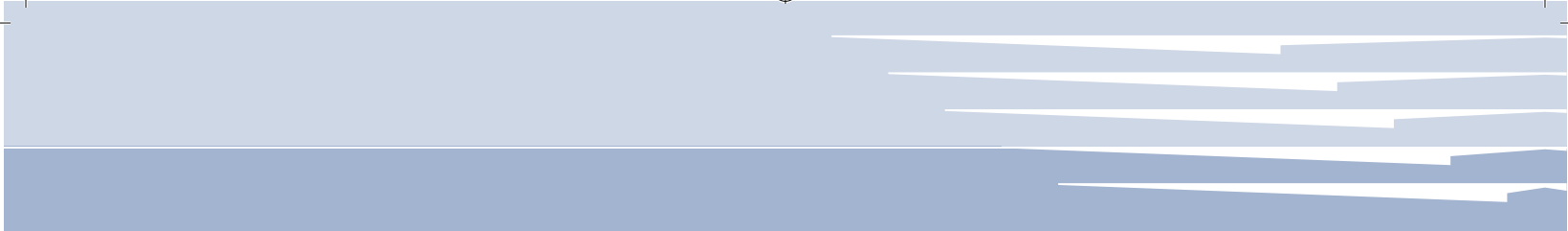

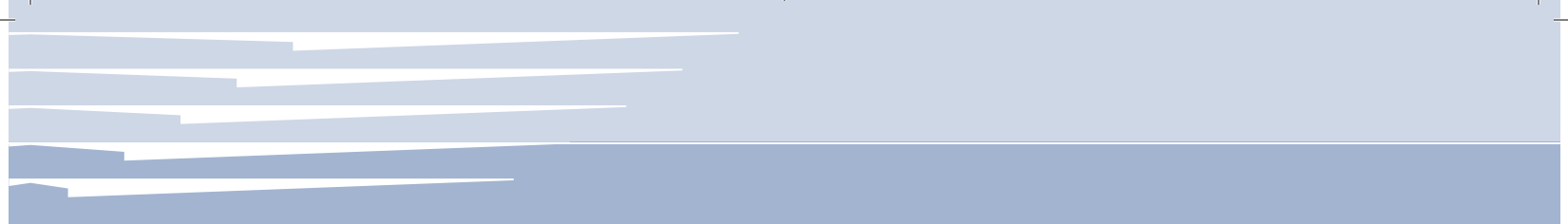

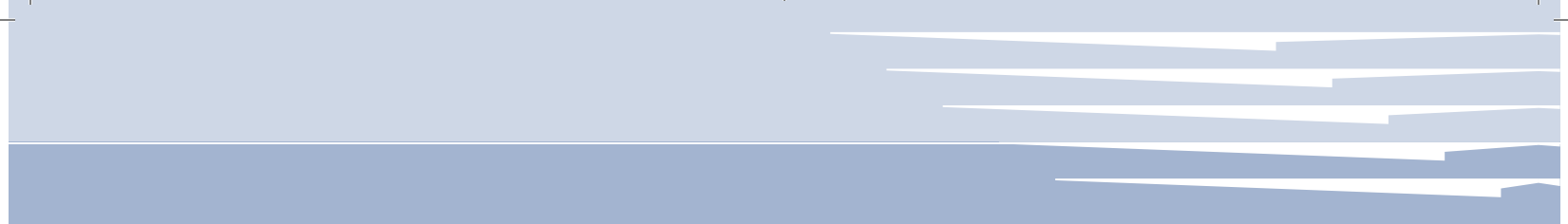

W

11-11-2014



B09000109 EN



[www.fhiaba.com](http://www.fhiaba.com)

Info Line

800 - Fhiaba · (800-344222)