

## Operating and installation instructions Oven



To avoid the risk of accidents or damage to the appliance it is **essential** to read these instructions before it is installed and used for the first time.

# Contents

---

<b>Warning and safety instructions</b> .....	5
<b>Caring for the environment</b> .....	13
<b>Guide to the appliance</b> .....	14
<b>Controls</b> .....	15
On/Off sensor control .....	16
Display .....	16
Sensor controls .....	16
Symbols .....	18
<b>Using the appliance</b> .....	19
Selecting a menu option .....	19
Changing a setting in a list .....	19
Changing the setting with a segment bar .....	19
Selecting a function or operating mode .....	20
Entering numbers .....	20
<b>Features</b> .....	21
Data plate .....	21
Scope of delivery .....	21
Accessories supplied and available to order .....	21
Safety features .....	27
PerfectClean treated surfaces .....	27
<b>Before using for the first time</b> .....	28
Basic settings .....	28
Heating up the oven for the first time .....	29
<b>Settings</b> .....	30
Settings overview .....	30
Opening the “Settings” menu .....	31
Language  .....	31
Time .....	31
Lighting .....	32
Display .....	32
Volume .....	32
Units .....	33
Booster .....	33
Recommended temps. ....	33
Pyrolytic reminder .....	33
Cooling fan run-on .....	33
Safety .....	34
Software version .....	34
Showroom programme .....	34
Factory default .....	34
<b>Min. minder</b> .....	35

<b>Main and sub-menus</b> .....	37
<b>Energy saving tips</b> .....	38
<b>Operation</b> .....	40
Changing values and settings for a cooking programme.....	40
Changing the temperature.....	40
Setting cooking durations .....	41
Changing the set cooking durations .....	41
Deleting the set cooking durations.....	41
Cancelling a cooking programme .....	42
Pre-heating the oven .....	42
Booster.....	42
<b>Automatic programmes</b> .....	43
Categories .....	43
Using automatic programmes.....	43
Handy hints .....	43
<b>Further applications</b> .....	44
Defrost .....	44
Drying .....	45
Low temperature cooking.....	46
Frozen food/Ready meals.....	47
Heat crockery .....	47
<b>Baking</b> .....	48
Tips on baking.....	48
Notes on the cooking charts .....	48
Notes on the functions .....	49
<b>Roasting</b> .....	50
Tips for roasting .....	50
Notes on the cooking charts .....	50
Notes on the functions .....	51
<b>Grilling</b> .....	52
Tips for grilling.....	52
Notes on the cooking charts .....	52
Notes on the functions .....	53
<b>Cleaning and care</b> .....	54
Unsuitable cleaning agents.....	54
Removing normal soiling .....	55
Removing stubborn soiling (excluding the FlexiClip runners) .....	55
Stubborn soiling on the FlexiClip runners .....	56
Pyrolytic cleaning of the oven compartment.....	56
Door removal.....	59
Dismantling the door .....	60

# Contents

---

Fitting the door .....	63
Removing the side runners with FlexiClip runners .....	64
Lowering the top heat/grill element.....	65
<b>Problem solving guide</b> .....	66
<b>Service</b> .....	70
Contact in the event of a fault .....	70
Warranty .....	70
<b>Installation</b> .....	71
Installation dimensions.....	71
Installation in a tall or base unit.....	71
Side view .....	72
Connections and ventilation.....	73
Installing the oven .....	74
Electrical connection .....	75
Oven .....	75
Electrical connection: Other countries .....	76
<b>Cooking charts</b> .....	77
Batter .....	77
Shortcrust pastry.....	78
Yeast dough .....	79
Quark dough.....	80
Sponge mixture .....	80
Choux pastry, puff pastry, meringue.....	81
Savoury dishes .....	82
Beef .....	83
Veal.....	84
Pork .....	85
Lamb, game .....	86
Poultry, fish.....	87
<b>Notes for test institutes</b> .....	88
Test food according to EN 60350-1 .....	88
Energy efficiency class according to EN 60350-1.....	89
Data sheet for household ovens .....	89

## Warning and safety instructions

This oven complies with all current local and national safety requirements. However, inappropriate use can lead to personal injury and damage to property.

Read the operating and installation instructions carefully before using the oven. They contain important information on safety, installation, use and maintenance. This prevents both personal injury and damage to the oven.

In accordance with standard IEC/EN 60335-1, Miele expressly and strongly advises that you read and follow the instructions in the chapter on installing the oven as well as the safety instructions and warnings.

Miele cannot be held liable for damage caused by non-compliance with these instructions.

Keep these instructions in a safe place and pass them on to any future owner.

### Appropriate use

▶ This oven is intended for domestic use and use in other similar environments.

▶ The oven is not intended for outdoor use.

▶ The oven is intended for domestic use only to bake, roast, grill, cook, defrost and dry food.

All other types of use are not permitted.

▶ This oven may only be used by people with reduced physical, sensory or mental capabilities or lack of experience and knowledge if they are supervised whilst using it.

They may only use it unsupervised if they have been shown how to use it in a safe manner. They must be able to recognise and understand the dangers of misuse.

## Warning and safety instructions

---

- ▶ The oven compartment is equipped with special lamps to cope with particular conditions (e.g. temperature, moisture, chemical resistance, abrasion resistance and vibration). These special lamps must only be used for the purpose for which they are intended. They are not suitable for room lighting.
- ▶ The oven contains 1 light source corresponding to energy efficiency class G.

### Safety with children

- ▶ Children under 8 years of age must be kept away from the oven unless they are constantly supervised.
- ▶ Children aged 8 and older may only use the oven without supervision if they have been shown how to use it in a safe manner. Children must be able to understand and recognise the possible dangers caused by incorrect operation.
- ▶ Children must not be allowed to clean or maintain the oven unsupervised.
- ▶ Children should be supervised in the vicinity of the oven. Never allow children to play with the oven.
- ▶ Risk of suffocation due to packaging material. Whilst playing, children may become entangled in packaging material (such as plastic wrapping) or pull it over their head, presenting the risk of suffocation.

Keep packaging material away from children.

- ▶ Risk of injury caused by hot surfaces. Children's skin is far more sensitive to high temperatures than that of adults. External parts of the oven such as the door glass, control panel and the vent become quite hot.

Do not let children touch the oven when it is in operation.

- ▶ Danger of injury caused by hot surfaces. Children's skin is far more sensitive to high temperatures than that of adults. The oven gets much hotter during pyrolytic cleaning than during normal use. Do not let children touch the oven during pyrolytic cleaning.

- ▶ Risk of injury from the open door.

The oven door can support a maximum weight of 15 kg. Children could injure themselves on an open door.

Do not let children sit on the open door, lean against it or swing on it.

### Technical safety

- ▶ Unauthorised installation, maintenance and repairs can cause considerable danger for the user. Installation, maintenance and repairs must only be carried out by a Miele authorised technician.
- ▶ Damage to the oven can compromise your safety. Check the oven for visible signs of damage. Do not use a damaged oven.
- ▶ Temporary or permanent operation on an autonomous power supply system or a power supply system that is not synchronised with the mains power supply (e.g. island networks, back-up systems) is possible. A prerequisite for operation is that the power supply system complies with the specifications of EN 50160 or an equivalent standard.

The function and operation of the protective measures provided in the domestic electrical installation and in this Miele product must also be maintained in isolated operation or in operation that is not synchronised with the mains power supply, or these measures must be replaced by equivalent measures in the installation. As described, for example, in the current version of BS OHSAS 18001–2 ISO 45001.

- ▶ The electrical safety of this oven can only be guaranteed when correctly earthed. It is most important that this basic safety requirement is fulfilled. If in doubt, the electrical installation should be checked by a qualified electrician.
- ▶ The connection data (voltage and frequency) on the data plate of the oven must match the mains electricity supply in order to avoid the risk of damage to the oven. Compare this before connecting the appliance to the mains. If in any doubt, consult a qualified electrician.

## Warning and safety instructions

---



- ▶ Multi-socket adapters and extension leads do not guarantee the required safety of the appliance. Do not use these to connect the oven to the mains electricity supply.
- ▶ For safety reasons, the oven may only be used when it has been fully installed.
- ▶ The oven must not be used in a non-stationary location (e.g. on a ship).
- ▶ Risk of injury due to electric shock. Any contact with live connections or tampering with the electrical or mechanical components of the oven will endanger your safety and may lead to the oven malfunctioning.  
Do not open the oven housing under any circumstances.
- ▶ While the oven is under warranty, repairs should only be undertaken by a Miele authorised service technician. Otherwise the warranty will be invalidated.
- ▶ Miele can only guarantee the safety of the oven when original Miele spare parts are used. Faulty components must only be replaced by original spare parts.
- ▶ If the oven is delivered without a power connection cable, a special cable must be installed by a Miele authorised service technician (see “Installation”, “Electrical connection”).
- ▶ If the connection cable is damaged, it must be replaced with a special connection cable by a Miele authorised service technician (see “Installation”, “Electrical connection”).
- ▶ During installation, maintenance and repair work, e.g. if the oven interior lighting is faulty (see “Problem solving guide”), the oven must be completely disconnected from the household electricity supply. To ensure this, do one of the following:
  - Disconnect the mains fuse
  - Completely unscrew the screw-out fuse (in countries where this is applicable)
  - Pull out the plug (if one is present) at the wall socket To do this, pull the plug and not the mains connection cable.

## Warning and safety instructions

---



- ▶ The oven requires a sufficient supply of cool air for efficient operation. Make sure that the supply of cool air is not hindered in any way (e.g. by fitting heat insulation strips in the housing unit). Furthermore, the required supply of cool air must not be excessively heated by other heat sources (e.g. solid fuel stoves).
- ▶ If the oven is built in behind a furniture front (e.g. a door), do not close the furniture door while the oven is in use. Heat and moisture can build up behind the closed furniture door. This can result in damage to the oven, housing unit and floor. Leave the furniture front/door open until the oven has cooled down completely.

### Correct use

- ▶ Risk of injury caused by hot surfaces. The oven gets hot during operation. You could burn yourself on the heating elements, oven compartment, accessories or food. Wear oven gloves when placing hot food in the oven or removing it and when adjusting oven shelves, for example, in a hot oven compartment.
- ▶ Due to the high temperatures radiated, objects left near the oven could catch fire. Do not use the oven to heat up the room.
- ▶ Oils and fats can ignite if allowed to overheat. Never leave the oven unattended when cooking with oil or fats. Never attempt to put out oil or fat fires with water. Switch the oven off and extinguish the flames by leaving the door closed.
- ▶ Grilling food for excessively long cooking durations can cause it to dry out with the risk of catching fire. Do not exceed the recommended cooking durations.
- ▶ Certain foods dry out quickly and may catch fire due to high grill temperatures. Never use grill modes to finish baking partially baked rolls or bread or to dry flowers or herbs. Instead, use the Fan plus  or Conventional heat  function.

## Warning and safety instructions

---

- ▶ If using alcohol in your recipes, please be aware that high temperatures can cause the alcohol to evaporate. The vapour can catch fire on hot heating elements.
- ▶ When using residual heat to keep food warm, corrosion from high air humidity and condensation can occur in the oven. This can also cause damage to the control panel, worktop and surrounding kitchen furniture. Keep the oven on and select the lowest temperature available for the selected function. The cooling fan will then continue to run automatically.
- ▶ Food which is stored in the oven compartment or left in it to be kept warm can dry out and the moisture released can lead to corrosion damage in the oven. Always cover food that is left in the oven to keep warm.
- ▶ An accumulation of heat can cause the enamel on the oven compartment floor to crack or flake off.  
Never line the floor of the oven compartment with aluminium foil or oven liners.  
If you wish to place crockery on the floor of the oven compartment during cooking, or place crockery on the floor of the oven compartment to heat it up, you can do so, but only with the Fan plus  or Eco Fan heat  function, without the Booster function.
- ▶ The oven compartment floor can become damaged by items being pushed around on it. When placing pots, pans or crockery on the oven compartment floor, ensure that you avoid pushing them around.
- ▶ Risk of injury caused by steam. Pouring a cold liquid onto a hot surface creates steam, which can cause severe scalding. The sudden temperature change can also cause damage to hot enamelled surfaces. Never pour cold liquids directly onto hot enamelled surfaces.

## Warning and safety instructions

---

- ▶ It is important that the temperature in the food being cooked is evenly distributed and sufficiently high. This can be achieved by stirring or turning the food.
- ▶ Plastic dishes that are not suitable for use in an oven will melt and may ignite at high temperatures, and can damage the oven. Use only plastic containers that are suitable for use in an oven. Follow the manufacturer's instructions.
- ▶ Heating up food in closed containers, such as tins or sealed jars, will result in an increase in pressure, which can cause them to explode. Do not heat up unopened tins or jars of food in the oven.
- ▶ Risk of injury from the open door. You could bang into the open door or trip over it. Avoid leaving the door open unnecessarily.
- ▶ The door can support a maximum load of 15 kg. Do not lean or sit on an open door, or place heavy items on it. Make sure that nothing gets trapped between the door and the oven compartment. This could damage the oven.

### **The following applies to stainless steel surfaces:**

- ▶ Adhesives will damage the stainless steel surface and cause it to lose its dirt-repellent protective coating. Do not use sticky notes, adhesive tape or other types of adhesive on the stainless steel surface.
- ▶ Magnets can cause scratches. Do not use the stainless steel surface as a magnetic notice board.

### **Cleaning and care**

- ▶ Risk of injury due to electric shock. The steam from a steam cleaning appliance could reach live electrical components and cause a short circuit. Do not use a steam cleaner to clean the appliance.
- ▶ Scratches on the door glass can cause the glass to break. Do not use abrasive cleaners, hard sponges, brushes or sharp metal tools to clean the door glass.

## Warning and safety instructions

---

- ▶ The side runners can be removed (see “Cleaning and care” – “Removing the side runners with FlexiClip runners”). Refit the side runners correctly.
- ▶ Coarse soiling in the oven compartment can cause thick smoke to develop. Coarse soiling should be removed from the oven compartment before running the pyrolytic cleaning programme.
- ▶ In warm, moist environments, there is a higher probability of pest infestations (such as cockroaches). Ensure the oven and the area surrounding it are always kept clean.  
Damage caused by pests is not covered by the warranty.

### Accessories

- ▶ Only use original Miele accessories. If other parts are used, warranty, performance and product liability claims will be invalidated.
- ▶ Miele will guarantee to supply functional spare parts for a minimum of 10 years and up to 15 years following the discontinuation of your oven.
- ▶ The Miele gourmet oven dish HUB 5000/HUB 5001 (if available) must not be inserted into shelf level 1. This will damage the floor of the oven. The lack of clearance will create an accumulation of heat which can cause the enamel to crack or flake off. Never place a Miele oven dish on the upper support of shelf level 1 either as it will not be secured by the non-tip safety notches. As a general rule, use shelf level 2.
- ▶ Remove all accessories as well as the runners and any extra accessories such as FlexiClip runners from the oven interior before starting the Pyrolytic cleaning programme.  
The high temperatures needed for pyrolysis will damage them.

### Disposing of the packaging material

The packaging material is used for handling and protects the appliance from transport damage. The packaging material used is selected from materials which are environmentally friendly for disposal and can generally be recycled.

Recycling the packaging material reduces the use of raw materials. Use material-specific collection points for valuable materials and take advantage of return options. Your Miele dealer will take the packaging material away.

### Disposing of your old appliance

Electrical and electronic appliances contain many valuable materials. They also contain certain materials, compounds and components which were essential for their correct functioning and safety. These could be hazardous to human health and to the environment if disposed of with household waste or if handled incorrectly. Please do not, therefore, dispose of your old appliance with household waste.



Instead, please make use of officially designated collection and disposal points to dispose of and recycle electrical and electronic appliances in your local community, with your dealer or with Miele, free of charge. By law, you are solely responsible for deleting any personal data from the old appliance prior to disposal. You are legally obliged to remove any old batteries which are not securely enclosed by the appliance and to remove any lamps without destroying them, where this is possible. These must be taken to a suitable collection point where they can be handed in free of charge. Please ensure that your old appliance poses no risk to children while being stored for disposal.





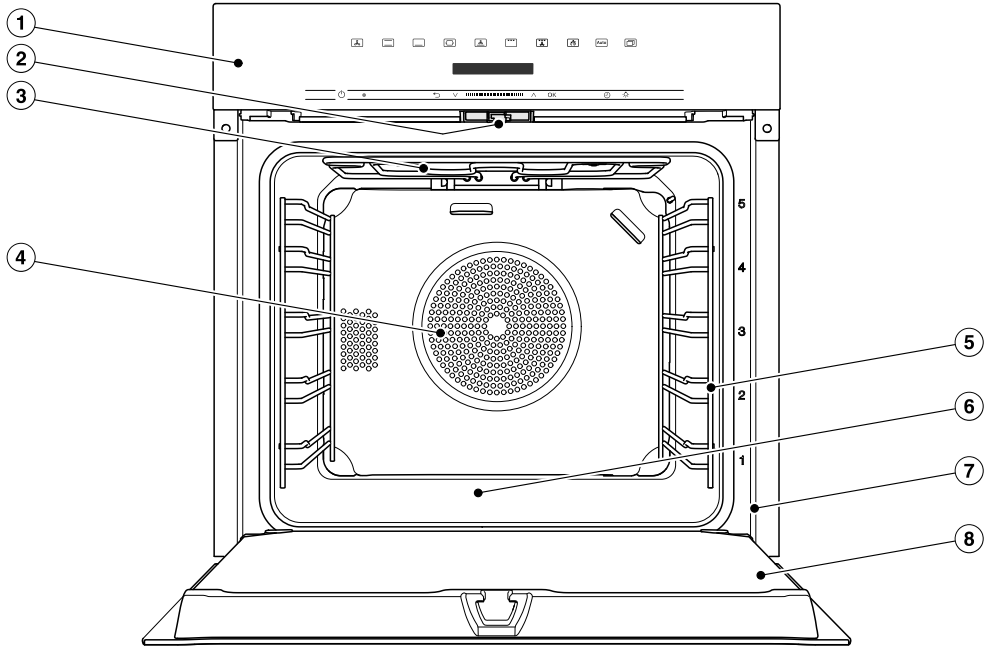

# Guide to the appliance

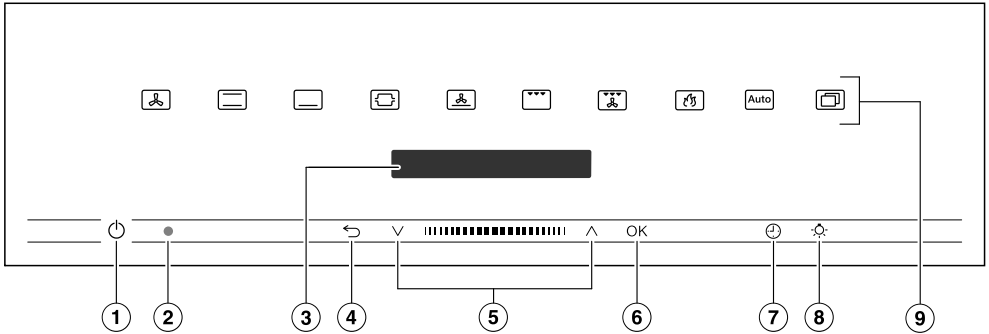
## Oven



- ① Control elements
- ② Door lock
- ③ Top heat/grill element
- ④ Air inlet for the fan with ring heating element behind it
- ⑤ Side runners with 5 shelf levels
- ⑥ Oven floor with bottom heat element underneath it
- ⑦ Front frame with data plate
- ⑧ Door



- ① Recessed  On/Off sensor control  
For switching the oven on and off
- ② Optical interface  
(For Miele Service only)
- ③ Display  
For displaying the time of day and information on operation
- ④  sensor control  
For going back a step and cancelling a cooking programme
- ⑤ Navigation area with  and  arrow buttons  
For scrolling through lists and for changing values
- ⑥ *OK* sensor control  
For selecting functions and saving settings
- ⑦  sensor control  
For setting a minute minder, the cooking duration or the start or end time for the cooking programme
- ⑧  sensor control  
For switching the oven interior lighting on and off
- ⑨ Sensor controls  
For selecting functions, automatic programmes and settings

# Controls

---

## On/Off sensor control

The  On/Off sensor control is recessed and reacts to touch.

Use this sensor control to switch the oven on and off.

## Display

The display is used for showing the time of day or information about functions, temperatures, cooking durations, automatic programmes and settings.

After switching the oven on with the  On/Off sensor control, Select function will appear in the main menu.

## Sensor controls





The sensor controls react to touch. Every touch of a sensor is confirmed with an audible keypad tone. You can turn this keypad tone off using Further  | Settings | Volume | Keypad tone.

If you want the sensor controls to respond even when the oven is switched off, select the Display | QuickTouch | On setting.

## Sensor controls above the display

For information on the functions and operating modes, see “Main and sub-menus”, “Settings”, “Automatic programmes” and “Further applications”.

## Sensor controls under the display

Sensor control	Function
	<p>Depending on which menu you are in, this sensor control will take you back a level or back to the main menu.</p> <p>If a cooking programme is in progress at the same time, use this sensor control to cancel the programme.</p>
	<p>In the navigation area, use the arrow buttons or the area between them to scroll up or down in the selection lists. The display shows the menu option that you want to select.</p> <p>You can change the values and settings using the arrow buttons or the area between them.</p>
<i>OK</i>	<p>As soon as you reach a confirmable value, message or setting, the <i>OK</i> sensor control will light up orange.</p> <p>By selecting this sensor control you can access functions such as the minute minder, save changes to values or settings or confirm instructions.</p>
	<p>If no cooking programme is in progress, you can use this sensor control to set a minute minder (e.g. when boiling eggs) at any point.</p> <p>If a cooking programme is in progress at the same time, you can set a minute minder, the cooking duration and a start or end time for the programme.</p>
	<p>Select this sensor control to switch the oven interior lighting on and off.</p> <p>Depending on the setting selected, the oven interior lighting switches off after 15 seconds or remains constantly switched on or off.</p>

# Controls

---

## Symbols

The following symbols may appear in the display:

Symbol	Meaning
	This symbol indicates that there is additional information and advice about using the appliance. Press the <i>OK</i> sensor control to confirm the information.
	Minute minder
	A tick indicates the option which is currently selected.
	Some settings, e.g. display brightness and buzzer volume are selected using a bar chart.
	The system lock prevents the oven being switched on by mistake (see “Settings – Safety”).

Use the  $\wedge$  and  $\vee$  arrow buttons or the **|||||** area between them in the navigation area to use the oven.

As soon as you reach a confirmable value, message or setting, the *OK* sensor control will light up orange.

## Selecting a menu option

- Touch the  $\wedge$  or  $\vee$  arrow buttons or swipe to the right or left in the **|||||** area until you reach the desired menu option.

**Tip:** If you press and hold an arrow button, the list continues scrolling automatically until you release the arrow button.

- Confirm your selection with *OK*.

## Changing a setting in a list

A  $\checkmark$  tick will appear beside the current setting.

- Touch the  $\wedge$  or  $\vee$  arrow buttons or swipe to the right or left in the **|||||** area until you reach the desired value or setting.
- Confirm with *OK*.

The setting is now saved. This will take you back to the previous menu.

## Changing the setting with a segment bar

Some settings are represented by a bar **■■■■■□□□** with seven segments. If all of the segments are illuminated, the maximum value is selected.

If none of the segments are illuminated, or only one of them is, the minimum value is selected or the setting is switched off altogether (e.g. volume).

- Touch the  $\wedge$  or  $\vee$  arrow buttons or swipe to the right or left in the **|||||** area until you reach the desired setting.
- Confirm your selection with *OK*.

The setting is now saved. This will take you back to the previous menu.

# Using the appliance

---

## Selecting a function or operating mode

The sensor controls for the functions and operating modes (e.g. Further ) are located above the display (see “Controls” and “Settings”).

- Touch the sensor control for the desired function.

The sensor control on the fascia panel lights up orange.

- For functions and operating modes: set values such as the temperature.
- Under Further : scroll through the lists until you reach the desired menu option.
- Confirm with *OK*.

## Changing the function

You can change to another function during a cooking programme.

The sensor control for the previously selected function lights up orange.

- Touch the sensor control of the new function or operating mode.

The new function appears in the display with its corresponding recommended values.

The sensor control for the new function lights up orange.

Under Further , scroll through the lists until you reach the desired menu option.

## Entering numbers

Numbers that can be changed are highlighted.

- Touch the  $\wedge$  or  $\vee$  arrow buttons or swipe to the right or left in the **|||||** area until the desired number is highlighted.

**Tip:** If you press and hold an arrow button, the numbers continue scrolling automatically until you release the arrow button.

- Confirm with *OK*.

The changed number is now saved. This will take you back to the previous menu.

A list of the models described in these operating and installation instructions can be found on the back page of this booklet.

## Data plate

The data plate is located on the front frame, visible when the door is open.

The data plate states the model number, the serial number as well as connection data (voltage, frequency and maximum rated load).

Please have this information to hand, should you need to contact Miele regarding any questions or problems.

## Scope of delivery

- Operating and installation instructions for using the oven
- A cookbook with recipes for the automatic programmes and other functions
- Screws for securing your oven in the housing unit
- Various accessories

## Accessories supplied and available to order

Features will vary depending on model.

Side runners, universal tray and wire rack (or “rack” for short) are supplied as standard with the oven.

Depending on the model, your oven may also come supplied with some of the accessories listed here.

All the accessories listed as well as the cleaning and care products are designed for Miele ovens.

These are available to order via the Miele Webshop, the Miele Customer Service Department or from your Miele dealer.

When ordering, please quote the model identifier of your oven and the reference number of the accessories required.

### Side runners

There are runners on the left and right of the oven compartment with shelves  for inserting accessories.

The numbers for the shelf levels are marked on the front frame.

Each level consists of 2 rails, one above the other.

The accessories (e.g. the rack) are pushed into the oven between the two rails.

You can remove the side runners (see “Cleaning and care” – “Removing the side runners with FlexiClip runners”).

# Features

## Baking tray, universal tray and rack with non-tip notches

Baking tray HBB 71:

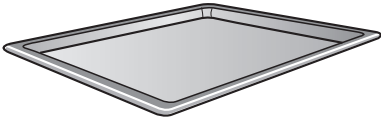

Universal tray HUBB 71:

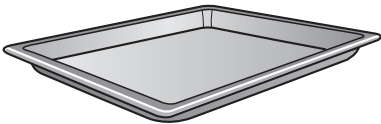

Rack HBBR 71:

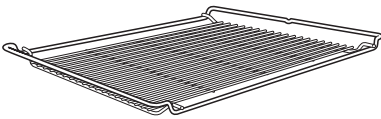

These accessories are inserted into the oven between the two rails of a shelf in the side runner.

Always place the rack with the loading surface in the lower position.

These accessories have non-tip safety notches fitted in the middle of their short sides. The non-tip safety notches prevent the trays from being pulled out completely from the side runners when you only wish to pull accessories out partially.



If you are using the universal tray with the rack on top, insert the tray between the rails of a shelf of the side runners and the rack will automatically slide in above them.

## FlexiClip runners HFC 70-C

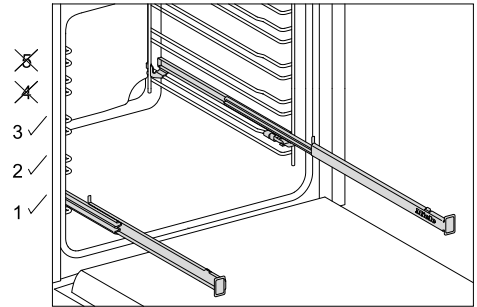

FlexiClip runners can only be fitted on levels 1, 2 and 3.

The FlexiClip runners can be drawn right out of the oven individually to give a good overview of cooking in progress.

Push the FlexiClip runners right into the oven compartment before placing accessories on them.

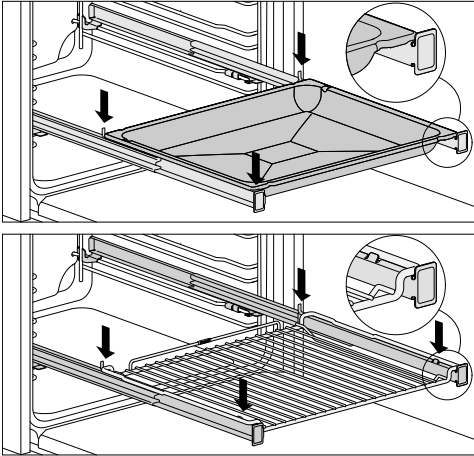

To prevent the risk of accessories sliding off the runners:

- Make sure that they are sitting securely on their runners in between the stoppers at either end of each runner.
- Always place the rack with the loading surface in the lower position on the FlexiClip runners.

The FlexiClip runners can support a maximum load of 15 kg.

Because the FlexiClip runners sit on the top rail of the side runners, the gap between the level the FlexiClip runners are on and the one above is smaller than if, for instance, racks were fitted on each level. Cooking results will be affected if the gap is too small.

You can use more than one baking tray, universal tray or rack at a time.

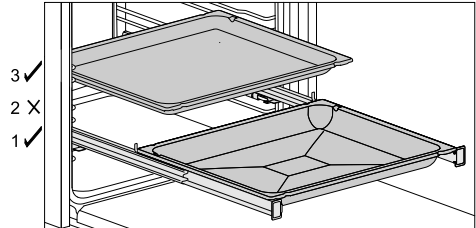

- Place the baking tray, universal tray or rack on the FlexiClip runners.
- Leave at least one shelf level free between the FlexiClip runner and any baking tray, universal tray or rack above it.

You can use the universal tray together with the rack on the FlexiClip runners.

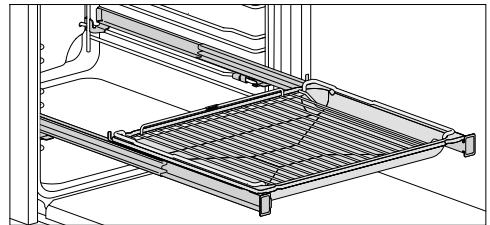

- Place the universal tray together with the rack on the FlexiClip runners. The rack will automatically slide between the rails of the shelf level above the FlexiClip runners.
- Leave at least one shelf level free between the FlexiClip runner and any baking tray, universal tray or rack above it.

# Features

## Fitting the FlexiClip runners

⚠ Risk of injury caused by hot surfaces.

The oven gets hot during operation. You could burn yourself on the heating elements, oven compartment or accessories.

Allow the heating elements, oven compartment and the accessories to cool before fitting or removing the FlexiClip runners.

Preferably fit the FlexiClip runners onto level 1. You can then use them for food which should be cooked on level 2.

One level of the side runners consists of two rails. The FlexiClip runners are fitted on the upper rail of the two rails that make up a shelf level.

The FlexiClip runner with the Miele logo is fitted on the right.

When fitting or removing the FlexiClip runners, **do not** extend them.

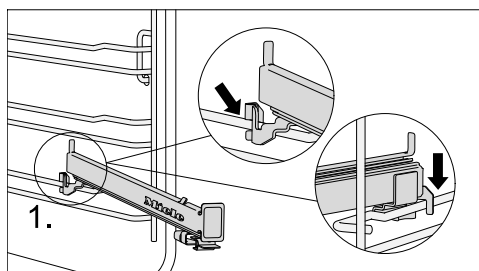

- Hook the FlexiClip runner onto the front of the top rail of a side runner (1.).

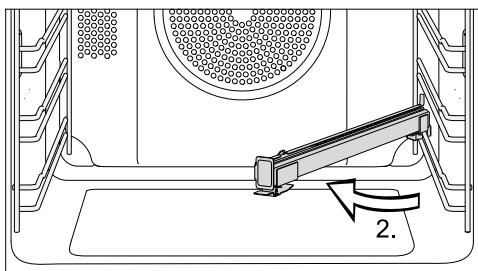

- Then hold the FlexiClip runner at an angle towards the middle of the oven compartment (2.).

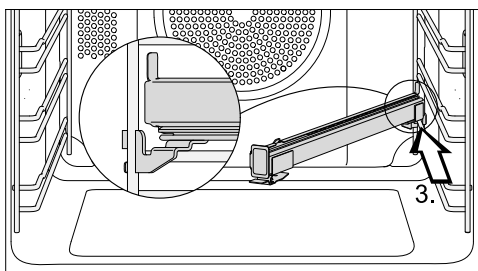

- Slide the FlexiClip runner at an angle along the top rail as far as it will go (3.).

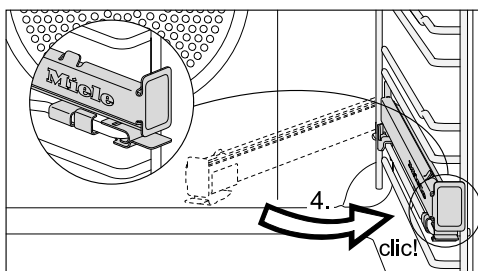

- Then swing the FlexiClip runner back to the side of the oven compartment and secure it to the top rail with an audible click (4.).

If the FlexiClip runners are difficult to pull out after fitting, you may need to pull firmly on them once to release them.

## Removing the FlexiClip runners

 Risk of injury caused by hot surfaces.

The oven gets hot during operation. You could burn yourself on the heating elements, oven compartment or accessories.

Allow the heating elements, oven compartment and the accessories to cool before fitting or removing the FlexiClip runners.

- Push the FlexiClip runner in all the way.

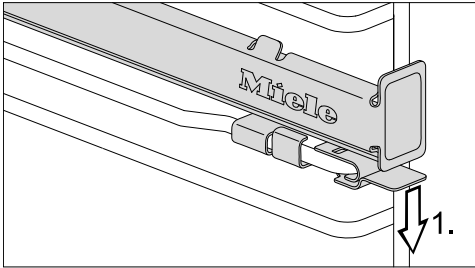

- Push down on the tab at the front of the FlexiClip runner (1.).

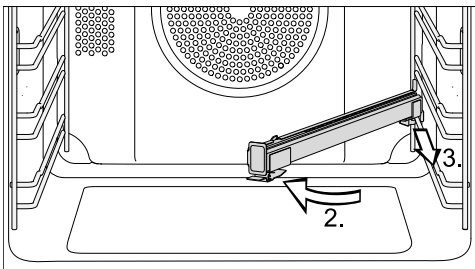

- Swing the FlexiClip runner towards the middle of the oven compartment (2.), then pull it forwards along the top rail (3.).
- Lift the FlexiClip runner off the rail and take it out of the oven.

## Round baking trays



The **solid round baking tray HBF 27-1** is suitable for cooking pizzas, flat cakes made with yeast or whisked mixtures, sweet and savoury tarts, baked desserts, flat bread, and can also be used for frozen cakes and pizzas.

The **perforated round baking tray HBFP 27-1** has been specially developed for baked goods made from fresh yeast and quark dough and for baking bread and rolls. The tiny perforations assist in browning the underside of baked goods. The tray can also be used for dehydrating or drying food.

The enamelled surface of both baking trays has been treated with PerfectClean.

- Insert the rack and place the round baking tray on the rack.

## Grilling and roasting insert HGBB 71

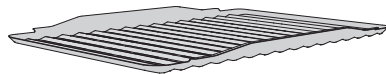

The grilling and roasting insert fits in the universal tray.

The juices from the food being grilled or roasted collect under the insert, preventing them from burning on. The juices can then be used for making gravy and sauces.

The enamelled surface has been treated with PerfectClean.

# Features

## Perforated gourmet baking tray HBBL 71

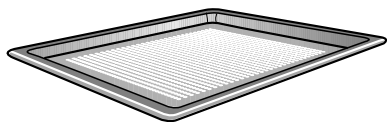

The perforated gourmet baking tray has been specially developed for the preparation of baked goods made from fresh yeast and quark doughs, as well as bread and bread rolls.

The tiny perforations assist in browning the underside of baked goods.

The gourmet baking tray can also be used for dehydrating or drying food.

The enamelled surface has been treated with PerfectClean.

The **round perforated baking tray HBFP 27-1** can be used for the same things.

## Baking stone HBS 70



The baking stone is ideal for items which need a well baked base such as pizza, quiche, bread, bread rolls and savoury snacks.

The baking stone is made from heat-retaining fireclay and is glazed. A paddle made of untreated wood is supplied with the baking stone for placing food on it and taking it off.

- Slide the rack in and place the baking stone on it.

## HUB gourmet oven dishes HBD gourmet oven dish lids

Unlike other oven dishes, Miele gourmet oven dishes can be placed in the oven directly on the shelf runners. They have non-tip safety notches like the rack to prevent them from being pulled out too far.

The surface of the oven dish has a non-stick coating.

Gourmet oven dishes are available in different depths. The width and the height are the same.

Suitable lids are available separately. Please quote the model number when ordering.

### Depth: 22 cm

HUB 5000-M  
HUB 5001-M\*

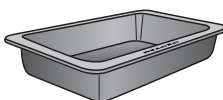

HBD 60-22

### Depth: 35 cm

HUB 5001-XL\*

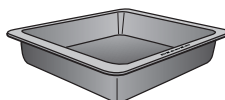

HBD 60-35

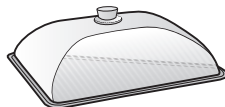
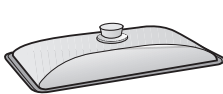

\* Suitable for use on induction hobs

## Handle HEG

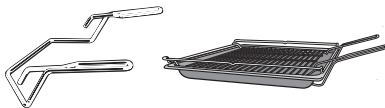

The handle makes it easier to take the universal tray, baking tray and rack out of the oven.

## Accessories for cleaning and care

- Miele all-purpose microfibre cloth
- Miele oven cleaner

## Safety features

- **System lock**   
(see “Settings – Safety”)
- **Sensor lock**  
(see “Settings – Safety”)
- **Cooling fan**  
(see “Settings – Cooling fan run-on”)
- **Safety switch-off**  
This safety switch-off is activated automatically if the oven has been operating for an unusually long period of time. The period of time will depend on the particular oven function being used.
- **Ventilated door**  
The oven door is made of glass panes that have a heat-reflective coating on part of their surface. When the oven is operating, air is passed through the door to keep the outer pane cool.  
The door can be removed and disassembled for cleaning purposes (see “Cleaning and care”).
- **Door locking** for pyrolytic cleaning  
At the beginning of a pyrolytic cleaning programme the door will lock for safety reasons. The door will only be unlocked when the temperature in the oven compartment has dropped to below 280 °C.

## PerfectClean treated surfaces

PerfectClean surfaces have very good non-stick properties and are exceptionally easy to clean.

Food can be easily removed from these surfaces. Soiling from baking and roasting can be easily removed from these surfaces.

Food can be sliced or cut up on PerfectClean surfaces.

However, do not use ceramic knives as these will scratch the PerfectClean surface.

Surfaces treated with PerfectClean enamel can be cleaned as you would clean glass.

Read the instructions in “Cleaning and care” so that the benefits of the non-stick properties and easy cleaning are retained.

PerfectClean treated surfaces:

- Side runners
- Rack
- Universal tray
- Baking tray
- Grilling and roasting insert
- Perforated gourmet baking tray
- Round perforated baking tray
- Round baking tray

# Before using for the first time

---

## Basic settings

The following settings must be made before starting up for the first time. You can change these settings again at a later time (see “Settings”).

 Risk of injury caused by hot surfaces.

The oven gets hot during operation. For safety reasons, the oven may only be used when it has been fully installed.

The oven will switch on automatically when it is connected to the electricity supply.

## Setting the language

- Select the desired language.

If you have selected the wrong language by mistake, proceed as described in “Settings –  Language”.

## Setting the location

- Select the required location.

## Setting the time

- Set the time of day in hours and minutes.
- Confirm with *OK*.

## Completing the commissioning process

- Follow any further instructions in the display.

The oven is now ready for use.

## Before using for the first time

### Heating up the oven for the first time

When the oven is heated up for the first time it may give off a slight smell. This can be eliminated by heating the oven for at least an hour.

It is important to ensure that the kitchen is well ventilated during this operation. Prevent the odour from escaping into other rooms.

- Remove any protective wrapping and stickers from the oven and accessories.
- Before heating the oven up, wipe the oven compartment with a damp cloth to remove any dust or bits of packaging that may have accumulated inside during storage and unpacking.
- Fit the FlexiClip runners (if present) to the side runners and insert all trays and the rack.
- Turn the oven on using the On/Off  sensor control.

Select function **appears**.

- Select Fan plus .

The recommended temperature will appear (160 °C).

The oven heating, lighting and cooling fan will switch on.

- Set the maximum possible temperature (250 °C).
- Confirm with *OK*.

Heat the oven for at least an hour.

- After at least an hour, switch the oven off with the On/Off  sensor control.

### Cleaning the oven compartment after heating it up for the first time

 Danger of injury caused by hot surfaces.

The oven gets hot during operation. You could burn yourself on the heating elements, oven compartment or accessories.







Allow the heating elements, oven compartment and the accessories to cool before manual cleaning.

- Take all accessories out of the oven compartment and clean them by hand (see “Cleaning and care”).
- Clean the oven compartment with a clean sponge and a solution of hot water and washing-up liquid or a clean, damp microfibre cloth.
- Dry all surfaces with a soft cloth.

Leave the oven door open until the oven compartment is completely dry.

# Settings

## Settings overview

Menu option	Available settings
Language 	...   deutsch   english   ... Location
Time	Display On*   Off   Night dimming Clock format 12 h   24 h* Set
Lighting	On "On" for 15 seconds* Off
Display	Brightness  QuickTouch On   Off*
Volume	Buzzer tones Melodies*  Solo tone  Keypad tone  Welcome melody On*   Off
Units	Temperature °C*   °F
Booster	On *   Off
Recommended temps.	
Pyrolytic reminder	On *   Off
Cooling fan run-on	Temperature controlled* Time controlled
Safety	Sensor lock On   Off* System lock  On   Off*
Software version	
Showroom programme	Demo mode On   Off*
Factory default	Appliance settings Recommended temps.

\* Factory default setting

## Opening the “Settings” menu

In the Further  | Settings menu, you can personalise your oven by adapting the factory default settings to suit your requirements.

- Select Further .
- Select Settings .
- Select the desired setting.



You can check settings or change them.

Settings cannot be changed while a cooking process is in progress.

## Language

You can set your language and location.

After selecting and confirming your choice, the language you have selected will appear in the display.

**Tip:** If you have selected the wrong language by mistake, select the  sensor control. Follow the  symbol to get back to the Language  sub-menu.

## Time

### Display

Select how you want the time of day to show in the display when the oven is switched off:

- On  
The time is always visible in the display. If you also select the Display | QuickTouch | On setting, all sensor controls react to touch as normal. If you also select the Display | QuickTouch | Off setting, the oven has to be switched on before it can be used.
- Off  
To save energy, the display does not light up. The oven has to be switched on before it can be used.
- Night dimming  
To save energy, the time only shows in the display between 05:00 a.m. and 11:00 p.m. The display remains dark at all other times.

### Clock format

The time of day can be displayed in the 24 or 12-hour format (24 h or 12 h).

### Set



Set the hours and the minutes.

If there is a power cut, the current time of day will reappear once power has been restored. The time of day is saved for approx. 150 hours.

# Settings

---

## Lighting

- On  
The oven interior lighting is switched on during the entire cooking period.
- "On" for 15 seconds  
The oven interior lighting switches off 15 seconds after a cooking programme has begun. Press the  sensor control to switch the oven interior lighting on again for 15 seconds.
- Off  
The oven interior lighting is switched off. Press the  sensor control to switch on the oven interior lighting for 15 seconds.

## Display

### Brightness

The display brightness is represented by a bar with seven segments.

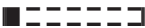
-   
Maximum brightness
-   
Minimum brightness

### QuickTouch

Select how the sensor controls should respond when the oven is switched off:

- On  
If you have also selected the Time | Display | On or Night dimming setting, the sensor controls will also respond when the oven is switched off.
- Off  
Independently of the Time | Display setting, the sensor controls only respond when the oven is switched on, as well as for a certain amount of time after switching it off.

## Volume

### Buzzer tones

If buzzers are switched on, a buzzer will sound when the set temperature is reached and at the end of a set time.

### Melodies

At the end of a process, a melody will sound several times in intervals.

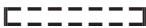

The volume of the melody is represented by a bar with seven segments.

-   
Maximum volume
-   
Melody is switched off

### Solo tone

At the end of a process, a continuous tone will sound for a period of time.

The pitch of this continuous tone is represented by a segment bar.

-   
Maximum pitch
-   
Minimum pitch

### Keypad tone

The volume of the tone that sounds each time you touch a sensor control is represented by a bar with seven segments.

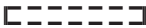
-   
Maximum volume
-   
Tone is switched off

### Welcome melody

The melody that sounds when you touch the  On/Off sensor control can be switched on or off.

## Units

### Temperature

You can set the temperature in degrees Celsius (°C) or degrees Fahrenheit (°F).

### Booster

The **Booster** function is used to quickly pre-heat the oven compartment.

- On  
The **Booster** function is automatically switched on during the heating-up phase of a cooking programme. The top heat/grill element, ring heating element and hot air fan pre-heat the oven compartment to the set temperature at the same time.
- Off  
The **Booster** function is switched off during the heating-up phase of a cooking programme. Only the heating elements for the selected oven function are used to pre-heat the oven compartment.

### Recommended temps.

If you often cook with different temperatures, it makes sense to change the recommended temperatures.

After selecting this menu option, the list of operating modes will appear in the display together with their recommended temperatures.

- Select the relevant operating mode.
- Change the recommended temperatures.
- Confirm with *OK*.

### Pyrolytic reminder

You can set whether you want a reminder to run the pyrolytic cleaning programme to come on (On) or not (Off).

### Cooling fan run-on

The cooling fan will continue to run for a while after the oven has been switched off to prevent any humidity building up in the oven compartment, on the fascia panel or on the oven housing unit.

- Temperature controlled  
The cooling fan switches off when the temperature in the oven drops below 70 °C.
- Time controlled  
The cooling fan switches off after a period of about 25 minutes.

Condensate can damage the oven housing unit and the worktop and lead to corrosion in the oven. If you have set the cooling fan to *Time controlled* and leave food in the oven compartment to keep warm, moisture levels in the oven will increase, leading to condensation forming on the fascia panel and surrounding kitchen furniture, and drops of moisture collecting under the worktop. Do not leave food in the oven compartment to keep it warm if you have selected *Time controlled*.

# Settings

---

## Safety

### Sensor lock

The sensor lock prevents the cooking programme being switched off by mistake or settings being changed. Apart from the  On/Off sensor control, the activated sensor lock prevents the sensor controls and fields in the display from working a few seconds after a programme has been started.

- On  
The sensor lock is activated. Touch the *OK* sensor control for at least 6 seconds to deactivate the sensor lock for a short period of time.
- Off  
The sensor lock is deactivated. All sensor controls react to touch as normal.

### System lock

The system lock prevents the oven being switched on by mistake.

The minute minder can still be used when the system lock is active.

The system lock will remain activated even after a mains outage.

- On  
The system lock has been activated. Before you can use the oven, touch the *OK* sensor control for at least 6 seconds.
- Off  
The system lock is deactivated. You can use the oven as normal.

## Software version

The software version is intended for the Miele Customer Service Department. You do not need this information for domestic use.

## Showroom programme

This function enables the oven to be demonstrated in showrooms without heating up. This setting is not needed for domestic use.

## Demo mode

If you have demo mode activated, Demo mode active. The appliance will not heat up will appear when you switch the oven on.

- On  
Touch the *OK* sensor control for at least 4 seconds to activate demo mode.
- Off  
Touch the *OK* sensor control for at least 4 seconds to deactivate demo mode. You can use the oven as normal.

## Factory default

- Appliance settings  
Any settings that have been altered will be reset to the factory default settings.
- Recommended temps.  
Any recommended temperatures that have been changed will be reset to the factory default settings.

## Using the Min. minder function

The  minute minder can be used to time other activities in the kitchen, e.g. boiling eggs.

The minute minder can also be used at the same time as a cooking programme for which the cooking duration start and finish times have been set (e.g. as a reminder to stir the food or add seasoning, etc.).

- The maximum minute minder time that can be set is 59 minutes and 59 seconds.

**Tip:** When using a function that uses moisture, use the timer to remind you to inject steam manually at the desired time.

## Setting the minute minder

If you have selected the Display | QuickTouch | Off setting, you will need to switch the oven on before setting the minute minder. The minute minder can then be seen counting down in the display when the oven is switched off.

Example: you want to boil some eggs and set a minute minder duration of 6 minutes and 20 seconds.

- Select the  sensor control.
- Select Min. minder if a cooking programme is in progress at the same time.

The prompt Set 00:00 min appears.

- Using the navigation area, set 06:20.
- Confirm with OK.

The minute minder duration is now saved.

When the oven is switched off, the minute minder time counts down in the display and  appears instead of the time of day.

If you are cooking at the same time **without** a set cooking duration,  and the minute minder time appear as soon as the selected temperature is reached.

If you are cooking at the same time **with** a set cooking duration, the minute minder counts down in the background as the cooking duration appears first in the display.

If you are in a menu, the minute minder counts down in the background.

At the end of the minute minder time,  will flash, the time will start counting up and a buzzer will sound.

- Select the  sensor control.
- If required, confirm with OK.

The buzzer will stop and the symbols in the display will go out.

# Min. minder

---

## Changing the minute minder duration

- Select the ⌚ sensor control.
- Select Min. minder if a cooking programme is in progress at the same time.
- Select Change.
- Confirm with *OK*.

The minute minder duration selected appears.

- Change the duration set for the minute minder.
- Confirm with *OK*.











The altered minute minder duration is now saved.

## Deleting the minute minder duration

- Select the ⌚ sensor control.
- Select Min. minder if a cooking programme is in progress at the same time.
- Select Delete.
- Confirm with *OK*.

The minute minder duration is now deleted.





## Main and sub-menus

Menu	Recommended value	Range
Oven functions		
Fan plus 	160 °C	30–250 °C
Conventional heat 	180 °C	30–280 °C
Bottom heat 	190 °C	100–280 °C
Auto roast 	160 °C	100–230 °C
Intensive bake 	170 °C	50–250 °C
Full grill 	240 °C	200–300 °C
Fan grill 	200 °C	100–260 °C
Pyrolytic 		
Automatic programmes 		
Further 		
Eco Fan heat	190 °C	100–250 °C
Defrost	25 °C	25–50 °C
Settings 		

# Energy saving tips

---

## Cooking programmes

- If possible, use the automatic programmes for cooking food.
- Remove all accessories from the oven compartment that are not required for cooking.
- In general, if a range of temperatures is given in a recipe or chart, it is best to select the lower temperature and to check the food after the shortest duration.
- Preheat the oven compartment only if instructed to do so in the recipe or the cooking chart.
- If possible, do not open the door during a programme.
- Use dark, matt bakeware and cooking containers made of non-reflective materials (enamelled steel, heat-resistant glass, coated aluminium). Shiny materials such as stainless steel or aluminium reflect the heat and therefore can give a more uneven food heating result. Do not cover the oven floor or the rack with heat-reflecting aluminium foil.
- Monitor cooking durations to avoid wasting energy when cooking. Set the cooking duration, or use a food probe if you have one.
- The Fan plus  function can be used for cooking many types of food. Because the fan distributes the heat in the oven compartment straight away, it allows you to use a lower temperature than you would with Conventional heat . It also enables you to cook on multiple shelf levels at the same time.
- Eco Fan heat  is an innovative function which is suitable for smaller foodstuffs, e.g. frozen pizzas, part-baked rolls, biscuits and for meat dishes and roasts. Energy-efficient cooking thanks to optimal utilisation of heat. When cooking on a single shelf, up to 30 % less energy is used with comparatively good cooking results. Do not open the door during the cooking programme.
- Fan grill  is the best function for grilled dishes. With this function you can use lower temperatures than in other grill functions which use the maximum temperature setting.
- Whenever possible you should cook multiple foods at the same time. Place them next to each other in the oven or on different shelf levels.
- Foods which you are unable to cook at the same time should, if possible, be cooked one after the other in order to make use of existing heat in the oven.

## Residual heat utilisation

- In cooking programmes using temperatures greater than 140 °C and with cooking durations longer than 30 minutes, the temperature can be turned down to the lowest possible level about 5 minutes before the end of the cooking programme. The residual heat in the oven is sufficient for cooking the food until it is done. However, never switch the oven off (see “Warning and safety instructions”).
- If you have set a cooking duration for a cooking programme, the oven heating elements will switch off automatically shortly before the end of cooking. The residual heat in the oven is sufficient to complete the cooking process.
- It is best to start the pyrolytic cleaning programme immediately after a cooking programme. The residual heat in the oven will help reduce the amount of energy required.

## Customising settings

- Select Display | QuickTouch | Off for the control elements to reduce energy consumption.
- For the oven interior lighting, select Lighting | Off or “On” for 15 seconds. The oven interior lighting can be switched on again at any time by touching the  sensor control.

## Energy-saving mode

The oven will switch itself off automatically to save energy if a programme is not being run and controls have not been operated. The time of day will appear in the display or the display will remain dark (see “Settings”).

# Operation

- Switch the oven on.

The main menu will appear.

- Place the food in the oven compartment.
- Select the operating mode you want to use.

The operating mode will appear first, followed by the recommended temperature.

- Change the recommended temperature if necessary.

The recommended temperature will be accepted within a few seconds. You can change the temperature subsequently via the arrow buttons.

- Confirm with *OK*.

The actual temperature will appear and the heating-up phase will commence.

You will see the temperature increasing. A buzzer will sound when the set temperature is reached for the first time.

- After cooking, select the sensor control for the selected operating mode to end the cooking process.
- Take the food out of the oven compartment.
- Switch the oven off.



## Changing values and settings for a cooking programme

Depending on the function, as soon as a cooking programme is in progress, you can change the values or settings for this programme.

Depending on the function, you can change the following settings:

- Temperature
- Duration
- Finish at
- Start at

## Changing the temperature

Select Further  | Settings  | Recommended temps., to permanently reset the recommended temperatures to suit your cooking preferences.

- Select the  $\wedge$  or  $\vee$  arrow buttons or swipe to the right or left in the  area.

The desired temperature appears in the display.

- Change the desired temperature via the navigation area.

The temperature changes in 5 °C steps.

- Confirm with *OK*.

The cooking programme will restart with the new desired temperature.

## Setting cooking durations

Cooking results can be impaired if there is a long delay between the food being placed in the oven and the start of cooking. Fresh food can change colour and even deteriorate. When baking, the cake mixture or dough can dry out, and the raising agents can lose their effectiveness. Select as short as possible a time until the cooking programme starts.

You have placed the food in the oven compartment, selected an operating mode and the required settings such as the temperature.

By entering Duration, Finish at or Start at via the ⌚ sensor control, you can automatically switch the cooking process off or on and off.

- Duration  
Enter the required cooking duration for the food. The heating will switch off automatically once this duration has elapsed. The maximum cooking duration that can be set depends on the operating mode that you have selected.
- Finish at  
Specify when you want the cooking process to end. The oven heating will switch off automatically at the time you have set.
- Start at  
This function will only appear in the menu if you have set a Duration or Finish at time. With Start at, you have to specify when you want the cooking process to start. The oven heating will switch on automatically at the time you have set.

- Select the ⌚ sensor control.
- Set the desired times.
- Confirm with OK.
- Touch the ⏪ sensor control to return to the menu for the selected operating mode.

## Changing the set cooking durations

- Select the ⌚ sensor control.
- Select the desired time.
- Confirm with OK.
- Select Change.
- Change the set time.
- Confirm with OK.
- Touch the ⏪ sensor control to return to the menu of the selected function.

These settings will be deleted in the event of a power failure.

## Deleting the set cooking durations

- Select the ⌚ sensor control.
- Select the desired time.
- Confirm with OK.
- Select Delete.
- Confirm with OK.
- Touch the ⏪ sensor control to return to the menu of the selected function.

If you delete Duration, the set times for Finish at and Start at are also deleted.

If you delete Finish at or Start at, the cooking programme will start using the cooking duration set.

# Operation

## Cancelling a cooking programme

- Touch the sensor control for the selected function or the ↩ sensor control.
- When **Cancel process** appears in the display, confirm with **OK**.



The oven compartment heating and lighting will then switch off. Any cooking durations set will be deleted.

The main menu will appear.

## Pre-heating the oven



The **Booster** is used in conjunction with certain functions to quickly pre-heat the oven.



It is only necessary to pre-heat the oven in a few instances.

- Most dishes can be placed in the cold oven to make use of the heat produced during the heating-up phase.
- Pre-heat the oven when cooking the following food with the following functions:
  - Dark bread dough as well as beef sirloin joints and fillet with the **Fan plus**  and **Conventional heat**  functions
  - Cakes and pastries with a short cooking duration (approx. 30 minutes or less) as well as delicate items (e.g. sponge) with the **Conventional heat**  function (without the **Booster** function)

## Booster

The **Booster** function is used to quickly pre-heat the oven compartment.

This function is switched on as the factory default setting for the following functions (Further  | Settings  | **Booster** | On):

- Fan plus 
- Conventional heat 
- Auto roast 

If you set a temperature above 100 °C and the **Booster** function is switched on, a rapid heating-up phase heats the oven to the set temperature. The top heat/grill element and the ring heater element come on together with the fan.

Delicate items (e.g. sponge or biscuits) will brown too quickly on the top if the **Booster** function is used.

Switch off the **Booster** function for these items.

## Switching off **Booster** for a cooking process

- Select the **Booster** | Off setting before selecting the desired operating mode.

The **Booster** function is switched off during the heating-up phase. Only the heater elements for the selected operating mode are used to pre-heat the oven compartment.

If you then want to restart a cooking process with the **Booster** function, select the **Booster** | On setting to switch the function on again.

The wide range of automatic programmes enables you to achieve excellent results with ease.

## Categories

The  automatic programmes are sorted into categories to provide a better overview. Simply select the appropriate programme for the type of food you are cooking and follow the instructions in the display.

## Using automatic programmes

- Select Automatic programmes .

A list will appear in the display.

- Select the desired food category.

The automatic programmes available for the food category selected will then appear.

- Select the desired automatic programme.
- Follow the instructions in the display.

## Handy hints

- When using automatic programmes, the recipes provided are designed as a guide only. Other similar recipes, including those using different quantities, can be used for the automatic programme in question.
- After cooking, allow the oven compartment to cool down to room temperature again before starting an automatic programme.
- Some automatic programmes require a pre-heating phase before food is placed in the oven compartment. A prompt will appear in the display indicating when this needs to be done.
- Some automatic programmes require the addition of liquid after a certain cooking duration. You will be prompted by a message in the display when this needs to be done (e.g for adding liquid).
- The duration quoted for automatic programmes is an estimate. It may increase or decrease depending on the programme. The duration, in particular with meat, will vary depending on the initial temperature of the food.

## Further applications

---

This section provides information on the following applications:

- Defrost
- Drying
- Low temperature cooking
- Frozen food/ready meals
- Heating crockery

### Defrost

Gentle defrosting of frozen goods means that the vitamins and minerals are generally retained.

- Select Further .
- Select Defrost.
- Alter the recommended temperature if necessary.

Air is circulated throughout the oven compartment to gently defrost the frozen goods.

 Risk of infection from bacteria. Bacteria such as salmonella can cause life-threatening food poisoning.

It is particularly important to observe food hygiene rules when defrosting fish and meat, and in particular when defrosting poultry.

Do not use the liquid produced during defrosting.

Process the food as required as soon as it has been defrosted.

### Tips

- Remove the packaging and place the frozen goods on the universal tray or in a suitable bowl or dish.
- Use the universal tray with the rack placed on top of it for defrosting poultry. This way the frozen goods will not be lying in the defrosted liquid.
- Meat, poultry or fish does not need to be fully defrosted before cooking. Defrost until the food has started to thaw. The surface will then be sufficiently thawed to take herbs and seasoning.

### Drying

Dehydrating or drying is a traditional method of preserving fruit, certain vegetables and herbs.





It is important that fruit and vegetables are ripe and not bruised before they are dried.





- Peel and core the food for drying, if necessary, and cut it up.
- Distribute the food for drying evenly in a single layer according to size over the wire rack or the universal tray.

**Tip:** You can also use the gourmet perforated baking tray, if you have one.

- Dry on a maximum of 2 levels at the same time.  
Place the food for drying on shelf levels 1+3.  
If using the wire rack and universal tray, place the universal tray below the wire rack.
- Select Fan plus .
- Alter the recommended temperature and then set the drying time.
- Turn the food for drying on the universal tray at regular intervals.

The drying times are longer for whole or halved dried food.

Food for drying		🌡️ [°C]	🕒 [h]
Fruit		60–70	2–8
Vegetables		55–65	4–12
Mushrooms		45–50	5–10
Herbs*		30–35	4–8

 Operating mode, 🌡️ Temperature,  Drying time,  Fan plus,  Conventional heat

\* Dry herbs only on the universal tray on shelf level 2 and use the Conventional heat  operating mode, as the fan is switched on in the Fan plus operating mode.

- Reduce the temperature if condensation begins to form in the oven compartment.

### Removing the dried food

 Risk of injury caused by hot surfaces.

The oven gets hot during operation. You could burn yourself on the heating elements, oven compartment or accessories.

Use oven gloves when removing dried food from the oven.

- Allow the dried fruit or vegetables to cool down after drying.

Dried fruit needs to be completely dry, but also soft and elastic. Juice should not escape when cut.

- Store dried food in sealed glass jars or tins.

## Further applications

### Low temperature cooking

Low temperature cooking is ideal for cooking delicate cuts of beef, pork, veal or lamb when a tender result is desired.

First sear the meat all over at a high temperature on the hob in order to seal it.

Then place the meat in the pre-heated oven compartment where the low temperature and long cooking duration will cook it to perfection and ensure it is very tender.

The meat will relax. The juices inside will start to circulate evenly throughout the meat to reach the outer layers. This gives very tender and succulent results.

- Only use lean meat which has been correctly hung and trimmed. Bones must be removed before cooking.
- For searing, use a suitable cooking oil or fat that can withstand high temperatures (e.g. clarified butter, vegetable oil).
- Do not cover meat during the cooking process.

The cooking duration takes approx. 2–4 hours depending on the weight and size of the meat and how well you want it cooked.

- As soon as the cooking process is done, you can carve the meat straight from the oven. It does not need to rest.
- The meat can be left in the oven compartment to keep warm until you serve it. This will not affect results in any way.

- Serve on pre-heated plates with very hot sauce or gravy to prevent it cooling down too quickly. The meat is at the ideal temperature for eating straight away.

### Using Conventional heat

Take a look at the information in the cooking charts at the end of this booklet.

Use the universal tray with the rack placed on top of it.

- Place the rack together with the universal tray on shelf level 2.
- Select the Conventional heat  function and a temperature of 120 °C.
- Pre-heat the oven together with the universal tray and rack for approx. 15 minutes.
- Whilst the oven compartment is pre-heating, sear the meat thoroughly on all sides on the hob.

 Danger of burning due to hot surfaces.

The oven gets hot during operation. You could burn yourself on the heating elements, oven compartment or accessories.

Use oven gloves when placing food in the oven or removing it and when working in the hot oven compartment.

- Place the seared meat on the rack.
- Reduce the temperature to 100 °C (see “Cooking charts”).
- Continue cooking until the end of the cooking duration.

### Frozen food/Ready meals

#### Tips for cakes, pizza and baguettes

- Bake cakes, pizza and baguettes on baking paper on the rack.  
Do not use the baking tray or the universal tray for frozen foods with a large surface area. The tray could become warped and difficult, or even impossible, to remove from the oven compartment when hot. Additional use will make the warping worse.
- Use the lowest temperature recommended on the packaging.

#### Tips for French fries, croquettes and similar items

- These frozen items can be cooked on the baking tray or universal tray.  
Place baking parchment on the tray so that they cook gently.
- Use the lowest temperature recommended on the packaging.
- Turn food several times during cooking.

#### Preparing frozen food/ready meals

Handling food carefully will help protect your health.

Cakes, pizzas and french fries should be cooked until golden, not dark brown.

- Select the function and temperature recommended on the packaging.
- Pre-heat the oven compartment.
- Place the food in the pre-heated oven compartment on the shelf level recommended on the packaging.

- Check the food at the end of the shortest cooking duration recommended on the packaging.

### Heat crockery

Use the Fan plus  operating mode for pre-heating crockery.

Only pre-heat heat-resistant crockery.

- Place the wire rack on shelf level 1 and place the crockery to be pre-heated on it. Depending on the size of the crockery, you can also place the rack on the oven floor and take the side runners out to make more room.
- Select Fan plus .
- Set the temperature to 50–80 °C.

 Risk of burns!

Use oven gloves when removing the crockery from the oven. Droplets of water may have accumulated underneath the crockery.

- Remove the heated crockery from the oven.

# Baking

Handling food carefully will help protect your health.

Cakes, pizzas and french fries should be cooked until golden, not dark brown.

## Tips on baking

- Set a cooking duration. If used for baking, do not delay the start for too long. Cake mixture or dough will dry out, and the raising agents will lose their effectiveness.
- Generally speaking, you can use racks, baking trays, universal trays and any type of baking tray made of heat-resistant material.
- Avoid using bright, thin-walled tins as they give an uneven or poor browning result. Under adverse circumstances, the food will not cook properly.
- Position rectangular tins with the longer side across the width of the oven compartment for optimum heat distribution and even baking results.
- Always place bakeware on the rack.
- Bake cakes with fruit toppings or deep cakes on the universal tray.

## Using baking parchment

Miele accessories, e.g. the universal tray, are treated with PerfectClean enamel (see “Features”). Surfaces treated with PerfectClean enamel generally do not need to be greased or covered with baking parchment.

- Use baking parchment when baking lye mixtures because the sodium hydroxide used can damage the surface treated with PerfectClean.
- Use baking parchment when baking sponge, meringue, macaroons or similar items. Due to their high egg white content, these are more likely to stick.
- Use baking paper when cooking frozen food on the rack.

## Notes on the cooking charts

You can find the cooking charts at the end of this book.

### Selecting the temperature

- As a general rule, select the lower temperature given in the chart. Baking at temperatures higher than those recommended may reduce the cooking duration, but will lead to uneven browning of the food, and unsatisfactory cooking results.

### Selecting the cooking duration

Unless otherwise stated, the cooking durations given in the cooking charts are for an oven compartment which has not been pre-heated. With a pre-heated oven compartment, shorten times by around 10 minutes.

- As a general rule, check the food after the shortest duration. Stick a wooden skewer into the food.

If it comes out clean without any batter/dough on it, the food is done.

## Notes on the functions

You can find an overview of all the functions with their recommended values in “Main and sub-menus”.

### Using Automatic programmes

- Follow the instructions in the display.

### Using Fan plus

Because the fan distributes the heat around the oven compartment straight away, it allows you to use a lower temperature than you would with the Conventional heat  function.

Use this function if you are baking on multiple shelves at the same time.

- 1 shelf: place the food in shelf level 2.
- 2 shelves: place the food on shelf levels 1+3 or 2+4.
- 3 shelves: place the food on shelf levels 1+3+5.

### Tips

- If you are cooking on multiple shelves at the same time, slide the universal tray in on the lowest level.
- For moist biscuits and cakes, bake on a maximum of 2 shelf levels at once.

### Using Intensive bake

Use this function for baking cakes with moist toppings.

Do **not** use this function for baking thin biscuits.

- Place cakes on shelf level 1 or 2.

### Using Conventional heat

Dark metal, enamel, or aluminium bakeware with a matt finish, as well as heat-resistant glass, ceramic, and coated bakeware can be used.

Use this function for baking traditional recipes. If using an older recipe or cookbook, set the oven temperature 10 °C lower than the recommended one. This will not change the cooking duration.

- Place the food in shelf level 1 or 2.

### Using Eco Fan heat

Use this function for cooking small amounts of food, e.g. frozen pizzas, part-baked rolls or biscuits, while saving energy.

- Place the food in shelf level 2.

# Roasting

---

## Tips for roasting

- You can use all crockery made from temperature-resistant materials, e.g. roasting dishes, roasting pans with lid, ovenproof glass dishes, roasting bags, dishes made from earthenware or cast iron, the universal tray, rack and/or anti-splash insert (if available) on top of the universal tray.
- **Pre-heating** the oven compartment is only required when roasting beef sirloin joints and fillet. Pre-heating is generally not necessary.
- Use a **closed roasting dish** for roasting meat, such as an oven dish. The meat stays succulent. The oven compartment will also stay cleaner than when roasting on the rack. This ensures that sufficient stock remains for making gravy.
- If you are using a **roasting bag**, follow the instructions on the packaging.
- If you are using the **rack** or an **open roasting dish** for roasting, you can add a little fat or oil to very lean meat or place a few strips of streaky bacon on the top.
- **Season** the meat and place in the roasting dish. Dot with butter or margarine or brush with oil or cooking fat if necessary. For large lean cuts of meat (2–3 kg) and fatty poultry add about 1/8 litre of water to the dish.
- Do not add too much liquid during cooking as this will hinder the **browning** process. Browning only occurs towards the end of the cooking duration. Remove the lid about halfway through the cooking duration if a more intensive browning result is desired.



- At the end of the programme, take the food out of the oven compartment, cover it and leave to **stand** for about 10 minutes. This helps retain juices when the meat is carved.
- For a crisp finish, baste **poultry** 10 minutes before the end of the cooking duration with slightly salted water.

## Notes on the cooking charts

You can find the cooking charts at the end of this book.

- Take note of the temperature range, the shelf levels and the timings. These also take the type of cooking container, the size of the meat and cooking practices into account.

## Selecting the temperature

- As a general rule, select the lower temperature given in the chart. If higher temperatures are used, the meat will brown on the outside, but will not be properly cooked through.
- When cooking with Fan plus  and Auto roast , select a temperature 20 °C lower than when using Conventional heat .
- For cuts which weigh more than 3 kg, select a temperature approx. 10 °C lower than that given in the roasting chart. The roasting process will take longer, but the meat will cook evenly through and the skin or crackling will not be too thick.
- When roasting on the rack, set a temperature approx. 10 °C lower than for roasting in a covered oven dish.

## Selecting the cooking duration

Unless otherwise stated, the durations given in the cooking chart are for an oven compartment which has not been pre-heated.

- The traditional British method for calculating the roasting time is to allow 15 to 20 minutes per lb/450 grammes, according to type of meat, plus approx. 20 minutes, adjusting the length of time as roasting proceeds to obtain the required result. The roasting time can also be determined by multiplying the thickness of the roast [cm] with the time per cm [min/cm] stated below, depending on the type of meat:
  - Beef/venison: 15–18 min/cm
  - Pork/veal/lamb: 12–15 min/cm
  - Sirloin/fillet: 8–10 min/cm
- As a general rule, check the food after the shortest duration.

## Tips

- For frozen meat, increase the cooking duration by approx. 20 minutes per kg.
- Frozen meat weighing less than approx. 1.5 kg does not need to be defrosted before roasting.

## Notes on the functions

You can find an overview of all the functions with their recommended values in “Main and sub-menus”.

Use the Bottom heat  function towards the end of the cooking duration to brown the base of the food.



Do not use the Intensive bake  function for roasting as the juices will become too dark.

## Using Automatic programmes

- Follow the instructions in the display.

## Using Fan plus or Auto roast

These functions are suitable for roasting meat, fish and poultry that needs to be well browned as well as sirloin joints and fillet.

The Fan plus  function allows you to use a lower temperature than you would with the Conventional heat  function, because the heat is immediately distributed around the oven compartment.

In the Auto roast  function, the oven compartment heats initially to a high searing temperature (approx. 230 °C). As soon as this temperature has been reached, the oven automatically drops the temperature back down to the pre-selected roasting temperature (continued roasting).

- Place the food in shelf level 2.

## Using Conventional heat

Use this function for baking traditional recipes. If using an older recipe or cookbook, set the oven temperature 10 °C lower than the recommended one. This will not change the cooking duration.

- Place the food in shelf level 2.

## Using Eco Fan heat

Use this function for cooking smaller roasts or meat dishes while saving energy.

- Place the food in shelf level 2.

# Grilling

 Risk of injury caused by hot surfaces.

If you grill with the door open, hot air will escape from the oven instead of being cooled by the cooling fan. The control elements will get hot.

Grill with the oven door closed.

## Tips for grilling

- Pre-heating is necessary when grilling. Pre-heat the top heat/grill element for approx. 5 minutes with the door closed.
- Trim the meat if necessary. Do not season the meat with salt before grilling as this draws the juices out.
- Add a little oil to lean meat if necessary. Do not use other types of fat as they can easily burn and cause smoke.
- Clean fish in the normal way. To enhance the flavour, season with a little salt. Fish can also be drizzled with lemon juice.
- Use the universal tray with the wire rack or the grilling and roasting insert (if present) in place. The juices collect under the insert. This prevents them from spitting and making the oven dirty and they can then be used for making gravy and sauces. Brush the wire rack or the grilling and roasting insert with oil and then place the food on top.

Do not use the baking tray.

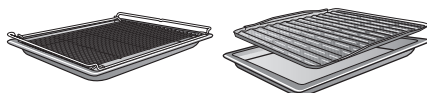

## Notes on the cooking charts

You can find the cooking charts at the end of this book.

- Take note of the temperature range, the shelf levels and the durations. These take the size of the meat and cooking practices into account.
- Check the food after the shortest duration quoted.

## Selecting the temperature

- As a general rule, select the lower temperature given in the chart. If higher temperatures are used than those specified, the meat will brown on the outside, but will not be properly cooked through.

## Choosing a shelf level

- Select the shelf level depending on the thickness of the food to be cooked.
- Place flat food in shelf level 3 or 4.
- Place thicker food in shelf level 1 or 2.

## Selecting the cooking duration

- Grill thinner cuts of meat/slices of fish for approx. 6–8 minutes per side. It is best to grill food of a similar thickness at the same time so that the cooking durations do not vary too much.
- As a general rule, check whether the food is cooked after the shortest duration.
- To **test the food**, press down on the meat with a spoon. This lets you determine how well the meat has been cooked.
  - **Rare/pink**  
If the meat gives easily to the pressure of the spoon, it will still be red on the inside.
  - **Medium**  
If there is some resistance, the inside will be pink.
  - **Well done**  
If there is very little resistance, it is cooked through.

**Tip:** If the surface of a thicker cut of meat is browned but the centre is still raw, move the food to a lower level or reduce the temperature and continue grilling. This will stop the surface from becoming excessively charred.

## Notes on the functions

You can find an overview of all the functions with their recommended values in “Main and sub-menus”.

### Using Full grill

Use this function to grill flat thin cuts in large quantities and for browning large baked dishes.

The whole of the top heating/grill element glows red to provide the required heat.

### Using Fan grill

This function is suitable for grilling thicker food, such as chicken.

A temperature setting of 220 °C is generally recommended for thinner types of food, while 180–200 °C is recommended for thicker cuts.

# Cleaning and care

 Danger of injury caused by hot surfaces.

The oven gets hot during operation. You could burn yourself on the heating elements, oven compartment or accessories.

Allow the heating elements, oven compartment and the accessories to cool before manual cleaning.

 Risk of injury due to electric shock.

The steam from a steam cleaning appliance could reach live electrical components and cause a short circuit. Never use a steam cleaner for cleaning.

Surfaces can discolour or alter if unsuitable cleaning agents are used. The oven front is particularly susceptible to damage from oven cleaners or descaling agents. All surfaces are susceptible to scratching. Scratches on glass can in some circumstances lead to breakage. Remove all cleaning agent residues immediately.

## Unsuitable cleaning agents

To avoid damaging the surfaces, do not use:

- cleaning agents containing soda, ammonia, acids or chlorides
- cleaning agents containing descaling agents on the front
- abrasive cleaning agents (e.g. powder cleaners, scouring milk, scouring pads)
- solvent-based cleaning agents
- stainless-steel cleaning agents

- dishwasher cleaner
- glass cleaning agents
- cleaning agents for ceramic glass hobs
- hard, abrasive brushes or sponges (e.g. pot scourers, brushes or sponges which have been previously used with abrasive cleaning agents)
- melamine eraser blocks
- sharp metal scrapers
- wire wool
- spot cleaning with mechanical cleaning agents
- oven cleaners
- stainless-steel spiral pads

If soiling is left on for any length of time, it may become impossible to remove. If items are used frequently without being cleaned, it may become very difficult to clean them. It is therefore best to remove any soiling immediately.

The accessories are not dishwasher-safe.

**Tip:** Soiling caused by spilt fruit juices and cake mixtures is best removed while the oven compartment is still warm.

To make it easier to clean the oven:

- Remove the door.
- Take out the side runners with FlexiClip runners (if fitted).
- Lower the top heat/grill element.

## Removing normal soiling

There is a delicate fibreglass seal around the oven compartment to seal the glass in the oven door. This can be damaged by rubbing or scouring.

Avoid cleaning the fibreglass seal.

## Removing normal soiling

- Remove normal soiling immediately with warm water, washing-up liquid and a clean sponge or a clean, damp microfibre cloth.
- Remove all cleaning agent residues thoroughly with clean water. This is particularly important for any parts with a PerfectClean finish, as cleaning agent residues will impair the non-stick function.
- After cleaning, wipe the surfaces dry using a soft cloth.

## Removing stubborn soiling (excluding the FlexiClip runners)

Spilt fruit and roasting juices may cause lasting discolouration or matt patches on surfaces. This discolouration will not affect the properties of the surface finish. Do not attempt to remove these stains. Only use the equipment specified.

- Baked-on deposits can be removed with a glass scraper or with a stainless-steel spiral pad (e.g. Spontex Spirinett), hot water and washing-up liquid.

## Using oven cleaners

- Very stubborn soiling on PerfectClean surfaces can be cleaned using the Miele oven cleaner, which must only be applied to cold surfaces.

If the oven spray gets into gaps and openings, a strong odour is generated during subsequent cooking programmes.

Do not spray the oven cleaner onto the roof of the oven compartment.

Do not spray the oven cleaner into the gaps and openings of the oven compartment walls and rear wall.

- Follow the instructions on the packaging.

Oven cleaners from other manufacturers must only be used in a cold oven and for no longer than a maximum of 10 minutes.

- You can then also use the scouring pad on the back of a washing-up sponge to remove the soiling.
- Remove all cleaning agent residues thoroughly with clean water.
- Dry all surfaces with a soft cloth.

# Cleaning and care

---

## Stubborn soiling on the FlexiClip runners

Cleaning FlexiClip telescopic runners in a dishwasher would remove the special grease which is essential for their smooth functioning. Never attempt to clean FlexiClip telescopic runners in a dishwasher.

For stubborn surface soiling or if the bearings become sticky with spilled fruit juices proceed as follows:

- Soak the FlexiClip runners for approx. 10 minutes in a solution of hot water and washing-up liquid. If necessary use the back of a washing-up sponge to remove the soiling. The bearings can be carefully cleaned with a soft brush.

Cleaning may cause some discolouration or fading in places, however this will not affect the functioning of the runners in any way.

## Pyrolytic cleaning of the oven compartment

Instead of cleaning the oven compartment manually you can run the Pyrolytic  function.

During pyrolytic cleaning the oven compartment reaches temperatures in excess of 400 °C. Any residual soiling is burnt off and turned to ash by the high temperatures.

There are 3 pyrolytic settings available, each with a different duration:

- Level 1 for light soiling
- Level 2 for heavier soiling
- Level 3 for very heavy soiling

The oven door is automatically locked when the pyrolytic cleaning process is started. It cannot be opened until after the programme has finished.

The timer can be used to delay the start time of the pyrolytic cleaning programme, for instance to make use of cheaper electricity tariffs.

At the end of the pyrolytic cleaning programme any residues such as ash from the pyrolytic process, which may be formed depending on the oven compartment's degree of soiling, can be easily wiped away.

## Preparing for pyrolytic cleaning

Accessories will be damaged by the high temperatures in pyrolytic cleaning.

Remove all accessories from the oven before starting the pyrolytic cleaning programme. This also applies to the side runners and any optional accessories.

Coarse soiling in the oven can cause thick smoke to develop.

Burnt-on residues can cause lasting discolouration or dull spots on enamelled surfaces.

Before starting the pyrolytic cleaning programme, remove coarse soiling from the oven and scrape any burnt-on residues off enamelled surfaces with a glass scraper.

- Remove any accessories from the oven compartment, including the side runners.

## Starting pyrolytic cleaning

 Risk of injury caused by hot surfaces.

The oven gets much hotter during pyrolytic cleaning than during normal use.

Do not let children touch the oven during pyrolytic cleaning.

- Select Pyrolytic .
- Select the level required according to the amount of soiling.
- Confirm with *OK*.

Follow the instructions in the display.

- Confirm with *OK*.

You can start the pyrolytic cleaning programme straight away or delay the start time.

## Starting pyrolytic cleaning straight away



- To start the pyrolytic cleaning programme straight away, select *Start now*.
- Confirm with *OK*.

The pyrolytic cleaning programme will start.

The door will lock automatically. The oven heating and the cooling fan will then switch on automatically.

The oven interior lighting will not come on during the pyrolytic cleaning programme.

The time remaining for the pyrolytic cleaning programme will start counting down in the display. You cannot alter the duration.

You can use the minute minder at the same time as running the cleaning programme. At the end of the minute minder time the buzzer will sound,  will start flashing and the time can be viewed counting up in the display. To switch of the visual and acoustic signals, touch the  sensor control.

## Starting pyrolytic cleaning at a later time

- To start the pyrolytic cleaning programme later, select *Start at*.
- Confirm with *OK*.
- Set the time when you want the pyrolytic cleaning programme to start.

## Cleaning and care

- Confirm with OK.

The door will lock automatically. Start at and the start time set will appear in the display.

The  sensor control lights up orange.

You can reset the start time via the  sensor control at any point up to the starting time.

As soon as the start time has been reached, the oven heating and cooling fan will switch on automatically and the time remaining will appear in the display.

### Finishing off the pyrolytic cleaning process

When the time remaining has counted down to 0:00 h, a message will appear in the display to tell you that the door is unlocking.

Process finished will appear in the display and a buzzer will sound as soon as the door has been unlocked.

- Switch the oven off.

The visual and acoustic signals will switch off.

 Risk of injury caused by hot surfaces.

At the end of the pyrolytic cleaning function, the oven will still be very hot. You could burn yourself on the heater elements and oven compartment.

Allow the heater elements and the oven compartment temperature to drop to a safe level before removing any residues.

- Clean the oven compartment to remove any pyrolytic residues (e.g. ash) that may have built up depending on the degree of soiling in the oven.

Most residues can be removed with hot water, a little washing-up liquid and a clean sponge or a clean, damp microfibre cloth.

Depending on the degree of soiling, a visible deposit could build up on the glass on the inside of the oven door. This can be removed with a dishwashing sponge, a glass scraper or a stainless steel spiral pad (e.g. Spontex Spirinett) and a little washing-up liquid.

There is a delicate fibreglass seal around the oven compartment to seal the glass in the oven door. This can be damaged by rubbing or scouring.

Avoid cleaning the fibreglass seal.

Enamelled surfaces can be permanently discoloured by spilt fruit juices. Such discolouration does not affect the properties of the enamel. Do not attempt to remove these stains.

## Door removal

The door weighs approx. 10 kg.

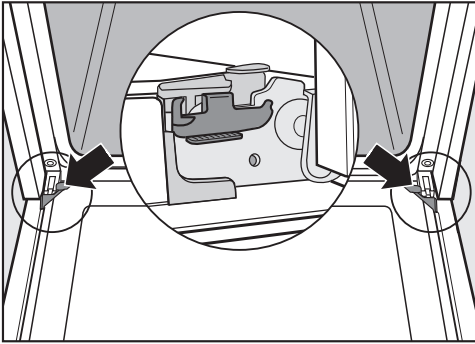

The oven door is connected to the door hinges by retainers.

Before removing the door from the retainers, the locking clamps on both door hinges have to be released.

- Open the door fully.

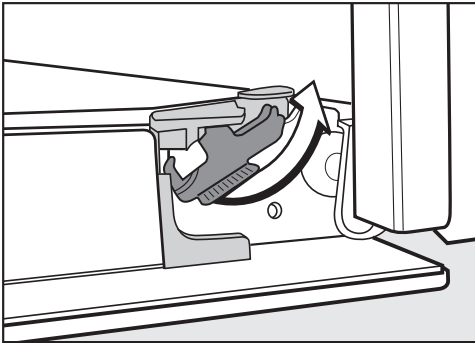

- Release the locking clamps by turning them as far as they will go.

The oven could become damaged if you incorrectly remove the door. Never pull the door horizontally off its retainers, as they will spring back against the oven. Never pull the door off the retainers by the handle, as the handle could break off.

- Raise the door up till it rests partially open.



- Hold the door on either side and pull it diagonally upwards off the retainers. Make sure that the door goes back on straight.

# Cleaning and care

## Dismantling the door

The oven door is an open system with 4 glass panes which have a heat-reflective coating on some of their surfaces. When the oven is operating, air is directed through the door to keep the outer pane cool.

If soiling has worked its way in between the glass panes, the door can be dismantled in order to clean in between the panes.

Scratches on the door glass can cause the glass to break.

Do not use abrasive cleaners, hard sponges, brushes or sharp metal tools to clean the door glass.

When cleaning the door glass, you must also follow the instructions that apply to the oven front.

The different sides of the door glass have different coatings. The sides facing the oven compartment have heat-reflecting properties.

The oven could become damaged if you fit the door glass the wrong way round.

Make sure that you place the door glass back in the right position after cleaning.

Oven cleaners will damage the surface of the aluminium profiles.

Only clean these parts with warm water and washing-up liquid, applied with a clean sponge cloth or a clean, damp microfibre cloth.

The door glass could break if dropped. Keep the disassembled door glass in a safe place.

 Risk of injury caused by the door slamming shut.

The door may slam shut if you attempt to disassemble it when it is fitted to the oven.

Always remove the door before disassembling it.

- Place the door with the outer glass pane on a soft surface (e.g. a tea towel) to prevent it getting scratched. The door handle should line up with the edge of the table so that the glass lies flat and does not get broken during cleaning.

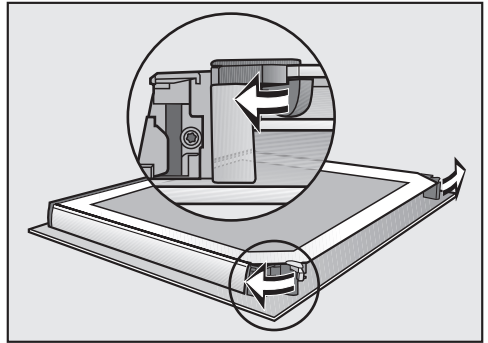

- Flip the two glass pane retainers outwards to open them.

## Cleaning and care

Remove the inner pane and the two middle panes one after the other:

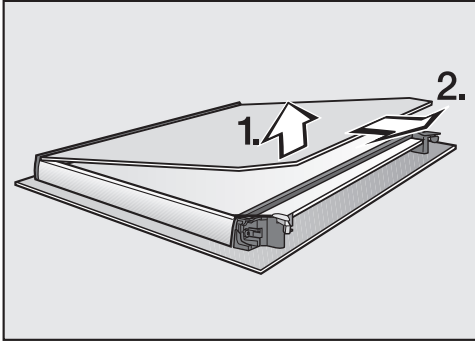

- **Gently** lift the inner pane up and out of the plastic strip.

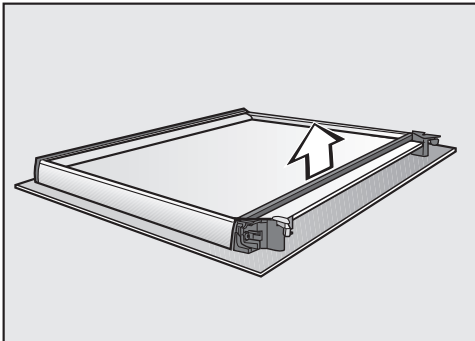

- Remove the seal.

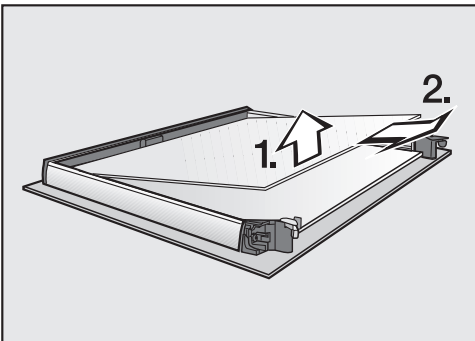

- Carefully lift the upper of the two middle panes up and take it out.

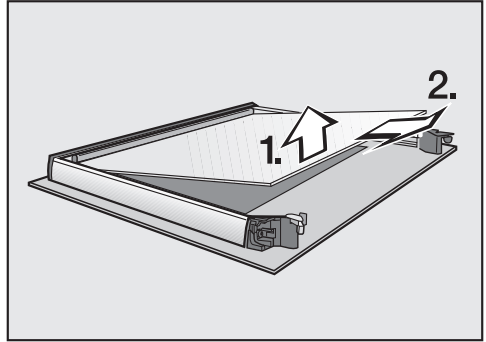

- Then lift the lower of the two middle panes up carefully and take it out.
- Clean the door panes and other parts with a clean sponge and a solution of hot water and washing-up liquid or a clean, damp microfibre cloth.
- Dry all parts with a soft cloth.

## Cleaning and care

Then reassemble the door carefully:

The two middle panes are identical. To help you put them back in correctly, the material number is printed on the panes.

- Refit the lower of the two middle panes in such a way that the material number is legible (i.e. not reversed).

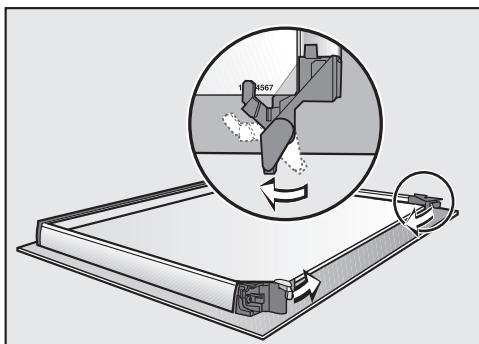

- Flip both the glass pane retainers inwards in such a way that they fit over the lower of the two middle panes.
- Refit the upper of the two middle panes in such a way that the material number is legible (i.e. not reversed). The pane must rest on the retainers.

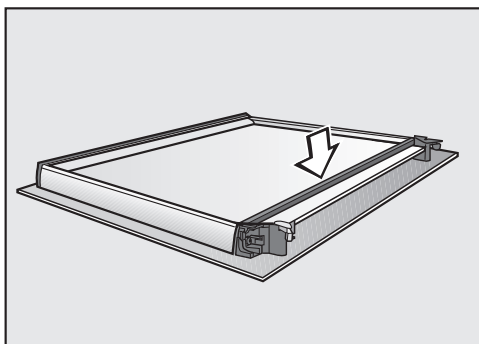

- Refit the seal.

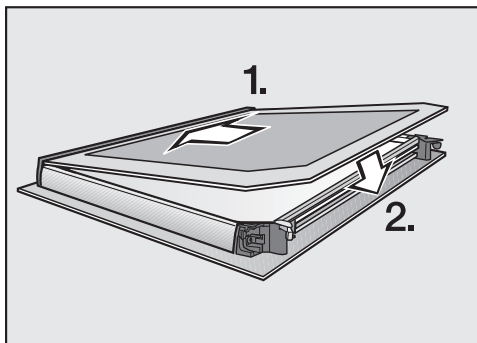

- Push the inner pane with the matt printed side facing downwards into the plastic strip and place it between the retainers.

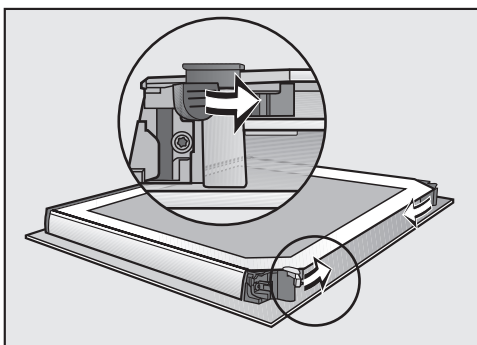

- Flip both the glass pane retainers inwards to close them.

The door is now reassembled.

## Fitting the door

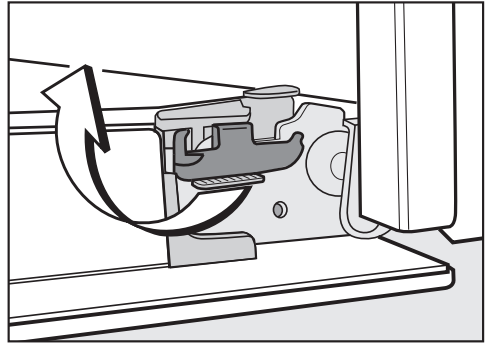
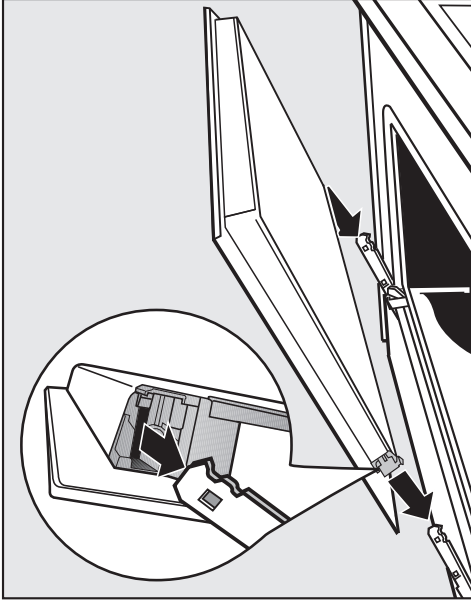

- Hold the door securely on both sides and carefully fit it back into the hinge retainers. Make sure that you fit the door straight.
- Open the door fully.

- To relock the locking clamps, turn them back up to the horizontal position as far as they will go.

If the locking clamps are not locked, the door could become loose, resulting in damage. Always ensure that the locking clamps are locked after refitting the door.

## Cleaning and care

### Removing the side runners with FlexiClip runners

The side runners can be removed together with the FlexiClip runners (if inserted).

If you wish to remove the FlexiClip runners separately beforehand, please follow the instructions in “Features” – “Fitting and removing FlexiClip runners”.

 **Danger of injury caused by hot surfaces.**

The oven gets hot during operation. You could burn yourself on the heating elements, oven compartment or accessories.

Allow the heating elements, oven compartment and accessories to cool before removing the side runners.

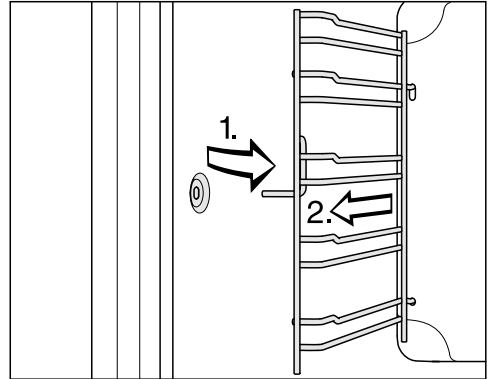

- Pull the side runners out of holder (1.) and remove them (2.).

**Reassemble** by following these instructions in reverse order.

- Insert the components carefully.

## Lowering the top heat/grill element

If the oven compartment roof is badly soiled, the top heat/grill element can be lowered to make cleaning easier. Clean the oven compartment roof regularly with a damp cloth or a dishwashing sponge.

**⚠** Danger of injury caused by hot surfaces.

The oven gets hot during operation. You could burn yourself on the heating elements, oven compartment or accessories.

Allow the heating elements, oven compartment and the accessories to cool before manual cleaning.

The enamel on the oven floor can become damaged by fastening nuts being dropped on it.

Place a cloth or similar item over the oven compartment floor to protect it.

Be careful not to damage the top heat/grill element.

Never use force when lowering the top heat/grill element.

- Carefully lower the top heat/grill element.

You can now access the top of the oven compartment.

- Clean the ceiling of the oven with hot water and washing-up liquid, applied with a clean sponge cloth or a clean, damp microfibre cloth.
- After cleaning, raise the top heat/grill element gently back up again.
- Replace the wing nut and tighten it securely.
- Fit the side runners.

- Remove the side runners.

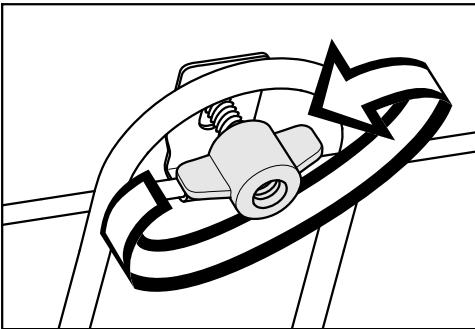



- Unscrew the wing nut.

## Problem solving guide

Many malfunctions and faults that can occur in daily operation can be easily remedied. Time and money will be saved because a service call will not be needed.

The following guide may help you to find the reason for a malfunction or a fault, and to correct it.

Problem	Cause and remedy
<p><b>The display is dark.</b></p>	<p>You have selected the <b>Time   Display   Off</b> setting. When the oven is switched off, the display is dark.</p> <ul style="list-style-type: none"> <li>■ As soon as the oven is switched on, the main menu will appear. If you want the time of day to be displayed constantly, select the <b>Time   Display   On</b> setting.</li> </ul> <hr/> <p>There is no power to the oven.</p> <ul style="list-style-type: none"> <li>■ Check whether the fuse has tripped. Contact a qualified electrician or the Miele Customer Service Department.</li> </ul>
<p><b>The buzzer does not sound.</b></p>	<p>The buzzers are deactivated or set at too low a volume.</p> <ul style="list-style-type: none"> <li>■ Switch on the buzzers or increase the volume with the <b>Volume   Buzzer tones</b> setting.</li> </ul>
<p><b>The oven compartment does not heat up.</b></p>	<p>Demo mode is active. You can select menu options in the display and the sensor controls, but the oven heating does not work.</p> <ul style="list-style-type: none"> <li>■ Deactivate demo mode with the <b>Showroom programme   Demo mode   Off</b> setting.</li> </ul>
<p>Press "OK" for 6 secs <b>appears in the display when the oven is switched on.</b></p>	<p>The  system lock has been activated.</p> <ul style="list-style-type: none"> <li>■ You can deactivate the system lock for a programme by touching the <b>OK</b> sensor control for at least 6 seconds.</li> <li>■ If you want to permanently deactivate the system lock, select the <b>Safety   System lock    Off</b> setting.</li> </ul>



# Problem solving guide

Problem	Cause and remedy
<p><b>The sensor controls do not respond.</b></p>	<p>You have selected the <b>Display   QuickTouch   Off</b> setting. When the oven is switched off, the sensor controls do not respond.</p> <ul style="list-style-type: none"> <li>■ As soon as the oven is switched on, the sensor controls will respond. If you want the sensor controls to respond even when the oven is switched off, select the <b>Display   QuickTouch   On</b> setting.</li> </ul> <p>The oven is not connected to the power supply.</p> <ul style="list-style-type: none"> <li>■ Check that the oven plug is correctly inserted into the socket and switched on.</li> <li>■ Check whether the fuse has tripped. Contact a qualified electrician or the Miele Customer Service Department.</li> </ul> <p>There is a fault with the controls.</p> <ul style="list-style-type: none"> <li>■ Touch and hold the <b>⏻ On/Off</b> sensor control until the display switches off and the oven restarts.</li> </ul>
<p>Power cut <b>appears in the display.</b></p>	<p>There has been a brief power cut. This has caused the current cooking programme to stop.</p> <ul style="list-style-type: none"> <li>■ Switch the oven off and then back on again.</li> <li>■ Restart the cooking programme.</li> </ul>
<p>12:00 <b>appears in the display.</b></p>	<p>The power supply was interrupted for longer than 150 hours.</p> <ul style="list-style-type: none"> <li>■ Reset the time and date.</li> </ul>
<p>Max. op. hours reached <b>appears in the display.</b></p>	<p>The oven has been operating for an unusually long time. This has triggered the safety switch-off function.</p> <ul style="list-style-type: none"> <li>■ Confirm with <b>OK</b>.</li> </ul> <p>The oven is now ready to use.</p>
<p><b>⚠</b> Fault F32 <b>appears in the display.</b></p>	<p>The door lock for pyrolytic cleaning has not locked.</p> <ul style="list-style-type: none"> <li>■ Switch the oven off and then back on again. Start the pyrolytic cleaning programme again.</li> <li>■ If the message appears again, contact the Miele Customer Service Department.</li> </ul>
<p><b>⚠</b> Fault F33 <b>appears in the display.</b></p>	<p>The door lock for pyrolytic cleaning has not opened.</p> <ul style="list-style-type: none"> <li>■ Switch the oven off and then back on again.</li> <li>■ If the door lock still does not deactivate itself, contact the Miele Customer Service Department.</li> </ul>

## Problem solving guide

Problem	Cause and remedy
<b>Fault and a fault code not listed here appears in the display.</b>	<p>A fault has occurred that you cannot resolve.</p> <ul style="list-style-type: none"> <li>■ Call the Miele Customer Service Department.</li> </ul>
<b>A noise can be heard after a cooking programme.</b>	<p>The cooling fan remains switched on after a cooking programme (see “Settings – Cooling fan run-on”).</p>
<b>The oven has switched itself off.</b>	<p>To save power, the oven switches off automatically if a button is not pressed after a certain amount of time or after a cooking programme has ended.</p> <ul style="list-style-type: none"> <li>■ Switch the oven back on.</li> </ul>
<b>Cakes/biscuits are not cooked properly after the duration given in the cooking chart.</b>	<p>A different temperature from the one given in the recipe was used.</p> <ul style="list-style-type: none"> <li>■ Select the temperature required for the recipe.</li> </ul>
	<p>The ingredient quantities are different from those given in the recipe.</p> <ul style="list-style-type: none"> <li>■ Check whether you amended the recipe. The addition of more liquid or more eggs makes a moister mix which requires a longer cooking duration.</li> </ul>
<b>The browning of the baked goods is uneven.</b>	<p>The wrong temperature or shelf level was selected.</p> <ul style="list-style-type: none"> <li>■ There will always be a slight unevenness in browning. If browning is very uneven, check whether the correct temperature and shelf level were selected.</li> </ul>
	<p>The material or colour of the bakeware is not suitable for the oven function selected.</p> <ul style="list-style-type: none"> <li>■ When using the Conventional heat  function, light coloured, shiny tins will not produce as desirable results. Dark, matt tins are best for baking.</li> </ul>
<b>The FlexiClip runners do not push in or pull out smoothly.</b>	<p>The bearings in the FlexiClip runners are not sufficiently lubricated.</p> <ul style="list-style-type: none"> <li>■ Lubricate the bearings with the special Miele lubricant. Only the special Miele lubricant is designed for the high temperatures in the oven compartment. Other lubricants may resinify when heated and will gum up the FlexiClip runners. You can obtain the special Miele lubricant from your Miele dealer or from the Miele Customer Service Department.</li> </ul>

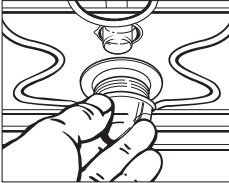
# Problem solving guide

Problem	Cause and remedy
<p><b>There is still soiling in the oven compartment after a pyrolytic cleaning programme.</b></p>	<p>The pyrolytic cleaning programme burns off soiling in the oven and leaves it as ash.</p> <ul style="list-style-type: none"> <li>■ Remove the ash using a damp microfibre cloth or with a clean sponge and a solution of hot water and washing-up liquid.</li> </ul> <p>If there is still coarse soiling left in the oven after the pyrolytic cleaning programme you should start the programme again, selecting a longer duration if necessary.</p>
<p><b>The oven interior lighting switches off after a short time.</b></p>	<p>You have selected the Lighting   "On" for 15 seconds setting.</p> <ul style="list-style-type: none"> <li>■ If you want the oven interior lighting to be switched on during the entire cooking programme, select the Lighting   On setting.</li> </ul>
<p><b>The oven interior lighting is off.</b></p>	<p>You have selected the Lighting   Off setting.</p> <ul style="list-style-type: none"> <li>■ Press the  sensor control to switch on the oven interior lighting for 15 seconds.</li> <li>■ If required, select the Lighting   On or "On" for 15 seconds setting.</li> </ul>
<p><b>The oven interior lighting does not switch on.</b></p> 	<p>The halogen lamp is faulty.</p> <div style="border: 1px solid gray; padding: 10px; margin: 10px 0;"> <p> Risk of injury caused by hot surfaces. The oven gets hot during operation. You could burn yourself on the heating elements, oven compartment or accessories. Allow the heating elements, oven compartment and the accessories to cool before manual cleaning.</p> </div> <ul style="list-style-type: none"> <li>■ Disconnect the appliance from the mains. Switch off at the wall and withdraw the plug from the socket or switch off the fuse of the electrical installation.</li> <li>■ Turn the lamp cover a quarter turn anti-clockwise to release it and then pull it together with its seal downwards to take it out.</li> <li>■ Replace the halogen lamp (Osram 66725 AM/A, 230 V, 25 W, G9).</li> <li>■ Refit the lamp cover together with its seal and turn clockwise to secure.</li> <li>■ Reconnect the appliance to the electricity supply.</li> </ul>

# Service

---

## Contact in the event of a fault

In the event of any faults which you cannot remedy yourself, please contact your Miele dealer or the Miele Customer Service Department.

You can book a Miele Customer Service Department call-out online at [www.miele.com/service](http://www.miele.com/service).

Contact information for the Miele Customer Service Department can be found at the end of this document.

Please quote the model identifier and serial number of your appliance (Fabr./SN/Nr.) when contacting the Miele Customer Service Department. This information can be found on the data plate.

Please note that telephone calls may be monitored and recorded for training purposes and that a call-out charge will be applied to service visits where the problem could have been resolved as described in this booklet.

This information is given on the data plate, which is visible on the front frame of the oven when the door is fully open.

## Warranty

For information on the appliance warranty specific to your country please contact Miele. See back cover for address.

In the UK, your appliance warranty is valid for 2 years from the date of purchase. However, you must activate your cover by calling 0330 160 6640 or registering online at [www.miele.co.uk](http://www.miele.co.uk).

## Installation dimensions

Dimensions are given in mm.

### Installation in a tall or base unit

When building the oven into a base unit underneath a hob, please also observe the installation instructions for the hob as well as the building-in depth required for the hob.

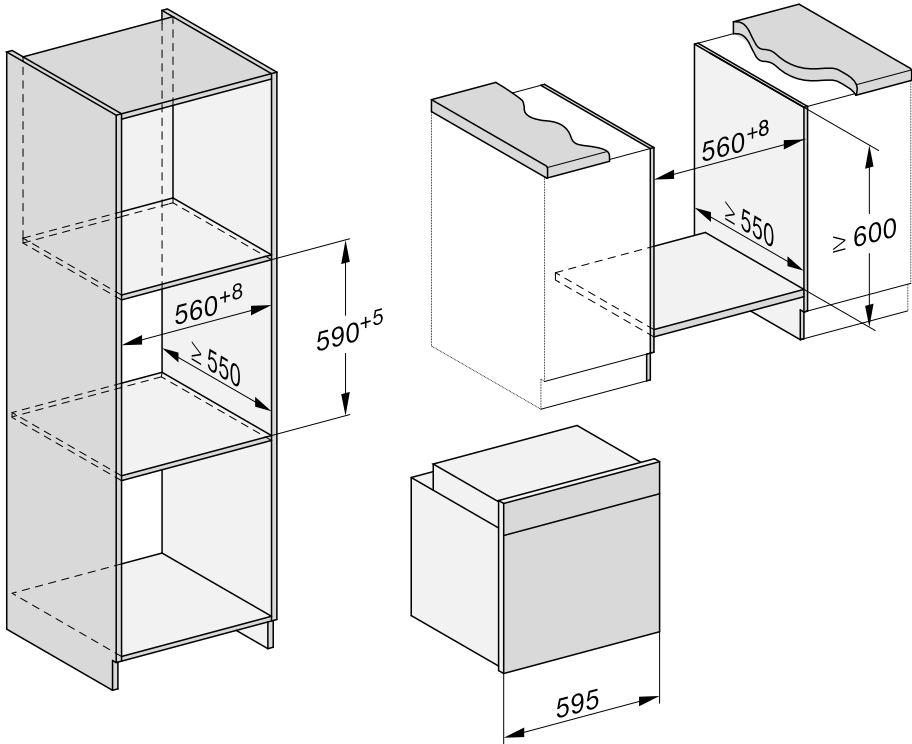

# Installation

## Side view

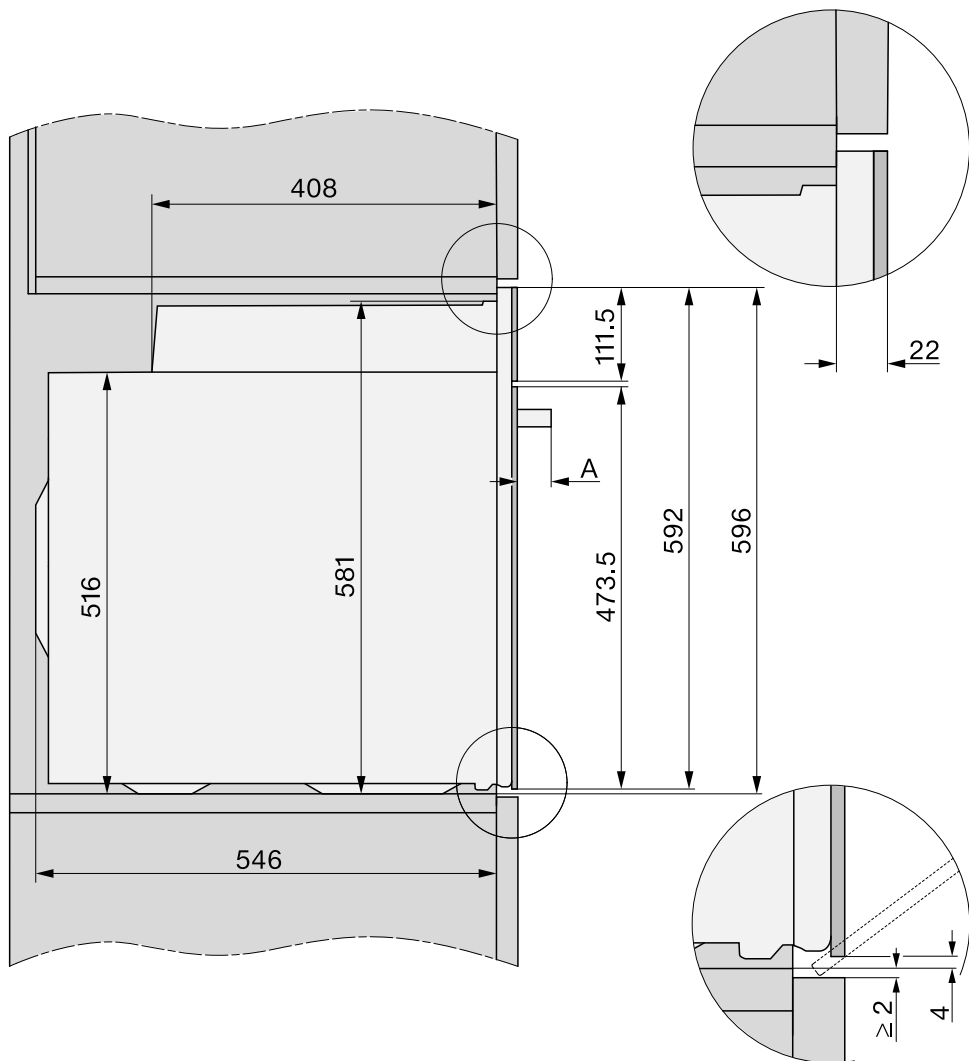

**A** H 71xx: 43 mm

H 72xx: 47 mm

## Connections and ventilation

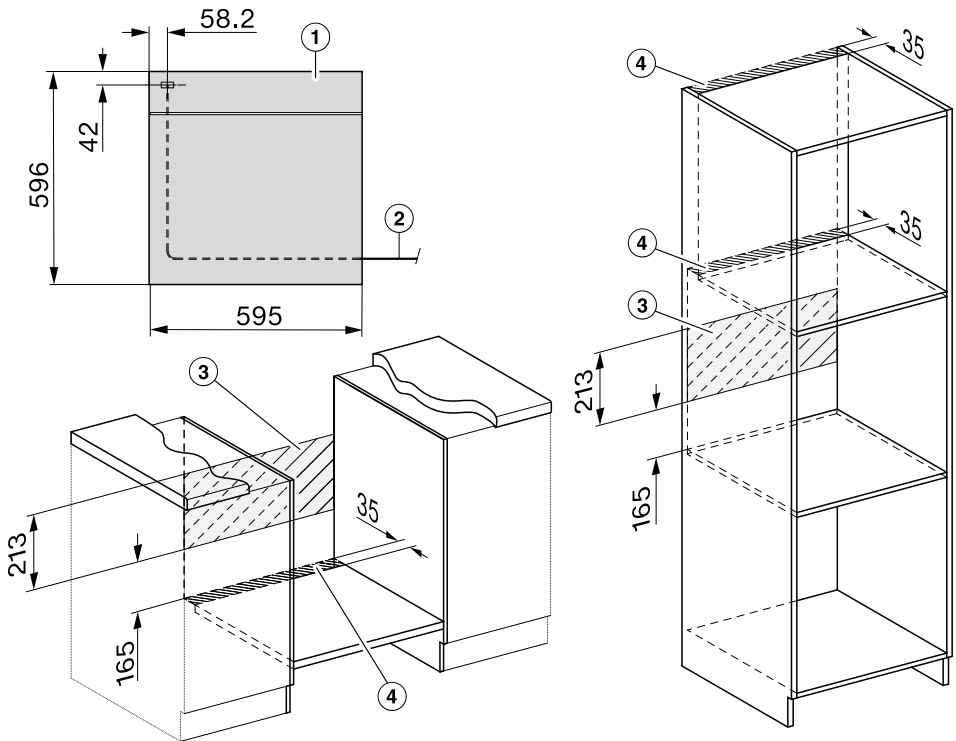

- ① Front view
- ② Mains connection cable, length = 1500 mm
- ③ No connections permitted in this area
- ④ Ventilation cut-out, min. 150 cm<sup>2</sup>

# Installation

## Installing the oven

For safety reasons, the oven may only be used when it has been fully installed.

The oven requires a sufficient supply of cool air for efficient operation. The required supply of cool air must not be excessively heated by other heat sources (e.g. solid fuel stoves).

The following must be observed when installing the appliance:  
Make sure that the shelf that the oven sits on does not touch the wall.  
Do not fit heat insulation strips to the side walls of the housing unit.

- Connect the oven to the electrical supply.

Carrying the oven by the door handle could damage the door.

Use the recessed grips on the side of the housing to carry the appliance.

It is a good idea to remove the door (see “Cleaning and care” – “Removing the door”) and the accessories before installing the appliance. This makes the oven lighter when you push it into the housing unit and you do not run the risk of lifting it by the door handle by mistake.

- Push the oven into the housing unit and align it.
- Open the door, if you have not removed it.

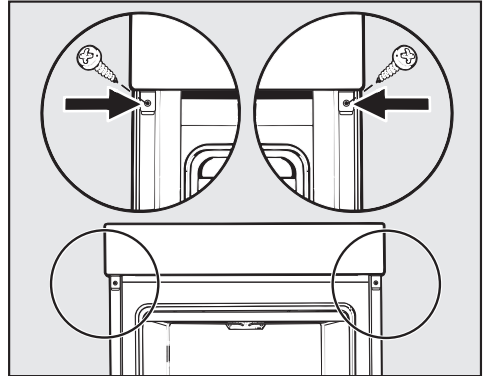

- Use the screws supplied to secure the oven to the side walls of the housing unit.
- Refit the door if necessary (see “Cleaning and care” – “Fitting the door”).

## Electrical connection



### Danger of injury!

Installation, repairs and other maintenance work by unqualified persons could be dangerous. Miele cannot be held liable for unauthorised work.

The appliance may only be connected to the mains electricity supply by a qualified electrician who is familiar with and complies with the national regulations and any additional regulations of the local electricity provider.

The appliance must be connected to an electrical system designed in accordance with VDE 0100.

**Connection to a switched socket** (in accordance with VDE 0701) is recommended as this provides easier access in the case of a service call.

If the appliance is **hardwired** or if the plug is not accessible, an additional means of disconnection must be provided for all poles.

Suitable means of disconnection include switches with an all-pole contact gap of at least 3 mm. These include circuit breakers, fuses and contactors (EN 60335).

**Connection data** is given on the data plate situated at the front of the oven compartment. Please ensure the connection data matches the household supply.

When contacting Miele, please quote the following:

- Model identifier
- Serial number
- Connection data (mains voltage/frequency/maximum rated load)

When replacing the cable supplied with another cable or changing the connection, only cable type H 05 VV-F with a suitable cross-sectional area (CSA) may be used.

Temporary or permanent operation on an autonomous power supply system or a power supply system that is not synchronised with the mains power supply (e.g. island networks, back-up systems) is possible. A prerequisite for operation is that the power supply system complies with the specifications of EN 50160 or an equivalent standard. The function and operation of the protective measures provided in the domestic electrical installation and in this Miele product must also be maintained in isolated operation or in operation that is not synchronised with the mains power supply, or these measures must be replaced by equivalent measures in the installation. As described, for example, in the current version of BS OHSAS 18001–2 ISO 45001.

## Oven

The wires in the mains lead are coloured as follows:

Green/yellow = earth

Blue = neutral

Brown = live

# Installation

 **WARNING - THIS APPLIANCE MUST BE EARTHED**

For extra safety it is advisable to protect the appliance with a suitable residual current device (RCD).  
Maximum connected load: see data plate.

## Electrical connection: Other countries

All electrical work should be carried out by a suitably qualified and competent Miele approved service technician in strict accordance with local and national safety regulations.

Connection should be made via a fused connection unit or a suitable isolator, which complies with national and local safety regulations, and the on/off switch should be easily accessible after the appliance has been installed.

If the switch is not accessible after installation (depending on country) an additional means of disconnection must be provided for all poles.

Switches with a minimum all-pole contact gap of 3 mm are suitable for isolating the appliance. These include circuit breakers, fuses and protective devices.

The voltage and rated load are given on the data plate situated at the front of the oven interior. Please ensure that these match the household mains supply.

For extra safety it is advisable to install a suitable residual current device (RCD) / ground fault interrupter (GFI). Contact a qualified electrician for advice.

If the cord is damaged a new cord must be fitted by a Miele approved service technician.

 **WARNING - THIS APPLIANCE MUST BE EARTHED**



















## Hong Kong









This appliance is supplied with a power cord with plug for connection to a 230 V, 50 Hz socket outlet.

## Taiwan

This appliance is supplied with a power cord with plug for connection to a 220 V, 60 Hz socket outlet.

## Batter

Cakes/biscuits (accessories)		Temperature [°C]		Shelf level <sup>5</sup>		Cooking duration [min]
				+HFC	-HFC	
Muffins (1 tray)		150–160	–	1	2	25–35
Muffins (2 trays)		150–160	–	1+3 <sup>3</sup>	1+3	30–40 <sup>4</sup>
Small cakes* (1 tray)		150	–	1	2	25–35
		160 <sup>2</sup>	–	2	3	20–30
Small cakes* (2 trays)		150 <sup>2</sup>	–	1+3 <sup>3</sup>	1+3	25–35
Madeira cake (baking and roasting rack, loaf tin, 30 cm) <sup>1</sup>		150–160	–	1	2	60–70
		155–165 <sup>2</sup>	–	1	2	60–70
Marble, nut cake (baking and roasting rack, loaf tin, 30 cm) <sup>1</sup>		150–160	–	1	2	55–65
		150–160	✓	1	2	60–70
Marble, nut cake (baking and roasting rack, ring tin/Bundt cake tin, Ø 26 cm) <sup>1</sup>		150–160	✓	1	2	55–65
		150–160	✓	1	2	60–70
Fresh fruit cake (1 tray)		155–165	–	1	2	40–50
		155–165	✓	1	1	55–65
Fresh fruit cake (baking and roasting rack, springform cake tin, Ø 26 cm) <sup>1</sup>		150–160	✓	1	2	55–65
		165–175 <sup>2</sup>	–	1	2	50–60
Flan base (baking and roasting rack, flan base tin, Ø 28 cm) <sup>1</sup>		150–160	–	1	2	25–35
		170–180 <sup>2</sup>	–	1	2	15–25























 Operating mode,  Temperature,  Booster,  Shelf level (+HFC: with FlexiClip runners HFC 70-C / -HFC: without FlexiClip runners HFC 70-C),  Cooking duration,  Fan plus,  Conventional heat,  On,  Off









\* The settings also apply for testing in accordance with EN 60350-1.

- 1 Use a dark coloured, matt baking tin and place it centrally on the baking and roasting rack.
- 2 Pre-heat the oven before putting food inside.
- 3 Fit the FlexiClip runners HFC 70-C (if available) onto the bottom shelf level.
- 4 Take the trays out of the oven early if the food is sufficiently browned before the specified cooking duration has elapsed.

# Cooking charts

## Shortcrust pastry





















Cakes/biscuits (accessories)		Temperature [°C]		 <sup>5</sup>		Cooking duration [min]
				+HFC	-HFC	
Biscuits (1 tray)		140–150	–	1	2	25–35
		150–160	–	1	2	25–35
Biscuits (2 trays)		140–150	–	1+3 <sup>3</sup>	1+3	25–35 <sup>4</sup>
Drop cookies* (1 tray)		140	–	1	2	35–45
		160 <sup>2</sup>	–	2	3	20–30
Drop cookies* (2 trays)		140	–	1+3 <sup>3</sup>	1+3	40–50 <sup>4</sup>
Flan base (baking and roasting rack, flan base tin, Ø 28 cm) <sup>1</sup>		150–160	–	1	2	35–45
		170–180 <sup>2</sup>	–	1	2	20–30
Cheesecake (baking and roasting rack, springform cake tin, Ø 26 cm) <sup>1</sup>		170–180	–	1	2	80–90
		150–160	–	1	2	80–90
Apple pie* (baking and roasting rack, springform cake tin, Ø 20 cm) <sup>1</sup>		160	–	1	2	80–100
		180	–	1	1	80–90
Apple pie, double crust (baking and roasting rack, springform cake tin, Ø 26 cm) <sup>1</sup>		180–190 <sup>2</sup>	–	1	2	60–70
		160–170	–	1	2	60–70
Fresh fruit cake, glazed (baking and roasting rack, springform cake tin, Ø 26 cm) <sup>1</sup>		170–180	–	1	2	60–70
		150–160	–	1	2	55–65
Fresh fruit cake, glazed (1 tray)		170–180	–	1	2	50–60
		160–170	–	1	2	45–55
Fruit flan (1 tray)		210–220 <sup>2</sup>	✓	–	1	55–65
		180–190	–	–	1	35–45







 Operating mode,  Temperature,  Booster, <sup>5</sup> Shelf level (+HFC: with FlexiClip runners HFC 70-C / -HFC: without FlexiClip runners HFC 70-C),  Cooking duration,  Fan plus,  Eco Fan heat,  Conventional heat,  Intensive bake, ✓ On, – Off

\* The settings also apply for testing in accordance with EN 60350-1.

- 1 Use a dark coloured, matt baking tin and place it centrally on the baking and roasting rack.
- 2 Pre-heat the oven before putting food inside.
- 3 Fit the FlexiClip runners HFC 70-C (if available) onto the bottom shelf level.
- 4 Take the trays out of the oven early if the food is sufficiently browned before the specified cooking duration has elapsed.

## Yeast dough

Cakes/biscuits (accessories)		Temperature [°C]		 <sup>5</sup>		Cooking duration [min]
				+HFC	-HFC	
Bundt cake (baking and roasting rack, Bundt cake tin, Ø 24 cm) <sup>1</sup>		150–160	–	1	2	50–60
		160–170	–	1	2	50–60
Stollen (1 tray)		150–160	–	1	2	55–65
		160–170	✓	1	2	55–65
Streusel cake with/without fruit (1 tray)		160–170	✓	1	2	40–50
		170–180	✓	2	3	45–55
Fresh fruit cake (1 tray)		160–170	✓	1	2	45–55
		170–180	✓	2	3	45–55
Apple turnovers/raisin whirls (1 tray)		160–170	✓	1	2	25–35
Apple turnovers/raisin whirls (2 trays)		160–170	✓	1+3 <sup>3</sup>	1+3	30–40 <sup>5</sup>
White bread, free-form (1 tray)		180–190	–	1	2	35–45
		190–200	–	1	2	30–40
White bread (baking and roasting rack, loaf tin, 30 cm) <sup>1</sup>		180–190	–	1	2	35–45
		190–200 <sup>2</sup>	✓	1	2	30–40
Wholegrain bread (baking and roasting rack, loaf tin, 30 cm) <sup>1</sup>		180–190	–	1	2	55–65
		200–210 <sup>2</sup>	✓	1	2	45–55
Proving yeast dough (baking and roasting rack)		30–35	–	– <sup>4</sup>	– <sup>4</sup>	–

 Operating mode,  Temperature,  Booster, <sup>5</sup> Shelf level (+HFC: with FlexiClip runners HFC 70-C / -HFC: without FlexiClip runners HFC 70-C),  Cooking duration,  Fan plus,  Conventional heat, ✓ On, – Off

- 1 Use a dark coloured, matt baking tin and place it centrally on the baking and roasting rack.
- 2 Pre-heat the oven before putting food inside.
- 3 Fit the FlexiClip runners HFC 70-C (if available) onto the bottom shelf level.
- 4 Place the baking and roasting rack on the floor of the oven and stand the bowl containing the dough on the rack. Depending on the size of the bowl, you may need to remove the side runners.
- 5 Take the trays out of the oven early if the food is sufficiently browned before the specified cooking duration has elapsed.

# Cooking charts

## Quark dough

Cakes/biscuits (accessories)		Temperature [°C]	Booster 	Shelf level <sup>5</sup> <sub>1</sub>		Cooking duration [min]
				+HFC	-HFC	
Fresh fruit cake (1 tray)		160–170	✓	1	2	40–50
		170–180	✓	2	3	50–60
Apple turnovers/raisin whirls (1 tray)		160–170	–	2	3	25–35
Apple turnovers/raisin whirls (2 trays)		150–160	✓	1+3 <sup>1</sup>	1+3	25–35 <sup>2</sup>

Operating mode, Temperature, Booster, Shelf level (+HFC with FlexiClip runners HFC 70-C / -HFC without FlexiClip runners HFC 70-C), Cooking duration, Fan plus, Conventional heat, ✓ On, – Off

- 1 Fit the FlexiClip runners HFC 70-C (if available) onto the bottom shelf level.
- 2 Take the trays out of the oven early if the food is sufficiently browned before the specified cooking duration has elapsed.













## Sponge mixture







Cakes/biscuits (accessories)		Temperature [°C]	Booster 	Shelf level <sup>5</sup> <sub>1</sub>		Cooking duration [min]
				+HFC	-HFC	
Sponge cake base (2 eggs) (baking and roasting rack, springform cake tin, Ø 26 cm) <sup>1</sup>		160–170 <sup>2</sup>	–	1	2	15–25
Sponge cake base (4–6 eggs) (baking and roasting rack, springform cake tin, Ø 26 cm) <sup>1</sup>		150–160 <sup>2</sup>	–	1	2	30–40
Whisked sponge* (baking and roasting rack, springform cake tin, Ø 26 cm) <sup>1</sup>		180	–	1	2	25–35
		150–170 <sup>2</sup>	–	1	2	25–45
Swiss roll sponge (1 tray)		180–190 <sup>2</sup>	–	1	2	10–20

Operating mode, Temperature, Booster, Shelf level (+HFC: with FlexiClip runners HFC 70-C / -HFC: without FlexiClip runners HFC 70-C), Cooking duration, Fan plus, Conventional heat, ✓ On, – Off

- \* The settings also apply for testing in accordance with EN 60350-1.  
Fit the FlexiClip runners HFC 70-C (if available).
- 1 Use a dark coloured, matt baking tin and place it centrally on the baking and roasting rack.
  - 2 Pre-heat the oven before putting food inside.

## Choux pastry, puff pastry, meringue

Cakes/biscuits (accessories)		 [°C]				 [min]
				+HFC	-HFC	
Choux buns (1 tray)		160–170	–	1	2	30–40
Pastry puffs (1 tray)		180–190	–	1	2	20–30
Pastry puffs (2 trays)		180–190	–	1+3 <sup>1</sup>	1+3	20–30 <sup>2</sup>
Macaroons (1 tray)		120–130	–	1	2	25–50
Macaroons (2 trays)		120–130	–	1+3 <sup>1</sup>	1+3	25–50 <sup>2</sup>
Meringues/pavlovas (1 tray of 6, each Ø 6 cm)		80–100	–	1	2	120–150
Meringues/pavlovas (2 trays of 6, each Ø 6 cm)		80–100	–	1+3 <sup>1</sup>	1+3	150–180

 Operating mode,  Temperature,  Booster,  Shelf level (+HFC: with FlexiClip runners HFC 70-C / -HFC: without FlexiClip runners HFC 70-C),  Cooking duration,  Fan plus,  On, – Off

<sup>1</sup> Fit the FlexiClip runners HFC 70-C (if available) onto the bottom shelf level.

<sup>2</sup> Take the trays out of the oven early if the food is sufficiently browned before the specified cooking duration has elapsed.

# Cooking charts

## Savoury dishes



















Food (accessories)		Temperature [°C]		Shelf level <sup>5</sup> <sub>1</sub>		Cooking duration [min]
				+HFC	-HFC	
Savoury flan (1 tray)		220–230 <sup>1</sup>	✓	–	1	35–45
		180–190	–	–	1	30–40
Onion tart (1 tray)		180–190 <sup>1</sup>	✓	1	2	25–35
		170–180	–	1	2	30–40
Pizza, yeast dough (1 tray)		170–180	✓	1	2	25–35
		210–220 <sup>1</sup>	–	1	2	20–30
Pizza, quark dough (1 tray)		170–180	✓	1	2	25–35
		190–200 <sup>1</sup>	✓	1	2	25–35
Frozen pizza, pre-cooked (baking and roasting rack)		200–210	–	1	2	20–25
Toast* (baking and roasting rack)		300	–	–	3	5–8
Baked dishes/gratins (e.g. toast) (baking and roasting rack on universal tray)		275 <sup>2</sup>	–	2	3	3–6
Grilled vegetables (baking and roasting rack on universal tray)		275 <sup>2</sup>	–	3	4	5–10 <sup>3</sup>
		250 <sup>2</sup>	–	3	3	5–10 <sup>3</sup>
Ratatouille (1 universal tray)		180–190	–	2	2	40–60

Operating mode, Temperature, Booster, Shelf level (+HFC: with FlexiClip runners HFC 70-C / -HFC: without FlexiClip runners HFC 70-C), Cooking duration, Conventional heat, Intensive bake, Fan plus, Eco Fan heat, Full grill, Fan grill, ✓ On, – Off

\* The settings also apply for testing in accordance with EN 60350-1.

- 1 Pre-heat the oven before putting food inside.
- 2 Pre-heat the oven for 5 minutes before putting food inside.
- 3 If possible, turn the food halfway through the cooking duration.

## Beef

Food (accessories)		 [°C]		 5 1	 [min]	 <sup>10</sup> [°C]
Braised beef, approx. 1 kg (oven dish with lid)	 <sup>2</sup>	150–160 <sup>3</sup>	✓	2 <sup>6</sup>	120–130 <sup>7</sup>	–
	 <sup>2</sup>	170–180 <sup>3</sup>	✓	2 <sup>6</sup>	120–130 <sup>7</sup>	–
	 <sup>2</sup>	180–190	–	2 <sup>6</sup>	160–180 <sup>8</sup>	–
Fillet of beef, approx. 1 kg (universal tray)	 <sup>2</sup>	180–190 <sup>3</sup>	✓	2 <sup>6</sup>	25–60	45–75
Fillet of beef (rare), approx. 1 kg <sup>1</sup>	 <sup>2</sup>	80–85 <sup>4</sup>	–	2 <sup>6</sup>	70–80	45–48
Fillet of beef (medium), approx. 1 kg <sup>1</sup>	 <sup>2</sup>	90–95 <sup>4</sup>	–	2 <sup>6</sup>	80–90	54–57
Fillet of beef (well done), approx. 1 kg <sup>1</sup>	 <sup>2</sup>	95–100 <sup>4</sup>	–	2 <sup>6</sup>	110–130	63–66
Roast beef, approx. 1 kg (universal tray)	 <sup>2</sup>	180–190 <sup>3</sup>	✓	2 <sup>6</sup>	35–65	45–75
Roast beef (rare), approx. 1 kg <sup>1</sup>	 <sup>2</sup>	80–85 <sup>4</sup>	–	2 <sup>6</sup>	80–90	45–48
Roast beef (medium), approx. 1 kg <sup>1</sup>	 <sup>2</sup>	90–95 <sup>4</sup>	–	2 <sup>6</sup>	110–120	54–57
Roast beef (well done), approx. 1 kg <sup>1</sup>	 <sup>2</sup>	95–100 <sup>4</sup>	–	2 <sup>6</sup>	130–140	63–66
Burger, meat patties* (baking and roasting rack on shelf level 4 and universal tray on shelf level 1)		300 <sup>5</sup>	–	4	15–25 <sup>9</sup>	–















 Operating mode,  Temperature,  Booster,  5  
1 Shelf level,  Cooking duration,  Core temperature,  Auto roast,  Conventional heat,  Eco Fan heat,  Full grill, ✓ On, – Off

\* The settings also apply for testing in accordance with EN 60350-1.

- Use the baking and roasting rack and universal tray.
- Sear the meat on the hob first.
- Pre-heat the oven before putting food inside.
- Pre-heat the oven at 120 °C for 15 minutes. Reduce the temperature when you place the food in the oven.
- Pre-heat the oven for 5 minutes before putting food inside.
- Fit the FlexiClip runners HFC (if available).
- Roast with the lid on to start with. Remove the lid 90 minutes into the cooking duration and add approx. 0.5 litres of liquid.
- Roast with the lid on to start with. Remove the lid 100 minutes into the cooking duration and add approx. 0.5 litres of liquid.
- Turn the food halfway through cooking.
- If you are using a food probe, you can use the core temperature shown.

# Cooking charts



















## Veal

Food (accessories)		 [°C]		 5 1	 [min]	 7 [°C]
Braised veal, approx. 1.5 kg (oven dish with lid)	 2	160–170 <sup>3</sup>	✓	2 <sup>5</sup>	120–130 <sup>6</sup>	–
	 2	170–180 <sup>3</sup>	✓	2 <sup>5</sup>	120–130 <sup>6</sup>	–
Fillet of veal, approx. 1 kg (universal tray)	 2	160–170 <sup>3</sup>	✓	2 <sup>5</sup>	30–60	45–75
Fillet of veal (pink), approx. 1 kg <sup>1</sup>	 2	80–85 <sup>4</sup>	–	2 <sup>5</sup>	50–60	45–48
Fillet of veal (medium), approx. 1 kg <sup>1</sup>	 2	90–95 <sup>4</sup>	–	2 <sup>5</sup>	80–90	54–57
Fillet of veal (well done), approx. 1 kg <sup>1</sup>	 2	95–100 <sup>4</sup>	–	2 <sup>5</sup>	90–100	63–66
Saddle of veal (pink), approx. 1 kg <sup>1</sup>	 2	80–85 <sup>4</sup>	–	2 <sup>5</sup>	80–90	45–48
Saddle of veal (medium), approx. 1 kg <sup>1</sup>	 2	90–95 <sup>4</sup>	–	2 <sup>5</sup>	100–130	54–57
Saddle of veal (well done), approx. 1 kg <sup>1</sup>	 2	95–100 <sup>4</sup>	–	2 <sup>5</sup>	130–140	63–66

 Operating mode,  Temperature,  Booster,  Shelf level,  Cooking duration,  Core temperature,  Auto roast,  Conventional heat, ✓ On, – Off

- 1 Use the baking and roasting rack and universal tray.
- 2 Sear the meat on the hob first.
- 3 Pre-heat the oven before putting food inside.
- 4 Pre-heat the oven at 120 °C for 15 minutes. Reduce the temperature when you place the food in the oven.
- 5 Fit the FlexiClip runners HFC (if available).
- 6 Roast with the lid on to start with. Remove the lid 90 minutes into the cooking duration and add approx. 0.5 litres of liquid.
- 7 If you are using a food probe, you can use the core temperature shown.

## Pork













Food (accessories)		 [°C]		 5 <sub>1</sub>	 [min]	 <sup>10</sup> [°C]
Pork joint/pork neck roast, approx. 1 kg (oven dish with lid)		160–170	✓	2 <sup>5</sup>	130–140 <sup>6</sup>	80–90
		170–180	✓	2 <sup>5</sup>	130–140 <sup>6</sup>	80–90
Pork joint with crackling, approx. 2 kg (oven dish)		180–190	✓	2 <sup>5</sup>	130–150 <sup>7</sup>	80–90
		190–200	✓	2 <sup>5</sup>	130–150 <sup>7</sup>	80–90
Pork tenderloin, approx. 350 g <sup>1</sup>	 <sup>2</sup>	90–100 <sup>3</sup>	–	2 <sup>5</sup>	70–90	60–69
Ham roast, approx. 1.5 kg (oven dish with lid)		160–170	–	2 <sup>5</sup>	130–160 <sup>8</sup>	80–90
Gammon joint, approx. 1 kg (universal tray)		150–160	✓	2 <sup>5</sup>	50–60	63–68
Gammon joint, approx. 1 kg <sup>1</sup>	 <sup>2</sup>	95–105 <sup>3</sup>	–	2 <sup>5</sup>	140–160	63–66
Meat loaf, approx. 1 kg (universal tray)		170–180	✓	2 <sup>5</sup>	60–70 <sup>7</sup>	80–85
		190–200	✓	2 <sup>5</sup>	70–80 <sup>7</sup>	80–85
Bacon <sup>1</sup>		300 <sup>4</sup>	–	4	3–5	–
Bratwurst <sup>1</sup>		220 <sup>4</sup>	–	3 <sup>5</sup>	8–15 <sup>9</sup>	–







 Operating mode,  Temperature,  Booster,  5<sub>1</sub> Shelf level,  Cooking duration,  Core temperature,  Auto roast,  Conventional heat,  Fan plus,  Eco Fan heat,  Full grill, ✓ On, – Off

- Use the baking and roasting rack and universal tray.
- Sear the meat on the hob first.
- Pre-heat the oven at 120 °C for 15 minutes. Reduce the temperature when you place the food in the oven.
- Pre-heat the oven for 5 minutes before putting food inside.
- Fit the FlexiClip runners HFC (if available).
- Roast with the lid on to start with. Remove the lid 60 minutes into the cooking duration and add approx. 0.5 litres of liquid.
- Add approx. 0.5 litres of liquid halfway through the cooking duration.
- Roast with the lid on to start with. Remove the lid 100 minutes into the cooking duration and add approx. 0.5 litres of liquid.
- Turn the food halfway through cooking.
- If you are using a food probe, you can use the core temperature shown.

# Cooking charts















## Lamb, game











Food (accessories)		 [°C]		 5 1	 [min]	 <sup>6</sup> [°C]
Leg of lamb on the bone, approx. 1.5 kg (oven dish with lid)		170–180	–	2 <sup>4</sup>	100–120 <sup>5</sup>	64–82
Saddle of lamb, off the bone (universal tray)	 <sup>1</sup>	180–190 <sup>2</sup>	✓	2 <sup>4</sup>	10–20	53–80
Saddle of lamb, off the bone (baking and roasting rack and universal tray)	 <sup>1</sup>	95–105 <sup>3</sup>	–	2 <sup>4</sup>	40–60	54–66
Saddle of venison, off the bone (universal tray)	 <sup>1</sup>	160–170 <sup>2</sup>	–	2 <sup>4</sup>	70–90	60–81
Roebuck saddle, off the bone (universal tray)	 <sup>1</sup>	140–150 <sup>2</sup>	–	2 <sup>4</sup>	25–35	60–81
Leg of wild boar, off the bone, approx. 1 kg (oven dish with lid)	 <sup>1</sup>	170–180	–	2 <sup>4</sup>	100–120 <sup>5</sup>	80–90

 Operating mode,  Temperature,  Booster,  Shelf level,  Cooking duration,  Core temperature,  Conventional heat, ✓ On, – Off

- 1 Seal the meat on the hob first.
- 2 Pre-heat the oven before putting food inside.
- 3 Pre-heat the oven at 120 °C for 15 minutes. Reduce the temperature when you place the food in the oven.
- 4 Fit the FlexiClip runners HFC (if available).
- 5 Roast with the lid on to start with. Remove the lid 50 minutes into the cooking duration and add approx. 0.5 litres of liquid.
- 6 If you are using a food probe, you can use the core temperature shown.

## Poultry, fish

Food (accessories)		 [°C]		 5 1	 [min]	 7 [°C]
Poultry, 0.8–1.5 kg (universal tray)		170–180	✓	2 <sup>3</sup>	55–65	85–90
Chicken, approx. 1.2 kg (baking and roasting rack on universal tray)		180–190 <sup>1</sup>	–	2 <sup>3</sup>	55–65 <sup>4</sup>	85–90
Poultry, approx. 2 kg (oven dish)		180–190	✓	2 <sup>3</sup>	100–120 <sup>5</sup>	85–90
		190–200	✓	2 <sup>3</sup>	110–130 <sup>5</sup>	85–90
Poultry, approx. 4 kg (oven dish)		160–170	✓	2 <sup>3</sup>	180–200 <sup>6</sup>	90–95
		180–190	✓	2 <sup>3</sup>	180–200 <sup>6</sup>	90–95
Fish, 200–300 g (e.g. trout) (universal tray)		210–220 <sup>2</sup>	–	2 <sup>3</sup>	15–25	75–80
Fish, 1–1.5 kg (e.g. salmon trout) (universal tray)		210–220 <sup>2</sup>	–	2 <sup>3</sup>	30–40	75–80
Fish fillet in foil, 200–300 g (universal tray)		200–210	–	2 <sup>3</sup>	25–30	75–80

 Operating mode,  Temperature,  Booster,  Shelf level,  Cooking duration,  Core temperature,  Auto roast,  Fan grill,  Conventional heat,  Eco Fan heat, ✓ On, – Off

- 1 Pre-heat the oven for 5 minutes before putting food inside.
- 2 Pre-heat the oven before putting food inside.
- 3 Fit the FlexiClip runners HFC (if available).
- 4 Turn the food half way through grilling.
- 5 Add approx. 0.25 litres of liquid at the start of the cooking process.
- 6 Add approx. 0.5 litres of liquid after 30 minutes.
- 7 If you are using a food probe, you can use the core temperature shown.

# Notes for test institutes

## Test food according to EN 60350-1

Test food (accessories)		Temperature [°C]		Shelf level <sup>5 6</sup>		Cooking duration [min]
				+HFC	-HFC	
Small cakes (1 baking tray <sup>1</sup> )		150	-	1	2	25-35
		160 <sup>4</sup>	-	2	3	20-30
Small cakes (2 baking trays <sup>1</sup> )		150 <sup>4</sup>	-	1+3 <sup>7</sup>	1+3	25-35
Drop cookies (1 baking tray <sup>1</sup> )		140	-	1	2	35-45
		160 <sup>4</sup>	-	2	3	20-30
Drop cookies (2 baking trays <sup>1</sup> )		140	-	1+3 <sup>7</sup>	1+3	40-50 <sup>8</sup>
Apple pie (baking and roasting rack <sup>1</sup> , springform cake tin <sup>2</sup> , Ø 20 cm)		160	-	1	2	80-100
		180	-	1	1	80-90
Whisked sponge (baking and roasting rack <sup>1</sup> , springform cake tin <sup>2</sup> , Ø 26 cm)		180	-	1	2	25-35
		150-170 <sup>4</sup>	-	1	2	25-45
Toast (baking and roasting rack <sup>1</sup> )		300	-	--	3	5-8
Burger (baking and roasting rack <sup>1</sup> on shelf level 4 and universal tray <sup>1</sup> on shelf level 1)		300 <sup>5</sup>	-	--	4	15-25 <sup>9</sup>

Operating mode, Temperature, Booster, Shelf level (+HFC: with FlexiClip runners HFC 70-C / -HFC: without FlexiClip runners HFC 70-C), Cooking duration, Fan plus, Conventional heat, Full grill, ✓ On, - Off

- <sup>1</sup> Only use original Miele accessories.
- <sup>2</sup> Use a dark matt springform cake tin.  
Place the springform cake tin centrally on the baking and roasting rack.
- <sup>3</sup> In general, if a range of temperatures is given, it is best to select the lower temperature and to check the food after the shortest cooking duration.
- <sup>4</sup> Pre-heat the oven before putting food inside.
- <sup>5</sup> Pre-heat the oven for 5 minutes before putting food inside.
- <sup>6</sup> Fit the FlexiClip runners HFC 70-C (if available).
- <sup>7</sup> Fit the FlexiClip runners HFC 70-C (if available) onto the bottom shelf level. If you have several pairs of FlexiClip runners, fit only one pair.
- <sup>8</sup> Take the trays out of the oven early if the food is sufficiently browned before the specified cooking duration has elapsed.
- <sup>9</sup> Turn the food halfway through cooking.

## Energy efficiency class according to EN 60350-1

The energy efficiency class is determined in accordance with EN 60350-1.

Energy efficiency class: A+

Please observe the following when conducting testing:

- Testing is undertaken using the Eco Fan heat  function.
- Select the Lighting | “On” for 15 seconds setting (see “Settings – “Lighting”).
- Only accessories that are required for testing should be in the oven compartment during tests.

Do not use other accessories that might be available such as FlexiClip runners or catalytic enamelled panels (e.g. side panels or roof liners).

- An important pre-condition for determining the energy efficiency class is that the door must be tightly shut during testing.

Depending on which measurement devices are used, the functioning of the door seal can be affected to a greater or lesser extent. This will have a negative impact on the test results.

Pushing against the door will compensate for this. In certain unfavourable circumstances, suitable technical aids may also be necessary for this. This issue does not occur in normal use.

## Data sheet for household ovens

In acc. with delegated regulation (EU) No. 65/2014 and regulation (EU) No. 66/2014

<b>MIELE</b>	
<b>Model name/identifier</b>	H 7260 BP
Energy efficiency index/cavity (EEI <sub>cavity</sub> )	81,7
Energy efficiency class/cavity	
A+++ (most efficient) to D (least efficient)	A+
Energy consumption per cycle for each cavity in conventional mode	1,10 kWh
Energy consumption per cycle for each cavity in fan-forced convection mode	0,71 kWh
Number of cavities	1
Heat source(s) per cavity	electric
Volume of cavity	76 l
Mass of the appliance	47,0 kg



## United Kingdom

Miele Co. Ltd., Fairacres, Marcham Road, Abingdon, Oxon, OX14 1TW

Tel: 0330 160 6600, Internet: [www.miele.co.uk/service](http://www.miele.co.uk/service), E-mail: [info@miele.co.uk](mailto:info@miele.co.uk)

### Australia

Miele Australia Pty. Ltd.

ACN 005 635 398

ABN 96 005 635 398

Level 4, 141 Camberwell Road

Hawthorn East, VIC 3123

Tel: 1300 464 353

Internet: [www.miele.com.au](http://www.miele.com.au)

### China Mainland

Miele Electrical Appliances Co., Ltd.

1-3 Floor, No. 82 Shi Men Yi Road

Jing' an District

200040 Shanghai, PRC

Tel: +86 21 6157 3500

Fax: +86 21 6157 3511

E-mail: [info@miele.cn](mailto:info@miele.cn),

Internet: [www.miele.cn](http://www.miele.cn)

### Hong Kong, China

Miele (Hong Kong) Ltd.

41/F - 4101, Manhattan Place

23 Wang Tai Road

Kowloon Bay, Hong Kong

Tel: (852) 2610 1025

Fax: (852) 3579 1404

Email:

[customerservices@miele.com.hk](mailto:customerservices@miele.com.hk)

Website: [www.miele.hk](http://www.miele.hk)

### India

Miele India Pvt. Ltd.

1st Floor, Copia Corporate Suites,

Commercial Plot 9,

Mathura Road, Jasola,

New Delhi - 110025

E-mail: [customercare@miele.in](mailto:customercare@miele.in)

Website: [www.miele.in](http://www.miele.in)

### Ireland

Miele Ireland Ltd.

2024 Bianconi Avenue

Citywest Business Campus

Dublin 24

Tel: (01) 461 07 10

Fax: (01) 461 07 97

E-Mail: [info@miele.ie](mailto:info@miele.ie)

Internet: [www.miele.ie](http://www.miele.ie)

### Malaysia

Miele Sdn Bhd

Suite 12-2, Level 12

Menara Sapura Kencana

Petroleum

Solaris Dutamas No. 1

Jalan Dutamas 1

50480 Kuala Lumpur, Malaysia

Phone: +603-6209-0288

Fax: +603-6205-3768

### New Zealand

Miele New Zealand Limited

IRD 98 463 631

8 College Hill

Freemans Bay, Auckland 1011

New Zealand

Tel: 0800 464 353

Internet: [www.miele.co.nz](http://www.miele.co.nz)

### Singapore

Miele Pte. Ltd.

29 Media Circle

#11-04 ALICE@Mediapolis

Singapore 138565

sTel: +65 6735 1191

Fax: +65 6735 1161

E-Mail: [info@miele.com.sg](mailto:info@miele.com.sg)

Internet: [www.miele.sg](http://www.miele.sg)

### South Africa

Miele (Pty) Ltd.

63 Peter Place

Bryanston 2194

P.O. Box 69434

Bryanston 2021

Tel: (011) 875 9000

Fax: (011) 875 9035

E-mail: [info@miele.co.za](mailto:info@miele.co.za)

Internet: [www.miele.co.za](http://www.miele.co.za)

### Thailand

Miele Appliances Ltd.

BHIRAJ TOWER at EmQuartier

43rd Floor Unit 4301-4303

689 Sukhumvit Road

North Klongton Sub-District

Vadhana District

Bangkok 10110, Thailand

### United Arab Emirates

Miele Appliances Ltd.

Showroom 1

Eiffel 1 Building

Sheikh Zayed Road, Umm Al Sheif

P.O. Box 114782 - Dubai

Tel. +971 4 3044 999

Fax. +971 4 3418 852

800-MIELE (64353)

E-Mail: [info@miele.ae](mailto:info@miele.ae)

Website: [www.miele.ae](http://www.miele.ae)

**Manufacturer:** Miele & Cie. KG, Carl-Miele-Straße 29, 33332 Gütersloh, Germany

H 7260 BP

en-GB

M.-Nr. 11 190 701 / 02