

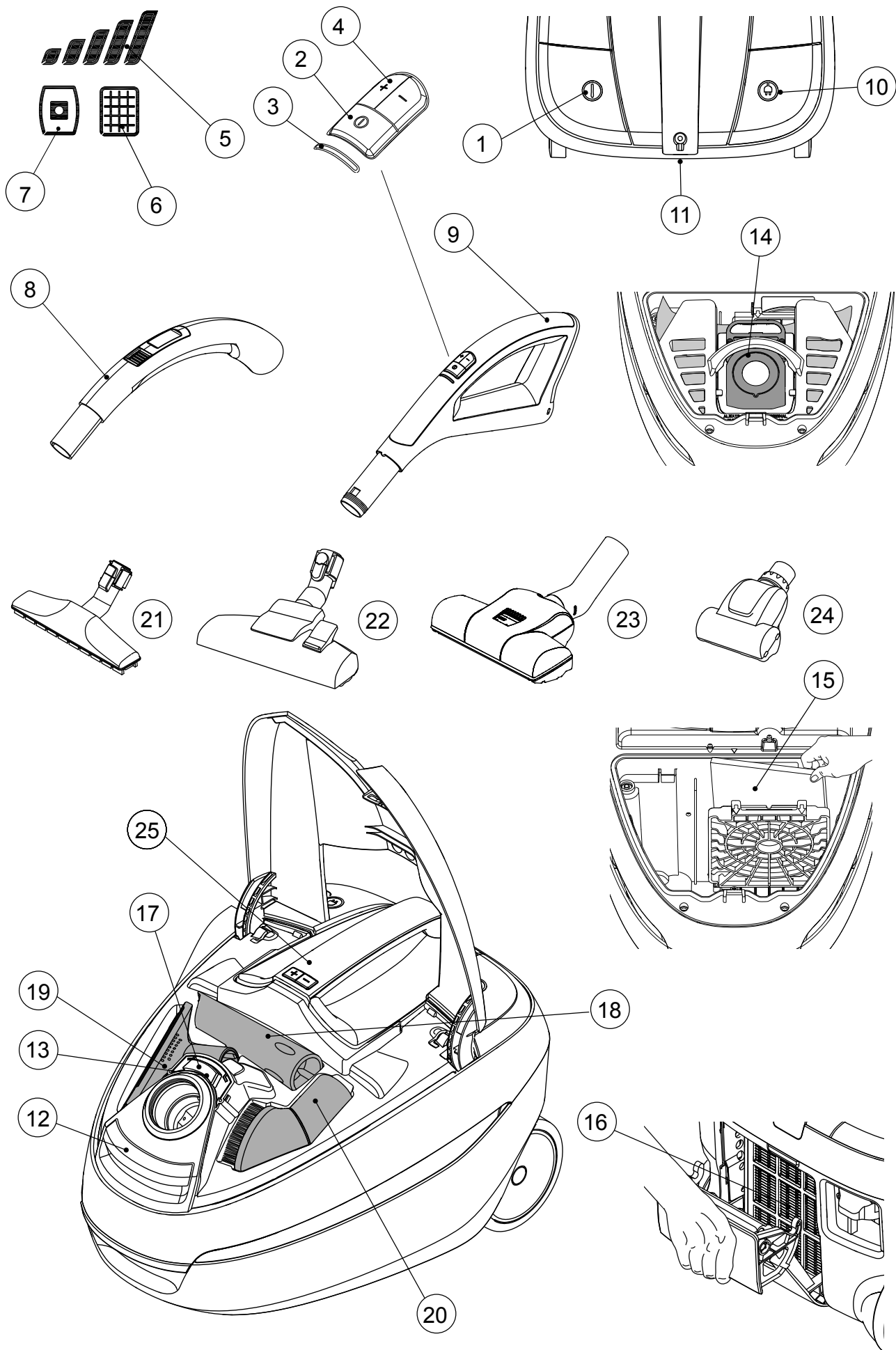

## Instructions for use





(EN)	Instructions for use .....	4- 10
(DE)	Betriebsanleitung.....	11- 17
(FR)	Instructions d'utilisation .....	18- 24
(ES)	Instrucciones de manejo.....	25- 31
(PT)	Instruções de operação .....	32- 38
(IT)	Istruzioni sull'uso .....	39- 45
(NL)	Gebruiksaanwijzing .....	46- 52
(SV)	Bruksanvisning .....	53- 59
(NO)	Instruksjonsbok.....	60- 66
(DA)	Brugsvejledning .....	67- 73
(FI)	Käyttöohje.....	74- 80
(KO)	사용 방법 .....	81- 86
(ET)	Kasutusjuhend.....	87- 92
(LV)	Lietošanas instrukcijas .....	93- 99
(LT)	Naudojimo instrukcija .....	100- 105
(PL)	Instrukcja obsługi.....	106- 112
(CS)	Návod k použití.....	113- 119
(SK)	Návod na použitie.....	120- 126
(HU)	Használati utasítás .....	127- 133
(SL)	Navodila za uporabo.....	134- 140
(EL)	Οδηγίες χρήσης.....	141- 147
(TR)	Kullanım Kılavuzu.....	148- 155
(RU)	Эксплуатации .....	156- 164
	Illustrations .....	165- 167

## Dear Nilfisk customer



Congratulations on the purchase of your new Nilfisk vacuum cleaner.

Prior to using the appliance for the first time, be sure to read this document through and keep it ready to hand.

## Symbols used to mark instructions



### WARNING

Danger that can lead to serious injuries and damage.

## Table of contents

Overview - (illustrations inside front cover).....	4
Display symbols on carrying handle .....	4
Safety Instructions .....	4
Instructions for use .....	5
Cleaning tips .....	7
Trouble-shooting .....	7
Service and maintenance .....	7
Guarantee and Service.....	7
WEEE .....	8
Technical Specifications .....	9
Declaration of Conformity .....	10

## Overview - (illustrations inside front cover)

1 On/off button
2 On/off button, remote control
3 On/off indicator, electronic
4 Power level adjustment, remote control
5 Power level indicator, electronic
6 HEPA filter indicator, electronic
7 Dust bag indicator, electronic
8 Manual handle
9 Remote handle
10 Cable rewind button
11 Parking bracket
12 Open/close button, dust container
13 Dust bag indicator (Classic models)
14 Dust bag
15 Pre-filter
16 HEPA filter
17 Open/close button, accessory lid
18 Crevice nozzle
19 Upholstery nozzle
20 Brush nozzle
21 Hard floor nozzle (not standard on all models)
22 Combination nozzle
23 Turbo nozzle (not standard on all models)
24 Mini Turbo nozzle (not standard on all models)
25 Carrying handle

## Display symbols on carrying handle

(not standard on all models)



The dust bag is full and needs to be changed.



The HEPA filter needs to be changed. Flashing indicator - early warning, the HEPA filter soon needs to be changed.



Machine ON.



Indicates current power level.

Specifications and details are subject to change without prior notice.

## Safety Instructions



### WARNING

- Do not use the machine without dust bag and filters properly fitted.
- This machine is not intended for the suction of hazardous materials or gas, doing so may expose people to serious health risks.
- The machine must not be used for the suction of water or other liquids.
- Do not pick up sharp objects such as needles or pieces of glass.
- Do not pick up anything that is burning or smoking such as cigarettes, matches or hot ashes.
- Use and store this machine indoors and in a dry environment, 0 °C to 60 °C.
- Do not use the machine outdoors.
- Do not handle the machine with wet hands.
- Turn off the machine before unplugging.

- To unplug, grasp the plug, not by pulling on the electric cable. Do not carry or pull the machine by the electric cable.
- The machine must not be used if the electric cable shows any sign of damage. Regularly inspect the electric cable for damage, in particular if it has been crushed, shut in a door or run over.
- Do not use the machine if it appears faulty. Have the machine inspected by an authorized service centre if the machine has been dropped, damaged, left outdoors or has been exposed to water.
- No changes or modifications to the mechanical or electrical safety devices should be made.
- All repair must be carried out by an authorized service centre.
- Use only original dust bags, original filters and original accessories from your local dealer. Use of unauthorized dust bags and filters will void the warranty.
- Turn off the machine and unplug before starting dust bag or filter change, grasp the plug, not by pulling on the electric cable.
- This appliance can be used by children aged from 8 years and above and persons with reduced physical, sensory or mental capabilities or lack of experience and knowledge if they have been given supervision or instruction concerning use of the appliance in a safe way and understand the hazards involved.
- Children shall be supervised to make sure that they do not play with the appliance.
- Cleaning and user maintenance shall not be made by children without supervision.
- If the supply electric cable is damaged, it must be replaced by the manufacturer, its service agent or similarly qualified persons in order to avoid hazard.
- Different types of batteries or new and used batteries are not to be mixed.
- Exhausted batteries are to be removed from the appliance and safely disposed of.
- If the appliance is to be stored unused for a long period, the batteries should be removed.
- The supply terminals are not to be short-circuited.

## Instructions for use

Before using the machine make sure that the voltage shown on the rating plate underneath the machine corresponds with the mains voltage.

The machine is supplied with dust bag and pre-filter.

Numbers **x** refer to illustrations on pages 165-167.

## Start and stop

### Start

Pull out the electric cable and plug the machine to a wall socket.

### On/off:

Option 1: Use on/off on machine

Option 2: Use on/off on the remote control (bend end) - only superior model.

Power can be adjusted between 5 power levels. Current setting is shown on the carrying handle of the machine (only for Comfort/Superior). On the Superior model the power setting can also be adjusted on the remote control (hose handle).

## Stop

Turn off the machine and unplug. Unplug by grasping the plug, not by pulling on the electric cable.

## Connecting hose, tube and nozzles

1. Insert the hose connector into the suction inlet until it engages by a "click" sound.
2. Connect the hose handle to the tube and twist until they engage with a click.
3. Connect the tube and nozzle and twist until they engage with a click.
4. The tube is telescopic and can be adjusted to your height.  
Pull out the adjusting handle to extend the tube, and pull back to shorten to desired length.

## Disengage

- Disengage the nozzle from the tube by pressing the button.
- Disengage the hose handle from the tube by pressing the button.
- To remove the hose connection from the suction inlet, press button and disengage the hose.

## Change of dust bag and filters

The size and quality of the dust bag and filters affect the machine efficiency. Use of non original dust bags or non original filters can cause restricted air flow which may lead to machine overload. Using non-original dust bag or filters will void the warranty.

The machine is a completely air tight construction. This ensures that air and dirt going into the machine, can only get out through the HEPA filter in the end.

## Changing the dust bag

2. The dust bag indicator shows when to change the dust bag. Always use original dust bags.
1. Open the lid by pushing at the latch release in the direction of the arrows.
2. Remove dust bag holder from dust compartment.
3. Remove dust bag from holder. The dust bag can be closed by pulling the collar handle.
4. Insert the new dust bag by guiding the collar into the tracks of the bag holder.
5. Place the bag holder in the dust compartment. Check that the dust bag is correctly fitted into dust compartment.

## Changing the pre-filter

3. The pre-filter protects the motor by absorbing micro-particles that the dust bag can not keep. Change the pre-filter with every fourth dust bag. The pre-filter is located behind the

dust bag. Always use original filters.

1. Open the lid by pulling up at the latch release.
2. Remove bag holder with bag from dust compartment.
3. Open pre-filter hatch by pulling handle.
4. Take out the pre-filter.
5. Fit the new pre-filter (ensure that the text is readable) and close the pre-filter hatch.
6. Place the bag holder in the dust compartment. Check that the dust bag is correctly fitted into dust compartment.

## Changing the HEPA filter

4. The HEPA filter cleans the exhaust air from micro particles the dust bag can not keep. The HEPA filter can not be brushed or washed clean. Comfort and Superior models have a HEPA filter indicator that shows when to change the HEPA filter. For Classic models, change HEPA filter for every 4th dust bag change. Always use original dust bags and filters.

1. Open the lid on the back of the machine by pulling the tap.
2. Take out the HEPA filter.
3. Insert the new HEPA filter. Check that the HEPA filter is correctly fitted. **NB:** Only touch the filter plastic frame
4. Put the lid back and close by pushing the tap in. **NB:** Assure lid is fully closed.

## Adjust the suction power

All models have a five step adjustment on the carrying handle. The suction power can also be adjusted on the remote handle of the Superior models.

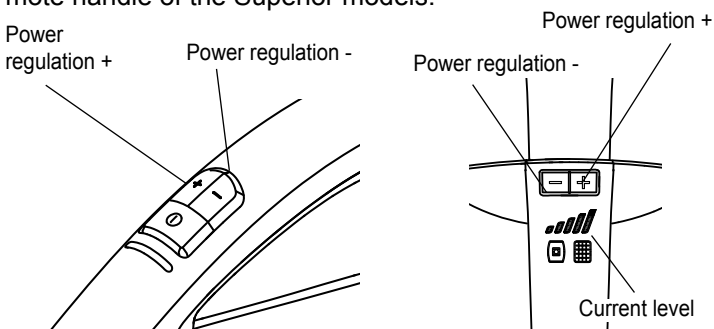

Current level is shown on the carrying handle on Superior/Comfort models.

## Battery replacement in hose handle:

1. Open the lid of the battery holder by sliding the lid towards the front of the hose handle.
2. Replace the used batteries with two new ones, type 1.5V AAA. Make sure the polarity of the batteries is placed correct at the bracket.
3. Slide the battery lid back until you hear a click.

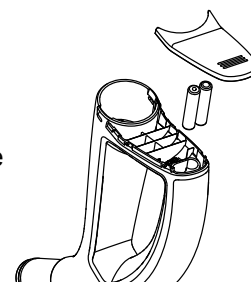

## Parking the tube and nozzle

5

There are two grooves for parking. One located on the underside of the machine to use when machine stands on the back. The other on the back of the machine, to be used when the machine is standing on its wheels.

## Thermal fuse

The machine is fitted with a thermal fuse, which prevents the machine from overheating. If the thermal fuse blows, the machine automatically switches off the motor and must cool before it can be started again.

### Restart

1. Turn off the machine and unplug from the wall socket.
2. Ensure that nothing blocks the air flow through hose handle, hose, tube, nozzle, dust bag or filters.
3. Let the machine cool.
4. Plug in the machine again and push start button. The machine will not start until cool enough. If the machine does not start turn it off and unplug. Try again in a while.



## WARNING

When activating the automatic cable rewind, care must be taken as the plug at the end of the electric cable can swing during the last part of the rewinding. It is recommended that you hold on to the plug while rewinding.

## Cleaning tips

### 6 Crevice nozzle

Use the crevice nozzle for narrow spaces

### 7 Upholstery nozzle

Use the upholstery nozzle for upholstered furniture

### 8 Brush nozzle

Use the brush nozzle for curtains and window sills

### 9 Hard floor nozzle

Use the nozzle for hard floors

### 10 Combination nozzle

Adjust the combination nozzle depending on type of floor

### 11 Turbo nozzle

Use the turbo nozzle for efficient carpet cleaning

### 12 Mini Turbo nozzle

Use the mini turbo nozzle for efficient furniture cleaning

The crevice, upholstery and brush nozzle are located under the accessory lid. The accessory lid is opened by pressing the release button downwards. The lid is closed manually.

The different models of these vacuum cleaners can include different nozzles.

## Trouble-shooting

Repair or service of electrical components as electric cable or motor, must only be carried out by an authorized service center.

If the machine does not start	See to that the plug is correctly fitted to the wall socket.
	A fuse in the building may have blown and needs to be changed.
	The electric cable or plug can be damaged and must be repaired by an authorized service center.
Reduced suction power	The dust bag can be full and needs to be changed, see instructions.
	The pre-filter or the HEPA filter can be blocked and have to be changed, see instructions.
	The hose handle, hose, tube or nozzle can be blocked and needs to be cleaned.
If the machine stops	The thermal fuse may have disengaged, see instructions.

## Service and maintenance

- Store the machine indoors and in a dry environment.
- Change the pre-filter with every fourth dust bag. The dust bag package includes four dust bags and one pre-filter.
- Clean the machine surface with a dry cloth or a damp cloth with a little cleaning agent.
- Order original accessories from a local dealer.
- Service – contact your local dealer.

## Recycling and scrapping

Recycle the wrapping and scrap the machine and electric cable to recommendations from the local authorities. Cut the electric cable as short as possible to avoid that someone gets injured on the scrapped machine.

## Environmental commitment

This machine is designed with the environment in mind. All plastic parts can be used for recycling.

## Responsibility

Nilfisk disclaims all responsibility for all damage caused by incorrect use or modification of the machine.

## Information

For more information see [www.nilfisk.com](http://www.nilfisk.com)

## Guarantee

The guarantee can vary between different countries. Contact your local dealer for information.

## Guarantee and Service

This Nilfisk Select Series vacuum cleaner is covered by a five (5) year guarantee on the machine, which covers the motor, cable re-winder, switch and casing. The nozzles, filters, hoses, tubes and other accessories are covered twelve months due to manufacturing fault only and excludes wear and tear.

The guarantee includes spare parts and labour costs, and covers manufacturing and material defects that may occur during normal domestic use.

Service under the guarantee will only be performed if it can be proven that the defect occurred within the product's guarantee period (a correctly completed guarantee certificate or printed/stamped cash register receipt with date and product type) and on the condition that the vacuum cleaner was bought as a new product and distributed by Nilfisk.

In the event of the repair of defects, the customer must contact Nilfisk to be directed to a service agent at the customer's own expense. Upon completion of any repairs necessary, the vacuum cleaner will be returned to the customer at the risk and expense of Nilfisk.

### The guarantee does not cover:

- Normal wear and tear of accessories and filters.
- Defects or damage occurring as a direct or indirect result of incorrect use - such as the vacuuming of rubble, hot ashes or carpet deodorant powder.
- Abuse, loss or lack of maintenance as described in the Instructions for use.
- Plaster dust.
- Saw dust.
- Water.
- Should not be used for home renovations.

Nor will it cover incorrect or poor configuration, i.e. setting up or connection, nor fire-damage, fire, lightning strike or unusual voltage fluctuations or any other electrical disturbances such as defective fuses or defective electrical installations on the supply grid, and defects or damage in general that Nilfisk consider to be the result of causes other than manufacturing and material defects.

### The guarantee becomes void:

- If a defect is caused by the use of non-original Nilfisk dust bags and filters.
- If the identity number is removed from the vacuum cleaner.
- If the vacuum cleaner has been repaired by a non-Nilfisk authorized dealer.
- If the machine is used in a commercial environment, i.e. building contractors, cleaning contractors, professional trades or any other non-domestic usage.

### The guarantee is valid in:

Great Britain, Ireland, Germany, Belgium, Austria, Switzerland, France, Spain, Portugal, Italy, Holland, Sweden,

Norway, Denmark, Finland, China, Estonia, Latvia, Lithuania, Poland, Slovenia, Hungary, Czech Republic, Slovakia, Greece, Russia, Turkey, Australia and New Zealand.

### Addendum Australia:

Our goods come with guarantees that cannot be excluded under the Australian Consumer Law. You are entitled to a replacement or refund for a major failure and for compensation for any other reasonably foreseeable loss or damage. You are also entitled to have the goods repaired or replaced if the goods fail to be of acceptable quality and the failure does not amount to a major failure.

Nilfisk vacuum cleaners for domestic use are warranted for 2 years from the date of purchase by:

Nilfisk Pty Ltd  
Unit 1/13 Bessemer Street  
Blacktown NSW 2148  
Phone: 1300 556 710  
E-mail: Warranty.au@nilfisk.com

Find your local service agent here: <http://www.nilfisk.com.au>.

The benefits under this warranty are in addition to your national law of sale.

## WEEE



The symbol  on the product or on its packing indicates that this product may not be treated as household waste. Instead it shall be handed over to the applicable collection point for the recycling of electrical and electronic equipment. By ensuring this product is disposed of correctly, you will help prevent potential negative consequences for the environment and human health, which could otherwise be caused by inappropriate waste handling of this product. For more detailed information about recycling of this product, please contact your local city office, your household waste disposal service or the shop where you purchased the product.

## Technical Specifications

		Nilfisk Select	
		EU	UK
Voltage	V	220-230	220-240
Main frequency	Hz	50/60	
Powerconsumption IEC	W	750/800	
Suction power, with hose + tube	W	200	
Air flow rate	l/min.	30	
Vacuum	kPa	20	
Sound pressure level, IEC 60704-2-1	dB (A)	69	
Energy efficiency class	-	A	
Cleaning performance on hard carpet	-	C	
Cleaning performance on hard floor	-	A	
Dust re-emission	-	A	
Annual energy consumption in kWh/annum *)	-	27	
Electric cable, length	m	8	
Insulation class	-	IP20	
Type of protection	-	II	
Dust bag net filling	l	2.7	
Width	mm	300	
Depth	mm	440	
Height	mm	280	
Weight, cleaner only	kg	6.5	
Filter	-	HEPA	

\*) Indicative annual energy consumption (kWh per year), based on 50 cleaning tasks. Actual annual energy consumption will depend on how the appliance is used. Measurements done in accordance with EN 60335-1, EN 60335-2-2 (safety), EN 60312-1 (performance), and EN 60704-1, EN 60704-2 (Noise).

## Declaration of Conformity

We,

Nilfisk A/S  
Kornmarksvej 1  
DK-2605 Broendby  
DENMARK

hereby solely declare that the product:

Brand	Description	Model
Nilfisk	VAC - Consumer - Dry	Select Classic, Select Comfort, Select Superior *

is in compliance with the following standards:

Id and Version	Title
EN 60335-1:2012	Household and similar electrical appliances - Safety - Part 1: General requirements
EN 60335-2-2:2010 + A11:2012+A1:2013	Household and similar electrical appliances - Safety - Part 2-2: Particular requirements for vacuum cleaners and water-suction cleaning appliances
EN 55014-1:2006 +A1:2009+A2:2011	Electromagnetic compatibility - Requirements for household appliances, electric tools and similar apparatus - Part 1: Emission
EN 55014-2:1997 +A1:2001+A2:2008	Electromagnetic compatibility - Requirements for household appliances, electric tools and similar apparatus - Part 2: Immunity - Product family standard
EN 61000-3-2:2006 +A1:2009+A2:2009	Electromagnetic compatibility (EMC) - Part 3-2: Limits - Limits for harmonic current emissions (equipment input current $\leq$ 16 A per phase)
EN 61000-3-3:2013	Electromagnetic compatibility (EMC) - Part 3-3: Limits - Limitation of voltage changes, voltage fluctuations and flicker in public low-voltage supply systems, for equipment with rated current $\leq$ 16 A per phase and not subject to conditional connection
EN 50581:2012	Technical documentation for the assessment of electrical and electronic products with respect to the restriction of hazardous substances
*EN 300 220-2 V2.4.1	ERM; Short range devices; Radio equipment to be used in the 25 MHz to 1000 MHz frequency with power levels ranging up to 500 mW. Part 2: Harmonized EN covering the essential requirements under article 3.2 of the R&TTE Directive
*EN 301 489-1 V1.9.2	EMC standard for radio equipment and services; Part 1: Common technical requirements
*EN 301 489-3 V1.6.1	EMC standard for radio equipment and services; Part 3: Specific conditions for Short-Range Devices (SRD) operating on frequencies between 9 kHz and 246 GHz

Following the provisions of:

Low Voltage Directive 2006/95/EC  
EMC Directive 2004/108/EC  
RoHS Directive 2011/65/EC  
Energy labelling of vacuum cleaners 665/2013/EC  
Ecodesign requirements for standby and off mode 1275/2008/EC  
Ecodesign requirements for vacuum cleaners 666/2013/EC  
\* R&TTE Directive 1999/5/EC

Hadsund 25-11-2015 Anton Sørensen  
Senior Vice President – Global Operations  
R&D – Vacuum Cleaners and High Pressure Washers



Place	Dated	Name and title	Signature
-------	-------	----------------	-----------

1

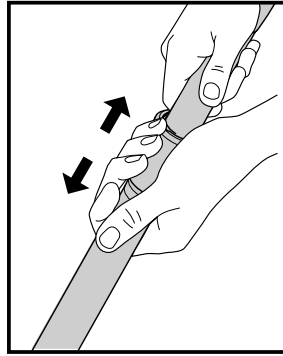
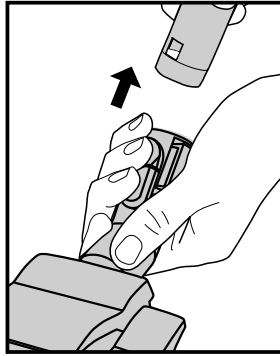
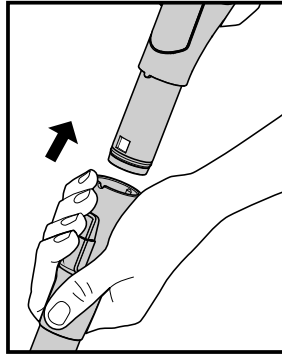
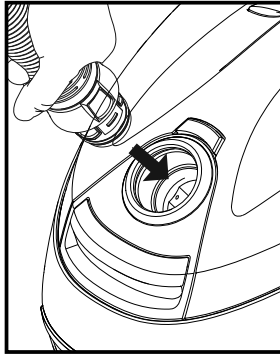

2

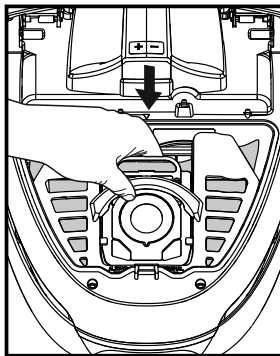
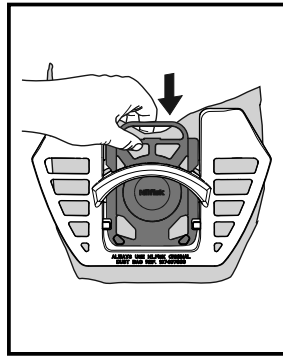
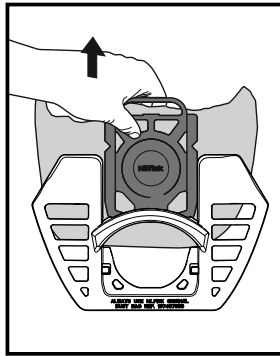
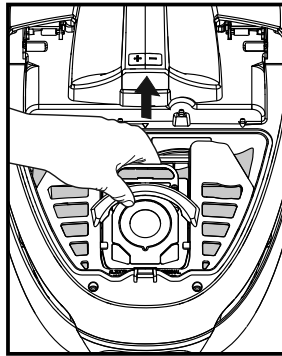
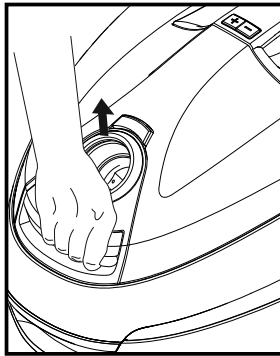

3

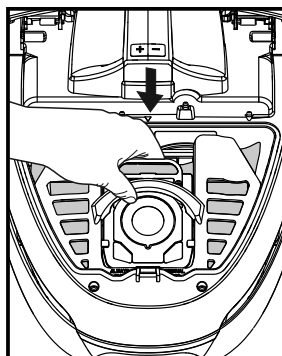
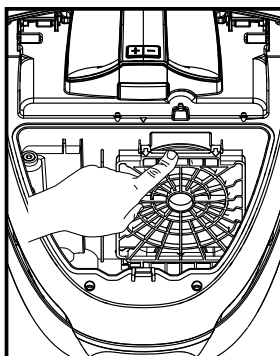
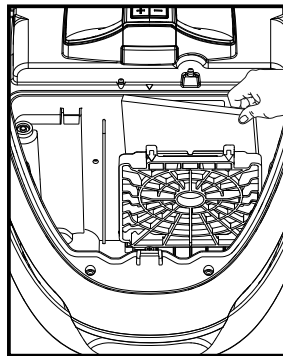
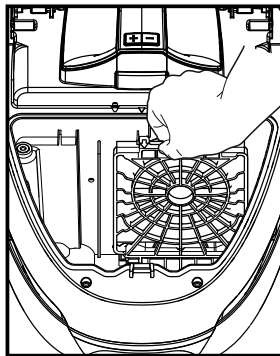
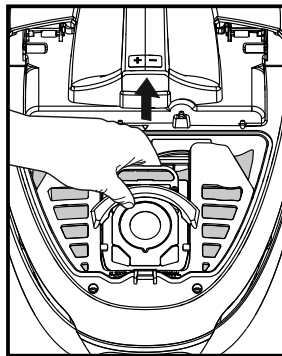
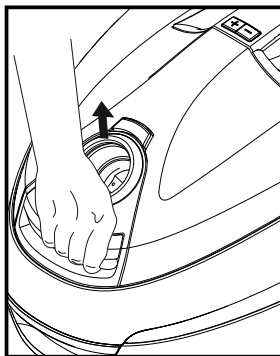

4

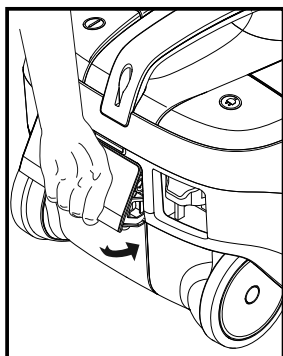
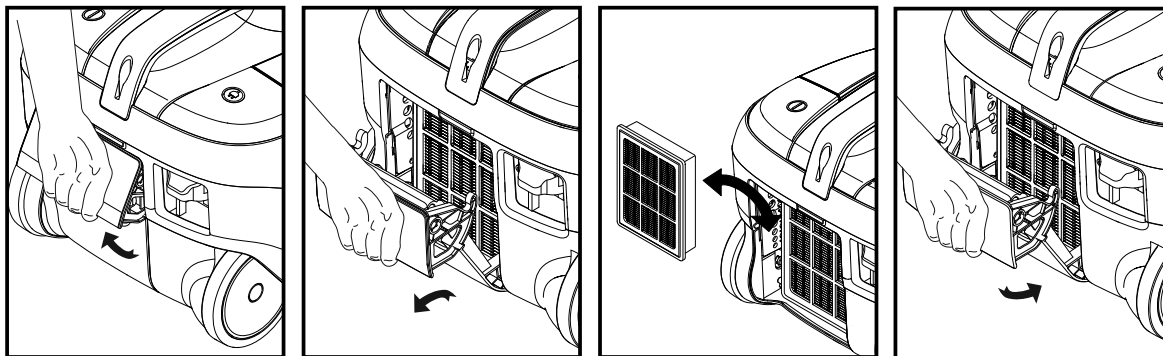

5

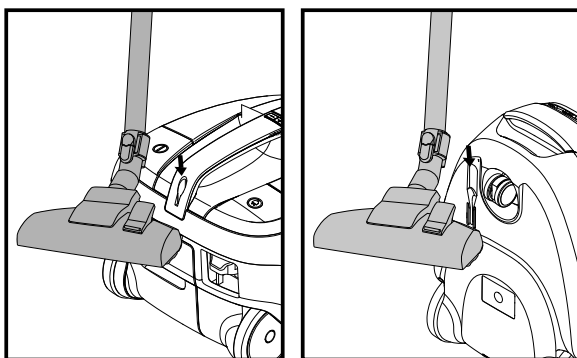

6

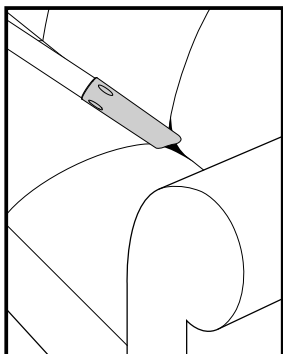

7

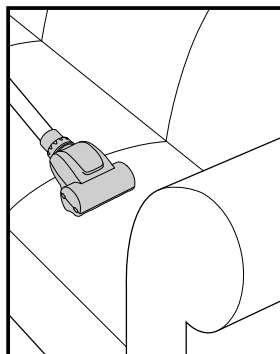
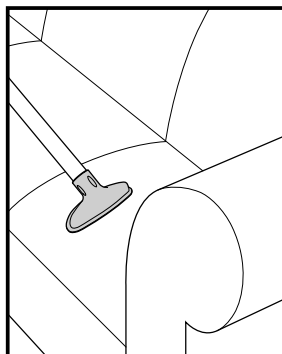

8

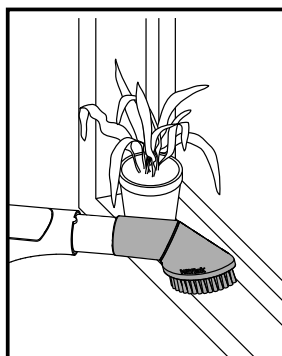
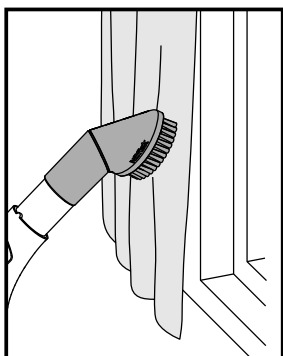

- 9
- 10
- 11

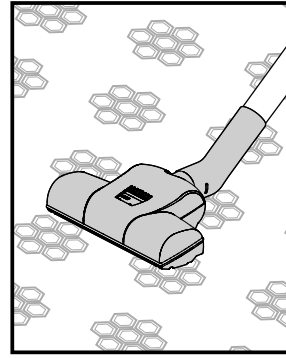
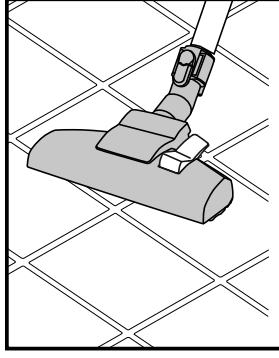
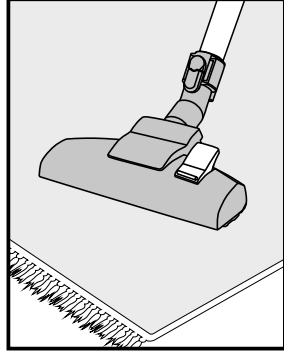
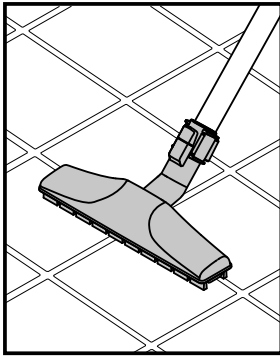



<http://www.nilfisk.com>

## HEAD QUARTER

### DENMARK

Nilfisk A/S  
Kornmarksvej 1  
DK-2605 Broendby  
Tel.: (+45) 4323 8100  
Website: [www.nilfisk.com](http://www.nilfisk.com)

## SALES COMPANIES

### ARGENTINA

Nilfisk srl.  
Edificio Central Park  
Herrera 1855, 6th floor/604  
Ciudad de Buenos Aires  
Tel.: (+54) 11 6091 1571  
Website: [www.nilfisk.com.ar](http://www.nilfisk.com.ar)

### AUSTRALIA

Nilfisk Pty Ltd  
Unit 1/13 Bessemer Street  
Blacktown NSW 2148  
Tel.: (+61) 2 98348100  
Website: [www.nilfisk.com.au](http://www.nilfisk.com.au)

### AUSTRIA

Nilfisk GmbH  
Metzgerstrasse 68  
5101 Bergheim bei Salzburg  
Tel.: (+43) 662 456 400 90  
Website: [www.nilfisk.at](http://www.nilfisk.at)

### BELGIUM

Nilfisk n.v.-s.a.  
Riverside Business Park  
Boulevard Internationalelaan 55  
Bâtiment C3/C4 Gebouw  
Bruxelles 1070  
Tel.: (+32) 14 67 60 50  
Website: [www.nilfisk.be](http://www.nilfisk.be)

### Brazil

Nilfisk do Brasil  
Av. Eng. Luis Carlos Berrini, 550  
40 Andar, Sala 03  
SP - 04571-000 Sao Paulo  
Tel.: (+11) 3959-0300 / 3945-4744  
Website: [www.nilfisk.com.br](http://www.nilfisk.com.br)

### CANADA

Nilfisk Canada Company  
240 Superior Boulevard  
Mississauga, Ontario L5T 2L2  
Tel.: (+1) 800-668-8400  
Website: [www.nilfisk.ca](http://www.nilfisk.ca)

### CHILE

Nilfisk S.A. (Comercial KCS Ltda)  
Salar de Llamara 822  
8320000 Santiago  
Tel.: (+56) 2684 5000  
Website: [www.nilfisk.cl](http://www.nilfisk.cl)

### CHINA

Nilfisk  
4189 Yindu Road  
Xinzhuang Industrial Park  
201108 Shanghai  
Tel.: (+86) 21 3323 2000  
Website: [www.nilfisk.cn](http://www.nilfisk.cn)

### CZECH REPUBLIC

Nilfisk s.r.o.  
VGP Park Horni Počernice  
Do Čertous 1/2658  
193 00 Praha 9  
Tel.: (+420) 244 090 912  
Website: [www.nilfisk.cz](http://www.nilfisk.cz)

### DENMARK

Nilfisk Danmark A/S  
Kornmarksvej 1  
2605 Brøndby  
Tel.: (+45) 4323 4050  
E-mail: [kundeservice.dk@nilfisk.com](mailto:kundeservice.dk@nilfisk.com)

### FINLAND

Nilfisk Oy Ab  
Koskelontie 23 E  
02920 Espoo  
Tel.: (+358) 207 890 600  
Website: [www.nilfisk.fi](http://www.nilfisk.fi)

### FRANCE

Nilfisk SAS  
26 Avenue de la Baltique  
Villebon sur Yvette  
91978 Courtabouef Cedex  
Tel.: (+33) 169 59 87 24  
Website: [www.nilfisk.fr](http://www.nilfisk.fr)

### GERMANY

Nilfisk GmbH  
Guido-Oberdorfer-Straße 2-10  
89287 Bellenberg

Tel.: (+49) (0)7306/72-444  
Website: [www.nilfisk.de](http://www.nilfisk.de)

### GREECE

Nilfisk A.E.  
Αναπαύσεως 29  
Κορωπί Τ.Κ. 194 00  
Tel.: (30) 210 9119 600  
Website: [www.nilfisk.gr](http://www.nilfisk.gr)

### HOLLAND

Nilfisk B.V.  
Versterkerstraat 5  
1322 AN Almere  
Tel.: (+31) 036 5460760  
Website: [www.nilfisk.nl](http://www.nilfisk.nl)

### HONG KONG

Nilfisk Ltd.  
2001 HK Worsted Mills  
Industrial Building  
31-39, Wo Tong Tsui St.  
Kwai Chung, N.T.  
Tel.: (+852) 2427 5951  
Website: [nilfisk.com](http://nilfisk.com)

### HUNGARY

Nilfisk Kft.  
II. Rákóczi Ferenc út 10  
2310 Szigetszentmiklós-Lakihegy  
Tel.: (+36) 24 475 550  
Website: [www.nilfisk.hu](http://www.nilfisk.hu)

### INDIA

Nilfisk India Limited  
Pramukh Plaza, 'B' Wing, 4th floor, Unit No. 403  
Cardinal Gracious Road, Chakala  
Andheri (East) Mumbai 400 099  
Tel.: (+91) 22 6118 8188  
Website: [www.nilfisk.in](http://www.nilfisk.in)

### IRELAND

Nilfisk  
1 Stokes Place  
St. Stephen's Green  
Dublin 2  
Tel.: (+35) 3 12 94 38 38  
Website: [www.nilfisk.ie](http://www.nilfisk.ie)

### ITALY

Nilfisk SpA  
Strada Comunale della Braglia, 18  
26862 Guardamiglio (LO)  
Tel.: (+39) (0) 377 414021  
Website: [www.nilfisk.it](http://www.nilfisk.it)

### JAPAN

Nilfisk Inc.  
1-6-6 Kita-shinyokohama, Kouhoku-ku  
Yokohama, 223-0059  
Tel.: (+81) 45548 2571  
Website: [www.nilfisk.com](http://www.nilfisk.com)

### MALAYSIA

Nilfisk Sdn Bhd  
Sd 33, Jalan KIP 10  
Taman Perindustrian KIP  
Sri Damansara  
52200 Kuala Lumpur  
Tel.: (60) 3603 627 43 120  
Website: [www.nilfisk.com](http://www.nilfisk.com)

### MEXICO

Nilfisk de Mexico, S. de R.L. de C.V.  
Pirineos #515 Int.  
60-70 Microparque  
Industrial WSantiago  
76120 Queretaro  
Tel.: (+52) (442) 427 77 00  
Website: [www.nilfisk.com](http://www.nilfisk.com)

### NEW ZEALAND

Nilfisk Limited  
Suite F, Building E  
42 Tawa Drive  
0632 Albany Auckland  
Tel.: (+64) 9 414 1996  
Website: [www.nilfisk.com](http://www.nilfisk.com)

### NORWAY

Nilfisk AS  
Bjørnerudveien 24  
1266 Oslo  
Tel.: (+47) 22 75 17 80  
Website: [www.nilfisk.no](http://www.nilfisk.no)

### PERU

Nilfisk S.A.C.  
Calle Boulevard 162, Of. 703, Lima 33- Perú  
Lima  
Tel.: (511) 435-6840  
Website: [www.nilfisk.com](http://www.nilfisk.com)

### POLAND

Nilfisk Sp. Z.O.O.  
Millenium Logistic Park  
ul. 3 Maja 8, Bud. B4  
05-800 Pruszków  
Tel.: (+48) 22 738 3750  
Website: [www.nilfisk.pl](http://www.nilfisk.pl)

### PORTUGAL

Nilfisk Lda.  
Sintra Business Park  
Zona Industrial Da Abrunheira  
Edifício 1, 1º A

P2710-089 Sintra  
Tel.: (+351) 21 911 2670  
Website: [www.nilfisk.pt](http://www.nilfisk.pt)

### RUSSIA

Nilfisk LLC  
Vyatskaya str. 27, bld. 7/1st  
127015 Moscow  
Tel.: (+7) 495 783 9602  
Website: [www.nilfisk.ru](http://www.nilfisk.ru)

### SINGAPORE

Den-Sin  
22 Tuas Avenue 2  
639453 Singapore  
Tel.: (+65) 6268 1006  
Website: [www.densin.com](http://www.densin.com)

### SLOVAKIA

Nilfisk s.r.o.  
Bancíkovej 1/A  
SK-821 03 Bratislava  
Tel.: (+421) 910 222 928  
Website: [www.nilfisk.sk](http://www.nilfisk.sk)

### SOUTH AFRICA

WAP South Africa  
12 Newton Street  
Spartan 1630  
Tel.: (+27) 11 975 7060  
Website: [www.wap.com.za](http://www.wap.com.za)

### SOUTH KOREA

Nilfisk Korea  
3F Duksoo B/D, 317-15  
Sungsoo-Dong 2Ga  
Sungdong-Gu, Seoul  
Tel.: (+82) 2497 8636  
Website: [www.nilfisk.co.kr](http://www.nilfisk.co.kr)

### SPAIN

Nilfisk S.A.  
Torre d'Ara,  
Passeig del Rengle, 5 Plta. 10ª  
08302 Mataró  
Tel.: (34) 93 741 2400  
Website: [www.nilfisk.es](http://www.nilfisk.es)

### SWEDEN

Nilfisk AB  
Taljegårdsgatan 4  
431 53 Möndal  
Tel.: (+46) 31 706 73 00  
Website: [www.nilfisk.se](http://www.nilfisk.se)

### SWITZERLAND

Nilfisk AG  
Ringstrasse 19  
Kircheberg/Industri Stelz  
9500 Wil  
Tel.: (+41) 71 92 38 444  
Website: [www.nilfisk.ch](http://www.nilfisk.ch)

### TAIWAN

Nilfisk Ltd  
Taiwan Branch (H.K)  
No. 5, Wan Fang Road  
Taipei  
Tel.: (+88) 6227 00 22 68  
Website: [www.nilfisk.tw](http://www.nilfisk.tw)

### THAILAND

Nilfisk Co. Ltd.  
89 Soi Chokechai-Ruammitr  
Viphavadee-Rangsit Road  
Ladyao, Jatuchak, Bangkok 10900  
Tel.: (+66) 2275 5630  
Website: [www.nilfisk.co.th](http://www.nilfisk.co.th)

### TURKEY

Nilfisk A.S.  
Serifali Mh. Bayraktar Bulv. Sehit Sk. No:7  
Umraniye, 34775 Istanbul  
Tel.: +90 216 466 94 94  
Website: [www.nilfisk.com.tr](http://www.nilfisk.com.tr)

### UNITED ARAB EMIRATES

Nilfisk Middle East Branch  
SAIF-Zone  
P.O. Box 122298  
Sharjah  
Tel.: (+971) (0) 655-78813  
Website: [www.nilfisk.com](http://www.nilfisk.com)

### UNITED KINGDOM

Nilfisk Ltd.  
Nilfisk House, Bowerbank Way  
Gilwilly Industrial Estate, Penrith  
Cumbria CA11 9BQ  
Tel.: (+44) (0) 1768 868995  
Website: [www.nilfisk.co.uk](http://www.nilfisk.co.uk)

### UNITED STATES

Nilfisk Inc.  
14600 21st Avenue North  
Plymouth, MN-55447  
Tel.: (+1) 800-989-2235  
Website: [www.nilfisk.com](http://www.nilfisk.com)

### VIETNAM

Nilfisk Vietnam  
No. 51 Doc Ngu Str.  
P. Vinh Phuc, Q.Ba Dinh  
Hanoi  
Tel.: (+84) 761 5642  
Website: [www.nilfisk.com](http://www.nilfisk.com)