

DEHAN TOOLS

INSTRUCTION MANUAL



MODEL DSC-0689

21V12"MINI BRUSHLESS CHAIN SAW

If you have questions or comments, contact us at
dehantools@afterservice.vip

CALL: +1(877)422 4607(US Toll-free)

EXTENDED WARRANTY REGISTRATION

Dear Customer,

Thank you very much for choosing DEHANTOOLS. At DEHANTOOLS, customer satisfaction is our highest priority. In order to provide the best services.

Please send your name, your email AND your Amazon order number to dehantools@afterservice.vip or scan our after-sales QR code. Our customer services representative will help you register within 24 hours.

Disclaimer: This policy is at the manufacturer's discretion.

Best Regards,
DEHANTOOLS Customer Support



dehantools@afterservice.vip

Table of Content

| | |
|--|-----------|
| GENERAL SAFETY RULES | 1 |
| ADDITIONAL SAFETY RULES FOR HEDGE TRIMMER | 7 |
| IMPORTANT SAFETY FOR ALL BATTERY PACKS | 8 |
| SPECIFIC SAFETY FOR LITHIUM-ION | 10 |
| IMPORTANT SAFETY FOR ALL BATTERY CHARGERS | 10 |
| COMPONENTS AND SPECIFICATIONS | 13 |
| SPECIFIC INSTRUCTIONS | 14 |
| • Battery Installation | 14 |
| • Assembly of Guide Bar and Saw Chain | 15 |
| • Chain Tensioning | 17 |
| • Lubrication of the Chain | 18 |
| • Chain Saw Operation | 19 |
| • Charging Procedure | 20 |
| TROUBLESHOOTING | 22 |
| OPERATION & MAINTENANCE | 23 |
| WARRANTY | 26 |

dehantools@afterservice.vip

SAVE THIS INSTRUCTIONAL MANUAL FOR FUTURE REFERENCE.

Definitions: Safety Guidelines

The definitions below describe the level of severity for each signal word. Please read the manual and pay attention to these symbols.

WARNING: Indicates a potentially hazardous situation which, if not avoided, **could** result in **death or serious injury**.

CAUTION: Indicates a potentially hazardous situation which, if not avoided, **may** result in **minor or moderate injury**.

NOTE: Indicates a practice not related to personal injury which, if not avoided, **may** result in **property damage**.



WARNING! Read and understand all instructions. Failure to follow all instructions listed below may result in electric shock, fire and/or serious personal injury.

GENERAL SAFETY RULES

WORK AREA SAFETY

- **Keep your work area clean and well lit.** Cluttered benches and dark areas invite accidents.
- **Do not operate power tools in explosive atmospheres, such as in the presence of flammable liquids, gases, or dust.** Power tools create sparks which may ignite the dust or fumes.

WARRANTY

Every DEHANTOOLS power tool is warranted to the original purchaser only to be free from defects in material and workmanship. Subject to certain exceptions, DEHANTOOLS will replace any part on an electric power tool that is defective in material or workmanship for a period of 1 year after the date of purchase unless otherwise noted. This warranty does not apply to damage from repairs made or attempted by anyone other than DEHANTOOLS, misuse, alterations, abuse, normal wear and tear, lack of maintenance, or accidents.

Normal Wear: Many power tools need periodic parts replacement and service to achieve best performance. This warranty does not cover repair when normal use has exhausted the life of a part including, but not limited to, chucks, brushes, cords, saw shoes, blade clamps, o-rings, seals and driver blades.

Warranty Registration is not necessary to obtain the applicable warranty on a DEHANTOOLS power tool product.

This warranty applies to product sold in the U.S.A. only.

REPLACING THE SAW CHAIN AND GUIDE BAR

The guide bar must be replaced if the groove of the guide is worn out or the spur wheel in the guide bar is damaged or worn out.

CHECKING THE AUTOMATIC CHAIN LUBRICATION

Regularly check the functionality of the automatic chain lubrication in order to prevent overheating and the subsequent damage to the guide bar and saw chain associated with it. For this purpose, align the guide bar tip against a smooth surface (board, cut-in of a tree) and allow the chain saw to run. If an increasing amount of oil appears, the automatic chain lubrication functions properly.

- **Keep bystanders, children, and visitors away while operating a power tool.** Distractions can cause you to lose control.
- **Know your product.** Know how to start and stop the machine. Be thoroughly familiar with the controls.
- **Keep proper footing and balance at all times.** Proper footing and balance enable better control of the tool in unexpected situation.
- **Avoid accidental starting.** Do not carry the garden cultivator with your finger on the switch. Make sure the switch is off before taking off the battery.
- Keep all nuts, bolts and screws tight to be sure the equipment is in safe working condition.

ELECTRICAL SAFETY

- **Do not expose power tools to rain or wet conditions.** Water entering a power tool will increase the risk of electric shock.
- **The chargers power plug must match the outlet.** Never modify the plug or plug the tool into outlets that do not match the plug.
- **Avoid to contact with grounded elements such as metal tables, pipes, ranges or refrigerators.** Contact with these elements can put you at a risk of electrical shock.
- **Always inspect electrical cord for damage before and after use.** A damaged cord can cause electrical shock.
- **If the user must use the tool in damp conditions, use a ground fault circuit interrupter (GFCI).**



PERSONAL SAFETY

- **Stay alert, watch what you are doing and use common sense when operating a power tool.** Do not use tool while tired or under the influence of drugs, alcohol, or medication. A moment of inattention while operating power tools may result in serious personal injury.
- **Dress properly. Do not wear loose clothing or jewelry. Contain long hair. Keep your hair, clothing, and gloves away from moving parts.** Loose clothing, jewelry, or long hair can be caught in moving parts. Air vents often cover moving parts and should also be avoided.
- **Use personal protective equipment. Always wear eye protection.** Protective equipment such as dust mask, non-skid safety shoes, hard hat, or hearing protection used for appropriate conditions will reduce personal injuries.
- **Avoid accidental starting. Be sure switch is off before plugging in.** Carrying tools with your finger on the switch or plugging in tools that have the switch on invites accidents.
- **Do not overreach. Keep proper footing and balance at all times.** Proper footing and balance enable better control of the tool in unexpected situations.
- **If devices are provided for the connection of dust extraction and collection facilities, ensure these are connected and properly used.** Use of dust collection can reduce dust-related hazards.
- **Avoid prolonged use.** The tool's repetitive motion and vibration can cause harm to your hands or arms. The user can use gloves for extra cushion; take frequent breaks and limits daily use to prevent this issue.

2. A kickback generates an abrupt powerful force. The saw usually reacts in an uncontrolled manner, creating the possibility of injury to the user.
3. The danger of a kickback is greatest when attempting to cut near or with the guide bar tip. Always apply the saw as flatly as possible in order avoid a loss of control during operation.



WARNING! Do not cut down trees in high wind conditions. This can result in injury and should only be performed by a trained professional.

CLEANING

1. Regularly clean the tensioning mechanisms by blowing compressed air onto it or by cleaning it with a brush. Do not use any tools for the cleaning.
2. Keep the oil away from the handle in order to ensure a secure hold.
3. Clean the machine as necessary with a damp cloth and a mild cleanser, if appropriate.
4. If the chain saw is not used for an extended period of time, remove the chain oil from the tank. Briefly place the chain and the guide bar in an oil bath and then wrap in oil paper to dry.
5. Always replace the protective cover for transport or storage of the chain saw. Secure the tool during transport to avoid damage or injuries. Unplug the power supply before cleaning. Never immerse the machine in water or other liquids. Store the chain saw in a safe and dry area away from children.

OPERATION & MAINTENANCE

SAWING TECHNIQUES

1. Saw off the lower branches on the tree first. By doing so, it is easier for the cut branches to fall to the ground.
2. At the end of the cut, the weight of the saw suddenly increases for the user since it is no longer being supported by a branch. There is a risk of losing control of the saw, so make sure to stay alert during the entire sawing operation.
3. Only pull the saw out of a cut while the saw is running. By doing so, you prevent the chain from jamming in the wood.
4. Do not saw with the tip of the guide bar. Do not saw into the branch formations (where the tree branches outwards). This will impede the tree's ability to heal.
5. For sawing off smaller branches, place the stop face of the saw on the branch. This prevents unwanted movements of the saw at the beginning of the cut. While applying light pressure, guide the saw through the branch from top to bottom.
6. For sawing off larger branches, first make a relief cut. Saw through 1/3 of the branch diameter from the bottom to top using the top side of the guide bar. Then saw from top to bottom for the other 2/3 using the bottom side of the guide bar. Saw off longer branches in sections in order to maintain control over the location of impact.

PREVENTING KICKBACK

1. The term kickback refers to when the saw suddenly jumps up and back. This is usually caused by the workpiece coming into contact with the guide bar tip or the clamping of the saw chain.

- **Never place hands or any other body parts in the fastener discharge area of the tool.** The tool might eject a fastener and could result in death or serious personal injury.
- **For overhead work, wear safety helmet.**

POWER TOOL USE AND CARE

- **Use only accessories that are recommended by the manufacturer for your model.** Accessories that may be suitable for one tool may become hazardous when used on another tool.
- **Maintain the tool with care.** Keep the cutting edge sharp and clean for optimal performance and to reduce the risk of injury. Keep the handles dry, clean and free from oil and grease. Follow the accidental recommendations described in the maintenance section of this manual.
- **Avoid dangerous environments.** Do not use the tool in rain, damp or wet locations. Do not operate the tool in gaseous or explosive atmospheres or use the tool near flammable or combustible liquids. Motors in these tools normally spark, and the sparks might ignite fumes.
- **Practice safe working practices and ensure all relevant legal requirements are being followed when using this tool.**
- **Never point the tool at the user or others in the work area.** This could cause serious injury.
- **Do not force tool. Use the correct tool for your application.** The correct tool will do the job better and safer at the rate for which it is designed.
- **Do not use tool if switch does not turn it on or off.** Any tool that cannot be controlled with the switch is dangerous and must be repaired.

- **Store idle tools out of reach of children and other untrained persons.** Tools are dangerous in the hands of untrained users.
- **Before making adjustments, changing accessories, or storing the tool, please disconnect the tool from the battery.** This will reduce the risk of injury from the power tool.
- **Check operation of the tool before use.** Do not use the tool if the workpiece contact mechanism is not working correctly as accidental driving of a fastener may occur.
- **Do not use the tool if the trigger does not actuate properly.** Any tool that cannot be controlled with the trigger is dangerous and must be repaired.
- **Do not drop or throw this tool. Dropping or throwing the tool can result in damage that will make the tool unusable or unsafe.** If the tool has been dripped or thrown, examine the tool closely for bent, cracked or broken parts. STOP and repair before using or serious injury could occur.

BATTERY USE AND CARE

- **Only use batteries that are recommended for this tool by the manufacturer.** Use any other battery may cause risk of injury or fire.
- **Recharge only with the charger specified by the manufacturer.** A charger that is suitable for one type of battery pack may create a risk of fire when used with another battery pack.
- **Use power tools only with specifically designated battery packs.** Use of any other battery packs may create a risk of injury and fire.

TROUBLE SHOOTING

| Problems | Probable Causes | Solutions |
|-------------------------------|---|--|
| Unit will not operate. | <ul style="list-style-type: none"> • Battery pack not installed correctly. • Battery pack not charged. • Lock-off Button not pressed | <ul style="list-style-type: none"> • Check battery pack installation. • Check battery pack charging requirements. • Press the lock-off button before pulling the trigger. |
| Overheating Chain/Bar | <ul style="list-style-type: none"> • Chain too tight • Lubrication needed | <ul style="list-style-type: none"> • Adjust the chain tension. • Check the oil tank level and add oil as necessary. |
| Loose Chain | <ul style="list-style-type: none"> • Chain tension set incorrectly | <ul style="list-style-type: none"> • Adjust the chain tension. |
| Poor Cut Quality | <ul style="list-style-type: none"> • Chain tension set incorrectly • Chain needs to be cleaned. • Chain needs to be sharpened. • Chain needs replacement. | <ul style="list-style-type: none"> • Adjust the chain tension. • Put off the chain and clean. • Either sharpen or replace the chain. • Replace the chain. |
| Unit runs but does not cut. | <ul style="list-style-type: none"> • Chain installed backwards. | <ul style="list-style-type: none"> • Install the chain with the blades facing the correct direction. |
| Battery pack will not charge. | <ul style="list-style-type: none"> • Battery pack not inserted into the charger properly. • Charger not plugged in. • Surrounding air temperature too hot or too cold. | <ul style="list-style-type: none"> • Insert battery pack into charger and check red LED appears. • Plug charger into a working outlet • Move charger and battery pack to a surrounding air temperature of above 40°F or below 105°F |
| Unit shuts off abruptly. | <ul style="list-style-type: none"> • Battery pack had reached its maximum thermal limit. • Out of charge. | <ul style="list-style-type: none"> • Allow the battery pack to cool down. • Place on charger and allow to charge. |
| Intermittent operation | | |



Charger Indicator:

| Red Indicator | Green Indicator | Battery Pack | Status |
|---------------|-----------------|-----------------|-----------------|
| ON | OFF | Charging | Charging |
| OFF | ON | Charged | Charged |
| OFF | OFF | Short Circuited | Short Circuited |

**IMPORTANT SAFETY INSTRUCTIONS FOR BATTERY CARTRIDGE**

- 1. If operating time has become excessively shorter, stop operating immediately. It may result in a risk of overheating, possible burns and even an explosion.**
- 2. Do not short the battery cartridge:**
 - (1) Do not touch the terminals with any conductive material.
 - (2) Avoid storing battery cartridge in a container with other metal objects such as nails, coins, etc.
 - (3) Do not expose battery cartridge to water or rain.

A battery short can cause a large current flow, overheating, possible burns and even a breakdown.
- 3. Do not incinerate the battery cartridge even if it is severely damaged or is completely worn out. The battery cartridge can explode in a fire.**
- 4. Be careful not to drop or strike battery.**
- 5. Follow your local regulations relating to disposal of battery.**

- **When battery pack is not in use, keep it away from other metal objects like paper clips, coins, keys, nails, screws, or other small metal objects that can make a connection from one terminal to another.** Shorting the battery terminals together may cause burns or a fire.
- **Under abusive conditions, liquid may be ejected from the battery; avoid contact. If contact accidentally occurs, flush with water. If liquid contacts eyes, additionally seek medical help.** Liquid ejected from the battery may cause irritation or burns.
- **Do not use a battery pack or tool that is damaged or modified.** Damaged or modified batteries may exhibit unpredictable behavior resulting in fire, explosion or risk of injury.
- **Do not expose a battery pack or tool to fire or excessive temperature.** Exposure to fire or temperature above 265°F (130°C) may cause explosion.
- **Follow all charging instructions and do not charge the battery pack or tool outside the temperature range specified in the instructions.** Charging improperly or at temperatures outside the specified range may damage the battery and increase the risk of fire.
- **Before cleaning the charger, make sure to unplug it from any power source.** This will reduce the risk of an electrical shock.

TOOL SERVICE

- **Recharge only with the charger specified by the manufacturer.** A charger that is suitable for one type of battery pack may create a risk of fire when used with another battery pack.
- **Never service damaged battery packs.** Service of battery packs should only be performed by the manufacturer or authorized service providers.
- **Tool service must only be performed by a qualified repair personnel.**

ADDITIONAL SAFETY RULES FOR OPERATION

- **Do not use the unit if switch does not turn it on or off.** A unit that cannot be controlled with the switch is dangerous and must be repaired.
- **Do not carry the tool for place to place while holding the trigger.** Accidental discharge could result.
- **Before beginning work, inspect the chain saw for damage to the housing, the extension cord, the saw chain and the guide bar.** Never use an obviously damaged machine.
- **Check the fill level of the oil tank. Also check whether there is sufficient oil available while working.**
- **Never operate the saw if there is no oil or the oil level has dropped below the minimum oil level mark in order to prevent damage to the chain saw.** On average, an oil filling is sufficient for approximately 10 minutes of cutting operation (depending the duration of pauses and the density of the workpiece).
- **Check the tension of the saw and the condition of the blades.** The sharper the saw chain is, the easier and more manageable operations will be. The same applies to chain tension. Check the tension every 10 minutes of operation to maximize safety. New saw chains in particular are subject to changes due to the heat created by operation.
- **Keep hands away from rotating parts.**
- **Always handle the tool with care:**
 1. Respect the tool as a working implement;
 2. Never engage in horseplay;
 3. Keep others at a safe distance from the tool while tool is in operation as accidental actuation may occur, possibly causing injury.

Charging Procedure

DEHANTOOLS chargers are designed to charge DEHANTOOLS battery packs in 60~90 minutes depending on the pack being charged.

To charge the battery:

1. Insert/Slide the battery pack into the charger as shown as below.

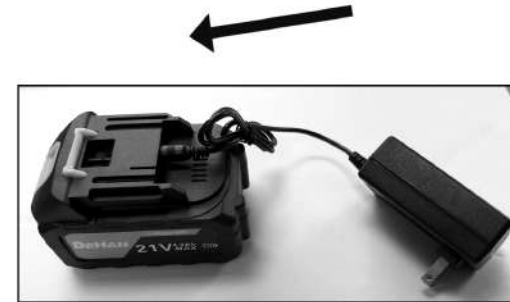

2. Plug the charger into an appropriate outlet after inserting the battery pack.

Recharge discharged batteries as soon as possible after use or battery life may be greatly diminished. for longest battery life, do not discharge batteries fully. It is recommended that the batteries be recharged after each use.

NOTE: Battery packs for this tool are shipped in a low charge condition to prevent possible problems.

NOTE: A battery that is new or has not been used for a longer period does not develop its full capacity until after approx. 5 charge/discharge cycles.

Chain Saw Operation

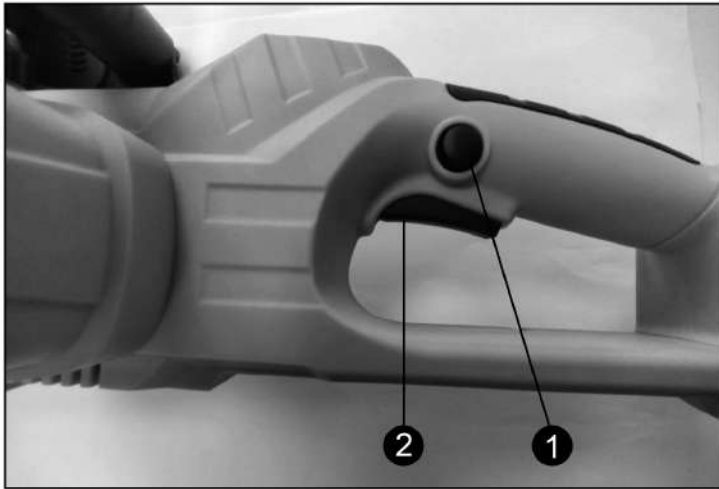

To turn the tool **ON**: Press the lock-off button(①) and the squeeze the switch trigger(②). After the tool has started, you can release the lock-off button without turning the tool off.

To turn the tool **OFF**: Release the Switch Trigger(②).



WARNING! Release switch trigger, allow chainsaw to come to a complete stop, and then remove battery.



WARNING! If any parts are missing, do not operate this tool until the missing parts are replaced. Failure to do so may result in serious personal injury. Please contact us for the missing parts.

IMPORTANT SAFETY FOR ALL BATTERY PACKS

The battery pack is not fully charged out of the carton. Before using the battery pack and charger, read the safety instructions below and then follow charging procedures outlined.

- **Do not charge or use the battery pack in explosive atmospheres, such as in the presence of flammable liquids, gases or dust.** Inserting or removing the battery pack from the charger may ignite the dust or fumes.
- **NEVER force the battery pack into the charger. Do not modify the battery pack in any way to fit into a non-compatible charger as battery pack may rupture causing serious personal injury.**
- Charge the battery packs only in designated DEHANTOOLS chargers.
- **DO NOT splash or immerse in water or other liquids.**
- **Do not store or use the tool and battery pack in locations where the temperature may reach or exceed 104 °F (40 °C) (such as outside sheds or metal buildings in summer).** For best life store battery packs in a cool, dry location.

NOTE: Do not store the battery packs in a tool with the trigger switch locked on. Never tape the trigger switch in the ON position.



WARNING! Fire hazard. Never attempt to open the battery pack for any reason. If the battery pack case is cracked or damaged, do not insert into the charger. Do not crush, drop or damage the battery pack. Do not use a battery pack or charger that has received a sharp blow, been dropped, run over or damaged in any way (e.g., pierced with a nail, hit with a hammer, stepped on). Damaged battery packs should be returned to the service center for recycling.



WARNING! Shock hazard. Do not allow any liquid to get inside the charger. Electric shock may result.



WARNING! Burn hazard. To reduce the risk of injury, charge only DEHAN rechargeable battery packs. Other types of batteries may overheat and burst resulting in personal injury and property damage.

NOTE: Under certain conditions, with the charger plugged into the power supply, the charger can be shorted by foreign material. Foreign materials of a conductive nature, such as, but not limited to, grinding dust, metal chips, steel wool, aluminum foil or any buildup of metallic particles should be kept away from the charger cavities. Always unplug the charger from the power supply when there is no battery pack in the cavity. Unplug the charger before attempting to clean.

4. Once the chain is properly tensioned, tighten the bar adjustment locking knob. Do not over-tension the chain: this will lead to excessive wear and reduces the life of both the bar and chain.

NOTE: The saw chain must be tensioned properly in order to ensure safe operation. The chain tension is optimal if the saw chain can be lifted 1/8 inch (3 mm) from the center of the guide bar. Since the saw chain heats up during operation, its length can therefore fluctuate. Check the chain tension every 10 minutes of operation and adjust as necessary, particularly for new saw chains. Slacken the saw chain after the work is completed since it shortens when cooling down. In doing so, you can elongate the chain's life and prevent damage.

Lubrication of the chain

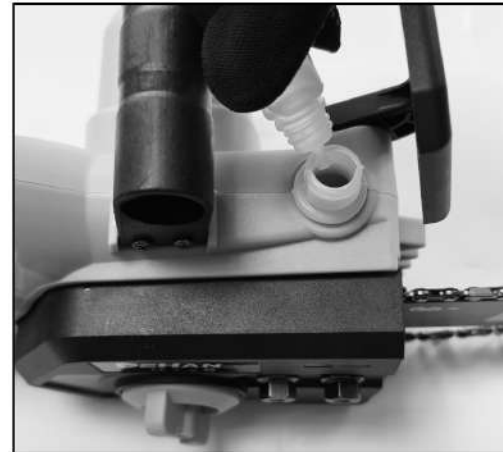

- a. Find the oil pot with oil bubbles on the machine and open the lid of the oil pot.
- b. Open the oil pot provide in the. accessory and pour the oil into the pot. Finally, tighten the lif to prevent the oil from leaking out.



WARNING! Sharp moving chain. To prevent accidental operation, ensure that battery is removed from the tool before performing the operations above. Failure to do this could result in serious personal injury.

Chain Tensioning

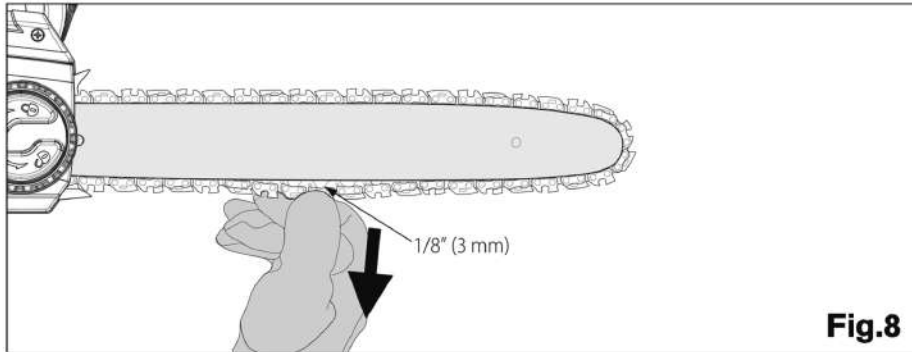
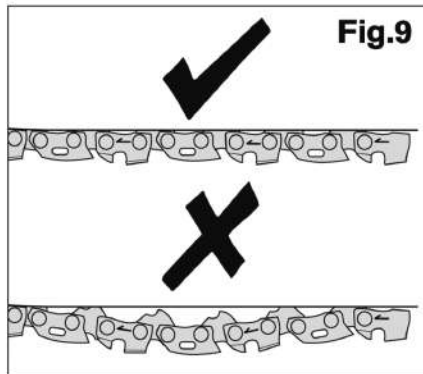

Fig.8

1. Check the chain tension by pulling the saw away from the guide bar. A properly tensioned chain should have roughly 1/8 inch of distance between itself and bar guide.(Fig.8)
2. If adjustments are needed, loosen the bar adjustment locking knob one full turn.

3. To adjust the saw chain tension, rotate the chain tensioning wheel. Rotating the wheel upwards increases the tension while rotating it downwards decreases tension. A properly tensioned chain should have no sag and should only be able to be pulled 1/8 inch (3 mm) away from the guide bar of the saw.(Fig.9)



SPECIFIC SAFETY FOR LITHIUM-ION

- **Do not incinerate the battery pack even if it is severely damaged or is completely worn out.** The battery pack can explode in a fire. Toxic fumes and materials are created when lithium ion battery packs are burned.
- **If battery contents come into contact with the skin, immediately wash area with mild soap and water.** If battery liquid gets into the eye, rinse water over the open eye for 15 minutes or until irritation ceases. If medical attention is needed, the battery electrolyte is composed of a mixture of liquid organic carbonates and lithium salts.
- **Contents of opened battery cells may cause respiratory irritation.** Provide fresh air. If symptoms persist, seek medical attention.



WARNING! Burn hazard. Battery liquid may be flammable if exposed to spark or flame.

IMPORTANT SAFETY FOR ALL BATTERY CHARGERS

- **DO not attempt to charge the battery pack with any chargers other than the ones in this manual.** The charger and battery pack are specifically designed to work together.
- **These chargers are not intended for any uses other than charging DEHAN rechargeable batteries.** Any other uses may result in risk of fire, electric shock or electrocution.

- **Do not expose the charger to rain or snow.**
- **Pull by the plug rather than the cord when disconnecting the charger.** This will reduce the risk of damage to the electric plug and cord.
- **Make sure that the cord is located so that it will not be stepped on, tripped over or otherwise subjected to damage or stress.**
- **Do not use an extension cord unless it is absolutely necessary.** Use of improper extension cord could result in risk of fire, electric shock or electrocution.
- **When operating a charger outdoors, always provide a dry location and use an extension cord suitable for outdoor use.** Use of a cord suitable for outdoor use reduces the risk of electric shock.
- **Do not place any object on top of the charger or place the charger on a soft surface that might block the ventilation slots and result in excessive internal heat.** Place the charger in a position away from any heat source. The charger is ventilated through slots in the top and the bottom of the housing.
- **Do not operate the charger with a damaged cord or plug.**
- **Do not operate the charger if it has received a sharp blow, been dropped or otherwise damaged in any way.** Contact us immediately.
- **Do not disassemble the charger; take it to an authorized service center when service or repair is required.** Incorrect reassembly may result in a risk of electric shock, electrocution or fire.
- **Disconnect the charger from the outlet before attempting any cleaning.** This will reduce the risk of electric shock. Removing the battery pack will not reduce this risk.
- **NEVER** attempt to connect 2 chargers together.



Fig.6

Fig.7

- a. Place the saw body on a firm and level surface.
- b. Rotate the Cover Knob(10) and two Fixed Nut(12) counterclockwise to remove the Side Cover (11) from the saw's body.(Fig.2)
- c. Please check the direction of the Saw Chain(8) on the Guide Plate (9) first(Fig.3). And then with the help of protective gloves, wrap the saw chain around the Guide Plate(9), making sure that the teeth are facing the correct direction. The chain should be properly set in the slot running along the entire outside edge of the Guide Plate(9). (Fig.4)
- d. Place the Saw Chain(8) around the sprocket while lining up the slot on the Guide Plate(9) with the bolt in the base of the tool. (Fig.5)The chain tensioning knob need to align with the bolt. Use the Cover Knob(10) to adjust its location until it fits in the Guide Plate(9).
- e. Use the screwdriver to screw the bolt and tight the Guard.(Fig.6)
- f. Turn the Cover Knob(10) and two Fixed Nut(12) to tighten the Guide Plate(9) enough that it stays in place. While holding the plate still, place the Side Cover (11) back onto the saw. Make sure the tab properly lines up with the slot on the body of the saw. Lock the cover with the Cover Knob(11) by turning it clockwise until it engages.(Fig.7)

1. **To install battery pack:** Insert battery pack (①) into tool, until an audible click is heard. (Fig.1)

1. **To remove battery pack from tool:** Release the battery release button (②) and pull battery pack out of tool.

NOTE: Always release the ON/OFF Button before insertion or removal of the battery pack.

Assembly of Guide Bar and Saw Chain



Fig.2



Fig.3

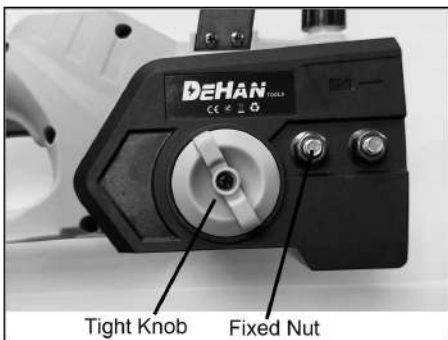

Fig.4

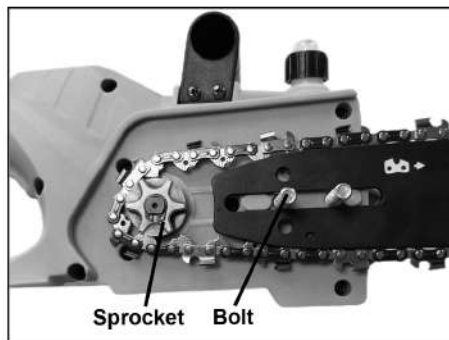

Fig.5

- **The charger is designed to operate on standard 120V household electrical power. Do not attempt to use it on any other voltage.** This does not apply to the vehicular charger.



WARNING! Shock hazard. Do not allow any liquid to get inside the charger. Electric shock may result.



WARNING! Never modify the power tool or any part of it. Damage or personal injury could result.



CAUTION! Burn hazard. To reduce the risk of injury, charge only DEHAN rechargeable battery packs. Other types of batteries may overheat and burst resulting in personal injury and property damage.

NOTE: Under certain conditions, with the charger plugged into the power supply, the charger can be shorted by foreign material. Foreign materials of a conductive nature, such as, but not limited to, grinding dust, metal chips, steel wool, aluminum foil or any buildup of metallic particles should be kept away from the charger cavities. Always unplug the charger from the power supply when there is no battery pack in the cavity. Unplug the charger before attempting to clean.

COMPONENTS AND SPECIFICATIONS

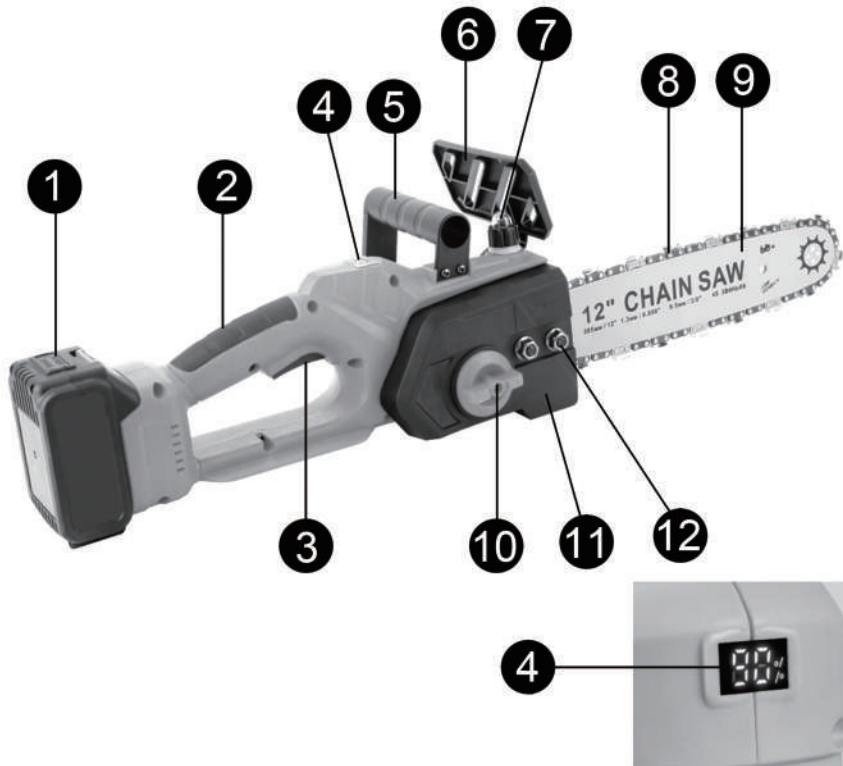

PRODUCT INTRODUCTION:

- | | |
|--------------------------------------|----------------|
| 1. Battery pack | 7. Oil tank |
| 2. Non-slip handle | 8. Saw Chain |
| 3. Switch | 9. Guide Plate |
| 4. Display | 10. Cover Knob |
| 5. Lift hand handle | 11. Side Cover |
| 6. Brake switch grass blocking board | 12. Fixed Nut |

| | |
|------------------------------|-------------------------|
| Model | DSC-0689 |
| Voltage | 21V |
| Battery Specification | Li-ion, 4.0 Ah, 4000mAh |
| Battery Charge | 120V, 60Hz |
| Maximum Power | 1000W |
| Working Time | Approx.40-60min |
| Charging Time | 3Hour |
| Chain Speed | 6.0m/s |
| Guide Plate Length | 12" |
| Weight (Bare Tool) | 4.8LBs |

SPECIFIC INSTRUCTIONS

Battery Installation

