

USER'S MANUAL

2 in 1 Countertop Ice Maker & Shaver Machine

SKU:VH835



Thank you for choosing our ice maker

Please read this Instruction Manual carefully before using this product so as to ensure proper use.

After reading this manual, please keep it in a safe place and refer to it when necessary.

Description

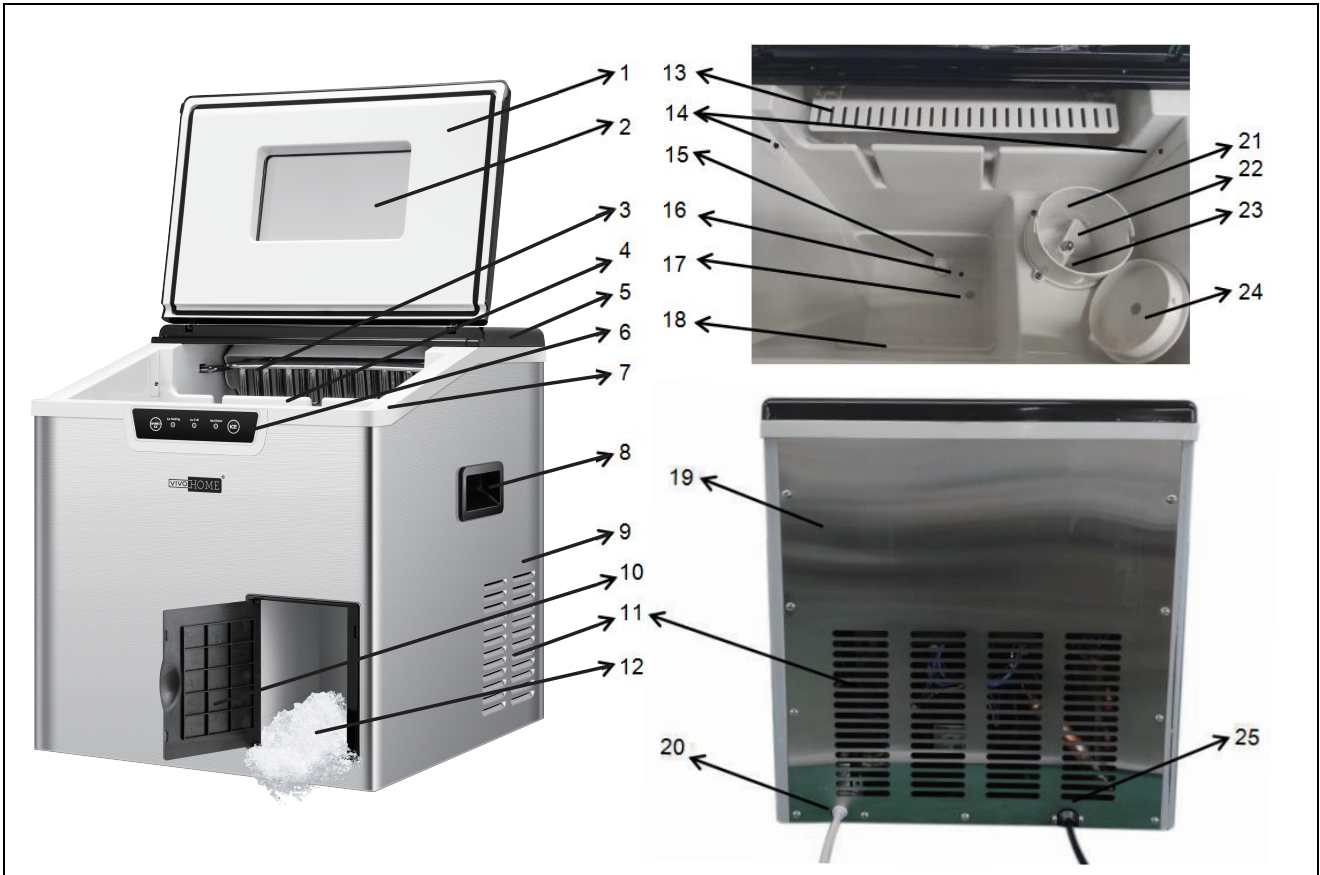

1	Front top lid	14	Ice full sensor
2	Viewing window	15	Water buoy
3	Evaporator	16	Water suction hole
4	Ice basket	17	Drain plug
5	Back top lid	18	Max water filling line
6	Control Panel	19	Back cover
7	Middle Frame	20	Water Inlet Hole
8	Handle	21	Shaved ice bowl
9	Housing	22	Shaving paddle
10	Decoration door	23	Knife
11	Fan Cover	24	Bowl cap
12	Shaved ice outlet	25	Power Cord and Plug
13	Ice shovel		

Specifications

Daily Ice Output: 15-20kg/24h

Ice Storage Capacity: 3kgs

Water Reservoir Capacity: 3L

Refrigerant: R600a / R290







Ice Shape: Bullet

Dimension: 378*398*420mm

Before/First Use of Your Ice Maker

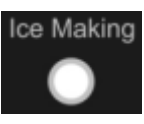
1. During transportation, the incline angle of the cabinet should not be over 45°. Do not turn the ice maker upside-down, as this may damage the compressor and sealed system.
2. Remove all packing material and carefully check your ice maker to ensure it is in good condition and that there is no damage to the ice maker or power cord and plug.
3. The ice maker should be placed horizontally on a level surface—to ensure proper ventilation for your ice maker, allow 150mm of space at the top, the back, and on each side. Do not install the Ice maker near an oven, radiator, or any other heat source.
4. Before using the Ice maker for the first time please wait 2 hours after positioning it and keep the front lid open for at least 2 hours.
5. Ensure that the voltage indicated on the ice maker corresponds with the voltage in your home.
6. Purified water is not allowed to be used in this unit—spring water is recommended.
7. Please always keep the viewing window closed during ice-making.

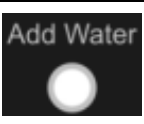
Control Panel Operation

	
Button/Indicator	Explanation
	<p>Press this button to shave ice.</p> <p>Before you press button, please put enough ice into the bowl and covers the bowl cover well.</p>
	<p>When this light illuminates in a solid color, the machine is making new ice.</p>
	<p>This lights up when the ice basket is full.</p>
	<p>This lights up when there is not enough water in the tank.</p>
	<p>Press this button to start the ice making process.</p>

Operation Instructions

Step 1.

Shaved ice may melt so it is strongly recommended to connect the drain pipe at bottom of the unit to pool

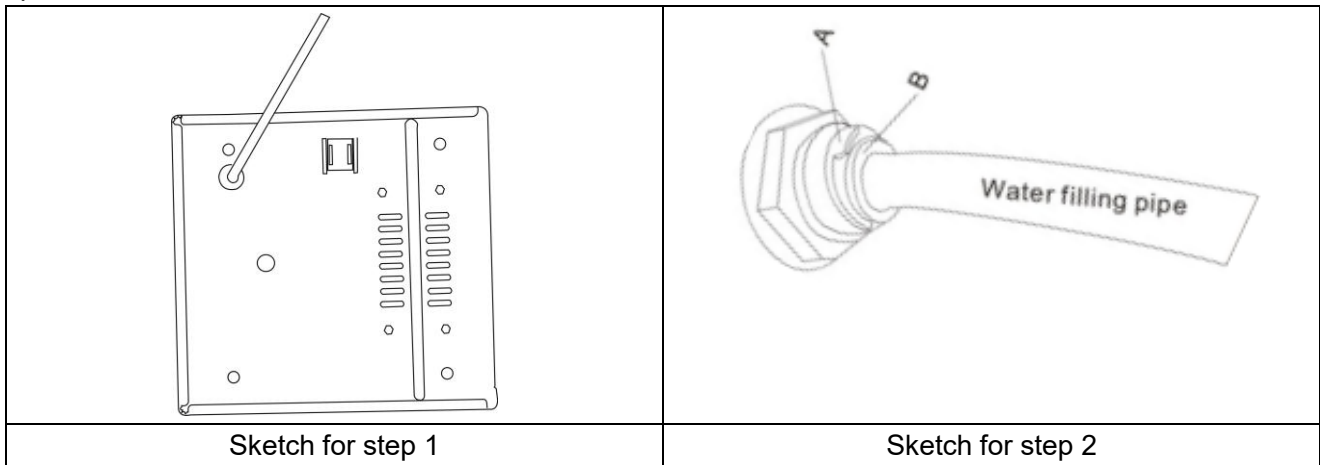

Step 2.

Open the lid, take out of the ice basket and fill the water reservoir with water.

Note: Make sure the water is not over the bottom of the ice collecting tray.

If you prefer to fill the water automatically then insert the water pipe into the socket at back of the unit as below.

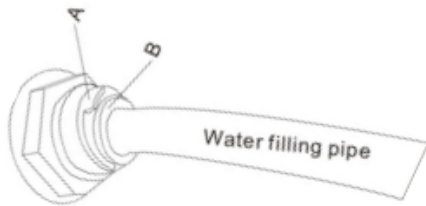

Step 3.



Connect to the power.

Step 4.

Press  button to turn unit on. The ice maker begins to work.

Note: For the first three cycles, the ice may be small and irregular in size, or even no ice.

Step 5.

If indicator  lights up, please take out the basket, then add water as per step 1, then press  to restart the ice maker

Step 6.

If indicator  lights up, please take out the ice with the scoop.

Note: When the ice basket is full please remove the ice immediately, Do not allow the ice collecting tray overflow.

Step 7.

Press  button to shave ice.

Note: Before the press of this button, please put enough ice into the shaved ice bowl and cover the bowl cap well.

Step 8.

Press  button to stop the machine.

Step 9.

Put a tank in below the unit, then pull the unit a little forward, pull the drain plug at middle of the tank to drain water.

Step 10.

If you want to take off the pipe, sketch as above: first, take off the blue ring A (if any), then press the white ring (lock) at the outer side B. Finally take out the pipe.

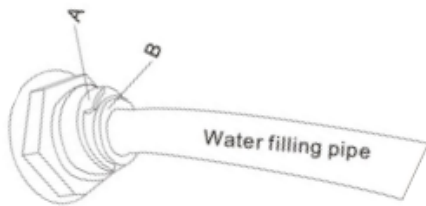

Caring

1. Clean the inner liner, ice collecting tray, water box, ice shovel, and evaporator frequently. When cleaning, unplug the unit and remove the ice cubes. Use a diluted solution of water and vinegar to clean the inside and the outside surface of the Ice maker. Do not spray Ice maker with chemicals or diluted agents such as acids, gasoline, or oil. Rinse thoroughly before starting.
2. Keep ventilation openings in the appliance enclosure, or in the built-in structure, clear of all obstruction. Do not use mechanical devices or other means to accelerate the defrosting process, other than those recommended by the manufacturer.
3. To ensure the cleanliness of the ice cubes, water in the water reservoir is suggested to be replaced every 24 hours.
5. If the compressor stops for any reason such as water shortage, too much ice, power off, etc... Do not start the system right away, wait 3 minutes, and then re-start the Ice maker.
6. Always use fresh water before starting ice production either at initial installation or after a long shut-off period.
7. This unit is for home use only, not for outdoor use. If it you need to use the device outdoors please ensure that the view window is closed properly.

Safety Notice

In order to avoid any accidents, please refer to following operation:

1. Disconnect power before servicing.
2. Do not pull directly on wire when plugging or unplugging the unit.
3. If ice is abnormal, please call the seller.
4. It is normal for the compressor and condenser surface to reach temperatures between 70°C and 90°C during operation and surrounding areas may be hot. Please do not touch the device.
5. Due to fast freezing, ice cubes may appear "Cloudy". This is trapped air in the water and it will not affect quality or taste of ice.

6. When out of use, please open the drawer at least 2cm to allow for air circulation and avoid any metallic components becoming rusted.
7. If the supply cord is damaged, it must be replaced by the manufacturer or its service agent or a similarly qualified person in order to avoid any hazards.
8. This appliance can be used by children aged from 8years and above and persons with reduced physical, sensory or mental capabilities or lack of experience and knowledge if they have been given supervision or instruction concerning use of the appliance in a safe way and understand the hazards involved.
- 9.Children must not play with the appliance.
Cleaning and user maintenance shall not be made by children without supervision
10. WARNING: fill with bottled or good quality tap water only (Do not fill with fruit juices or other drink types).
11. WARNING – Keep the air vents on the sides of the machine unblocked at all times.
12. WARNING – Do not use mechanical devices or other means to accelerate the defrosting process, other than those recommended by the manufacturer.
13. WARNING – Do not damage the refrigerant circuit.
14. WARNING – Do not use electrical appliances inside the food storage compartments of the appliance, unless they are of the type recommended by the manufacturer.

Troubleshooting

1. Please note, if a power failure occurs due to disconnection of the power cord, or the off power button has been pushed off during an ice making cycle, small ice chips may formed and lodge in the automatic shovel causing it to jam. If this occurs, the ice chips may be removed by disconnecting the power cord and gently pushing the shovel to the rear of the cabinet and removing the ice chips, then restarting.
2. Please restart the ice maker by pressing Stop and then Start. If the Ice shovel does not push the Ice into the Ice collector after the formed Ice drops from the evaporator finger while at the same time the M light is on, check to see if the water tray is horizontal or balanced. If not then adjust by pressing the Ice shovel lightly with your finger. Then re-start the Ice maker.

The compressor works abnormally with a Buzzing noise	Reasons	The voltage is lower than recommended
	Solutions	Stop the Ice maker and do not restart until the voltage is normal.
Conditions for Ice making Cycle are right but no ice is made.	Reasons	Refrigerant leaks/ Sealed system is blocked
	Solutions	call for service
The lights of ice full and add water come at in the same time.	Water tray is blocked by ice cube.	Clear the ice cube under the ice shovel pull out the plug and insert It again then press the  button, 3 minutes later the machine will restart automatically.
Machine keeps running, but the water is warmer than the normal water.	The magnetic valve is broken.	Replace the magnetic valve.

**Thank You For Purchasing From
VIVOHOME**

✉ support@vivohome.com

www.vivohome.com

MADE IN P.R.C