



OWNER'S MANUAL

LG CineBeam Laser 4K

DLP Projector

Please read the safety information carefully before using this product.

HU915QE (HU915QE-GL)

HU915QB (HU915QB-GL)

www.lg.com

Copyright © 2022 LG Electronics Inc. All Rights Reserved.

CONTENTS

PREPARATION

INSTALLATION

- 10 How to use the edge guards
- 11 Ceiling-Type Installation
- 12 Projection Distance per Screen Size
- 14 Adjusting the Focus of the Projection Screen
- 16 Kensington Security System

USING MAGIC LIGHTING REMOTE

- 17 Inserting Batteries in the Remote Control
- 18 Viewing the Remote Control Features
- 22 To Register the Magic Lighting Remote
- 22 To Re-register the Magic Lighting Remote
- 23 Using the Magic Lighting Remote

CONNECTING DEVICES

- 25 Connecting with a HDMI Cable
- 26 Connecting a Digital Amp
- 27 Connecting a smart device (smartphone, tablet, etc.)

SAFETY PRECAUTIONS

CHECKING BEFORE REPORTING MALFUNCTION

- 40 Projector Safety Check
- 41 Troubleshooting

CHECKING INFORMATION

- 43 Specifications
- 44 HDMI Supported mode
- 48 Licenses
- 48 Open Source Software Notice Information
- 49 Other specifications
- 50 Symbols

This manual is produced for public use and may contain images or contents different from the product you purchased.

This manual is subject to change depending on the company's circumstances.

PREPARATION

The pictures may differ slightly from the actual product.

Accessories

Accessories included with the projector are show below.

Accessories are subject to change without prior notice.

New accessories may be added or old ones removed.

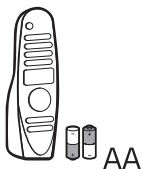

Magic Lighting Remote
Two AA Batteries



Owner's Manual



Power cord



Edge guards

- When connecting an HDMI or USB cable, or connecting a USB flash drive to the HDMI or USB port, use a product that has a width of 18 mm (0.7 inches) or less and a height of 10 mm (0.3 inches) or less. If the USB cable or USB flash drive does not fit the USB ports of the projector, use an extension cable that supports USB 2.0.

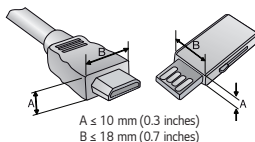

- When connecting two USB devices at the same time, each one should have bezels less than 8.5 mm (0.3 inches) thick.
- Use a certified cable with the HDMI logo attached.
- If you do not use a certified HDMI cable, the screen may not display or a connection error may occur. (Recommended HDMI cable types)
 - Ultra High Speed HDMI[®]/TM Cable (3 m (9.8 feet) or less)

Optional Extras

To purchase optional accessories, visit an electronics store or online shopping site or contact the retail store where you purchased the product. Optional accessories are subject to change without prior notice.



Projection Screen

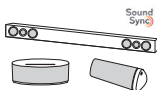

LG Audio Device



HDMI Cable



Optical Cable

Parts and Components

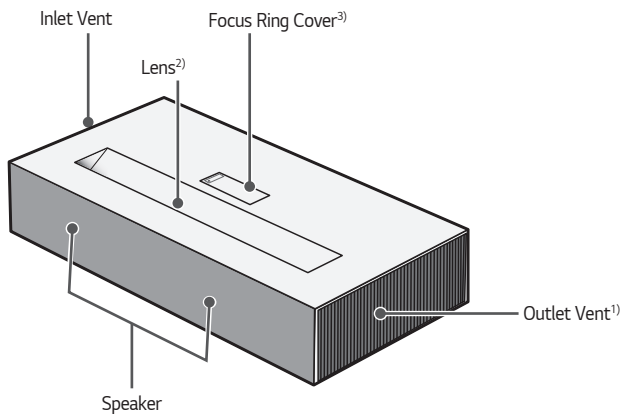

- 1) Due to the high temperature of vent area, do not get close to the vent area.
- 2) Do not touch the lens when using the projector. The lens may be damaged. (Keep lens away from sharp objects.)
- 3) Be careful not to get your fingers caught when closing the projector's door. (This may cause injury to people or a malfunction of the product.)

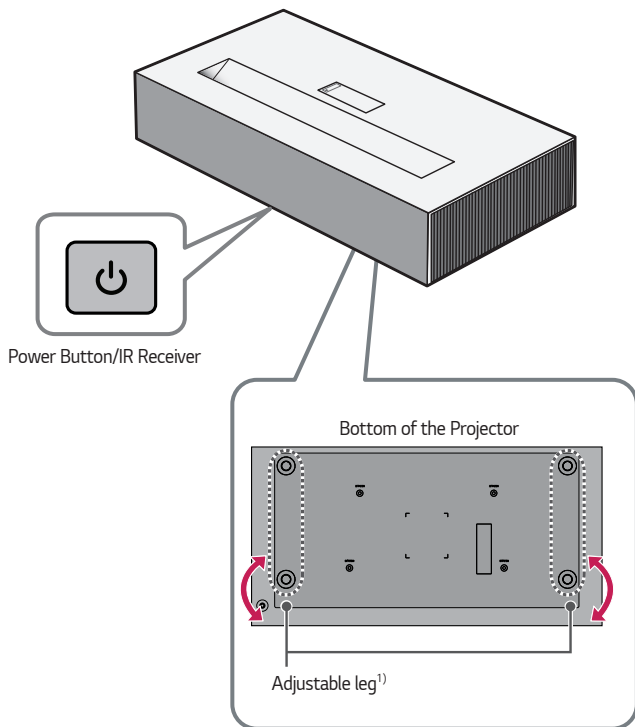

1) Turn the adjustable leg left or right to adjust the angle.

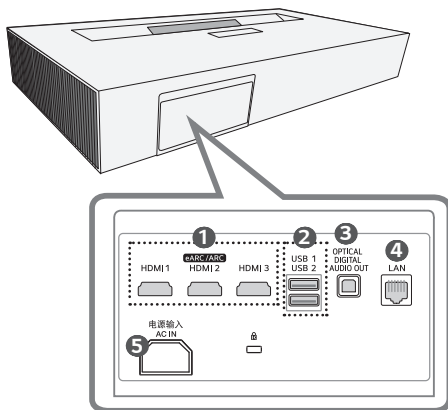

- ① HDMI Port
- ② USB Port
- ③ OPTICAL DIGITAL AUDIO OUT Port
- ④ LAN Port
- ⑤ 电源输入 AC IN (AC IN Port)

Using the Power Button



The projector can be turned on and off with the  **Power** button on the product.
— A short press turns it on, a long press turns off all functions and the screen.

NOTE

- The shape and location of the power button may vary depending on the model of the projector.
 - When the power is turned on for the first time, the initialization of the projector may take approximately one minute.
-

Adjusting the menu

When the projector is on, press the  **Power** button once to display the power, volume control, and external input source menus at the bottom of the screen. Press and hold the button to select or change the menu.

-  Turns the power off.
-  Changes the input source.
-  Adjusts the volume level.

Projector Status Indicators

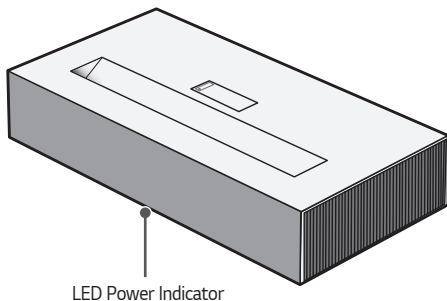

LED Power Indicator	
Red	Power standby state
Red(Blink)	Powering On
Off	The projector is operating with the power on.

INSTALLATION

How to use the edge guards

It prevents any damage to the product and injury when being attached to sharp edges of the product.

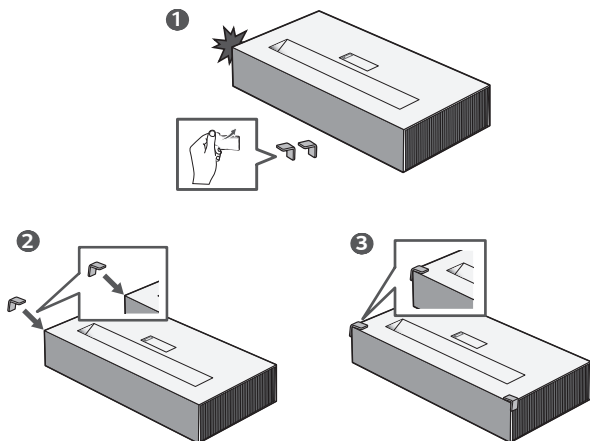

Ceiling-Type Installation

WARNING

When installing the product on the ceiling, observe the following precautions to prevent the projector from falling:

- It is recommended to install the product through a professional installation services provider. (If installing on the ceiling, modify the projector's PJT Mode settings)
- Do not use adhesive, lubricant, oil, etc. when using the mounting equipment.
- Do not tighten the screws with an excessive force since the projector may fall due to breakage of the screw connection part.
- Standard screw: M4 x 8 mm, M6 x 10 mm, 1/4-20 UNC x 5 mm (Applicable screw types may vary depending on the model.)
- Recommended torque: 5-8 kgf.cm (4.34-6.94 lbf-in)
- A failure to follow the precautions may result in injury or death and product damage due to the fall of the product.

Projection Distance per Screen Size

- 1** Place the projector on a sturdy, level surface, together with the PC or audio/video source.
- 2** Place the projector an appropriate distance away from the screen. The distance between the projector and the screen determines the actual size of the image.
- 3** Position the projector so that the lens is at a right angle to the screen. If the projector is not at a right angle, the projected image will look distorted. To correct the distortion, use the Edge Adjustment function.
- 4** Connect the power cord of the projector and the connected device to the wall outlet.

Ratio of upward projection: 120 %

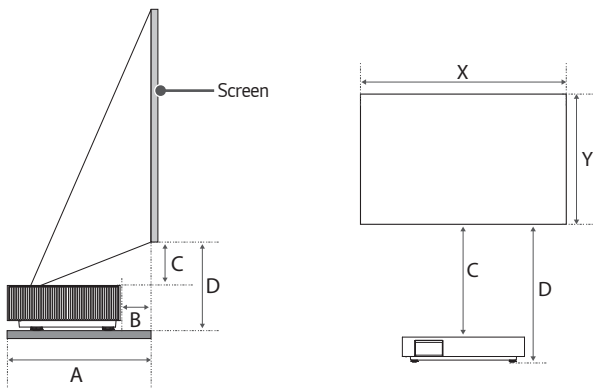

Screen Size	inches	90	95	100	105	110	115	120
	mm	2286	2413	2540	2667	2794	2921	3048
Screen Height (X) x Screen Width (Y)	inches	78.4 x 44.1	82.7 x 46.5	87.1 x 49.0	91.4 x 51.4	95.8 x 53.9	100.2 x 56.3	104.6 x 58.8
	mm	1992 x 1121	2103 x 1183	2214 x 1245	2324 x 1308	2435 x 1370	2546 x 1432	2657 x 1494
A	inches	15.8	16.6	17.5	18.3	17.6	20.0	20.8
	mm	403	424	445	466	488	509	530
B	inches	2.2	3.0	3.8	4.6	5.5	6.3	7.2
	mm	56	77	98	119	141	162	183
C	inches	7.1	7.6	8.1	8.6	9.1	9.6	10.1
	mm	182	195	207	220	232	245	257
D	inches	12.6	13.1	13.6	14.0	14.6	15.0	15.5
	mm	321	334	346	358	371	383	396

The projection distance may vary depending on the installation conditions.

NOTE

- If the projected image looks distorted or bent, check to see if the screen is installed properly.

Adjusting the Focus of the Projection Screen

When an image appears on the screen, check if it is in focus and fits the screen properly.

- 1 Press  (**Edge Adjustment**) button on the remote control to execute the [Edge Adjustment] function.
- 2 Move the projector to the left or right to check that the projection fits on the screen.

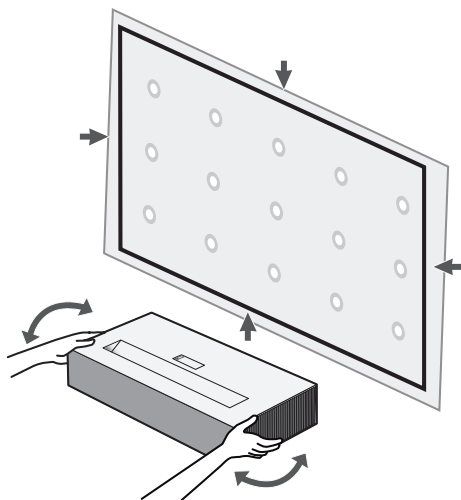

- 3** To adjust the focus of the image, slowly adjust the focus ring to the left or right while looking at the top center of the screen. You can adjust the focus most effectively when the left and right screen are balanced. When adjusting the focus on the screen, do not let the product shake.
- Before using the focus ring, press the side (▼) of the focus ring cover once to open the cover. Please open the focus ring cover before using the focus ring.
- 4** If the angle of the projection is not perpendicular, use the [Edge Adjustment] function. (Use the Up/Down/Left/Right buttons on the remote control to adjust the top/bottom/left/right of each angular point.)

 **NOTE**

- After using the product at room temperature, turning on the power may blur the focus if the inside temperature is low, but it will recover over time.
 - This defocusing is a temporary phenomenon that occurs in low-temperature environments, and this will not affect the product's performance or lifespan.
-

Kensington Security System

- This projector has a Kensington Security Standard connector as an anti-theft mechanism. Connect a Kensington Security System cable as shown below.
- For more information on installation and use of the Kensington Security System, refer to the user's guide provided with the Kensington Security System.
- The Kensington Security System is an optional accessory.
- What is Kensington?

Kensington is a company that provides safety systems for laptops and other electronic devices. Website: <http://www.kensington.com>

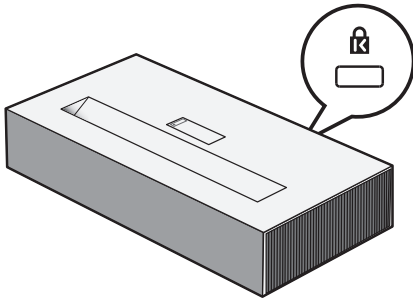

USING MAGIC LIGHTING REMOTE

- Depending on country

Inserting Batteries in the Remote Control

If the battery low message appears while using the Projector, replace the batteries. Use 1.5 V, AA-type alkaline batteries. Replace the two batteries with new ones and insert them according to the direction indicator inside the remote control.

- 1** Remove the battery cover on the back of the remote control by sliding it downwards.
- 2** Insert the batteries to match the +, - polarity symbols.
- 3** Close the battery cover.

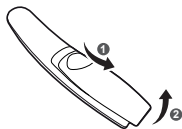

CAUTION

- Do not mix new batteries with old ones.

Viewing the Remote Control Features

*: To use the button, press and hold for more than 3 seconds.

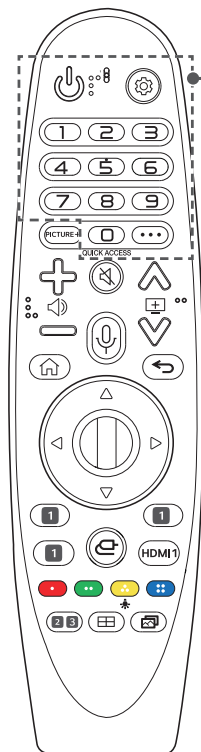

 (POWER)

Turns the Projector on or off.

 (Q. Settings)

Accesses the Quick Settings.

 (Q. Settings) *

Displays the [All Settings] menu.

Number buttons

Enters numbers.

 *

Accesses the [Quick Help].

QUICK ACCESS*

Edits QUICK ACCESS.

(QUICK ACCESS is a feature that allows you to enter a specified app directly by pressing and holding the number buttons.)

 (MORE ACTIONS)

Displays more remote control functions.

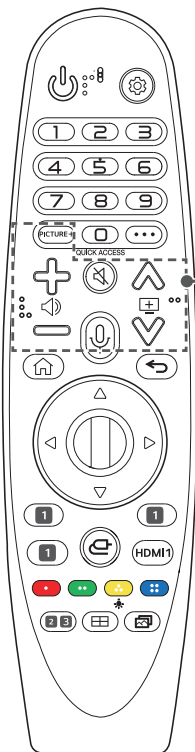

PICTURE+

The menu appears in the order of [Iris Mode]/[Adaptive Contrast]/[HDR Tone Mapping]/[Cinema Screen]/[TruMotion].

Depending on the input signal or video mode setting, the menu may deactivate and disappear from the screen.

The configurable items differ depending upon model.

- [HDR Tone Mapping]: When the signal is not HDR10
- [Cinema Screen]: When the input signal is not 24 Hz/When [Picture Mode] is [Game Optimizer]/When set to [TruMotion]
- [TruMotion]: When the input signal is HDMI-PC/When [Picture Mode] is [Game Optimizer]



Adjusts the volume level.



Mutes all sounds.



Accesses the [Accessibility] menu.



Network connection is required to use the voice recognition function.

Check for recommended content. (Some recommended services may not be available in some countries.)



Speak while pressing and holding the button to use the voice recognition feature.



Moves to the previous/next page.

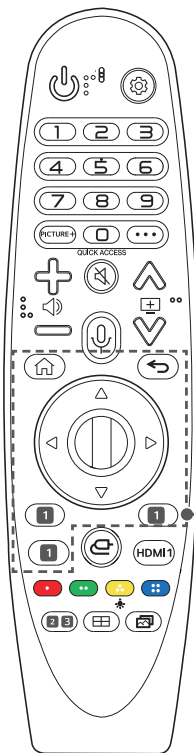

Accesses the Home menu.



Launches the last used apps.



Returns to the previous screen.



Clears on-screen displays and returns to last input viewing.

△ ▽ ◀ ▶ (Up/Down/Left/Right)

Press the up, down, left or right button to scroll the menu. If you press △ ▽ ◀ ▶ buttons while the pointer is in use, the pointer will disappear from the screen and the Magic Lighting Remote will operate like a general remote control. To display the pointer on the screen again, shake the Magic Lighting Remote to the left and right.

⓪ Wheel (OK)

Press the center of the Wheel button to select a menu. You can move cursor or menu by using the Wheel button.

1 Streaming Service buttons

Connects to the Video Streaming Service.

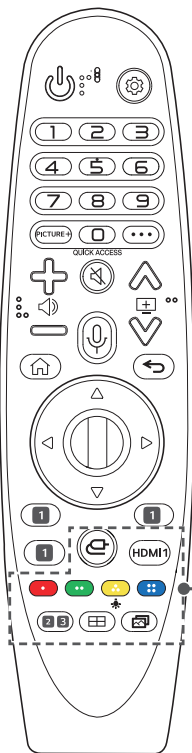

(INPUT)

Changes the input source.

(INPUT) *

Accesses the [Home Dashboard].

HDMI 1

Change the input source to [HDMI 1].



These access special functions in some menus.



The remote control buttons light up so that you can use the remote control in the dark.

If the remote control does not move, the pointer disappears and the remote control light turns off in about 5 seconds.

The lighting function is applied when the product is shipped, and if you press and hold the  button for more than 5 seconds, the **(POWER)** button flashes twice and you can turn the lighting function on or off.

2 (Sound Mode)

Changes the [Sound Mode].

3 (Aspect Ratio)

Changes the aspect ratio of the screen per pressing of the button.

(Edge Adjustment)

Execute [Edge Adjustment].

(Picture Mode)

Changes the [Picture Mode].





To Register the Magic Lighting Remote

You must pair the Magic Lighting Remote with the projector to use it.

Pair the Magic Lighting Remote prior to use as follows.

- 1 Put batteries into the Magic Lighting Remote and turn the Projector on.
 - 2 Point the Magic Lighting Remote at your projector and press the  **Wheel (OK)** on the remote control.
- If the projector fails to register the Magic Lighting Remote, try again after turning the projector off and back on.

To Re-register the Magic Lighting Remote

- 1 Press the  and  buttons at the same time, for five seconds, to unpair the Magic Lighting Remote with your projector.
 - 2 Press the  **Wheel (OK)** button towards the projector to re-register the Magic Lighting Remote.
- Hold the remote control towards the projector and press the  and  (**Q. Settings**) buttons at the same time more than 5 seconds until instructions appear. The previously registered remote control is deregistered and then registered again.

Using the Magic Lighting Remote

- If you shake the Magic Lighting Remote left and right or turn its wheel while pointing it at the projector, a pointer will appear on the projector screen. If you move the remote control in the direction you want, the pointer follows the movement.

Move the pointer to the location you want and press the  **Wheel (OK)** button to execute the function.

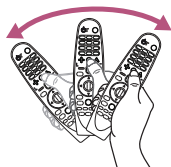
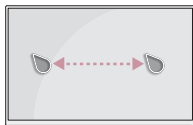

- You can set the pointer speed and size you want while it is on the screen.
⚙️ **(Q. Settings)** → ⋮ → [General] → [System] → [Additional Settings] → [Pointer Options]
 - [Tracking Speed]: Sets the pointer speed.
 - [Pointer Size]: Selects the pointer size.
- If the pointer has not been used for a certain period of time, it will disappear. When the pointer disappears from the screen, shake the Magic Lighting Remote right and left.
The pointer will disappear if you press the up, down, left, right buttons, and the remote will work as a conventional remote.
- If the pointer is not responding smoothly, you can reset the pointer by moving it to the edge of the screen.
- Use the remote control within the specified range (within 10 m (32.8 feet)). You may experience communication failures when using the device outside the coverage area or if there are obstacles within the coverage area.
- You may experience communication failures depending on the accessories. Devices such as a microwave oven and wireless LAN operate in the same frequency band (2.4 GHz) as the Magic Lighting Remote. This may cause communication failures.
- Impacts can cause the Magic Lighting Remote to malfunction.
- Take care not to bump into nearby furniture, electronic equipment, or other people when using the Magic Lighting Remote.
- The Magic Lighting Remote may not work properly if a wireless router (AP) is within 0.2 m (0.6 feet) of the Projector. Your wireless router should be more than 0.2 m (0.6 feet) away from the Projector.

CONNECTING DEVICES

You can connect various external devices to the projector.

Connecting with a HDMI Cable

Connect an HD receiver, DVD, PC, Notebook, or external devices to the projector and select an appropriate input mode.

With an HDMI cable, you can enjoy high quality picture and sound.



Using a HDMI cable, connect the **HDMI** port of the projector to the HDMI output port of the device to connect. Both video and audio are output at the same time.

-  (**INPUT**) → [Home Dashboard] → [Inputs] → [HDMI 1]/[HDMI 2]/[HDMI 3]



✓ NOTE

ARC (Audio Return Channel)



- External audio devices that support SIMPLINK and ARC must be connected using  port. 
- When connected with a Ultra High Speed HDMI[®]/TM Cable, external audio devices that support ARC output or SPDIF work with the SIMPLINK function without the need for an additional optical audio cable.

When connecting PC/laptop

- The projector supports Plug and Play. Your PC will automatically detect the projector and requires no driver installation.

Connecting a Digital Amp

Using an optical cable, connect the digital audio input port of a digital amp to the **OPTICAL DIGITAL AUDIO OUT** port of the projector. The output of an amp with a digital converter must be set to the desired audio format. If a projector, home theater, or the speaker of an external audio device is operating at the same time, there will be an echo.

-  (**Q. Settings**) →  → [Sound] → [Sound Out] → [Use Wired Speaker] → [Optical Out Device]



Optional Extras



✓ NOTE

- Refer to the user manual of the audio device to connect.
- When connecting this product to other devices, make sure to turn off and unplug all the devices.
- The audio output of this product has wide-ranging audio bandwidth, so the receiver volume must be adjusted properly. Speakers can be damaged by unexpected high frequencies.
- Connecting the **OPTICAL DIGITAL AUDIO OUT** port of the projector to the digital audio input port of a digital amp and the audio input port of the projector to the analog audio output port of the digital amp can cause sound oscillation due to the closed loop. Remove one of the two connections to prevent this. (This also applies to home theater devices.)

Connecting a smart device (smartphone, tablet, etc.)

-  (INPUT) → [Home Dashboard] → [Inputs] → [HDMI 1]/[HDMI 2]/[HDMI 3]
- The picture may look different from the actual product.

Connect a smart device to the projector using a cable¹⁾ and set the external input of the projector to HDMI. The smart device screen will then be displayed through the projector. You can connect with any HDMI input port.

For model-specific instructions regarding use of the wired connection, please check with the smart device manufacturer.

Supported smart devices may change depending on the circumstances of each manufacturer.

1) Examples of how to connect a cable to different smart devices (cable purchased separately).

Slimport supported devices

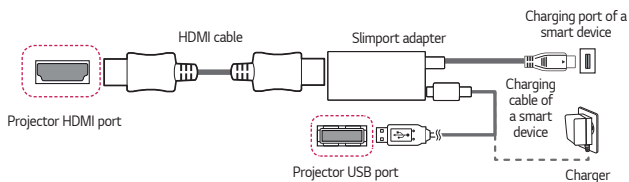

Apple Lightning Digital AV adapter supported devices

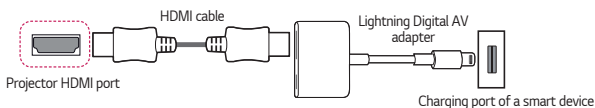

Apple 30-pin Digital AV adapter supported devices

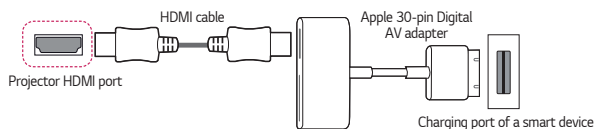

SAFETY PRECAUTIONS

Please take note of the safety instructions to prevent any potential accident or misuse of the projector.

Child injuries can be prevented by following these simple safety precautions.

The precautions should be followed in the same manner when you store or move your existing projector.

- Safety precautions are given in two forms, i.e., **WARNING** and **CAUTION** as detailed below.

 **WARNING:** Failure to follow the instructions may cause serious injury and even death.

 **CAUTION:** Failure to follow the instructions may cause personal injury or product damage.

- Read the owner's manual carefully and keep it on hand.



The lightning flash with arrowhead symbol, within an equilateral triangle, is intended to alert the user to the presence of uninsulated dangerous voltage within the product's enclosure that may be of sufficient magnitude to constitute a risk of electric shock to persons.



The exclamation point within an equilateral triangle is intended to alert the user to the presence of important operating and maintenance (servicing) instructions in the literature accompanying the device.

WARNING/CAUTION

- TO REDUCE THE RISK OF FIRE AND ELECTRIC SHOCK, DO NOT EXPOSE THIS PRODUCT TO RAIN OR MOISTURE.

Read these instructions. Keep these instructions.

Heed all warnings. Follow all instructions.

Indoor Installation

WARNING

Do not install products including projectors and remote controls in the following places:

- Any place exposed to direct sunlight;
 - Any humid place such as bathroom;
 - Any place near hot objects such as flammables and stoves;
 - Any place where oil, oil mist, and steam can reach such as a worktop or places near a humidifier;
 - Any place where water can splash like a vase or the aquarium;
 - Any place that is dusty or exposed to wind and rain;
 - Any place that is under the air conditioner or is directly exposed to the wind from the air conditioner;
 - Any place near flammable materials such as flammable sprays, etc.; or
 - Any cupboard, bookcase shelf or cabinet without a fixture installed and any place where a pet can access.
- It may cause an electric shock, fire, malfunction, deformation or falling.

Be careful not to drop the projector when connecting an external device.

- It may cause injury or damage to the product.

Keep the following precautions in mind to prevent the temperature rise inside the projector:

- Install the air vents at least 30 cm (11.8 inches) away from the wall.
- Do not install the product in a place where it cannot be ventilated, such as on a bookcase or in a closet.
- Do not install the product on carpet or cushion.
- Make sure that the air vents are not blocked with tablecloths, curtains, etc.
- It may cause a fire.

For places where oil or oil mist can reach, do not install the product on a wall or ceiling.

- The product may be damaged and fall.

Do not allow a child to hang or climb on the installed projector.

- The projector may fall and cause injury or death.

 CAUTION

When moving the projector, be sure to turn off the power switch and disconnect the power plug, antenna cable and the connection cord between the devices.

- A failure to do so may cause damage to the projector or the cord, resulting in a fire or electric shock.

Do not install the projector on a shaky shelf, a slanted place, a place subject to vibrations, a place where the projector is not fully supported or on a fabric such as tablecloths.

- It may cause injury as the projector falls or tips over, or it may cause a malfunction of the projector.

To prevent damage to the power cord or plug, do not install the projector where the cord can be walked on.

- It may cause a fire or electric shock.

When installing the projector, do not install it too close to the wall.

- The cable connection may be deteriorated or the projector and its cables may be damaged.

When installing the projector on a cabinet or a shelf, make sure that the front end of the bottom of the projector does not come out.

- The projector may fall due to the unbalance of the center of gravity and cause injury to people or a malfunction.

When in Use

WARNING

When thunder or lightning strikes, unplug the power cord and do not touch the antenna wire.

- It may cause an electric shock.

If there is a gas leak from the gas lines, do not touch the outlet and be sure to vent by opening the window.

- Sparks may be caused and lead to a fire or burns.

When using the product with an external device connected such as a games console, make sure the connection cable is long enough.

- The product may fall over and cause injury or product damage.

Do not scratch or give an impact on the projector with metallic materials or objects.

- It may cause injury to people or damage to the product.

Do not insert metallic objects including coins, hairpins or a piece of iron or flammable objects such as paper or matches into the projector.

- It may cause a fire or electric shock.

When replacing the batteries used for the remote control, be careful not to let children eat them and keep the batteries out of reach of children.

- If a child swallows the battery, consult a doctor immediately.

Keep the plastic wrapping of the product out of the reach of children.

- If a child misuses it, it may suffocate the child.

Do not touch near the vents during the operation or immediately after the power is turned off as they generate intense heat.

- The heat does not indicate a defect or a problem of the projector when it is operating so use it with confidence.

Do not look into the front of the lens when the projector is operating. Strong light is projected from the product which can cause injury to your eyes.

Never try to disassemble or modify the projector yourself. Always seek a qualified service technician or consult your dealer or local Service Center for inspection, adjustment or repairs.

- It may cause a fire or electric shock.

 **CAUTION**

Do not use any product that uses high voltage electricity near the projector. (e.g. An electric fly swatter)

- It may cause a malfunction.

Do not place any liquid containers such as a vase, pot, cup, cosmetics or medicine, decorations such as candles or any heavy objects on top of the projector.

- Doing so may cause a fire, electric shock and injury due to failing.

The surface of the AC adapter is hot, so be careful not to put the surface against your skin or let the children touch the surface during use. (Except for the models that do not use an adapter)

Do not hold or move the projector upside down by grabbing only the power cord, signal cable, or projection mirror.

- Doing so may damage the product or cause an electric shock or fire.

Even if the projector is turned off with the remote control or the button, the power is not completely cut off if the power cord is plugged in.

If you use headphones or earphones, do not use them at high volume or for a long period of time. (It applies only to the models that support headphones (earphones).)

- Doing so may damage your hearing.

Do not start the projector when the volume is high.

- A loud volume can cause hearing loss.

Do not use or store the projector outdoors for an extended period of time.

Do not touch the projector's lens or give an impact on it.

- It may cause damage to the product.

Do not block the light from the projector lens with a person, book or other objects.

- If the light from the projector shines on an object for a long time, it can cause fire due to the heat of such light. Also, the reflected light can heat the lens and cause damage to the projector.

Do not mix old and new batteries together.

- It may cause battery rupture or fire due to liquid leakage or may cause electrical shock.

When replacing the batteries, make sure that they are properly installed according to the polarities (+, -).

- Battery rupture or leakage may lead to fire, explosion, injury or contamination (damage) of the surrounding area.

Do not expose the batteries to direct sunlight, fireplace, electric heater, high temperature above 60 °C (140 °F), excessively humid places or excessive heat.

- It can cause an explosion or fire.

Do not throw or disassemble the battery.

- It can cause a fire and explosion due to battery damage.

Do not carelessly throw away old batteries.

- It can cause an explosion or fire. The disposal method may vary by country and region. Dispose of it in an appropriate manner.

Risk of fire or explosion if the battery is replaced by an incorrect type.

Supervise children and to never allow them to stare into the projector beam at any distance from the projector.

Use caution when using the remote control for staring the projector while in front of the projection lens.

The user to avoid the use of optical aids such as binoculars or telescopes inside the beam.

Power



Make sure the power plug is securely plugged in to prevent it from shaking.

- If the connection is unstable, it may cause a fire.

Do not plug too many devices into one multi-power outlet.

- This may result in fire due to the power outlet overheating.

Do not insert a metal object such as chopsticks into the other end of the power plug while it is plugged into a wall outlet. Also, do not touch the power plug immediately after unplugging it from the outlet.

- It can cause an electric shock.

Connect the power plug to a grounded outlet or multi-tap. (Except for any device without ground connection)

- A failure to do so may cause an electric shock due to a malfunction or electrical short.

Never touch the power plug with wet hands.

- It may cause an electric shock.

Disconnect the power plug from the outlet when you are not using the projector for a long time or absent.

- Dust collects and may cause an electric shock and fire caused by a short circuit due to heat, ignition and insulation/degradation.

The Power Plug is the disconnecting device. In case of an emergency, the Power Plug must remain readily accessible.

If any of the following occurs, it could be a malfunction of the product, so you must immediately turn the projector off, unplug the power cord from the outlet, and contact the service center:

- When the product is damaged;
 - When the product fails;
 - When there is a foreign substance inside the product; or
 - When the product smokes or smells.
- It may cause a fire or electric shock.

 **CAUTION**

Do not unplug or plug the power plug from/in the outlet while the power switch is on. (Do not use the power plug as a switch.)

- It may cause a fire or malfunction.

When removing the AC adapter or power cord, be sure to hold the plug part.

- A failure to do so may cause a fire or damage to the product.

Do not damage the AC adapter, power cord or power plug, place heavy objects on them or give an impact on them.

- It may cause a fire, electric shock or damage to the product.

Attach the power cord and AC adapter connected to the projector in a way that they are fully seated.

- Poor contact can cause a malfunction of the product and fire.

If there is dust on the pin part of the power plug or the outlet, clean it thoroughly.

- It may cause a fire.

Keep the power cord away from heat sources.

- The coating of the cord may melt and cause a fire or electric shock.

Use only the authorized power cord or AC adapter supplied by LG Electronics. Do not use any other products.

- It may cause a malfunction of the product, fire or electric shock.

Cleaning

WARNING

Do not spray water directly onto the projector when cleaning it.

- It may cause a fire or electric shock.

CAUTION

How to clean the projector

- Disconnect the plug from the outlet before cleaning.
- Do not wipe the optical system (the lens and mirror) immediately after the power is turned off.
- Do not spray the water with a sprayer on the product or wipe the product with a damp cloth.
- Wipe the product gently with a soft cloth.
- Do not use any detergents, automotive or industrial polishes, abrasives, waxes, benzenes or alcohols.
- It may cause a fire, electric shock or damage to the projector (deformation, corrosion, and breakage).

How to clean the lens

- Clean the lens if any dust or smudge appears on the surface of the lens.
- Clean the surface of the lens with an air sprayer or a soft, dry cloth.
- To remove dust or stains on the lens, use a compressed air duster, cotton swab, or soft cloth to gently wipe the lens.
- Never clean the lens when the projector is operating or immediately after the projector is turned off.
- Do not use any detergents, automotive or industrial polishes, abrasives, waxes, benzenes, alcohols, water, etc. on the lens, as they will damage the projector.

Consult your dealer or the service center for cleaning the interior of the product once a year.

- If you do not clean the interior of the projector for a long time while dust collects, it may cause a fire or malfunction.

Laser

WARNING

- You risk being exposed to laser radiation if you manipulate or alter the product in a way not specified in the user manual.
- Be sure not to let infants or people with diseases directly watch the light source.

CAUTION

- This product is a class 1 laser device that meets IEC 60825-1.

Built-in laser standard (class 4 laser module)

- Blue
 - Wavelength: 448 nm - 462 nm
 - Light output: approx. 95 W x 2
- Red
 - Wavelength: 636 nm - 642 nm
 - Light output: approx. 2.5 W x 12

Product Laser Class Label

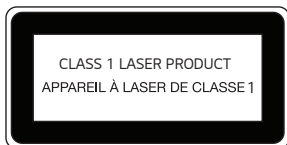

The laser class label of product is attached to the bottom of the product.

CHECKING BEFORE REPORTING MALFUNCTION

Please check the list below when you experience the following symptoms during use of the product. It may not be a failure.

Projector Safety Check

Symptoms

- The projector does not display anything on the screen or output sound when it is turned on.
- The product emits smoke or a burning smell.
- Water or foreign substances are present inside the product.
- Part of the projected image is cut out.
- A strange noise (crackling or sparking sound) regularly occurs from inside the projector.
- The projector still displays the screen or outputs sound when it is turned off.
- There are other errors or failures.

Causes and Solutions

- For safety, turn off the power switch and remove the plug from the socket.
- Contact the place of purchase or authorized service center for product inspection.
- Do not attempt to repair the product yourself.

Troubleshooting

Symptoms	Causes and Solutions
I cannot turn on the Projector.	<ul style="list-style-type: none"> • Please make sure your projector power plug is correctly connected to the outlet. • There may be a problem with the outlet, so try plugging the power cord of another product into the outlet where the projector was plugged in.
Cannot control the Projector with the remote control.	<ul style="list-style-type: none"> • The remote control may not work properly where a lamp with electronic stabilizer or a three-wavelength lamp is installed. <ul style="list-style-type: none"> — In this case, replace the lamp with electronic stabilizer or the three-wavelength lamp with international standard products to ensure the remote control works properly. • Check if there is any obstacle between the product and the remote control. • When replacing the batteries, make sure that they are properly installed according to the polarities (+, -). • Replace both used batteries with new ones.
The power turns off suddenly.	<ul style="list-style-type: none"> • Check whether the [Sleep Timer], [Auto Off], or [Auto Power Off] is set. • See if the external devices are operating together. • The auto-off function may have been activated. This product is equipped with an auto-off function that automatically turns the product off when no signal is present or when the remote control has not been pressed, depending on the settings for the auto-off function.

Symptoms	Causes and Solutions
<p>I see dots on the screen.</p>	<ul style="list-style-type: none"> • There is a colored dot (bright dots, dark dots, stationary dots, and/or flickering dots) on the screen. <ul style="list-style-type: none"> – This projector was produced with high precision technology. However, a tiny dark or bright dot may appear on the screen. This is a common occurrence due to the production process, and it does not indicate a functional failure. ※ Bright spot: brightly lit dots, Dark spot: invisible or blurred point of text or objects, Blinking: flashing dots, Bright dot: glowing dots that are brighter than regular images
<p>I hear a noise.</p>	<ul style="list-style-type: none"> • Electrical noise: this is a small sound generated from the operation of the high-speed switching circuit that supplies current to the projector, and the noise may vary depending on the product. This noise is normal and does not affect the projector's functions. LG Electronics manages the manufacturing of projectors according to strict standards. A fixed level of noise does not indicate a problem. Please understand that this does not allow you to get an exchange or refund. • Fan sound: to maintain the temperature inside the projector at an appropriate level, the fan sound may increase or decrease depending on the ambient temperature.

CHECKING INFORMATION

Specifications

MODEL	HU915QE (HU915QE-GL) HU915QB (HU915QB-GL)	
Resolution (Pixel)	3840 (Horizontal) × 2160 (Vertical) ¹⁾	
Aspect ratio	16:9 (Horizontal:Vertical)	
Projection distance – Screen size	403 mm to 530 mm (15.8 inches to 20.8 inches) – 2286 mm to 3048 mm (90 inches to 120 inches)	
Ratio of upward projection	120 %	
Power consumption	350 W	
Power	AC 100 - 240 V~, 50/60 Hz, 3.5 A	
Audio Output	40 W	
Height	128 mm (5.0 inches) (without foot), 139 mm (5.4 inches) (with foot)	
Width	680 mm (26.7 inches)	
Depth	347 mm (13.6 inches)	
Weight	13.1 kg (28.8 lbs)	
USB Device	5 V, 0.5 A (Max.)	
Environment Condition	Temperature	
	Operation	0 °C to 40 °C (32 °F to 104 °F)
	Storage	-20 °C to 60 °C (-4 °F to 140 °F)
	Relative Humidity	
	Operation	0 % to 80 %
	Storage	0 % to 85 %

- Contents in this manual may be changed without prior notice due to upgrade of product functions.
- 1) 4K UHD resolution with 8.3 million discrete pixels projected by XPR (Expanded Pixel Resolution) video processing.

HDMI Supported mode

HDMI (DTV)

Resolution	Horizontal Frequency (kHz)	Vertical Frequency (Hz)
640 x 480	31.46	59.94
640 x 480	31.5	60
720 x 480	31.47	59.94
720 x 480	31.5	60
720 x 576	31.25	50
1280 x 720	44.96	59.94
1280 x 720	45	60
1280 x 720	37.5	50
1920 x 1080	28.12	50
1920 x 1080	33.72	59.94
1920 x 1080	33.75	60
1920 x 1080	26.97	23.97
1920 x 1080	27	24
1920 x 1080	33.71	29.97
1920 x 1080	33.75	30
1920 x 1080	56.25	50
1920 x 1080	67.43	59.94
1920 x 1080	67.5	60
1920 x 1080	112.5	100
1920 x 1080	134.86	119.88
1920 x 1080	135	120

Resolution	Horizontal Frequency (kHz)	Vertical Frequency (Hz)
3840 x 2160	53.95	23.98
3840 x 2160	54	24
3840 x 2160	56.25	25
3840 x 2160	61.43	29.97
3840 x 2160	67.5	30
3840 x 2160	112.5	50
3840 x 2160	134.86	59.94
3840 x 2160	135	60
4096 x 2160	53.95	23.98
4096 x 2160	54	24
4096 x 2160	56.25	25
4096 x 2160	61.43	29.97
4096 x 2160	67.5	30
4096 x 2160	112.5	50
4096 x 2160	134.86	59.94
4096 x 2160	135	60

HDMI (PC)

Resolution	Horizontal Frequency (kHz)	Vertical Frequency (Hz)
640 x 350	31.46	70.09
720 x 400	31.46	70.08
640 x 480	31.46	59.94
800 x 600	37.87	60.31
1024 x 768	48.36	60
1360 x 768	47.71	60.01
1152 x 864	54.34	60.05
1280 x 1024	63.98	60.02
1920 x 1080	67.5	60
1920 x 1080	134.86	119.88
1920 x 1080	135	120
3840 x 2160	53.95	23.98
3840 x 2160	54	24
3840 x 2160	56.25	25
3840 x 2160	61.43	29.97
3840 x 2160	67.5	30
3840 x 2160	112.5	50
3840 x 2160	134.86	59.94
3840 x 2160	135	60

Resolution	Horizontal Frequency (kHz)	Vertical Frequency (Hz)
4096 x 2160	53.95	23.98
4096 x 2160	54	24
4096 x 2160	56.25	25
4096 x 2160	61.43	29.97
4096 x 2160	67.5	30
4096 x 2160	112.5	50
4096 x 2160	134.86	59.94
4096 x 2160	135	60
2560 x 1440	88.78	59.95

- If an invalid signal is input into the projector, it will not be displayed properly on the screen or a message such as [No Signal] or [Invalid Format] will be displayed.
- The projector supports the DDC1/2B type as the Plug and Play function (Auto-recognition of PC monitor).
- 3840 x 2160 is recommended as the best picture quality in the PC mode.

Licenses

Supported licenses may differ by model. For more information about licenses, visit www.lg.com.



The terms HDMI, HDMI High-Definition Multimedia Interface, and the HDMI Logo are trademarks or registered trademarks of HDMI Licensing Administrator, Inc.

Manufactured under license from Dolby Laboratories. Dolby, Dolby Vision, Dolby Vision IQ, Dolby Audio, Dolby Atmos, and the double-D symbol are trademarks of Dolby Laboratories Licensing Corporation.

QUICKSET[®]



Open Source Software Notice Information

To obtain the source code that is contained in this product, under GPL, LGPL, MPL, and other open source licenses that have the obligation to disclose source code, and to access all referred license terms, copyright notices and other relevant documents, please visit <https://opensource.lge.com>.

LG Electronics will also provide open source code to you on CD-ROM for a charge covering the cost of performing such distribution (such as the cost of media, shipping, and handling) upon email request to opensource@lge.com.

This offer is valid to anyone in receipt of this information for a period of three years after our last shipment of this product.

Other specifications







As with any bright light source, do not stare into the beam, RG2 IEC 62471-5:2015.

Risk Group 2

CAUTION Possibly hazardous optical radiation emitted from this product. Do not stare at operating lamp. May be harmful to the eye.

This label is attached to the bottom of the product and language may differ.

Symbols

	Refers to alternating current (AC).
	Refers to direct current (DC).
	Refers to class II equipment.
	Refers to stand-by.
	Refers to "ON" (power).
	Refers to dangerous voltage.



ABOUT LG PROJECTOR

The images in this user manual are for illustration purposes only and may look different from the real product.

The contents of this user manual may be changed or added without prior notice to improve the quality of the product.

Your projector's OSD (On Screen Display) may differ slightly from that shown in this manual.

[]: the buttons and the text to be displayed on the projector screen.

CONTENTS

3	ABOUT LG PROJECTOR
11	HOW TO OPERATE THE PROJECTOR
22	APPS AND CONTENT
26	CONNECT OTHER DEVICES
43	MAKING THE MOST OF SMART PROJECTOR
48	SETTINGS
89	TROUBLESHOOTING
103	BEING AWARE OF THE INFORMATION

ABOUT LG PROJECTOR

Home Tutorial

Using the Home feature of the LG Projector

You can open the Home screen by pressing the  button on your remote control.

You can use more features by scrolling the  **Wheel (OK)** button on the Magic Lighting Remote.

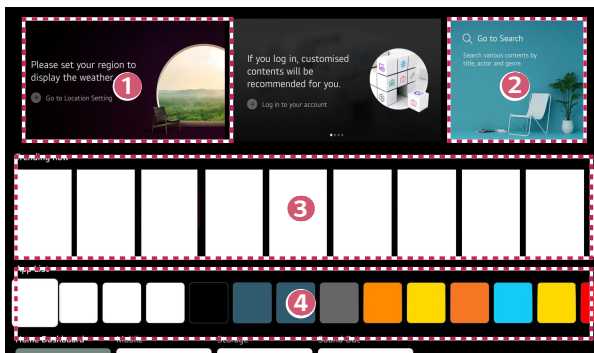

You can open apps and content or use various features of the smart projector.



- 1 You can check weather information and useful projector features.
- 2 Launch [Search].
For details, please refer to "Search Content".





- 3 You can get recommendations from various contents.
- You must log in to your LG account to get personalized content recommendations.
 - You must connect to the network to use the recommendation feature.

- 4 You can run, move, and delete the apps installed on your projector.

- [App List] and [Top Picks For You] are automatically shown on the screen each time the projector is turned on. To disable this feature, set [Home Auto Launch] of  (**Q. Settings**) →  → [General] → [System] → [Additional Settings] → [Home Settings] to [Off].
- The availability of and access to contents and services in LGE device are subject to change at any time without prior notice.
- Available features vary depending on the region or service.

Manage LG Projector Home

You can view a list of all apps installed on your projector, change their positions, or delete them.

- 1** Select the app you want to edit, and then press and hold the  **Wheel (OK)** button on the remote control to enter the [Edit App list] mode.
Alternatively, you can press the [Edit App list] button located at the end of the [App List].
- 2** Move to the desired position and press the  **Wheel (OK)** button to change the position of the app.
To delete an app, select the  icon above the app.
 - You can also move apps with the  /  buttons on your remote control.
- 3** After editing is complete, click [Close] at the bottom of the screen to exit the Edit App mode.
 - The default projector app cannot be deleted.

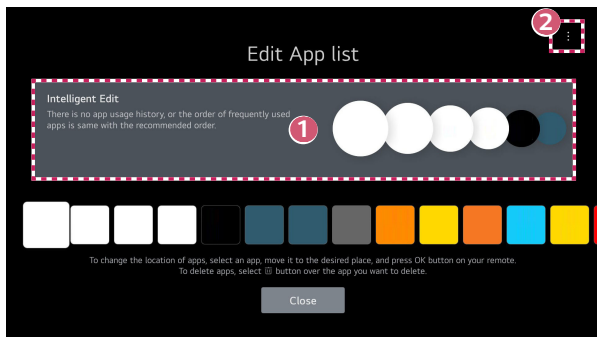

- 1 The apps will be automatically arranged according to their frequency of use.
- 2 [Reset App Order]: Resets the order of items in the app list.
[Delete Usage Data]: It resets the content view history and the app usage history. If you reset them, it takes some time to receive recommendations for contents again.

Network Setting



Network Setting

If you configure settings for the network, you can use various services such as online contents and applications.



Setting a Wired Network

- 1 Connect the LAN port of the projector and the router using a LAN cable. The router should be connected to the Internet beforehand.
 - If the router supports DHCP, the projector is automatically connected to the network when you connect the projector to the network with a LAN cable.

If the Network Is Not Automatically Connected

- 2 Press the  (**Q. Settings**) button on the remote control.
- 3 Select  → [General] → [Network] → [Wired Connection (Ethernet)].

Setting a Wireless Network

- 1 Turn on the power of the router connected to the Internet.
- 2 Press the  (**Q. Settings**) button on the remote control.
- 3 Select  → [General] → [Network] → [Wi-Fi Connection].
- 4 When the network search is complete, the list of networks available for connection is shown.
- 5 Select a network to connect.
If your Wireless Router is password protected, enter the password configured for the router.

Cautions for Network Setup

- Use standard LAN cable (connect to Cat7 or higher with RJ45 connector, 10 Base-T, or 100 Base TX LAN port).
- Resetting the router may fix some network connection problems. Turn the power OFF, disconnect and reconnect it, and then turn the power on to solve the problem.
- LG Electronics is not responsible for network connectivity or operation failure due to problems such as equipment failure or disconnected lines.
- The network connection may not work properly because of network settings or the Internet service provider.
- DSL service must use a DSL modem; and cable service must use a cable modem. Since only a limited number of network connections may be available, projector network setting may not be used depending on the contract with Internet service provider. (If the contract does not allow more than one device per line, only the already-connected PC may be used.)
- A wireless network can experience interference from other devices that use the 2.4 GHz frequency (wireless phone, Bluetooth device, or microwave oven). Although interference can also happen when using the 5 GHz frequency, it is less likely to occur.
- The wireless environment can make wireless network service run slowly.
- Using several wireless devices at the same time can slow your network.
- The access point device must support wireless connections and wireless connection feature must be enabled on the device to have AP (access point) connection. Contact the service provider for availability of wireless connections on the access point.
- Check SSID and security settings of the AP. Refer to the appropriate documentation for SSID and security settings of the AP.
- Invalid settings of network devices (wired/wireless line sharer, hub) can cause the projector to operate slowly or not operate properly. Install the devices correctly according to the appropriate manual and network.
- The connection method may differ depending on the AP manufacturer.
- To troubleshoot problems with this feature, refer to "TROUBLESHOOTING".



Managing your LG Account

LG Membership

You can receive customized recommendations and utilize various app services with your LG Account.

In LG Account, you can sign up for LG membership with an email address.



Alternatively, you can create and log in to an LG membership using the ID and password of an external service account.

- 1** Select  (**Q. Settings**) →  → [General] → [System] → [LG Account].
- 2** Choose one from the three options, Sign in with the [Sign in with the Web Browser]/[Sign in with the Projector remote], and sign up for LG membership.
- 3** Agree to the User Agreements and enter the information required to sign up.
 - Required information may vary depending upon the country.
- 4** A verification link will be sent to the email address you entered when you signed up. Please complete email verification within the validity period.
- 5** Once your email address is verified, you can log in with your credentials.
 - This feature may not be available in some countries.
 - Age restrictions may apply for signing up.
 - To troubleshoot problems with this feature, refer to "TROUBLESHOOTING".

Managing your LG Account

You can view basic information about the logged in account.



You can change your password or edit your account information.

- 1** Press the  (**Q. Settings**) button on the remote control.
- 2** Select  → [General] → [System] → [LG Account] to log in.

HOW TO OPERATE THE PROJECTOR

Using Projector Functions through Speech

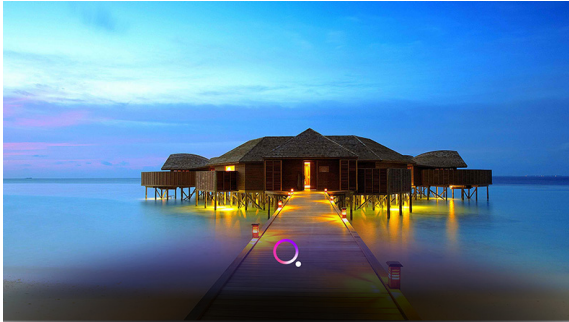

You can easily and quickly access the projector's various functions through speech recognition.

- 1** Press and hold the  (**Voice recognition**) button on the remote control and speak out the function you want to launch or the keyword you want to use for your search.
- 2** Once you release the  (**Voice recognition**) button after your speech input, the corresponding function is launched.



- Some models may not be supported.
- Your [Location] must correspond to the language for exact search results. Some function may not be available if your location settings and language settings are different.
- You can change the language in (**Q. Settings**) → → [General] → [System] → [Language] → [Menu Language].
- The languages available for voice recognition features may be changed in accordance with service operation policy.
- Details of service may vary by model.
- Please note that AI service may be changed, removed or terminated, without notice, by LGE or its third party providers.
- You can check what features are available for voice recognition in (**Q. Settings**) → → [General] → [AI Service] → [Voice Recognition Help].
- You can set voice recognition related features in (**Q. Settings**) → → [General] → [AI Service] → [Voice Recognition Settings].

Cautions for Speech Recognition

- Voice recognition requires a Magic Lighting Remote, which may not be supported by certain models.
- To use all speech recognition features, you need to set your regions, etc. Otherwise, you cannot use some features.
- You must have a network connection to use the speech recognition feature.
- If you have a network connection, you need to accept the terms and conditions to use speech recognition.
- To control the set-top box connected to the projector with the voice recognition, you need to set the universal remote control in  (**Q. Settings**) →  → [General] → [Devices] → [External Devices] → [Universal Control Settings].
- It is recommended to point the Magic Lighting Remote toward the set top box after the voice input.
- The rate of speech recognition may vary depending on the characteristics of the user (voice volume, pronunciation, accent, and talking speed) and the surroundings (noise and projector volume).
- To achieve accurate recognition of your speech, you must pronounce words in a slow and accurate manner at an appropriate voice volume at a distance of about 10 cm (3.9 inches) away from the Magic Lighting Remote's microphone.
- If your speech is not recognized properly, speech recognition may operate differently than you originally intended.

To View More Features of the Remote Control

You can control more features or external devices connected to your projector by using the buttons displayed on your projector screen.

- 1 Press the **•••** button on the remote control.
- 2 Using the remote control, select your desired button on [More Actions] displayed on your projector screen.



- 1 You can set up the universal remote control.
 - You need Magic Lighting Remote to use universal remote control function. (The provided remote control differ depending upon model.)
 - 2 External input information is displayed on the screen.
 - 3 When the projector malfunctions, you can get help to solve the problem.
- The types of buttons appearing on the [More Actions] vary, depending on the region and the type of connected device.
 - The configurable items differ depending upon model.

Universal Remote Control

Automatically Setting the Universal Remote Control

When you set up the universal remote control, you can control the peripherals (Blu-ray / DVD player, home theater, set-top box, etc.) with the Magic Lighting Remote rather than using their dedicated remote controls.

Connect the devices to be set to the projector's HDMI input, and turn the power of the device on.

The projector will scan the connected device to automatically set the universal remote control without manual setting.

- After setting the universal remote control, you may need to do some additional user settings.
- It may take several seconds to complete the settings for the universal remote control.
- In some models, you can set the universal remote control only after converting to an input of a connected device.
- Depending on the connected device, the automatic setting feature for universal remote control (automatic device connection) may not be supported.

Manually Setting the Universal Remote Control

If the universal remote control is not set up automatically, you can set it up manually.

1 Select  (**Q. Settings**) →  → [General] → [Devices] → [External Devices] → [Universal Control Settings].

2 Select the type of the device you want to set.

3 Complete the settings for the universal remote control according to the guidance on the screen.

You can change or cancel the universal remote control settings.

- This feature can only be used with the Magic Lighting Remote. (The provided remote control differ depending upon model.)
- Some models may not be supported.
- When changing the settings, check that the device to be changed is turned on.
- To set up the universal remote control with the latest information, connect to a network and agree to the User Agreements.
- The manual setting feature for universal remote control is not supported for a game console.
- Some buttons may not work depending upon the model of the external device.
- Point the Magic Lighting Remote at the device you want to control. Make sure that there are no objects in front of the device to ensure that the remote control signal is well received.

Launching Apps through [Quick Access]

Using apps quickly and easily with [Quick Access]

Press and hold a number button on the remote control to open an app or to activate an external input registered to the button.

Setting the [Quick Access]

- 1** Launch the app or input you wish to assign.
- 2** Press and hold the number button (1-8) you want to register.
No. 9 is fixed to [Quick Help].
- 3** When the registration pop-up window appears, select [Yes].
 - If you press and hold a number button that has already been registered, the registered function will be performed.
 - To see the items that can be registered, select a number that has not been registered in the [Edit Quick Access] mode.
 - If you are in a mode where [Quick Access] cannot run, no action will be performed.
 - If you delete a registered app, [Quick Access] will be deregistered as well.

Checking and editing [Quick Access]



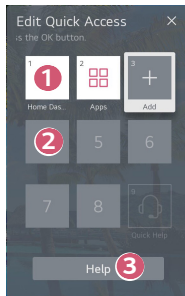

Press and hold the number **0** button on the remote control.
The [Quick Access] edit screen appears.



- 1** Selecting a number that has already been registered allows deregistering it.
- 2** When you select a number that has not been registered, items that can be registered will be shown.
 - An item that has been registered to a different number is indicated with a check mark.
- 3** You can view a brief instruction for this function.

Using SIMPLINK

With a single remote control, you can easily manage various devices such as a soundbar or set-top box connected to a projector with HDMI.

- Up to three devices can be connected and used simultaneously.
- 1** Connect the SIMPLINK HDMI Output port to the projector's HDMI IN port with an HDMI[®] cable.
- 2** Select  (**Q. Settings**) →  → [General] → [Devices] → [HDMI Settings].
- 3** Set [SIMPLINK (HDMI-CEC)] to [On].
- 4** Turn on the connected device. When the projector automatically connects to the device, the input will switch. If the device is not automatically connected to the projector, click the  button.
- This feature works only with devices with the  SIMPLINK logo. Check for the SIMPLINK logo on the external device. There may be a problem using the device if the device does not meet the required specifications.
- A high-speed HDMI[®] cable with CEC (Consumer Electronics Control) function is required to use SIMPLINK. Pin 13 of the high-speed HDMI[®] cable is used for data transfer between devices.
- If you want to output sound to the external audio equipment connected through the HDMI[®] cable, set [SIMPLINK (HDMI-CEC)] to [On].

Supported SIMPLINK Functions

- **Instant Play**

When you start a multimedia device, you can immediately watch content from the device on the projector without having to control anything.

- **Controlling devices with the projector remote control**

Enables the user to control multimedia devices with the projector remote control to watch content.

- The menu of the multimedia device can be operated with the arrow keys on the remote control.

- **Main Power Off**

Turning off the projector will also turn off the devices connected through SIMPLINK.

- This feature is only available in certain devices.

- **Main Power On**

Turning on a SIMPLINK device will also turn on the projector.

- Some models may not be supported.

Connecting an Input Device to USB

Using a USB Wired/Wireless Mouse

Connect your mouse to the USB port. Use the mouse to move the pointer on the projector screen and select the menu you want.

- The right button and the special buttons on the mouse do not work.
- When using a wireless USB mouse, the connection can be lost or slowed, depending on the distance between the projector and mouse and the wireless environment.

Using a USB Wired/Wireless Keyboard

Connect your keyboard to the USB port. You can enter text with the connected keyboard device.

- It is not possible to enter text on some screens.
- It is recommended that you use a product that has been tested for compatibility with LG projectors.
LOGITECH K360, LOGITECH K400, LOGITECH K750, LG Electronics MKS-1200
- You can change the input language by pressing the language switch key or the right Alt key. It can also be changed by pressing the Ctrl key and the Space key at same time.
- When using a wireless USB keyboard, the connection can be lost or slowed, depending on the distance between the projector and keyboard and the wireless environment.
- To enter text in the text field, use the on-screen keyboard on your projector screen or a USB keyboard.

Using a Gamepad

Connect your gamepad to the USB port on the projector if the game requires a gamepad.

- It is recommended that you use a gamepad that has been tested for compatibility with LG projectors.
PS Dual Shock4 ver:1 & ver:2, MICROSOFT Xbox 360 Controller (cable), NVIDIA Shield Controller, LOGITECH F310, LOGITECH F510, LOGITECH F710, LOGITECH Rumblepad 2, LOGITECH Cordless Rumblepad 2, LOGITECH Dual Action Gamepad, SONY Playstation(R)3 Controller

APPS AND CONTENT



Installing Apps

You can install apps in a variety of categories such as games, education, and news and conveniently use them on your projectors.

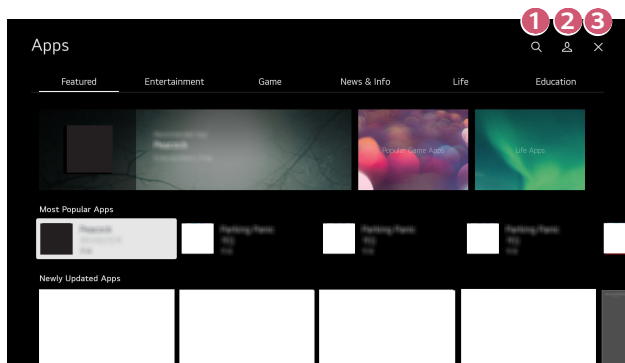
- 1** Press the  button on the remote control.
- 2** Launch [Apps].
- 3** Select a category or press the Search button to search for an app.
- 4** Select an app to install.
- 5** Read the details of the app and then press [Install].
- 6** When the installation is complete, you can run the app immediately.



- 1 Searches for content.
For details, please refer to "Search Content".
- 2 You can log in with your LG account and manage apps.
- 3 Closes [Apps].

- In order to install apps, you must be logged in.
- Available categories may vary depending on the country or service status.
- If the storage on your projector is insufficient, you can install the apps by connecting an external memory device.
- Some USB storage devices may not be supported or may not work properly.
- USB drivers containing apps from other LG TVs or LG Projectors may not be used.
- Exercise caution when in used by children. Children may have access to inappropriate online content through this product. You can block inappropriate online content by restricting access to some apps.
 - Configure the settings in  (**Q. Settings**) →  → [General] → [System] → [Safety] → [Application Locks].

Content Recommendation

If you are watching the projector using a set-top box, you must complete the setup of the universal remote control to use the recommendation feature normally.

For details, please refer to "Universal Remote Control".

1 Press the  (**Voice recognition**) button on the Magic Lighting Remote. The Content Recommendation screen appears.

- When using a standard remote control, press the  button on it.

2 You can view more content by pressing the  icon on the screen.

- Some models may not be supported.
- You must connect to the network to use the recommendation feature.
- The supported services vary depending on countries, so the recommendations may be provided differently.
- The list of the recommendations may be less relevant or irrelevant, depending on the information of the program you are watching.

Search Content

Searches for content by title, actor/actress, and genre.

- 1 Press the  button on the remote control.
- 2 Launch [Search].
- 3 Search for a variety of content and information by typing in your desired search terms.

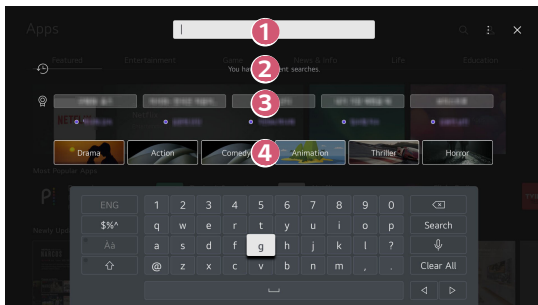



- 1 Enter your desired search term.
 - 2 Shows recent searches.
 - 3 You can select one from the suggested keywords and proceed to search.
 - 4 Provides a list of content for the selected genre.
- You must connect to the network to use the search feature.
 - Search results may vary depending on the region, network settings, and whether you have agreed to the terms and conditions.

CONNECT OTHER DEVICES

Using [Home Dashboard]

You can select or control a device (mobile, external device, etc.) connected to the projector.

- Press the  button on the remote control and select [Home Dashboard].
- You can also press and hold the  button on the remote control.

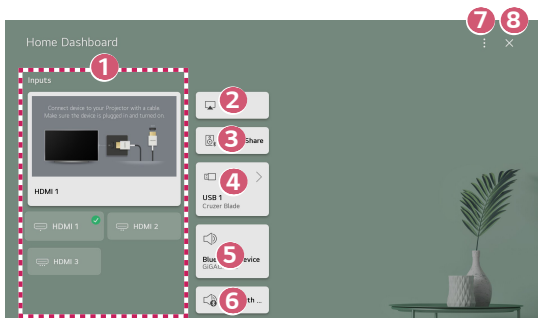

- 1 You can check and select the external device connected through the external input port or network.
- 2 Use AirPlay/HomeKit to control your projector and watch content from your iPad or Mac on the projector screen.
 - The availability of and access to Contents and Services in LGE Device are subject to change at any time without prior notice.

- 3 You can play sound from a smart device connected via Bluetooth. For detailed instructions, refer to "Playing Sound from a Smart Device through the projector's Speakers".
 - 4 It can only be selected if you have connected a USB storage device or a media server.
 - 5 The currently selected output speaker is displayed, and you can navigate to the output speaker settings screen.
 - 6 You can view the list of connected Bluetooth devices and select one.
 - 7 [Edit]: You can edit the name of the device connected to [Edit Inputs] or configure the related settings.
[Universal Control Settings]: Move to the [Universal Control Settings] app.
 - 8 Exit the [Home Dashboard].
- The configurable items differ depending upon model.

To see the Smart Device's screen on the projector

To see the Mobile Device's screen on the projector

- 1** Enable Screen Share mode on the mobile device.
- 2** Your projector will be displayed in the list of available devices.
- 3** Select your projector and request connection.
- 4** Select accept in the connection request popup window.
- 5** After the connection is established, the projector will display the screen of the connected device.
 - For a reliable connection always keep the connected device to your projector updated to the latest OS version.
 - A non-LGE device might not connect even when it is detected.
 - Connect the device to a 5 GHz router because the performance may be affected by your wireless environment.
 - The response rate may vary, depending upon the user's environment.
 - It differs among devices. For more information on the device you want to connect to, refer to its user guide.
 - If connection fails repeatedly, turn off the projector and the device you want to connect to, then turn them back on and try again.

Playing Sound from a Smart Device through the projector's Speakers

Connect a smart device to the projector via Bluetooth to play sound from the smart device through the projector's speakers.



- 1** Turn the smart device's Bluetooth on, then select the projector from the list of devices.
- 2** The projector will be connected to the smart device.
 - If the output speaker is set to [Bluetooth Device] or has a setup history, the projector may not be detected in the list of smart devices.
 - If the output speaker is set to [Bluetooth Device], press and hold the  button on the remote control to open [Home Dashboard], and then select [Sound Share] in the mobile area to connect.

Connecting USB

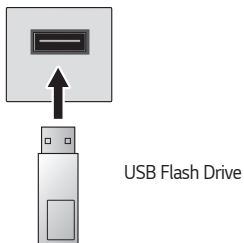
Connect a USB storage device (USB HDD, USB Flash Drive) to the USB port on the projector to easily enjoy the content files stored on the USB storage device on your projector.



Tips for Using a USB storage device

- A USB storage device that has a built-in automatic recognition program or uses its own driver might not be recognizable.
- Some USB storage devices may not be supported or may not work properly.
- If you use a USB extension cable, the USB storage device may not be recognized or may not work properly.
- Please use only USB storage devices formatted with the FAT32 or NTFS file system provided by Windows OS.
- It is recommended that you use an external USB HDD with a rated voltage of 5 V or less and a rated current of 500 mA or less. If you use a device requiring a higher voltage/current than the rated voltage/current, it may not operate properly due to lack of current.
- For USB hubs and USB storage devices, it is recommended to use a type that supplies power by connecting the AC adapter to a power outlet.
- It is recommended that you use a USB stick of 32 GB or less or a USB HDD of 2 TB or less.
- If a USB HDD with power-saving function does not work, turn the hard drive off and on again to make it work properly. See the owner's manual for the USB HDD for more information.
- Data on a USB storage device may be damaged, so it is recommended that you back up any important files. Users are responsible for data management. The manufacturer bears no responsibility.
- Press the  button on the remote control. To remove the USB storage device, press the [Eject] button, which appears at the top when you focus on the USB storage device you want to remove.
If you disconnect the USB storage device without selecting [Eject], an error may occur in your projector or storage device.
- When you connect a USB storage device of a file system not supported by the projector to the USB input port, the format message appears. To use the connected USB storage device, you should format the device first. After format, all the data of USB storage device will be deleted and formatted as NTFS or FAT32 file system.
- Press and hold the  button on your remote control. Select the connected USB from [Home Dashboard] and select the [Format] button to format the USB storage device.
- When connecting a USB storage device, a random file/folder can be created to provide Smart projector services such as the saving and retrieving of thumbnail images.

Using the [Media Player]

You can search and view photos or play videos and songs with the [Media Player] app.

- 1 Press the  button on the remote control.
- 2 Run the [Media Player] app.
- 3 Select a device to use from the device list.
- 4 Select the content to play.

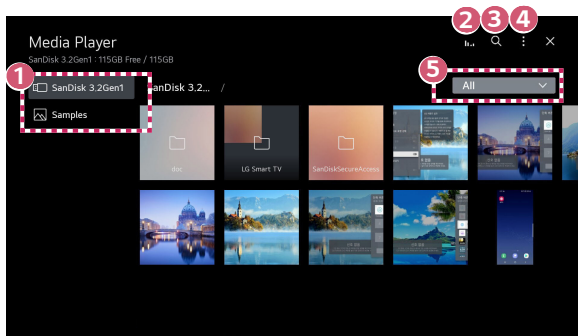

- 1 You can select a device connected to your projector.
 - 2 Displayed only when music is playing. Press the **|||** to access the Play Music screen.
 - 3 Launch [Search].
 - 4 [View Type]: Selects a content display mode.
[Sort]: Select the option to sort content.
[Group]: If you filter by [Music], you can group content into categories such as [Artist] and [Album].
[Selection Play]: You can select and play multiple pieces of content.
[Delete]: You can select and delete multiple pieces of content.
 - 5 Shows the content of the selected type only.
- You cannot delete files that are shared from other devices.
 - Different settings items are available depending on the filtering or model you selected.
 - Certain content may not be displayed on the list if the number of all content exceeds 40,000.

Viewing Photos

You can select a photo from the [Media Player] app and view the photo.

You can use more features by pressing the ▾ button on the remote control while viewing a photo.



- 1 Shows the previous content.
- 2 Starts the slide show.
- 3 Shows the next content.
- 4 Rotates photos.
- 5 You can zoom the photos in/out.
- 6 360-degree photos can be viewed in 360 degrees.
 - Using the 360° VR Play on a normal photo may distort the image.
 - Some models may not be supported.
- 7 Plays a music file selected from the storage device as background music.
- 8 You can set the size of a photo or change the speed and effect of a slide show.
 - Some models may not be supported.

Playing Videos

You can select a video from the [Media Player] app and play the video.

Pressing the ◀/▶ buttons on the remote control allows you to skip backward/forward 10 seconds.

You can access more features by pressing the ▾ button on the remote control while playing a video.

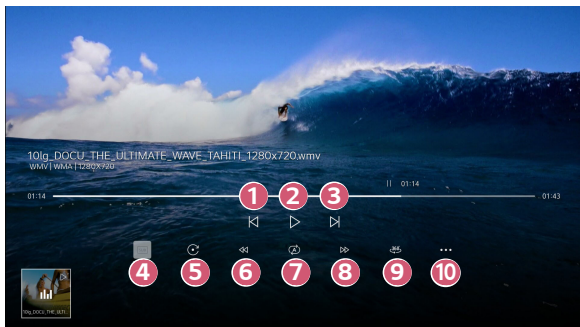

- 1 Shows the previous video.
- 2 Plays or pauses the video.
- 3 Shows the next video.
- 4 You can change subtitle settings.
- 5 Rotates videos.
- 6 Fast-rewinds the video at higher speeds.
- 7 You can do the settings related to play on repeat of the video.
- 8 Fast-forwards the video at higher speeds.
- 9 360-degree videos can be viewed in 360 degrees.
 - Using the 360° VR Play on a normal video may distort the videos.
 - Some models may not be supported.
- 10 [Resume Play]: You can set continue watching to resume playing from the last viewed scene.
[Play Speed]: Sets the playback speed.
[Audio Track]: You can set audio tracks.

Listening to Music

You can select a song from the [Media Player] app and play the song.

You can use more features by pressing the ▾ button on the remote control while playing a song.

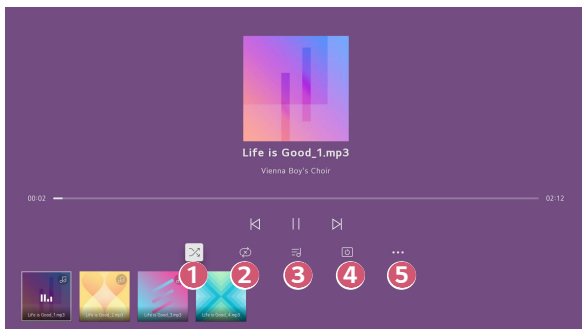

- 1 You can set the random play mode.
- 2 You can set the repeat play mode.
- 3 Lyrics are available for music files that provide them.
In some music files, you can choose a lyric section and move the playback position.
 - The lyrics feature is only supported on some devices.
 - The lyrics may not be displayed in sync depending on the lyrics data in the music file.
- 4 You can listen to music with the screen turned off.
- 5 You can set the lyric speed.
 - This feature may not be supported depending on the music.

View Computer Files

Watch content saved in your PC on the Projector

You can enjoy videos/music/photos stored on your PC on the Projector when these devices are connected to the same network.

Browse the content on your PC to watch on Projector (Windows 10)

- 1** Connect you projector and PC to the same network.
 - 2** Right-click the file you want to play and select "Cast to Device".
 - 3** Select the name of the Projector you want to watch from the displayed list, and playback will start on that Projector.
- Even when multiple projectors or devices are connected, the selected file is played through only one device. The playback rate may vary depending on the network connection.
 - To play on other operating systems or devices, refer to the manual of the operating system/device.

Browse and watch the content stored on the PC using the Projector (Windows 10)

- 1** Connect you projector and PC to the same network.
 - 2** Open the “Start” menu on your PC screen, search for “media streaming options” and then select the result that appears.
 - 3** Select the “Turn on media streaming” button in the window that opens.
 - 4** Allow all of the “media streaming options”.
 - 5** Select “OK” to save the settings.
 - 6** Select the connected PC in the [Home Dashboard] app on the Projector, and then select and play the file you want.
- To play on other operating systems or devices, refer to the manual of the operating system/device.

Matters that require special attention during Content Share

- Check your network settings if the Content Share option does not work properly.
- May not work properly on a wireless network. It is recommended that you connect to a wired network.
- May not work properly depending on the network environment.
- If multiple display devices are connected to one device, the content may not be played properly depending on server performance.
- To watch the 1080p video through Content Share function, a router that uses 5 GHz frequency is required. If a 2.4 GHz router is used, the video may not play properly.
- The Content Share function may not be supported for a router that does not support multi-cast. For more information, refer to the user guide that came with your router or contact the manufacturer.
- Captions are only supported on some connected devices.
- If you have added a caption file afterward, disable the shared folder on the PC and then enable it again.
- The DRM files in the connected device will not play.
- Even for the file format supported by the projector, the supported file format may differ depending on the connected device environment.
- If there are too many folders or files in a folder, it may not work properly
- The information on the file imported from the connected device may not be displayed correctly.
- Depending upon the encoding, some streams may not play in Content Sharing mode.

To See the PC Screen on the Projector

To see the PC screen on the projector

Connect wireless

- 1** Enable Screen Share mode on the PC. Your projector will be displayed in the list of available devices.
- 2** Select your projector and request connection.
- 3** After the connection is established, the projector will display the screen of the connected device.
 - For a reliable connection always keep the connected device to your projector updated to the latest OS version.
 - It is recommended that you use this function at close range.
 - Start Screen Share faster by having your mobile device or PC connected to the same network as the projector.
 - Though it can be connected without a wireless router, connecting your device to a 5 GHz router is recommended because the performance can be affected by the surrounding wireless environment.
 - The response rate may vary, depending upon the user's environment.
 - It's different from Windows version. For more information on the device you want to connect to, refer to its user guide.
 - If connection fails repeatedly, turn off the projector and the device you want to connect to, then turn them back on and try again.

Connect wired

- 1** Connect the PC with projector by HDMI® cable.
- 2** In  → [Home Dashboard], change the input to the terminal to which the HDMI cable is connected.
- 3** After the connection is established, the projector will display the screen of the connected PC.
 - If there is a problem with your connection, refer to "Troubleshooting PC Connection Issues".

MAKING THE MOST OF SMART PROJECTOR

Using the [Web Browser]

Using the [Web Browser]



You can enter the website when you input the web address on the URL bar.

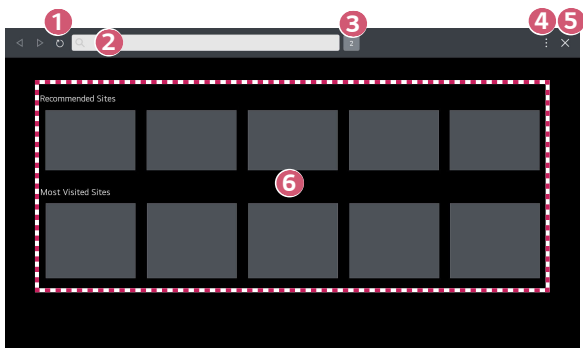

If you input the search word, it will find the information about search word base on the search engine.

- 1 Press the  button on the remote control.
- 2 Launch the [Web Browser] application.



- 1 You can refresh the web page you are viewing.
- 2 You can type in a web address to navigate to a specific website or enter a search term directly.
- 3 You can view the tabs that are currently open.

- 4** You can zoom in or out on the screen while browsing the website.
[Block Ads]: You can block ads within the web page you are viewing.
However, this button is displayed only when  → [Settings] → [Use Block Ads] is set to [On].
[Projector View]: Split the screen to display the projector screen. You can browse web pages while watching projector.
[Add to bookmarks]: You can add the website you are currently viewing to your Favorites.
[History]: You can view and delete the website visit history.
[Bookmarks]: You can view and delete the list of websites you have added to your Favorites.
[Settings]: You can change the web browser settings.
- 5** Exit the [Web Browser].
- 6** The new tab screen shows a list of [Recommended Sites] and [Most Visited Sites].
If you do not want to display [Recommended Sites], set the  → [Settings] → [Show Recommended Sites] function to [Off].
[Recommended Sites] may vary by country and is only available in certain countries.

- The [Web Browser] app on your projector is a browser for projector, so it may work differently than the browser for your PC.
 - Some of the content may not play properly.
 - Flash Plug-in is not supported, and only HTML5 media is supported.
 - Plug-in installation is not supported.
 - Media in formats other than JPEG / PNG / GIF may not be played.
 - Apps may be forced to shut down if the projector runs out of memory.
 - The fonts provided on the projector are used. Depending on the content, characters may look different from PC or mobile browsers.
 - File and font downloads are not supported.
 - Caution is required because malicious or phishing sites are not automatically blocked.
 - Some features may not be supported temporarily due to external factors of the web browser.
- The website can be accessed through the projector's [Web Browser] app, so care needs to be taken about children's access to harmful online contents. You can lock the [Web Browser] app to prevent access to harmful online contents.
Configure the settings in  (**Q. Settings**) →  → [General] → [System] → [Safety] → [Application Locks].
- If you experience problems while using Web Browser, refer to Troubleshooting.

Changing Web Browser Settings

Select  → [Settings] at the top of the [Web Browser] app.

- [On Startup]
You can choose the page that appears when you start the [Web Browser] app.
- [Search Engines]
You can select a search engine to search for when entering a keyword in the address bar.
 - Search engine settings may be subject to change without notice based on the supplier's circumstances.
- [Show Recommended Sites]
You can set whether or not to display a list of [Recommended Sites] on the new tab screen.
- [Always Show Address Bar]
When set to [On], the address bar and menu bar area at the top will always be displayed.
- [Private Browsing]
If set to [On], a history of website visits will not be stored.
- [Site Filtering]
You can register websites to block or allow.
[Approved Sites]: You can configure the settings to open the previously registered web pages only.
[Blocked Sites]: You can configure the settings to block specific websites.
 - To use the [Site Filtering] function, you should enter the projector password.
- [Pop-up Blocker]
Blocks pop-ups that are automatically displayed by web pages.
- [Do Not Track]
You can request to not leave a history of your visit on the website. The operation may vary depending on the policy of the website.
- [Adaptive Streaming using JavaScript]
The media streaming technology using JavaScript allows you to view video with optimized resolution.
If this is set to [Off], the resolution of the videos played in [Web Browser] is limited to 720p.

- [Cookies Settings]
Enables the website to store and use cookie data.
- [Use Block Ads]
When set to [On], a button to turn [Use Block Ads] on or off appears when clicking the  icon at the top of [Web Browser]. Turning on the [Use Block Ads] feature speeds up page loading by blocking ads included in the website.
- [Automatic Web Browser Issue Report]
When it is set to [On], if a failure (malfunction, media playback failure, page loading failure, abnormal shutdown, delay in response due to insufficient memory, etc.) occurs while using the web browser, the relevant information will be automatically sent to the web browser development team at the LG Electronics headquarters (Korea). The submitted information will only be used to improve the Web Browser performance.
- [Clear Browsing Data]
[Clear Cookies]: Deletes cookie data. When deleted, you are logged out of most sites.
[Clear All Browsing Data]: Deletes all browsing history, including cookies.

SETTINGS

The configurable items differ depending upon model.

Quick Settings

Quick Settings

Displays a set of light-weight controls quickly and simply such as [Picture Mode], [Sound Out], [Sleep Timer] and so on.



Press the  (**Q. Settings**) button on the remote control.



- 1 You can set the [Picture Mode].
 - 2 You can choose the [Sound Out].
 - 3 Move to the [Game Optimizer] screen.
 - 4 You can set the [Sleep Timer].
 - 5 Move to the [Network] screen.
 - 6 You can set the [PJT Mode].
You can set more options.
 - 7
 - You can also long-press  (**Q. Settings**) button of the remote control to run the All settings directly.
 - 8 You can add/delete the quick setting items or change their order.
- After entering each item, press and hold the **Wheel (OK)** button on the remote control to go to the corresponding menu.

[Picture]

Selecting Picture Mode

 (Q. Settings) →  → [Picture] → [Select Mode]

Select the picture mode that is best suited to your viewing environment, preferences or video type.

Select a picture mode. By adjusting and setting each item in more detail based on the mode, your video is better optimized for its characteristics.

- The configurable items differ depending upon model.
- Depending upon the input signal, the available picture modes may be different.
- When watching online service content, the Picture Mode may be changed to match the content being shown.
- When changing [Select Mode], the aperture of the lens may move and make a sound, which is a normal operation.



When You Use Normal Signals

- [Vivid]
Sharpens the image by increasing the contrast, brightness and sharpness.
- [Standard]
Displays the picture with normal contrast, brightness, and sharpness levels.
- [Cinema]
Optimizes the screen for movies.
- [Sports]/[Soccer]/[Cricket]
Optimizes the screen for sports games. Sharpens the image of rapid movements such as kicking or throwing a ball.
 - The name of the sport may differ depending on region.
- [Game Optimizer]
Optimizes the screen for gameplay.
- [FILMMAKER MODE]
Provides optimized Cinema Picture quality certified by UHD Alliance, the standard setting body for UHD-related technologies.
 - To auto-switch to [FILMMAKER MODE] when a signal that can be operated with this mode is entered, set [FILMMAKER MODE Auto Change] to [On].
- [Brightest]
It displays the maximum screen brightness under appropriate image conditions.
- [Expert (Bright space, daytime)]/[Expert (Dark space, night)]
This mode is suitable for movies, etc. viewed in a dark environment.
[Expert (Dark space, night)] has lower color temperature than [Expert (Bright space, daytime)]. Select a mode that is suitable for the movie you are watching.

When You Use the HDR

- [Vivid]
Sharpens the image by increasing the contrast, brightness and sharpness.
- [Standard]
In a normal viewing environment, it opens a screen that can properly show the expressiveness and brightness of HDR.
- [Cinema Home]
The screen appears brighter and clearer than that of the [Cinema] screen.
- [Cinema]
Suitable picture for HDR video signal.
- [Game Optimizer]
Optimizes the screen for gameplay.
- [FILMMAKER MODE]
Provides optimized Cinema Picture quality certified by UHD Alliance, the standard setting body for UHD-related technologies.
 - To auto-switch to [FILMMAKER MODE] when a signal that can be operated with this mode is entered, set [FILMMAKER MODE Auto Change] to [On].
- [Brightest]
It displays the maximum screen brightness under appropriate image conditions.
- If an HDR video signal is input to the models that do not support the HDR technology, normal signal picture mode options will be made available.
- Depending upon the input signal, the available picture modes may be different.
- When watching online service content, the Picture Mode may be changed to match the content being shown.
- [Select Mode] changes may modify [Energy Saving] settings and it can affect energy consumption. You can change the settings in [Support] → [Energy Saving].

Setting the Screen Size

 (Q. Settings) →  → [Picture] → [Aspect Ratio] → [User Selection]

You can change the screen size according to the type of content you are watching.

- [16:9]
Displays an aspect ratio of 16:9.
- [Original]
The optimal screen ratio changes depending on the input image signal.
- [4:3]
Displays an aspect ratio of 4:3.
- [Vertical Zoom]
You can adjust the vertical dimension of the screen and align the screen vertically by using [Adjust Zoom Ratio] and [Adjust Screen Position].
- [4-Way Zoom]
You can adjust the horizontal/vertical/diagonal dimensions of the screen and align the screen horizontally/vertically by using [Adjust Zoom Ratio] and [Adjust Screen Position].
- The configurable items differ depending upon model.
- The picture may get distorted while zooming in or out.
- Selecting a different screen size from the original size may cause the image to look different.
- Depending on the combination of picture format and screen size, the edges may be hidden or shown in black, or both sides of the picture may flicker.
- Depending upon the input signal, the available screen sizes may be different.

View Screen with [Just Scan]



 (Q. Settings) →  → [Picture] → [Aspect Ratio] → [Just Scan]

If you turn this feature [On], you can view the content in the aspect ratio that is in content source. If the edge of the screen is not clean, please turn it [Off].

If set to [Auto], the feature switches between [On] or [Off] status depending on the information contained in the video signal.

- The items that can be selected may vary depending on the current input.

Adjusting the Brightness of a Picture

 (Q. Settings) →  → [Picture] → [Advanced Settings] → [Brightness]

You can adjust the brightness of the entire screen.

- [Adjust Contrast]

Adjusts the contrast of the bright and dark areas of the picture. The closer to 100, the higher the contrast.
- [Screen Brightness]

Adjusts the overall screen brightness. The closer to 100, the brighter the screen. You may use the [Screen Brightness] settings specifically to set the dark part of the image.
- [Auto Dynamic Contrast]

Corrects the difference between the bright and dark areas of the screen for optimal results depending on the brightness of the picture.
- [HDR Tone Mapping]



Suitable contrast settings based on image brightness of the HDR content.
- [Peak Brightness]

Adjust peak brightness for the brightest luminance.
- [Gamma(Adjust Brightness)]

Adjusts the medium brightness of the picture.
You can be selected from [1.9]/[2.2]/[2.4]/[BT.1886].
– [BT.1886] expresses the gradation in ITU-R BT.1886, which is an international standard.
- [Black Level]

Adjusts the darkness of the screen in order to display a perfect black. Select [Auto], [Limited], or [Full] to match the color range of the external input device.
– This feature can be used while watching content through an external input.
- Depending upon the input signal or the selected picture mode, the available options may differ.
- The configurable items differ depending upon model.

[Brightness Optimizer]

 (Q. Settings) →  → [Picture] → [Advanced Settings] → [Brightness Optimizer]

The [Brightness Optimizer] function adjusts the display for optimal resolution in accordance with the video and surrounding light conditions. Use [Iris Mode] to optimize the projector brightness according to the surrounding light conditions, and use the [Adaptive Contrast] function to optimize the picture brightness.

- [Iris Mode]: In dark viewing environments, using the [DarkRoom] mode is recommended for optimally balanced picture quality. In a bright environment, setting to the [BrightRoom] mode opens the projector's Iris, allowing you to enjoy a clearer picture. [User] mode allows precise adjustment of the brightness settings.
- [Adaptive Contrast]: This feature allows you to achieve high contrast.

Adjusting the Color of an Picture

 (Q. Settings) →  → [Picture] → [Advanced Settings] → [Color]

- [Color Depth]
Tones down or up the Colors displayed on the screen. The closer to 100, the deeper the Color.
- [Tint]
Adjusts the Color balance between red and green displayed on the screen. The closer to Red 50, the more red the Color will be. The closer to Green 50, the more green the Color will be.
- [Color Gamut]
Selects the range of Colors to display. Set color gamut to [Auto Detect] according to the signal, or to [Native] to display more vivid and richer color.
- [Fine Tune]
This is used when experts control it by using a test pattern. You can control it by selecting areas of six colors ([Red]/[Green]/[Blue]/[Cyan]/[Magenta]/[Yellow]). For normal images, adjustments may not result in noticeable Color changes.
 - [Color Upgrade]: Adjusts the Color and saturation of the picture to make the image more Colorful and lively.
 - [Select Color]: From [Red]/[Green]/[Blue]/[Cyan]/[Magenta]/[Yellow], select a tone to adjust.
 - [Adjust Saturation]/[Adjust Tint]/[Adjust Luminance]: Adjust the chroma/tint/luminance of the tone in the range of -30 to +30.



- [White Balance]

The function to adjust each color to be reproduced more accurately based on white allows you to adjust the overall color tone of the screen to your preference.

 - [Method]: This method is used for fine-tuning the color temperature setting. You can control the color temperature at two points of the bright part and dark part of the video if you select [2 Points], at each point of 10 levels if you select [10 Points Signal Level(%)], and at each point of 22 levels of the video if you select [22Points Signal Level(%)].
 - [Point]: Select screen brightness for color temperature adjustment. If [Method] is set to [2 Points]; use Low to select shadows and High to select highlights. When the [Method] is set to [10 Points Signal Level(%)], you can select the brightness with the 10 levels of brightness. When the [Method] is set to [22Points Signal Level(%)], you can select the brightness with the 22 levels of brightness.
 - [Signal Level(%)] : Select screen brightness for color temperature adjustment. When the [Method] is set to [10 Points Signal Level(%)], you can select the brightness with the 10 levels of brightness. When the [Method] is set to [22Points Signal Level(%)], you can select the brightness with the 22 levels of brightness.
 - [Show brightness level at the maximum signal level(%)] : Adjust the luminance to the highest IRE (100 points).
 - [Adjust brightness level at the selected signal level(%)] : You can adjust the selected brightness by points. You can use these settings only when the [Picture] → [Select Mode] is set to [Live Theater], [Expert (Bright space, daytime)], or [Expert (Dark space, night)] and when the [Method] is set to [10 Points Signal Level(%)] or [22Points Signal Level(%)].
 - [Red]/[Green]/[Blue]: Adjust the color temperature of the selected point. Adjust the intensity of [Red]/[Green]/[Blue] in the range of -50 to 50. You can adjust respective values for the brightness selected in [Point].
- [Color Temperature]

Adjusts the Color temperature cool/medium/warm.
- Depending upon the input signal or the selected picture mode, the available options may differ.
- The configurable items differ depending upon model.



Adjusting the Contrast of a Picture

 (Q. Settings) →  → [Picture] → [Advanced Settings] → [Clarity]

You can adjust the contrast of a Picture to show it more clearly.

- [Adjust Sharpness]
Adjusts the sharpness of the image. The closer to 50, the sharper and clearer the image.
- [Super Resolution]
Adjusts the resolution to make dim and blurred images clearer.
- [Noise Reduction]
Removes small dots that stand out so as to make the image clean.
- [MPEG Noise Reduction]
Reduces the noise produced during the creation of digital video signals.
- [Smooth Gradation]
It reduces the phenomenon that the outline of the image is rugged and in a staircase pattern and displays a smoother screen.
- [Cinema Screen]
Optimize display for movies.
- [TruMotion]
This feature is available on certain models only.
Optimizes the image quality of fast-moving pictures.
 - [Off]: Turns off the [TruMotion].
 - [Cinematic Movement]: Adjusts the shaking of the motion on the screen to make it feel like you are in a movie theater.
 - [Natural]: Sets images with a lot of motions to look natural and clear.
 - [Smooth Movement]: Softens fast-moving pictures.
 - [User Selection]: Sets [TruMotion] manually.
 - [De-Judder]: Adjusts juddering on the screen.
 - The advanced settings can be changed only in [User Selection] mode.
- Depending upon the input signal or the selected picture mode, the available options may differ.
- The configurable items differ depending upon model.

Applying the Current Picture Settings to All Inputs

 (Q. Settings) →  → [Picture] → [Advanced Settings] → [Apply to All Inputs]



The settings you specify only applies to the currently selected input mode. To apply your current picture settings to all input modes, select [Apply to All Inputs].

Resetting Picture Mode

 (Q. Settings) →  → [Picture] → [Advanced Settings] → [Reset]

If you want to reset the image settings to the factory defaults after configuring the image settings, select reset for each image mode.

[FILMMAKER MODE Auto Start]



 (Q. Settings) →  → [Picture] → [Advanced Settings] → [FILMMAKER MODE Auto Start]

Set to [On]. When HDMI input recognizes a movie content, it switches to [FILMMAKER MODE] automatically.

- While this mode effectively conveys the creator's intention, it may appear darker than other Select Mode.

[Sound]



Selecting Sound Mode

 (Q. Settings) →  → [Sound] → [Select Mode]

You can select the most suitable sound mode for each genre.



- [AI Sound]/[AI Sound Pro]
Automatically optimize sound based on content type.
- [Standard]
Optimizes the sound for all types of content.
- [Cinema]
Optimizes the sound for cinemas.
- [Clear Voice]/[Clear Voice Pro]
Boosts voice clarity.
- [Sports]/[Soccer]/[Cricket]
Optimizes the sound for sports.
 - The name of the sport may differ depending on region.
- [Music]
Optimizes the sound for music.
- [Game Optimizer]
Optimizes the sound for gameplay.
- This setting only applies to the internal speakers of the Projector or HDMI (ARC) connected devices that support [Projector Sound Mode Share].
- The configurable items differ depending upon model.

[Use Projector Speaker]

 (Q. Settings) →  → [Sound] → [Sound Out] → [Use Projector Speaker]

Audio is played through the projector's internal speakers.

[Use Wired Speaker]

 **(Q. Settings)** →  → [Sound] → [Sound Out] → [Use Wired Speaker]

[Optical Out Device]

You can connect an audio device that supports [Optical Out Device] to the optical digital audio output port to enjoy your projector's sound in richer quality and greater convenience.



- Only available for models with an optical digital port.
- You can use the projector remote control to adjust the volume for certain devices.

[HDMI(ARC) Device]

Sound from the projector can be output through an external audio device connected via a HDMI (ARC) port.

- Select [HDMI(ARC) Device] to automatically turn on SIMPLINK. Once SIMPLINK is turned off, the output speaker settings automatically revert to the default settings for uninterrupted audio output.

[Use Wireless Speaker]

 **(Q. Settings)** →  → [Sound] → [Sound Out] → [Use Wireless Speaker]

[WiSA Speakers]

You can wirelessly connect the projector to the [WiSA Speakers] to enjoy high-quality sound.

Select  to adjust detailed settings for [WiSA Speakers].

- Some models may not be supported.
- To use the WiSA speakers, you need to connect the exclusive dongle.
- Connection issues between the WiSA Dongle and WiSA Speaker may occur in environments with wireless interference. In this case, contact the speaker manufacturer.
- For more information on the purchase of WiSA authorized products, check on www.wisaassociation.org.



[Bluetooth Device]

You can connect wirelessly a Bluetooth audio device or a Bluetooth headset to enjoy your projector's sound in richer quality and greater convenience.

Refer to the user manual of the Bluetooth audio device for details on how to connect and use the device.

- Press **[]** to view the connected devices or any devices that can be connected and connect to any one of them.
- LG Sound Sync devices will automatically try to connect to the recently used devices when you turn the projector on.
- We recommend that you connect an LG audio device that supports LG Sound Sync, using LG TV mode or LG Sound Sync mode on device.
- Some models may not be supported.
- If the device fails to connect, check the power of the device to connect to and check if the audio device is working properly.
- Depending on the type of the Bluetooth device, the device may not connect correctly or an abnormal behavior may occur such as unsynchronized video and audio. (The mobile-only headsets may not work.)
- Sound may stutter or sound quality may be reduced if:
 - the Bluetooth device is too far from the projector;
 - there are obstacles between the Bluetooth device and the projector; or
 - used together with radio equipment such as a microwave oven or wireless LAN.
- If [Picture] → [Select Mode] is [Game Optimizer] and [Sound Out] is set to [Bluetooth Device], [Picture] → [Select Mode] is changed to [Standard].
- If you continue to experience problems, we recommend using a wired connection. (Optical digital, HDMI (ARC) port)
- Using Bluetooth speakers that support Dual mode/Double mode/2-Channel mode together with the Magic Lighting Remote may limit the speakers' usability.

[Use Multiple Speakers]

 (Q. Settings) →  → [Sound] → [Sound Out] → [Use Multiple Speakers]

Audio can be played through multiple devices simultaneously.

[Bluetooth Device + Projector Speaker]

Both the internal speaker of the projector and the Bluetooth speaker can be used to output the sound at the same time or a surround sound can be used.

Up to two Bluetooth devices of the same model can be connected.

1 Select  to connect a Bluetooth speaker.

2 Run [Audio Delay] to synchronize the projector's internal speaker with the Bluetooth speaker. You can adjust the sync automatically or manually.



- The image and voice may be out of sync while using the Screen Share mode. We recommend using [Use Projector Speaker] in [Sound Out].
- Depending on the type of your Bluetooth device, two devices may not be connected at the same time.
- Depending on the type of the Bluetooth device, the device may not connect correctly or an abnormal behavior may occur such as unsynchronized video and audio.
- Some models may not be supported.

[Optical Out Device + Projector Speaker]

Audio is played through the projector's built-in speakers and the audio device connected to the digital optical audio output port simultaneously.

- Only available for models with an optical digital port.



[Balance]

 **(Q. Settings)** →  → [Sound] → [Advanced Settings] → [Balance]

You can adjust the volume of the left and right speakers.

- This setting is only available for Internal Projector Speaker.



[Equalizer]

 **(Q. Settings)** →  → [Sound] → [Advanced Settings] → [Equalizer]

You can adjust the sound by increasing or decreasing the output of the specific frequency range of the voice signal.

- The option can be enabled if [Sound] → [Select Mode] is set to [Standard].
- This setting only applies to the internal speakers of the Projector or HDMI (ARC) connected devices that support [Projector Sound Mode Share].



[Automatic Volume Adjustment]

 **(Q. Settings)** →  → [Sound] → [Advanced Settings] → [Automatic Volume Adjustment]

If it is set to [On], the volume will be automatically adjusted to a suitable level for each content you watch to help you enjoy watching more comfortably.

- This setting only applies to the internal speakers of the Projector or HDMI (ARC) connected devices that support [Projector Sound Mode Share].

Adjusting AV Synchronization

 **(Q. Settings)** →  → [Sound] → [Advanced Settings] → [Match Screen and Sound]



Adjusts the synchronization of the sound from the speaker that is working.

The closer the value is set to 60, the slower the voice output speed will be than the default speed.

If you select the [Bypass], Outputs the sound from external devices without any audio delay. The audio may be output before the video because of the time the projector takes to process the video input.



- The adjustable items vary depending on [Sound Out].

[Select HDMI Input Audio Format]

 **(Q. Settings)** →  → [Sound] → [Advanced Settings] → [Select HDMI Input Audio Format]



You can set the audio format for each HDMI input. When the voice delivered through the HDMI port is not synchronized, set it to [PCM].



[Projector Sound Mode Share]

 **(Q. Settings)** →  → [Sound] → [Advanced Settings] → [Projector Sound Mode Share]

Link an LG sound bar that supports [Projector Sound Mode Share] and set it to [On]. [Sound] → [Select Mode] set on the projector is applied to the sound bar, allowing you to enjoy various sounds.



[Sound Bar Mode Control]

 **(Q. Settings)** →  → [Sound] → [Advanced Settings] → [Sound Bar Mode Control]

Connect an LG sound bar that supports [Sound Bar Mode Control] and set it to [On]. You can set the sound mode of the sound bar in  **(Q. Settings)** →  → [Sound] → [Select Mode] of the projector.

- Depending on the model, the name of the sound mode displayed on the sound bar may differ from that of [Sound] → [Select Mode] of the projector. In this case, it is connected to a sound mode that has a similar effect.

[LG Sound Sync]

 **(Q. Settings)** →  → [Sound] → [Advanced Settings] → [LG Sound Sync]

Connect the LG Sound Sync device to the optical digital input port and set [Sound Out] to [Optical Out Device]. By setting this feature to [On], you can adjust the volume of the connected LG Sound Sync device using a projector remote control.

- If the auto-power feature of the sound bar that supports LG Sound Sync is set to On, the sound bar will be turned on or off together when the projector is turned on or off.

[Digital Sound Output]

⚙️ (Q. Settings) → ⋮ → [Sound] → [Advanced Settings] → [Digital Sound Output]



You can configure the [Digital Sound Output] settings.

- You can set when ⚙️ (Q. Settings) → ⋮ → [Sound] → [Sound Out] → [Use Wired Speaker] is set to [Optical Out Device]/[HDMI(ARC) Device].
- When [Pass Through] is enabled, sound effects may not be output.
- The codec output with a device may differ from input signals.

	Sound Input	Digital Sound Output
[PCM]	All	PCM
[Auto] / [Pass Through]	MPEG	PCM
	Dolby Digital	Dolby Digital
	Dolby Digital Plus / Atmos	(Optical) Dolby Digital (HDMI ARC) Dolby Digital Plus / Atmos
	Dolby TrueHD (HDMI only)	(Optical) Dolby Digital (HDMI ARC) Dolby Digital Plus / Atmos
	HE-AAC	Dolby Digital

- Dolby TrueHD, HDMI eARC, Dolby Atmos: Some models may not be supported.
- When connected with HDMI eARC, the output audio type will depend on the audio type supported by the connected device.
- Depending on the connected device and the type of input audio, it may output as Dolby MAT PCM (Dolby Metadata-Enhanced Audio Transmission PCM).
- When [Digital Sound Output] is set to [Pass Through] and the HDMI input is Dolby TrueHD, Multi-Channel PCM, audio can be output as bypass.



Using an eARC Supported Audio Device

 (Q. Settings) →  → [Sound] → [Advanced Settings] → [eARC Support]

eARC is a technology that enables faster transmission of more acoustic information because it has a wider bandwidth than conventional ARC. Through the connected audio device, the sound of the projector can be output in a higher quality sound than ARC.

- 1** Connect an audio device that supports eARC to the HDMI (ARC) port.
- 2** Select [HDMI(ARC) Device] in [Sound Out] → [Use Wired Speaker].
- 3** Set [eARC Support] to [On].

Initializing Sound Settings

 (Q. Settings) →  → [Sound] → [Advanced Settings] → [Reset]

Changes the detailed sound settings of the [Standard] mode to default.

This setting only applies to the internal speakers of the Projector or HDMI (ARC) connected devices that support [Projector Sound Mode Share].



[General]

[AI Service]





 (Q. Settings) →  → [General] → [AI Service]

- [AI Sound]
When set to [On], the image quality is automatically optimized for content characteristics based on the algorithms learned with deep learning techniques.
 - This setting only applies to the internal speakers of the Projector or HDMI (ARC) connected devices that support [Projector Sound Mode Share].
- [Voice Recognition Help]
You can check the features available by voice.
- [Voice Recognition Settings]
You can set the features related to voice recognition.
- [AI Recommendation]
You can get content recommendations messages according to your content viewing history and app usage history.
 - [Smart Tips]: You can learn about useful smart features when using the projector or the app.
 - [Next Picks]: You can receive content recommendations based on your content watching pattern on the projector.
 - This feature may not be available in some countries.
 - [Reset Usage Data]: It resets the content view history and the app usage history. If you reset them, it takes some time to receive recommendations for contents again.
- The configurable items differ depending upon model.



[Game Optimizer]

 **(Q. Settings)** →  → [General] → [Game Optimizer]

Sets up the features for an immersive experience when you play with a video game console.

- 1** Press the  **(Q. Settings)** button on the remote control.
- 2** Select  on the screen.
- 3** Selecting [On] turns on all related settings.
 - It only works with HDMI inputs.
 - When [Game Optimizer] is set to [On], audio delay may occur if [Sound Out] is set to [Bluetooth Device] / [WiSA Speakers] / [Optical Out Device] / [HDMI(ARC) Device].
 - Switch to [Use Projector Speaker] or change  **(Q. Settings)** →  → [Sound] → [Advanced Settings] → [Select HDMI Input Audio Format] to [PCM].
 - The configurable items differ depending upon model.

Setting Projector

 **(Q. Settings)** →  → [General] → [Devices] → [Projector Management]

- [Home/Store Mode]

You can choose between [Home Mode] and [Store Mode].

To use the projector at home, select [Home Mode].

Select [Store Mode] only when the projector will be displayed in store. The [Store Mode] provide settings optimized for store display.

- [Projector Information]

You can check information such as [Model], [Serial Number] and [Device Name].

Managing External Device Connections

 (Q. Settings) →  → [General] → [Devices] → [Settings]

You can set to use a smart device connected to the projector to control the projector or manage the connection history.

The configurable items differ depending upon model.

- [Connect Bluetooth Controller]

You can connect and use devices such as a Bluetooth-enabled keyboard, mouse, or a gamepad with your projector.

Turn on the device, set it to pairing mode, and then click [Connect] on your projector screen. When a device you've connected before is turned on, it automatically connects to your projector. To disconnect the existing connection, click [Disconnect].

- It is recommended that you use a product that has been tested for compatibility with LG projectors.

Bluetooth Keyboard: LG Rolly Keyboard2 KBB-710, Artek HB192, LOGITECH K480, Apple Magic Keyboard, Artek HB030B Keyboard

Bluetooth Mouse: LOGITECH Mx Master 2S, LOGITECH M535, Apple Magic Mouse2

Bluetooth Gamepad: SONY Dualshock4, MICROSOFT Xbox One S, NVIDIA Shield Controller

- This feature is available for Bluetooth-enabled models only.
 - Connecting multiple Bluetooth devices may result in poor connection or operation.
 - If the Bluetooth device is too far from the projector, or there are obstacles between them, they may not operate normally.
 - Depending on the peripherals (wireless router, microwave oven, etc.), communication failures may occur.
 - If the device you selected from [Registered Devices] does not reconnect, [Disconnect] and then reconnect the device.
 - It differs among devices. When trying to connect to a device, refer to the device's User's Guide for more information.
- [Universal Control Settings]
- If you set up the universal remote control, you can control peripheral devices connected to the projector with the Magic Lighting Remote instead of their own remote controls.
- For details, please refer to "Universal Remote Control".

- [Projector On With Mobile]
If [Turn on via Wi-Fi] or [Turn on via Bluetooth] is set to [On], you can turn on your projector using an application that supports [Projector On With Mobile] or see the screen of the application on your projector.
 - The projector should be connected to a network.
 - The projector and the device to be used should be connected to the same network.
 - The [Turn on via Wi-Fi] feature must be used in an app on a smart device that supports the feature.
 - The [Turn on via Bluetooth] feature can only be used with certain LG Electronics smartphones.
 - The projector must be plugged in.
 - To connect for the first time, make sure the device to be used is ready to connect.
 - Some models may not be supported.
- [Delete Connection History]
You can delete the connection history of the devices connected to the projector on the wireless network.

Setting HDMI External Input

⚙️ (Q. Settings) → ⋮ → [General] → [Devices] → [HDMI Settings]

You can apply settings to ensure a clear picture and easy control for the HDMI connected devices.

[HDMI Deep Color]

If you connect a device that supports the [HDMI Deep Color] feature, you can view a clearer image. Connect a playback device and set [HDMI Deep Color] to [4K].

If the device doesn't support it, it may not work properly.

In that case, change the [HDMI Deep Color] setting to [Off].

- Supported Display Resolution
 - 4K: Supports 4K@60 Hz (4:4:4, 4:2:2, and 4:2:0)
 - Off: Supports 4K@60 Hz (4:2:0)
- 4K@50/60 Hz Supported Format

Resolution	Frame rate (Hz)	Color Depth/Chroma Sampling		
		8 bit	10 bit	12 bit
3840 × 2160p 4096 × 2160p	50	YCbCr 4:2:0	YCbCr 4:2:0 ¹⁾	
	59.94	YCbCr 4:2:2 ¹⁾		
	60	YCbCr 4:4:4 ¹⁾	-	-
		RGB 4:4:4 ¹⁾	-	-
1) Supported when [HDMI Deep Color] is set to [4K].				

- Settings are changeable only for the HDMI input currently being used.
- You can specify a different setting for each HDMI port.
- Some models may not be supported.

[SIMPLINK (HDMI-CEC)]

You can conveniently control and use various multimedia devices connected through HDMI with the projector's remote control.

For details, please refer to "Using SIMPLINK".

Setting a Wired Network

 (Q. Settings) →  → [General] → [Network] → [Wired Connection (Ethernet)]



If you configure settings for the network, you can use various services such as online contents and applications.

If the router connected to the network supports the DHCP feature, connecting the projector and router by wire will automatically connects to the network.

If the automatic setup is not supported, you can select [Edit] to manually set up the network connection.



- The IPv6 setup does not support [Edit].

Setting a Wireless Network

 (Q. Settings) →  → [General] → [Network] → [Wi-Fi Connection]

If you configure settings for the network, you can use various services such as online contents and applications.

If you have set up the projector for a wireless network, you can check and connect to the available wireless Internet networks.

- 1 Press the  (Q. Settings) button on the remote control.
 - 2 Select  → [General] → [Network] → [Wi-Fi Connection].
 - 3 Set to [On].
 - 4 Select the wireless router to connect.
For more detailed settings, select [Other Network].
- [Add a Hidden Wireless Network]
If you input the name of network directly, you can add a wireless network.
 - [Connect via WPS PBC]
If the wireless router you want to connect to has a Wi-Fi Protected Setup-Push Button Configuration (WPS-PBC, a button to set up a secure Wi-Fi connection) feature, you can easily connect to the wireless router by pressing the WPS-PBC button on the router. Press the wireless router's WPS-PBC button and then press the projector's [Connect] button.
 - [Connect via WPS PIN]
This is a method to connect to an access point using a Wi-Fi Protected Setup-Personal Identification Number (WPS-PIN). Select the access point (AP) to which you would like to connect. Enter the PIN displayed on the access point's Wi-Fi device.
 - [Advanced Wi-Fi Settings]
Once you connect to a wireless network you can view connection information such as detailed IP address information. In addition, you can change the IP address and DNS server address you want to connect to by pressing the [Edit] button.
 - The IPv6 setup does not support [Edit].

Configuring Language Settings

 (Q. Settings) →  → [General] → [System] → [Language]

You can choose the menu language displayed on the screen.

- [Menu Language]
You can select one of the menu languages to be displayed on the screen.
The language for the speech recognition will be automatically set to selected language for the menu.
 - The speech recognition is only applied to some models.
- [Keyboard Languages]
Select the language to use the on-screen keyboard.

Setting the Location

 (Q. Settings) →  → [General] → [System] → [Location]

You can change the location setting of your projector.

The configurable items differ depending upon model.

- [Broadcast Country]
Select the broadcasting country.
- [Address Setting]/[Zip Code]
You can set the detailed location.
 - It is subject to change depending on the broadcast country settings.
- [LG Services Country]
Select the country where you want to access LG's services. Services may vary depending on location.
 - You must set the country manually when you are not connected to the network.

Setting the Time

 (Q. Settings) →  → [General] → [System] → [Time & Timer]

You can check the time or configure related settings.

The configurable items differ depending upon model.

- [Set Automatically]
 - It automatically sets the projector time.
- [Time]/[Date]/[Time Zone]
 - You can manually set the date and time, etc.
- [Custom Time Zone]
 - When [Time Zone] is set to [Custom], [Custom Time Zone] is enabled.
- [Timers]
 - [Sleep Timer]
 - Sets the projector to turn off at a specified time.
 - If you want to disable [Sleep Timer], select [Off].
 - [Power On Timer]
 - Set [Power On Timer] to [On].
 - The projector turns on at the set time.
 - [Time]: Set the power-on time.
 - [Timer Repeat]: Set the day of the week. Set the option to [None] to operate the feature only once.
 - [Input]: Set an external input to display when the power is turned on.
 - [Volume]: Set audio volume to use when the power is turned on.
 - [Power Off Timer]
 - Set [Power Off Timer] to [On].
 - The projector is turned off at the set time.
 - [Time]: Set the time at which to turn the projector off.
 - [Timer Repeat]: Set the day of the week. Set the option to [None] to operate the feature only once.
 - [Auto Off]
 - If there is no input signal or button press, the projector automatically turns off after the preset time has elapsed.
- To use [Power On Timer]/[Power Off Timer], set the time correctly.

Setting [Safety]











 **(Q. Settings)** →  → [General] → [System] → [Safety]

To set [Safety], set it to [On].



- [Application Locks]
You can lock or unlock the application.
 - The lock function is not immediately available for the currently running application.
- [Input Locks]
You can lock or unlock the Input Locks.
- [Reset Password]
Set or change the password for the projector.
 - The initial password is set as "0000".
When France or Norway is selected for Country, the password is not "0000" but "1234".

Resetting a Lost Password

If you lose the password you set, you can reset it as follows:



- 1 Select  **(Q. Settings)** →  → [General] → [System] → [Safety].
- 2 Press   →   →   →   on the remote control. The master password input window will appear.
- 3 Enter the numbers "0313" in the master password input window, then press [Enter]. The password will be reset.

Managing your LG Account

 (Q. Settings) →  → [General] → [System] → [LG Account]



In [LG Account], you can use your email address to create a new LG account.

Using [Notifications]

 (Q. Settings) →  → [General] → [System] → [Additional Settings] → [Notifications]



You can view all notifications from projector apps and LG service at the same time. You can view and delete each notification message, and directly move to the app or website using notifications that support shortcuts.

[Home Settings]

 (Q. Settings) →  → [General] → [System] → [Additional Settings] → [Home Settings]

- [Home Auto Launch]
You can set Home to launch automatically when turning on the projector.
- The configurable items differ depending upon model.



[Pointer Options]

 (Q. Settings) →  → [General] → [System] → [Additional Settings] → [Pointer Options]

You can set the pointer speed and size you want while it is on the screen.

- [Tracking Speed]
Sets the pointer speed.
- [Pointer Size]
Selects the pointer size.

Restoring the Default Settings



 **(Q. Settings)** →  → [General] → [System] → [Reset to Initial Settings]

Return projector to its initial settings. This will revert all settings to their default values.

After reset, the projector will automatically turn off and on.

- If [Safety] is set to [On], you should type the password to [Reset to Initial Settings].
- Do not turn off the power during initialization.
- We recommended that you reset the projector to [Reset to Initial Settings] before you sell it or transfer it to a third party.



To Use Audio Guidance

 **(Q. Settings)** →  → [General] → [Accessibility] → [Audio Guidance]



If [Audio Guidance] is set to [On], audio guides will be provided in various situations, such as when you adjust the volume or change settings and input signals.

- [Speed]
Adjust the speed of spoken guide.
- [Volume]
Adjust the volume of spoken guide.
- [Pitch]
Adjust the tone of spoken guide.
- This feature is available on certain languages only.
- Some models may not be supported.
- The configurable items differ depending upon model.
- For visually impaired users.



[Projector Power Sound]

 **(Q. Settings)** →  → [General] → [Accessibility] → [Projector Power Sound]
It notifies you by sound when the projector is turned on or off. When the digital sound output is set to Pass Through, sound may not be output.



[Changing the Menu to High-Contrast Screen]

 **(Q. Settings)** →  → [General] → [Accessibility] → [High Contrast]
When this feature is set to [On], it adjusts the background of some of the menus on the screen and font colors to highlight the contrast between the light and dark areas.

[Grayscale]



 **(Q. Settings)** →  → [General] → [Accessibility] → [Grayscale]
Change the color of the menu on the screen to black and white tone to make its ambiguity very clear. Set to [On].

[Invert Colors]

 **(Q. Settings)** →  → [General] → [Accessibility] → [Invert Colors]
To enhance the visibility of the menus on the screen, you can invert and calibrate certain colors in some menus. Set to [On].

[Installation]

[PJT Mode]

 (Q. Settings) →  → [Installation] → [PJT Mode]

This function turns the projected image upside down or flips horizontal.

[Edge Adjustment]



 (Q. Settings) →  → [Installation] → [Edge Adjustment]

[Edge Adjustment] adjusts the horizontal and vertical sides of the projected image if the projector is at an angle and not perpendicular to the screen. This feature ensures the shape of the projected image is not distorted.

Use this feature only when the projector cannot be set up at the optimal angle. [Edge Adjustment] may result in a loss of image quality.

- Some models may not be supported.
- The configurable items differ depending upon model.
- You can adjust the screen by selecting one out of [4 points]/[9 points]/[15 points].
- [4 points]
Screen fit is adjustable using 4 points.
- [9 points]
Screen fit is adjustable using 9 points.
- [15 points]
Screen fit is adjustable using 15 points.

[High Altitude]

 **(Q. Settings)** →  → [Installation] → [High Altitude]

If the projector is used at an altitude higher than 1200 meters (3937.0 feet), turn this on.

Otherwise, the projector may overheat or its protection function may be activated. If this happens, turn the projector off and then on again after waiting for several minutes.

- Some models may not be supported.

[Remote Control Power]



 **(Q. Settings)** →  → [Installation] → [Remote Control Power]

The power button on the LG TV remote control can be used separately or together with the projector.

- [Projector + TV]
The power on the projector and TV can be used together.
You can turn the projector on and off with the LG TV remote control.
- [Projector Only]
The power on the projector and TV can be used separately.
You cannot turn the projector on and off with the LG TV remote control.
- Some projector models may not support this feature.
- Other company's products are not compatible.

[Support]



[Software Update]

 (Q. Settings) →  → [Support] → [Software Update]

If the software needs to be updated, run Software Update to apply the latest software version for use.

- [Auto Update]
If set to [On], updates will be proceeded automatically without asking when there is a new update after a version check.
- [Check for Updates]
When checking for the latest update version, you can perform updates only if an update file of a later version is available. The projector automatically checks your software version but, if necessary, you can perform a manual check.
- The configurable items differ depending upon model.
- The latest version can be obtained via internet connections.
- If software is not updated, certain functions may not work properly.
- In some countries, [Auto Update] is not displayed if you are not connected to the internet.

To Use Energy Saving Feature

 **(Q. Settings)** →  → [Support] → [Energy Saving]

Reduces power consumption by adjusting peak screen brightness.

If you use [Energy Saving Step] function, brightness of your projector will be affected.

- [Energy Saving Step]
 - [Minimum]/[Medium]/[Maximum]: Applies the pre-set Energy Saving mode.

- [Auto Power Off]

When the projector is on, it turns off automatically if you do not press any button within the set period of time.

- Some models may not be supported.

[Screen Self-diagnosis]

⚙️ **(Q. Settings)** → ⋮ → [Support] → [Screen Self-diagnosis]

Start the Picture Test to check that the video signal output is normal, and then select whether there is an error.

If there are no problems in the test, check the connected external device.

[Sound Self-diagnosis]

⚙️ **(Q. Settings)** → ⋮ → [Support] → [Sound Self-diagnosis]

Start the Sound Test to check that the sound signal output is normal, and then select whether there is an error.

If you have found no problems in the test, then check the connected external device.



[Privacy & Terms]

⚙️ **(Q. Settings)** → ⋮ → [Support] → [Privacy & Terms]

- [User Agreements]
These are the terms and conditions for privacy for the use of Smart projector-related services.
- [Legal Notice]
It's a legal notice for services provided via projector.
- [Open Source Software Notice]
You can view the instructions for each item.



TROUBLESHOOTING

Please check the list below when you experience the following symptoms during use of the product. It may not be a failure.

Information on customer service for product problems is available in  (Q. Settings) →  → [Support] on the projector.

Perform Check-up with the [Quick Help].

When the projector malfunctions, you can get help to solve the problem.

Push the  (Q. Settings) button of the remote control to select  → [Support] → [Quick Help].

You can also long-press the number  button of the remote control to run the [Quick Help].

- [Optimization Settings]
 - You can automatically check the overall status of your projector and view and change the recommended setting values.
- [Check Items]
 - Select the problematic item, and you can get help to solve the problem.
 - [Self-Diagnosis of Projector Settings]: Select the item that matches the symptom to find instructions that can help you solve the problem.
 - [Check the status of Projector]: You can check your projector's current status for the selected item.
- [LG Remote Service]
 - You can get help in solving the problem via Remote Service. For [LG Remote Service], make sure to contact the LG Electronics Customer Service Center.
 - Some models may not be supported.
 - This feature may not be available in some countries.
- When there is no related content in the [Quick Help], please refer to the "TROUBLESHOOTING".
- If you still fail to solve the problem, please contact our customer service center.

Troubleshooting Power/Remote Issues

Please check the list below when you experience the following symptoms during use of the product. It may not be a failure.





I cannot turn on the Projector.

- Please make sure your projector power plug is correctly connected to the outlet.
- If you are using a multi-outlet, check if it is working properly. To check whether a power strip is working properly, plug the projector's power plug directly to a wall outlet and observe its operation.
- Try to power on using the button on your projector set.
- If you are using a standby power cut-off switch, turn off the standby power cut-off and turn the power on again.

The power is on, but the screen does not turn on for some time.

- It is not a sign of defect because the screen may turn on later to prevent possible noise from the screen when the power is turned on.

The pointer of Magic Lighting Remote does not appear on the screen.

- Hold the remote control towards the projector and press the  and  (**Q. Settings**) buttons at the same time more than 5 seconds until instructions appear. The previously registered remote control is deregistered and then registered again.
- Replace the batteries when you are prompted to do so on your projector screen. (Use alkaline batteries.)
- If  (**Q. Settings**) →  → [General] → [Accessibility] → [Audio Guidance] is set to [On], the pointer of the Magic Lighting Remote does not appear. Set [Audio Guidance] to [Off]. (Some models may not be supported.)

I cannot turn the projector on with the remote control.

- Please make sure your projector power plug is correctly connected to the outlet.
- Replace the batteries in the remote control. (Use alkaline batteries.)
- Check whether there are any obstacles in front of the projector's remote control sensor. Sound bars or other obstacles placed in front of the projector's lower receiver may obstruct IR signal reception.

The power turns off suddenly.

- Make sure [Power Off Timer] is set.
- There is also a chance that the internal protection circuitry has activated because the internal temperature of the product has risen unusually or excessively.

Troubleshooting Screen Issues

Please check the list below when you experience the following symptoms during use of the product. It may not be a failure.

First of all, perform  (**Q. Settings**) →  → [Support] → [Screen Self-diagnosis] to check for any abnormalities in the projector.



If you are using a set-top box, turn it off, and then turn it back on.

Make sure that the set-top box is correctly connected to your projector.

It says there is no signal on the screen.

- Check if the cable connected to the external device is properly connected to the projector.
- Go to  to choose the connected input.
- Check if your external device, such as a set-top box or Blu-ray player, is turned on.

Part of the projected image is cut out.

- Try changing  (**Q. Settings**) →  → [Picture] → [Aspect Ratio].



The screen shakes after the momentary appearance of vertical/horizontal lines and net pattern.

- Use a different wall outlet than where you plug wireless telephones, hairdryers, electrical drills etc. The problem is caused by high-frequency electronic devices such as another projector or strong electromagnetic sources.





I see vertical lines in the left, right, top, and bottom corners of the screen, or colors are blurred when I try to connect to HDMI.

-  **(Q. Settings)** →  → [Picture] → [Aspect Ratio] → [Just Scan]
Set [Just Scan] to [Off].
[Just Scan] shows you the original image as it is. If the signal contains noise, noise may be seen in the left, right, top, and bottom corners of the screen.

I don't see anything, or the image keeps flickering when I try to connect the HDMI cable.

- Check whether your HDMI® cable is compliant with the specifications. You may experience flickering or a blank screen if the HDMI® cable is faulty (bent, broken).
- Make sure that the cable is correctly connected to the port. Bad or loose contact may cause display problems on the screen.
- When using a UHD set-top box, adjust  **(Q. Settings)** →  → [General] → [Devices] → [HDMI Settings] → [HDMI Deep Color].

The screen looks too dim or dark.



-  **(Q. Settings)** →  → [Picture] → [Select Mode]
Switch [Select Mode] to your desired picture mode. ([Standard], [Vivid], etc.)
This applies only to the current input mode.
-  **(Q. Settings)** →  → [Support] → [Energy Saving] → [Energy Saving Step]
Switch [Energy Saving Step] to [Minimum].

The screen is in black and white or displaying strange colors.

- Check the input mode or cable connection.
- Go to  to choose the connected input.
- Check the [High Contrast], [Grayscale] and [Invert Colors] settings.

Troubleshooting Sound Issues



Please check the list below when you experience the following symptoms during use of the product. It may not be a failure.

First of all, perform  **(Q. Settings)** →  → [Support] → [Sound Self-diagnosis] to check for any abnormalities in the projector.



If you are using a set-top box, turn it off, and then turn it back on.

Make sure that the set-top box is correctly connected to your projector.



The screen is fine, but it does not play any sound.

- If you use a set-top box, there will be no sound if you have set the volume of the set-top box or your projector to 0 or enabled Mute. Set the volume to an appropriate level.
-  **(Q. Settings)** →  → [Sound] → [Sound Out]
Set [Sound Out] to [Optical Out Device + Projector Speaker] or [Use Projector Speaker] and check again. If you can hear the sound normally, check the connection of the external speaker such as the sound bar and the settings of the external speaker.

There is no sound coming from one of the speakers.

-  **(Q. Settings)** →  → [Sound] → [Advanced Settings] → [Balance]
Adjust the balance as necessary with the Navigation button in [Balance].

Troubleshooting PC Connection Issues

Press and hold the  button on your remote control. Select  → [Edit] → [Edit Inputs] in the upper right corner of [Home Dashboard]. In the edit mode, set the icon of the HDMI terminal connected to the PC to [PC] to apply the video and aspect ratio settings that are aligned with the PC.



Please check the list below when you experience the following symptoms during use of the product. It may not be a failure.

To connect a different device to the same input terminal, you need to set the icon again because the settings of the edit icon will not be automatically restored.

The screen remains blank after it is connected to a PC.

- Check that the PC is properly connected to the projector.
- Turn the projector off and back on using the remote control.
- Restart the PC with the projector on.
- Make sure that the output resolution set on the PC is set to the HDMI-PC supported resolution of the projector.
- To use dual monitors, check that the PC or notebook supports dual-monitor mode.
- Reconnect the high speed HDMI® cable.
- If you have connected the RGB output port of your PC to the HDMI input port of your projector. You need an RGB to HDMI gender.
You will not see anything on the screen if you use an HDMI to RGB gender.

The screen is cut off or moved to one side after it is connected to a PC.

- Set the PC's resolution to one supported by the projector.
- Set the connected HDMI device's name to PC.
Press and hold the  button on your remote control. Select  → [Edit] → [Edit Inputs] in the upper right corner of [Home Dashboard]. Change the icon of the HDMI port connected to [Input] to PC and select [Save].

The sound does not play when the PC is connected with an HDMI® cable.

- In PC settings, set Control Panel → Sound → Play → LG projector as the default device.
- Consult your manufacturer on whether your graphics card supports HDMI audio output.

Troubleshooting Movie Playback Issues

Please check the list below when you experience the following symptoms during use of the product. It may not be a failure.

For more information about supported files, see "Using the [Media Player]".

I cannot find a file in the [Media Player].

- Check that the files on the USB storage device can be read by a PC.
- Check that the file extension is supported.
- Change the filter to [All].

I get a message saying "This file is not supported" or the sound is playing normally but the video is not.

- Check that the file plays without any problems on a PC's video player. Also check for file damage.
- Check that the file extension is supported.
- Check that the resolution is supported.
- Check that the video codec is supported.
- Check that the frame rate is supported.

I get a message saying "This audio is not supported" or the video is playing normally but the audio is not.

- Check that the file plays without any problems on a PC's video player. Also check for file damage.
- Check that the file extension is supported.
- Check that the audio codec is supported.
- Check that the bit rate is supported.
- Check that the sample rate is supported.
- Check that the audio channel separation is supported.

I cannot see the subtitles.

- Check that the file plays without any problems on a PC's video player. Also check for file damage.
- Check that the video and subtitle files have the same name.
- Also check that both the video file and the subtitle file are in the same folder.
- Check that the subtitle file format is supported.
- Check that the language is supported. (You can check the language of the subtitle file by opening the file in the Notepad.)
If subtitles encoding is incorrectly set, subtitles may not be displayed properly. Press the ▽ button on the remote control during video playback actions. Change the [Code Page] value by selecting .
- If you play a video file stored on another device by using the content sharing feature, subtitles may not be available depending on the program you use.
- Subtitles are not supported if you are playing video through an NAS unit. Consult your NAS manufacturer.

My USB storage device is not recognized when connected.





- Check whether it is a USB storage device supported by the projector. For details, please refer to "Connecting USB".

Troubleshooting Network Connection Issues

Please check the list below when you experience the following symptoms during use of the product. It may not be a failure.

Before connecting to a wireless network, check the name and password of the Wi-Fi device to connect.

You can check the network connection status as shown below.

-  **(Q. Settings)** →  → [General] → [Network] → [Wired Connection (Ethernet)]
-  **(Q. Settings)** →  → [General] → [Network] → [Wi-Fi Connection] → [Other Network] → [Advanced Wi-Fi Settings]



When X appears next to projector

- Check the projector or the AP (Router).
- Check the connection status of the projector, AP (Router) and Cable Modem.
- Power off and power on in the following order;
 1. The Cable Modem, wait for the Cable Modem to reset.
 2. Turn your cable modem off and back on, and wait for the device to reset.
 3. The projector.
- If you want to establish a wired LAN connection check whether an IP address can be obtained from your router properly. If you are setting up your network manually check whether all settings are correct.
- If you want to establish a wireless connection check the following points as well.
 1. Set your router's SSID (network name) or wireless channel.
 2. Set your router's security key.

If you do not know this setting, check the router's instruction manual and the manual provided by the Internet provider. If you are still not sure, contact the router company or the Internet company.
- If you are using a static IP, enter the IP directly.



When X appears next to Gateway

- Check the AP (Router) or consult your Internet service provider.
- Unplug the power cord of the AP (Router), Cable Modem, wait 10 seconds. Reapply power.
- Initialize (Reset) on the AP (Router) or Cable Modem.
- Check the AP (Router) manufacturer's website to make sure your router has the latest firmware version installed.
- If you do not know this setting, check the router's instruction manual and the manual provided by the Internet provider. If you are still not sure, contact the router company or the Internet company.



When X appears next to DNS

- Check the AP (Router) or consult your Internet service provider.
- Unplug the power cord of the AP (Router), Cable Modem, wait 10 seconds. Reapply power.
- Initialize (Reset) on the AP (Router) or Cable Modem.
- Check that the MAC address of the projector/AP (Router) is registered with your Internet service provider. (The MAC address displayed on the pane of the network status window should be registered with your Internet service provider.)
- If you do not know this setting, check the router's instruction manual and the manual provided by the Internet provider. If you are still not sure, contact the router company or the Internet company.

Troubleshooting LG Account Issues

In some countries, access to the website (www.lgappstv.com) may be restricted.

I have already signed up on the projector. Do I still have to sign up again at the website (www.lgappstv.com)?

- You can use the website with the membership information that you used when signing up on projector.



I forgot my Password. What should I do?

- On the projector's login screen, select the [Forgot Password?] Select the button to go to the find password page. Enter your email address on the find password page, and we'll send you a link to reset your password.
- You can also reset your password in LG Account → Reset Password on the website (www.lgappstv.com).

Troubleshooting Contents Issues

Please check the list below when you experience the following symptoms during use of the product. It may not be a failure.

I cannot see any content in HOME.

- You may not be able to see the content if the service country setting has been changed.
Change the country you want to use in  (**Q. Settings**) →  → [General] → [System] → [Location] → [LG Services Country]. (Some models may not be supported.)
- If you cannot see some apps, it may be because you deleted them. Please reinstall the appropriate app.
- If the app is deleted, you can download the app at [Apps] and reinstall it. Search for the desired app in  → [Apps] and install it.
- The type of supported content differs by country.
- The content offerings are subject to change or interruption by the service provider.

Troubleshooting Internet Browser Issues

Please check the list below when you experience the following symptoms during use of the product. It may not be a failure.

Some parts of a particular website are not visible when I am using the Internet.

- The Web Browser supports only HTML5 media and not Flash Plug-in.
- The Web Browser does not support plug-in installation.
- On the Web Browser, it may not be possible to play media files in formats other than
: JPEG/PNG/GIF
- You cannot save attachments or images.
- If the [Use Block Ads] feature is turned on, the area on the website that appears to show an ad will appear blank. If some of the content of the website is blocked and is not displayed, try setting  → [Settings] → [Use Block Ads] to [Off] in [Web Browser]. Even if [Use Block Ads] is set to [Off], [Sponsored AD] on the new tab page will be displayed.

The Internet browser automatically shuts down when I visit a website.

- The Internet browser may be forced to shut down if the available memory size is not sufficient to accommodate the image information for a website. Check if you can access the site with the issue on your PC.

When watching a video in Web Browser, the video is forced off.

- You may be able to fix this by setting  → [Settings] → [Adaptive Streaming using JavaScript] to [Off] in [Web Browser]. The setting is not applied to tabs that were open before the change, and is only applied to tabs opened after the change.

BEING AWARE OF THE INFORMATION

Supported Photo Files

File type	Format	Resolution
jpeg, jpg, jpe	JPEG	Minimum: 64 x 64 Maximum Normal Type: 15360 (W) x 8640 (H) Progressive Type: 1920 (W) x 1440 (H)
png	PNG	Minimum: 64 x 64 Maximum: 5760 (W) x 5760 (H)
bmp	BMP	Minimum: 64 x 64 Maximum: 1920 (W) x 1080 (H)

Supported Video Files

Maximum data transfer rate

- Full HD video
 - H.264 1920 x 1080@60P BP/MP/HP@L4.2 Maximum 40 Mbps
 - HEVC 1920 x 1080@60P Main/Main10@L4.1 Maximum 40 Mbps
- ULTRA HD video (ULTRA HD model only)
 - H.264 3840 x 2160@30P BP/MP/HP@L5.1 Maximum 50 Mbps
 - HEVC 3840 x 2160@60P Main/Main10@L5.1 Maximum 60 Mbps

Supported external subtitles

smi, srt, sub (MicroDVD, SubViewer 1.0/2.0), ass, ssa, txt (TMPlayer), psb (PowerDivX), dcs (DLP Cinema)

Supported embedded subtitles format

- Matroska (mkv): Sub Station Alpha (SSA), Advanced Sub Station Alpha (ASS), SRT
- MP4 (mp4): Timed Text

Supported video codecs

Extension	Codec	
asf wmv	Video	VC-1 Advanced Profile (except for WMVA), VC-1 Simple and Main Profiles
	Audio	WMA Standard (except for WMA v1/ WMA Speech)
avi	Video	Xvid (except for GMC), H.264/AVC, Motion Jpeg, MPEG-4
	Audio	MPEG-1 Layer I, II, MPEG-1 Layer III (MP3), Dolby Digital, LPCM, ADPCM
mp4 m4v mov	Video	H.264/AVC, MPEG-4, HEVC, AV1
	Audio	Dolby Digital, Dolby Digital Plus, AAC, MPEG-1 Layer III (MP3), Dolby AC-4, MPEG-H 3D Audio
3gp 3g2	Video	H.264/AVC, MPEG-4
	Audio	AAC, AMR-NB, AMR-WB
mkv	Video	MPEG-2, MPEG-4, H.264/AVC, VP8, VP9, HEVC, AV1
	Audio	Dolby Digital, Dolby Digital Plus, AAC, PCM, MPEG-1 Layer I, II, MPEG-1 Layer III (MP3)
ts trp tp mts	Video	H.264/AVC, MPEG-2, HEVC
	Audio	MPEG-1 Layer I, II, MPEG-1 Layer III (MP3), Dolby Digital, Dolby Digital Plus, AAC, PCM, Dolby AC-4
mpg mpeg dat	Video	MPEG-1, MPEG-2
	Audio	MPEG-1 Layer I, II, MPEG-1 Layer III (MP3)
vob	Video	MPEG-1, MPEG-2
	Audio	Dolby Digital, MPEG-1 Layer I, II, DVD-LPCM

- Dolby AC-4, MPEG-H 3D Audio: Some models may not be supported.

Cautions for Video Playback

- Some user-created subtitles may not work properly.
- A video file and its subtitle file must be located in the same folder. For subtitles to be displayed properly, make sure that the video file and the subtitle file have the same name.
- Subtitles on a Network Attached Storage (NAS) device may not be supported depending on the manufacturer and model.
- Streams that include Global Motion Compensation (GMC) and Quarterpel Motion Estimation (Qpel) are not supported.
- ULTRA HD video (ULTRA HD model only): 3840 x 2160, 4096 x 2160
Some HEVC-encoded ULTRA HD videos other than the content officially provided by LG Electronics may not be played.
Some codecs can be supported after a software upgrade.

Extension	Codec	
mkv	Video	H.264/AVC, HEVC
mp4	Audio	Dolby Digital, Dolby Digital Plus, AAC
ts		

- Only Window Media Audio V7 and later are supported.
- The AAC main profile is not supported.
- Video files created by some encoders may not be played.
- Video files in a different format than specified may not be played properly.
- Video files stored on a USB storage device that does not support High Speed may not be played properly.

Supported music file formats

File type	Item	Info
mp3	Bit rate	32 kbps ~ 320 kbps
	Sample freq.	16 kHz ~ 48 kHz
	Support	MPEG-1, MPEG-2
	Channels	mono, stereo
wav	Bit rate	-
	Sample freq.	8 kHz ~ 96 kHz
	Support	PCM
	Channels	mono, stereo
ogg	Bit rate	64 kbps ~ 320 kbps
	Sample freq.	8 kHz ~ 48 kHz
	Support	Vorbis
	Channels	mono, stereo
wma	Bit rate	128 kbps ~ 320 kbps
	Sample freq.	8 kHz ~ 48 kHz
	Support	WMA
	Channels	up to 6 ch
flac	Bit rate	-
	Sample freq.	8 kHz ~ 96 kHz
	Support	FLAC
	Channels	mono, stereo

- The number of supported channels may vary depending upon the sample frequency.

