

Watch Operation Guide 5741

CASIO®

Contents

About This Watch

[General Guide](#)[Watch Face and Display Indicators](#)[Navigating Between Modes](#)[Mode Overview](#)[Using the Crown](#)[Shifting the Hands](#)[Charging](#)[Viewing the Face in the Dark](#)[Useful Features](#)

Linking with a Phone

[Getting Ready](#)[Auto Time Correction](#)[Mode Customization](#)[Recording Your Current Location \(Location Memory\)](#)[Checking the Distance and Bearing to a Location Memory Point \(Location Indicator\)](#)[Auto Altitude Calibration](#)[Recording Waypoints and Their Altitudes \(Route Log\)](#)[Configuring World Time Settings](#)[Adjusting Hand Alignment](#)[Phone Finder](#)[Configuring Watch Settings](#)[Changing the Home City Summer Time Setting](#)[Checking the Watch Charge Level](#)[Recording Your Current Location \(TIME&PLACE\)](#)[Connection](#)

- [Connecting with a Phone](#)
- [Disconnecting the Watch from a Phone](#)
- [Unpairing the Watch from a Phone](#)
- [If you purchase another phone](#)

Time Correction

[Time Adjustment Using a Time Signal](#)

- [Overview](#)
- [Appropriate Signal Reception Location](#)
- [Time Signal Reception Ranges](#)
- [Auto Time Calibration Signal Receive](#)
- [Enabling and disabling Auto Receive](#)
- [Manual Time Calibration Signal Receive](#)
- [Receive Level Indicator](#)
- [Checking the Last Time Adjustment Result](#)
- [Signal Reception Precautions](#)

[Using Watch Operations to Adjust the Time Setting](#)[Using the Watch in a Medical Facility or Aircraft](#)

World Time

[Using the CASIO WATCHES Phone App to Configure World Time City Settings](#)[Checking World Time](#)[Setting the World Time City](#)[Swapping Your Home Time and World Time](#)[Moving Between Time Zones](#)

Alarm

[Using the CASIO WATCHES Phone App to Configure Alarm Settings](#)[Configuring Alarm Settings](#)[Enabling the Hourly Time Signal](#)[Turning Off an Alarm or the Hourly Time Signal](#)

Digital Compass

Taking a Compass Reading

Saving a Bearing to a Destination (Bearing Memory)

Calibrating Compass Readings

- Calibrating Compass Readings

- Setting Up for True North Readings (Magnetic Declination Calibration)

Digital Compass Reading Precautions

Altitude Measurement

Checking the Current Altitude

Calibrating Altitude Readings (Offset)

Checking the Altitude Differential from a Reference Point

Setting the Auto Measurement Interval

Recording Altitude Readings

Specifying the Altitude Measurement Unit

Altitude Reading Precautions

Barometric Pressure Measurement

Checking the Current Barometric Pressure

Checking Changes in Barometric Pressure Over Time

Checking the Change in Barometric Pressure between Two Readings

Sudden Barometric Pressure Change Indications

Calibrating Barometric Pressure Readings (Offset)

Specifying the Barometric Pressure Unit

Barometric Pressure Reading Precautions

Temperature Measurement

Checking the Current Temperature

Calibrating Temperature Readings (Offset)

Specifying the Temperature Measurement Unit

Temperature Reading Precautions

Viewing Altitude Records

Viewing Recorded Data

Deleting Data

Sunrise and Sunset Times

Looking Up Today's Sunrise and Sunset Times

Looking Up Sunrise and Sunset Times by Specifying a Day

Stopwatch

Measuring Elapsed Time

Measuring a Split Time

Timing the First and Second Place Finishers

Timer

Using the CASIO WATCHES Phone App to Configure Timer Settings

Setting a Start Time

Using the Timer

Hand Alignment Adjustment

Using the CASIO WATCHES Phone App to Adjust Hand Alignment

Adjusting Hand Alignment

Other Settings

Enabling the Button Operation Tone

Configuring Power Saving Function Settings

Resetting Watch Settings

Specifications

Other Information

City Table

Summer Time Table

Supported Phone Models

Copyrights and Registered Trademarks

Troubleshooting

Precautions

Operating Precautions

User Maintenance

Battery

Mobile Link Precautions

About This Watch

This section provides an overview of the watch and introduces convenient ways it can be used.

● Watch Features

● Phone Linking

The watch supports connection and communication with a Bluetooth capable phone.

● Solar Charging

Sunlight and artificial light generate electricity for watch operation as it charges.

● Time Signal Reception

The watch receives a radio signal containing time information and uses it to keep its time setting accurate.

● World Time

World Time displays the current time in any of 55 cities (38 time zones)* around the globe and UTC.

* Subject to being updated when connected with a phone.

● Alarm

An alarm sounds whenever a time specified by you is reached.

● Digital Compass

You can use the Compass Mode to determine the direction of north, and to check your bearing to a destination.

● Altitude Measurement

You can use this function to take an altitude reading at your current location.

You can record the altitude, along with the date and time of the measurement. You can also measure the altitude differential between two points.

● Barometric Pressure Measurement

You can display the current barometric pressure tendency, which helps you be on the alert for noteworthy pressure changes.

● Temperature Measurement

The watch can be used to take current air temperature readings.

● Viewing Altitude Records

You can view or delete records of altitude measurements.

● Sunrise and Sunset Times

You can look up the sunrise and sunset times for a specified date.

● Stopwatch

You can use the stopwatch to measure up to 24 hours of elapsed time in units of 1/100 of a second.

● Timer

Countdown from a start time specified by you. An alarm sounds when the countdown reaches zero.

Important!

- This watch is not a special-purpose measuring instrument. Measurement function readings are intended for general reference only.
- Whenever using the Digital Compass of this watch for serious trekking, mountain climbing, or other activities, be sure to always take along another compass to confirm readings. If the readings produced by the Digital Compass of this watch are different from those of the other compass, perform 3-point calibration or figure 8 calibration of the watch compass to correct direction measurement.
 - Compass readings and calibration will not be possible if the watch is in the vicinity of a permanent magnet (magnetic accessory, etc.), metal objects, high-voltage wires, aerial wires, or electrical household appliances (TV, computer, cellphone, etc.)
- [Digital Compass](#)
- The watch's altimeter function calculates and displays relative altitude based on barometric pressure readings produced by its pressure sensor. Because of this, altitude values displayed by the watch may be different from your actual elevation and/or sea level elevation indicated for the area where you are located. Regular calibration in accordance with the local altitude (elevation) indications is recommended.
 - [Altitude Measurement](#)

Note

- The illustrations included in this operation guide have been created to facilitate explanation. An illustration may differ somewhat from the item it represents.

General Guide

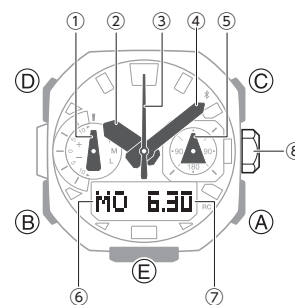

- ① Function hand
- ② Hour hand
- ③ Second hand
- ④ Minute hand
- ⑤ Bearing hand
- ⑥ Day of the week
- ⑦ Month, day
- ⑧ Crown

A button

Pressing this button in the Timekeeping Mode enters the Altimeter Mode.

B button

Each press cycles between watch modes.

In any mode, hold down this button for at least two seconds to return to the Timekeeping Mode.

C button

Pressing this button in the Timekeeping Mode enters the Compass Mode.

D button

Pressing this button in the Timekeeping Mode cycles between displays.

E button

Press to turn on illumination.

Watch Face and Display Indicators

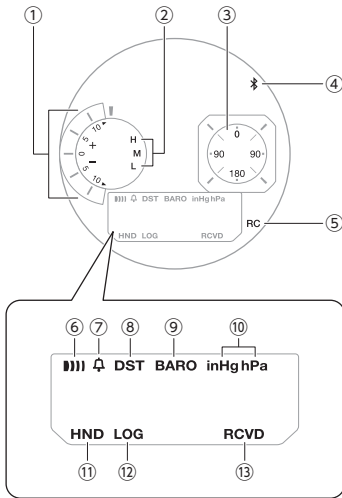

- ① The function hand indicates the altitude or barometric pressure difference.
- ② The function hand indicates the current charge level after you enter the Timekeeping Mode.
- ③ The bearing hand indicates the bearing to a destination (in Bearing Memory) or to a location you recorded (in Location Memory).
- ④ When the watch is connected with a phone, the second hand points to ✂.
- ⑤ The second hand points to [RC] while the watch is standing by for connection with a phone.
- ⑥ Displayed when an alarm is turned on.

- ⑦ Appears when the hourly time signal is on.
- ⑧ Displayed when the indicated time is summer time.
- ⑨ Displayed while barometric pressure change indication is enabled.
- ⑩ Shows the barometric pressure measurement unit.
- ⑪ Flashes while the watch's hands are shifted for easier reading.
- ⑫ Displayed while Route Log is enabled.
- ⑬ Displayed after time adjustment using time signal reception or connection with a phone was successful. The [RCVD] indicator will disappear in the cases below.
 - After you use watch operations to change Home City settings (time and date, city, summer time)
 - After the watch switches between standard time and summer time
 - After a time signal receive operation fails
 - After a phone-based time adjustment operation fails

Navigating Between Modes

Your watch has the modes shown below.

- To return to the Timekeeping Mode from any other mode, hold down (B) for at least two seconds.

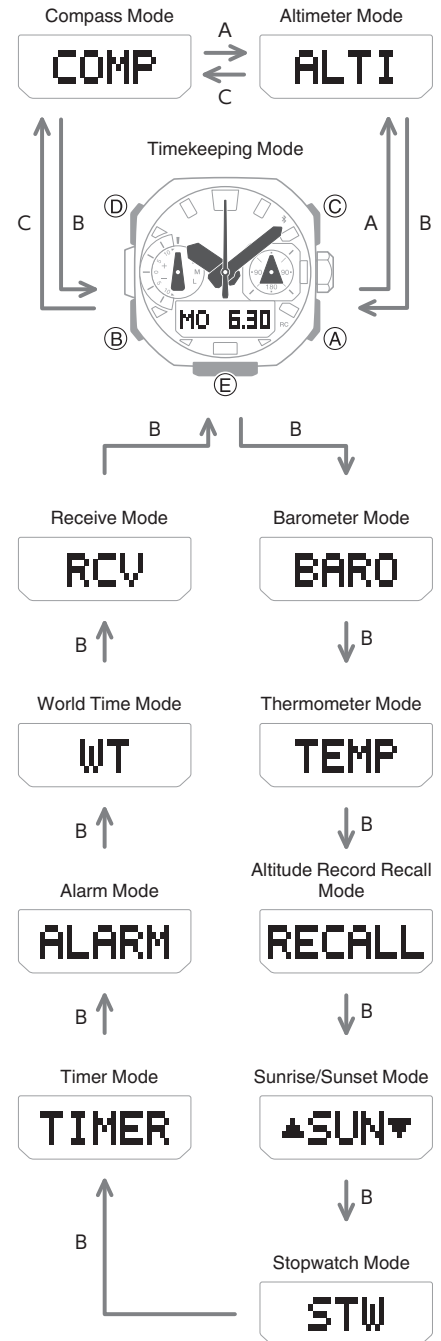

Use the buttons in the illustration above to navigate between modes.

Mode Overview

● Timekeeping Mode

In this mode, the digital display shows the current day of the week, month, and day. You can also use (D) to scroll display contents through the items below.

- Barometric pressure graph, month, day
- Hour, minute, second

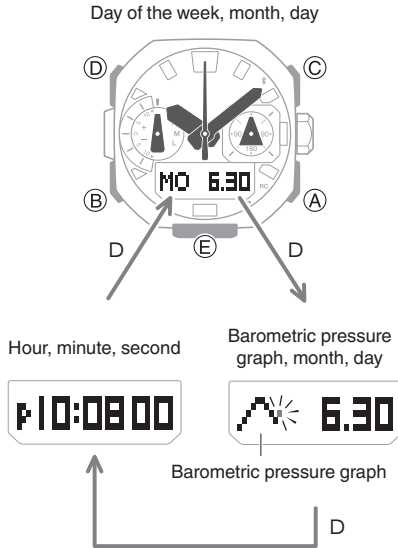

Note

- To perform operations with CASIO WATCHES, you first need to pair the watch with the phone where the app is installed.

③ Pair the watch with a phone.

● Altimeter Mode

Use this mode to take an altitude reading for your current location.

🔗 [Altimeter Measurement](#)

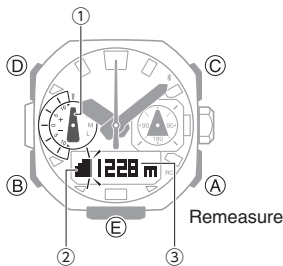

- ① Altitude differential indicator
- ② Altitude graph
- ③ Altitude

● Compass Mode

Use this mode to take direction and bearing angle readings.

🔗 [Digital Compass](#)

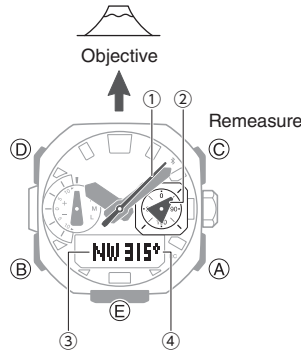

- ① North indication
- ② Bearing Memory/Location Memory Bearing
- ③ Bearing at 12 o'clock
- ④ Bearing angle at 12 o'clock

● Barometer Mode

Use this mode to take barometric pressure readings at your current location.

🔗 [Barometric Pressure Measurement](#)

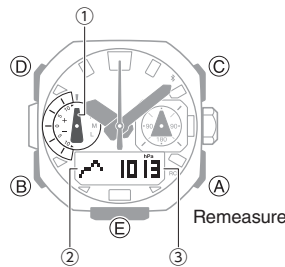

- ① Pressure Differential Indicator
- ② Barometric pressure graph
- ③ Barometric pressure

● Thermometer Mode

Use this mode to take temperature readings at your current location.

🔗 [Temperature Measurement](#)

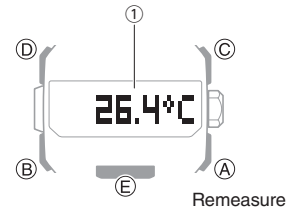

- ① Temperature

● Altitude Record Recall Mode

Use this mode to view altitude records.

🔗 [Viewing Altitude Records](#)

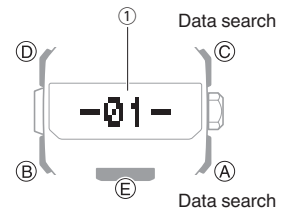

- ① Number of the record displayed last time the Altitude Record Recall Mode was used

● Sunrise/Sunset Mode

Use this mode to check the sunrise and sunset times for your Home City.

🔗 [Sunrise and Sunset Times](#)

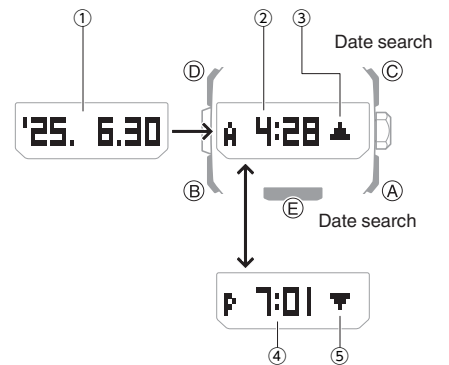

- ① Year, month, day
- ② Sunrise time
- ③ Sunrise indicator
- ④ Sunset time
- ⑤ Sunset indicator

● Stopwatch Mode

Use this mode to measure elapsed time.

[Stopwatch](#)

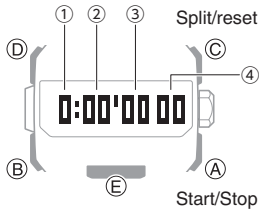

- ① Stopwatch hours
- ② Stopwatch minutes
- ③ Stopwatch seconds
- ④ Stopwatch: 1/100 second

● Timer Mode

Use this mode to countdown from a desired start time.

[Timer](#)

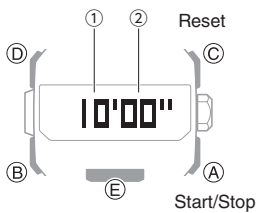

- ① Timer minutes
- ② Timer seconds

● Alarm Mode

The watch will beep when an alarm time is reached.

[Alarm](#)

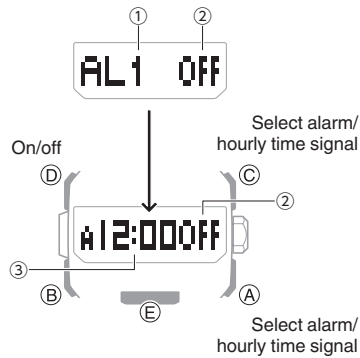

- ① Alarm number
- ② Alarm or hourly time signal status (on/off)
- ③ Alarm hour/minute

● World Time Mode

This mode shows the current time in 55 cities and UTC (Coordinated Universal Time) time.

[World Time](#)

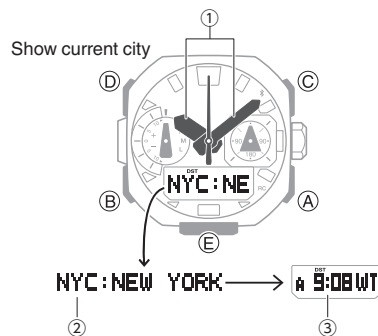

- ① Home City time
- ② World Time City
- ③ World Time City current time

● Receive Mode

With this mode, you can receive a time signal manually.

[Time Adjustment Using a Time Signal](#)

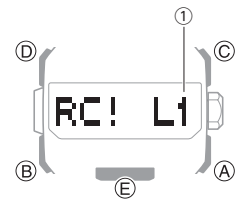

- ① Receive level indicator

Connecting with a Paired Phone to Correct the Watch's Time

Press (A).

[Triggering Immediate Time Correction](#)

Searching for a Paired Phone

Hold down the (A) button for about five seconds.

[Phone Finder](#)

Using the Crown

The watch's crown is a screw-in (screw lock) type. To use the crown, you first need to rotate it towards you (leftwards) to loosen it.

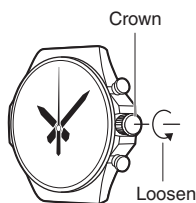

Important!

- To prevent loss of water resistance and/or damage due to impact, be sure to screw the crown in by rotating it away from you as you push it in.

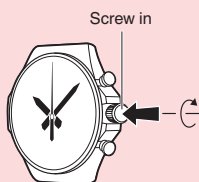

- When pushing the crown back in, take care not to apply too much force.

● Fast Forward/Fast Reverse

After pulling out the crown, rotating it quickly in succession in either direction will start a fast forward or fast reverse operation. While adjusting the time setting manually using watch operations, rotating the crown quickly in succession again while a fast forward operation is in progress will cause the hour and minute hands to move faster.

● Stopping Fast Forward/Fast Reverse

Rotate the crown in the direction opposite that of the ongoing operation or press any button.

Note

- If you do not perform any operation for about two minutes after pulling out the crown, crown operations will automatically become disabled. If that happens, push the crown back in and then pull it out again. If operation after pulling the crown is disabled, the display will appear as shown below immediately after you pull out the crown. If that happens, push the crown back in and lock it.



Shifting the Hands

Hand shift moves the hands out of the way for easy viewing of display information.

- While holding down (E), press (B).

This shifts the analog hands to allow easy viewing of display information.

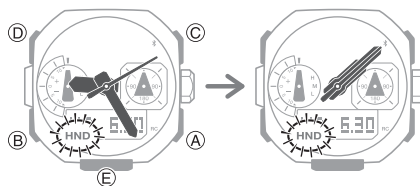

- To return the hands to their normal timekeeping positions, hold down (E) as you press (B) again, or press (B) to change to another mode.

Note

- If you leave the watch with its hands shifted and do not perform any operation for about one hour, the hands resume normal timekeeping automatically.

Charging

This watch runs on power supplied from a rechargeable (secondary) battery that is charged by a solar panel. The solar panel is integrated into the face of the watch, and power is generated whenever the face is exposed to light.

● Charging the Watch

When you are not wearing the watch, put it in a location where it is exposed to bright light.



While you are wearing the watch, make sure that its face (solar panel) is not blocked from light by the sleeve of your clothing. Power generation efficiency is reduced even when the face of the watch is blocked only partially.

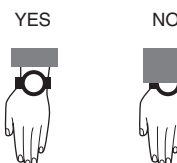

Important!

- Some light sources and environments can cause the watch to become extremely hot during charging, which creates the risk of burn injury and damage to internal watch components. Avoid charging the watch under conditions like the ones described below, where the temperatures may exceed 60 °C (140 °F).
 - On the dashboard of a vehicle parked in the sun
 - Near incandescent lamps, camera lights, halogen lamps, or other sources of heat
 - In locations exposed to direct sunlight for long periods and other hot locations
- The display panel may become black (or white, depending on the LCD type) under very high temperatures. This is temporary, and the display will return to normal at lower temperatures.

● Checking the Charge Level

When you enter the Timekeeping Mode, a display indicator and the function hand show the watch's current charge level.

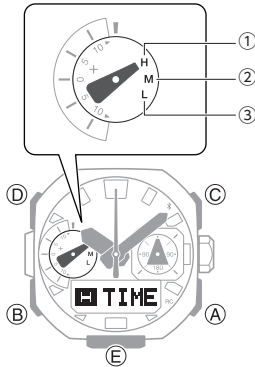

① Good (Charge Level 1)

② Good (Charge Level 2)

③ Low (Charge Level 3)

- The display will show charge levels 4 and 5, even if the watch is not in the Timekeeping Mode.

Charge Level 1: Good

All functions enabled.



Charge Level 2: Good

All functions enabled.



Charge Level 3: Low

The functions below are disabled. Also, the second hand jumps at two-second intervals.

- Time signal reception
- Compass, altitude, barometric pressure, temperature measurements
- Face illumination
- Sounds (alarms, etc.)
- Connection with a phone

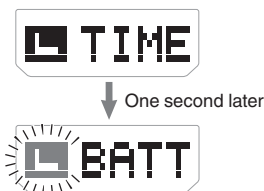

Charge Level 4: Low

Battery charge is lower than Level 3, and all functions are disabled. Also, all hands are stopped.

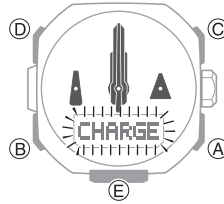

Charge Level 5: Dead

All hands are stopped and digital displays are blank. Memory data is lost, and watch settings are returned to their initial factory defaults.

Important!

- Should the battery go low or go dead, expose the face (solar panel) to light as soon as possible.

Note

- If [RECOVER] is flashing on the display, it means that all functions are disabled due to momentary battery power consumption.
 [RECOVER] is flashing on the display.
- Exposing the watch face to light after the battery goes dead causes the [CHARGE] indicator to appear. This indicates charging has started.

● Charging Time Guidelines

The table below shows guidelines for approximate charging times.

Charging Times Required for 1 Day of Operation

Light Level (Lux)	Approximate Charging Time
50,000	8 minutes
10,000	30 minutes
5,000	48 minutes
500	8 hours

Charge Recovery Times

- Sunny day, outdoors (50,000 lux)

Dead battery → Medium charge	2 hours
Medium charge → High charge	20 hours
High charge → Full charge	6 hours

- Sunny day, near a window (10,000 lux)

Dead battery → Medium charge	6 hours
Medium charge → High charge	73 hours
High charge → Full charge	20 hours

- Overcast day, near a window (5,000 lux)

Dead battery → Medium charge	9 hours
Medium charge → High charge	119 hours
High charge → Full charge	32 hours

- Indoor fluorescent lighting (500 lux)

Dead battery → Medium charge	104 hours
Medium charge → High charge	-
High charge → Full charge	-

Note

- Actual charging time depends on the charging environment, watch settings, and other factors.

● Power Saving Function

Leaving the watch in a dark location for about one hour between the hours of 10 p.m. and 5:50 a.m. causes the display to go blank and then the watch enters Level 1 power saving. If the watch is left in this condition for six or seven days, it enters Level 2 power saving.

Power Saving Level 1 :

The second hand stops at 12 o'clock and the digital display goes blank to save power. The watch can connect with a phone at this level.

Power Saving Level 2 :

All hands stop and the digital display goes blank to save power. All functions are disabled.

Recovering from Power Saving Operation

Use one of the operations below to exit power saving.

- Press any button.
- Move the watch to a bright location.
- Trigger Full Auto Light by angling the watch towards your face.

Note

- The watch will not enter power saving in the cases below.
 - While in the Stopwatch Mode
 - While in the Timer Mode
 - While the barometric pressure change indicator is displayed
- You can enable or disable Power Saving.
 - 🔍 [Configuring Power Saving Function Settings](#)
- Note that the watch also may enter power saving if its face is blocked from light by your sleeve while you are wearing it.

Viewing the Face in the Dark

The face of the watch can be illuminated for viewing in the dark.

● To illuminate the face manually

Press (E) to turn on illumination.

- Illumination turns off automatically if an alarm starts to sound or if you perform a crown operation.
- Illumination does not turn on while a signal receive operation or a hand movement operation is in progress. Also, illumination may not turn on while a sensor is taking a reading.

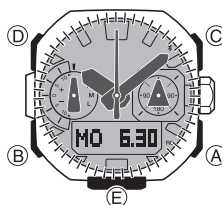

● To illuminate the face when Auto Light is enabled

If Full Auto Light is enabled, face illumination turns on automatically whenever the watch is positioned at an angle of 40 degrees or more.

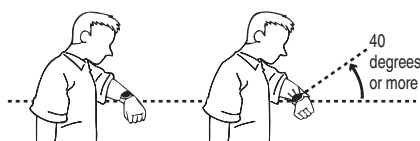

Important!

- Auto Light may not operate properly when the watch is at a horizontal angle of 15 degrees or greater from horizontal as shown in the illustration below.



- Electro-static charge or magnetism can interfere with proper Full Auto Light operation. If this happens, try lowering your arm and then angle it towards your face again.
- When moving the watch you may note a slight rattling sound. This is the sound of Full Auto Light switch operation and does not indicate malfunction.

Note

- Full Auto Light does not turn on illumination if you are in a well-lit location.
- Full Auto Light is disabled when any one of the conditions below exists.
 - While an alarm, timer alert, or other beeper is sounding
 - While a hand movement operation is in progress
 - While in the Compass Mode
 - While a time signal receive operation is in progress
 - While Bluetooth Communication is in progress

● Configuring the Full Auto Light Setting

You can enable or disable Full Auto Light as required.

1. Enter the Timekeeping Mode.
[🔗 Navigating Between Modes](#)

2. Loosen the crown and then pull it out.
 The currently selected Home City will appear on the display.

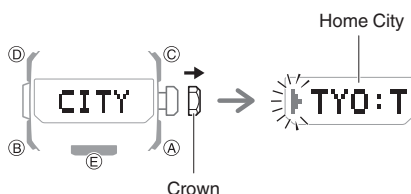

3. Press (B) three times.
 [AUTO] appears on the display with [ON] or [OFF] flashing.

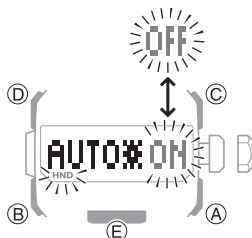

4. Rotate the crown to enable or disable Full Auto Light.
5. Push the crown back in and then lock it.

Note

- If you do not perform any operation for about two minutes after pulling out the crown, crown operations will automatically become disabled. If that happens, push the crown back in and then pull it out again.

● Specifying the Illumination Duration

You can select either 1.5 seconds or three seconds as the illumination duration.

1. Enter the Timekeeping Mode.
[🔗 Navigating Between Modes](#)

2. Loosen the crown and then pull it out.
 The currently selected Home City will appear on the display.

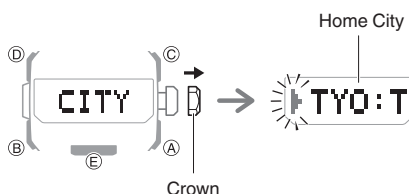

3. Press (B) four times.
 [LIGHT] appears on the display with [1] or [3] flashing.
4. Rotate the crown to select an illumination duration.
 [1]: 1.5-second illumination
 [3]: 3-second illumination

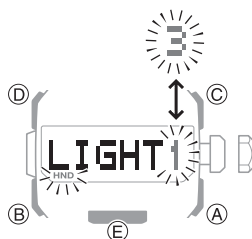

5. Push the crown back in and then lock it.

Note

- If you do not perform any operation for about two minutes after pulling out the crown, crown operations will automatically become disabled. If that happens, push the crown back in and then pull it out again.

Useful Features

Pairing the watch with your phone makes a number of the watch's features easier to use.

Auto time correction

- 🔗 [Auto Time Correction](#)



Selection of More Than 300 World Time cities

- 🔗 [Configuring World Time Settings](#)

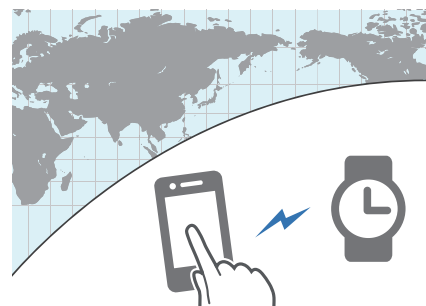

Use your phone to check the distance and bearing to a point in Location Memory

- ☞ [Checking the Distance and Bearing to a Location Memory Point \(Location Indicator\)](#)



Use your phone to record route waypoints and their altitudes

- ☞ [Recording Waypoints and Their Altitudes \(Route Log\)](#)

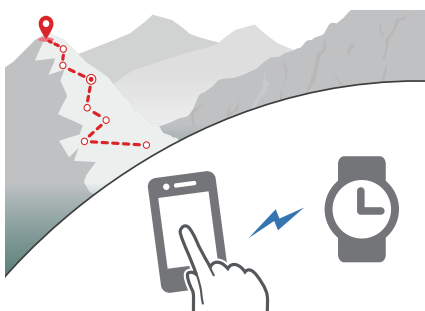

In addition, a number of other watch settings can be configured using your phone.

To transfer data to a watch and to configure settings, you first need to pair the watch with your phone.

- ☞ [Getting Ready](#)

- Your phone needs to have the “CASIO WATCHES” phone app installed to pair with the watch.

Linking with a Phone

While there is a Bluetooth connection between the watch and phone (Mobile Link), the watch’s current time setting is corrected automatically. You can also change the watch’s other settings.

Note

- This function is available only while the CASIO WATCHES phone app is running on the phone.
- This section describes watch and phone operations.
 - 🕒 : Watch operation
 - 📱 : Phone operation

Getting Ready

To use your watch in combination with a phone, you first need to pair them. Perform the steps below to pair the watch with a phone.

- ① Install the app on your phone.
- ② Configure Bluetooth settings.
- ③ Pair the watch with a phone.

● ① Install the app on your phone.

In Google Play or the App Store, search for the “CASIO WATCHES” phone app and install it on your phone.

● ② Configure Bluetooth settings.

Enable the phone’s Bluetooth.

Note

- For details about setting procedures, see your phone documentation.

● ③ Pair the watch with a phone.

1. Move the phone to be paired with close to (within one meter of) the watch.
2. 📱 Tap the “CASIO WATCHES” icon.
3. 📱 Tap the + of the “My Watch” tab.
4. 📱 Perform the operation shown on the phone screen to register the watch to the CASIO WATCHES phone app.
5. 🕒 Hold down (B) for at least five seconds. Release the button when the second hand points to , and [CNCT] flashes on the display.

When a connection is established between the watch and phone, [CNCT] will stop flashing.

At this time the time settings of your phone and watch are synced with each other.

- If pairing fails for some reason, [ERR] appears on the display momentarily and then the watch returns to the Timekeeping Mode. Perform the pairing procedure again from the beginning.

Pairing started

Pairing complete

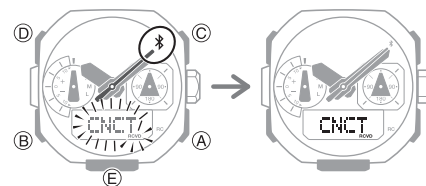

This completes the pairing operation.

Once paired, the smartphone and watch automatically connect to synchronize the watch’s time setting with that of the smartphone.

Note

- The first time you start up the CASIO WATCHES phone app, a message will appear on your phone asking if you want to enable location information acquisition. Configure settings to allow background use of location information.

Auto Time Correction

Your watch connects with a phone at preset times each day and correct its time settings automatically.

● Using This Function

Your watch corrects its time setting four times a day according to a preset schedule. If you leave your watch in the Timekeeping Mode, it will perform the correction operation automatically as you go about your daily life, without any operation required by you.

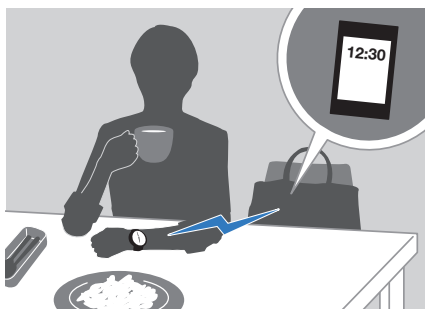

Important!

- The watch may not be able to perform auto time correction under the conditions described below.
 - While the watch is too far away from its paired phone
 - While communication is not possible due to radio interference, etc.
 - While the phone is updating its system
 - While the CASIO WATCHES phone app is not running on the phone

Note

- If the watch does not indicate the correct time even if it is able to connect with a phone, adjust the hand positions.
 - [Adjusting Hand Alignment](#)
- If there is a World Time City specified with the CASIO WATCHES phone app, its time will also be corrected automatically.
- The watch connects with the phone and performs auto time correction at around 12:30 a.m., 6:30 a.m., 12:30 p.m. and 6:30 p.m. The connection is automatically terminated after auto time correction is complete.
- Time signal auto-receive will be performed if there has been no auto time correction based on connection between the watch and phone for more than one day.

● Triggering Immediate Time Correction

The watch's time setting is corrected automatically whenever you establish a connection between the watch and a phone. Whenever you want to trigger immediate time correction, perform the procedure below to connect with a phone.

1. Enter the Receive Mode.
 - [Navigating Between Modes](#)
2. Move the phone close to (within one meter of) the watch.
3. Press (A).

[TIME] flashes to indicate that the watch has started the connection operation. Once the watch and phone are connected, [OK] will appear, and then the watch will correct its time setting based on information from the phone.

 - At this time your current location is recorded by your phone.

Trying to connect

After time correction

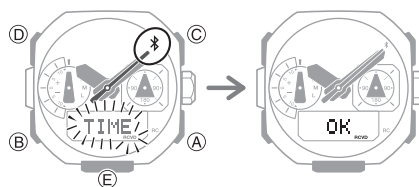

Note

- The connection is terminated automatically after time correction is complete.
- If time correction fails for some reason, [ERR] will appear.
- [RCVD] flashes when the receive operation starts, and [RCVD] stops flashing after it is complete.

Mode Customization

You can use CASIO WATCHES to customize modes by rearranging them on the screen, and by deleting or adding modes.

Important!

- You cannot perform mode customization operations on the watch. Use CASIO WATCHES to configure settings.

The modes below can be rearranged or deleted.

- Barometer Mode
- Thermometer Mode
- Altitude Record Recall Mode
- Sunrise/Sunset Mode
- Stopwatch Mode
- Timer Mode
- Alarm Mode
- World Time Mode

1. Tap the "CASIO WATCHES" icon.
2. Hold down (B) for at least five seconds. Release the button when the second hand points to , and [CNCT] flashes on the display.

When a connection is established between the watch and phone, [CNCT] will stop flashing.

Trying to connect

Connected

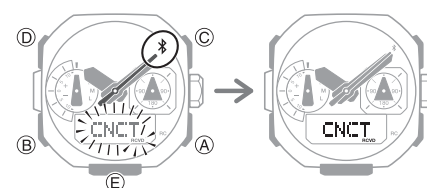

3. Perform the operations shown on the phone screen to configure mode settings.

Note

- Increasing or decreasing the number of modes may change mode functions and/or settings.
- Even if you remove the Barometer Mode, you can still display the barometric pressure graph on the Timekeeping Mode screen.

To initialize Mode Customization

Important!

- Initializing Mode Customization also initializes watch settings.

Note

- Mode Customization cannot be initialized while Route Log is enabled.

- Enter the Timekeeping Mode.
[Navigating Between Modes](#)
- Loosen the crown and then pull it out. The currently selected Home City will appear on the display.

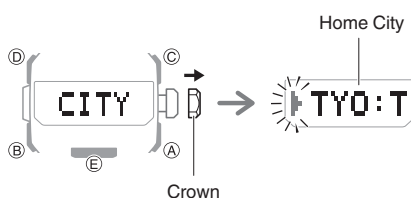

- Hold down (A) for at least seven seconds. Release the button when [CLEAR] stops flashing. This initializes Mode Customization.
- Push the crown back in and then lock it.

Recording Your Current Location (Location Memory)

You can use CASIO WATCHES to record current location information.

- Tap the "CASIO WATCHES" icon.
- Enter the Compass Mode.
[Navigating Between Modes](#)
- Hold down (C) for at least five seconds. Release the button when [MEMORY] starts to flash, and the second hand points to .

When a location information receive operation is successful while the watch is connected with a phone, [MEMORY] will change to [OK].

- [ERR] will appear on the display if connection fails for some reason.
- [FAILED] → [POSITION] will appear in sequence if location information acquisition fails for some reason.

Trying to connect

Connected

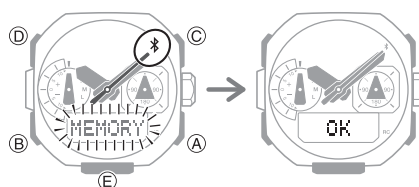

- Perform the operation shown on the phone screen to view the Location Memory information record.
 - You can have only one location record in memory. Saving location information while there is already a location record in memory will overwrite the existing record with the new information.

Note

- You can use the CASIO WATCHES phone app to change the information recorded in Location Memory to something else. Note that this operation is not supported while the watch is being used inside of China.
- If there is location information stored in Location Memory, you can use Location Indicator to check the distance and bearing to the stored location.
[Checking the Distance and Bearing to a Location Memory Point \(Location Indicator\)](#)

Checking the Distance and Bearing to a Location Memory Point (Location Indicator)

The watch acquires current location information from the phone, and then displays the bearing and distance from your current location to the location recorded in Location Memory.

[Recording Your Current Location \(Location Memory\)](#)

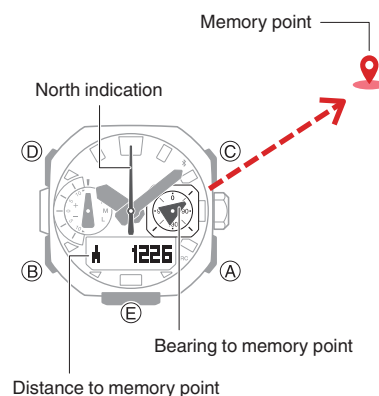

Important!

- Note that CASIO WATCHES operation is disabled while Location Indicator is in use.

- Tap the "CASIO WATCHES" icon.
- Enter the Compass Mode.
[Navigating Between Modes](#)
- Hold down (C) for at least two seconds. Release the button when [INDICATE] starts to flash, and the second hand points to .

When a location information receive operation is successful while the watch is connected with a phone, [INDICATE] will change to [OK].

After two seconds, the distance from your current location to the recorded location appears on the display, and the bearing hand indicates the bearing to the destination.

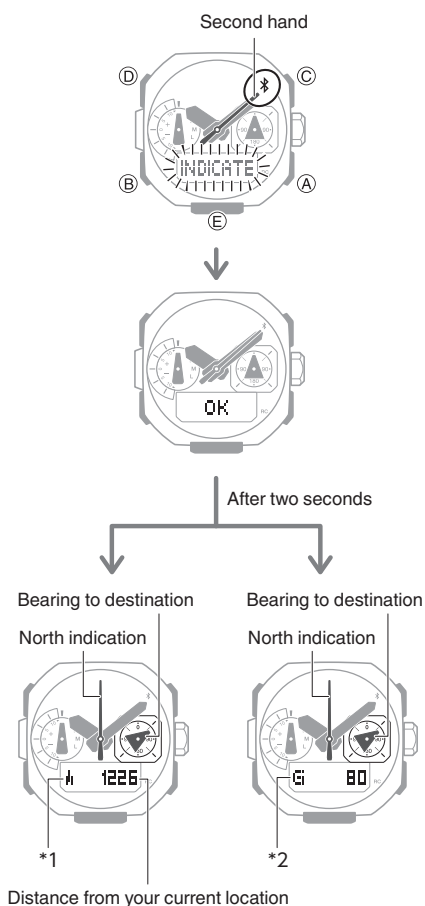

*1

[] starts to flash on the display when the bearing hand indication is within 30 degrees of the bearing to the destination.

*2

[G] is shown on the display when you are within 80 meters of the destination. [G] will disappear from the display if you move to a distance of 161 meters or more from the destination.

4. Check the display distance and the bearing to your destination on the display.

Note

- Location Indicator remains enabled for three minutes.
- The watch connects with the phone and acquires location information every 10 seconds or each time (C) is pressed, and uses the acquired information to refresh the distance and the bearing up to the point stored in Location Memory.
- Location Indicator will become disabled automatically about three minutes after it is enabled. You can also disable it manually by pressing any button besides (C) or (E).
- Pressing (C) or (E) while Location Indicator is enabled causes it to remain enabled for three minutes after the button is pressed.
- Pressing (C) to update data causes [] TRY] to appear on the display and remain displayed until data updating is complete.
- [] FAIL] will appear on the display in the cases below.
 - When it has been 30 seconds or more since the last update and location information acquisition fails
 - When it has been 60 seconds or more since the last update
 - When data update fails after you press (C)
- The display range for the distance to a destination is 0 to 99,999 meters (0 to 327,995 feet). [] -----] will be shown for the distance to the destination when it is outside the display range.
- [ERR] will appear on the display if connection fails for some reason.
- The message [NO-DATA] will appear when there is no data in Location Memory.
- [FAILED] → [POSITION] will appear in sequence if the first location information acquisition fails.
- [] or [G] will flash on the display if the watch detects abnormal magnetism while Location Indicator is in use.
- [] ERR] will appear on the display if a direction sensor error occurs while Location Indicator is in use.

Auto Altitude Calibration

Enabling auto altitude calibration with CASIO WATCHES will cause altitude values to be acquired by CASIO WATCHES, which will be used to automatically correct the watch's altitude reading.

Important!

- Use CASIO WATCHES to enable or disable auto altitude calibration. It cannot be enabled or disabled on the watch.

Note

- If an altitude value acquired by CASIO WATCHES satisfies accuracy conditions, the watch will automatically correct its altitude reading.
- Auto altitude calibration is performed at the same time as auto time correction.
- Auto altitude calibration is not performed for 12 hours after the time setting is adjusted manually.

Recording Waypoints and Their Altitudes (Route Log)

Route Log uses CASIO WATCHES GPS to record the waypoints of your routes. At the same time, the watch takes altitude readings every two minutes and stores them in memory, and automatically transfers altitude data to CASIO WATCHES every hour.

1. Tap the "CASIO WATCHES" icon.
2. Enter the Altimeter Mode.
[Navigating Between Modes](#)
3. Hold down (A) for at least five seconds. Release the button after [LOG] starts to flash, and the second hand moves to .

When a connection between the watch and phone is established, [LOG] will change to [LOG ON].

- This indicates that Route Log is enabled.

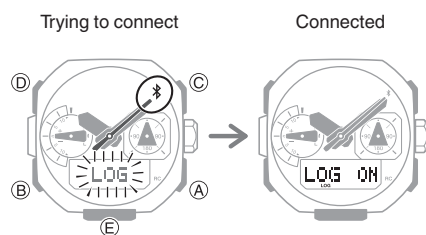

- To disable Route Log, hold down (A) again for at least five seconds.

Note

- [LOG] is displayed while Route Log is enabled.
- Route Log becomes disabled automatically 12 hours after it is enabled.
- Route Log remains enabled even if you change to another mode.
- The watch has enough memory to hold up to 60 altitude records. Recording data when there are already 60 records in memory will automatically delete the oldest record to make room for the new one.

Data Transfer

After Route Log is enabled, data transfer starts when the number of altitude records in watch memory reaches 30.

- Auto data transfer is performed during the normal state of each mode.

The display cycles as shown below as data is being transferred.

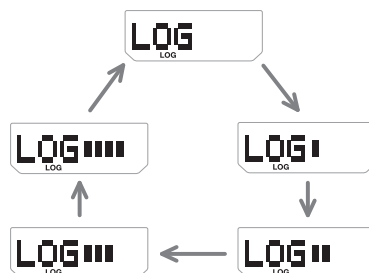

- The second hand will point to [RC].
- If data transfer fails for some reason, the watch will return to the previous screen with [LOG] flashing.



Note

- If auto transfer fails for some reason, the watch will keep trying up to five times at 10-minute intervals. Or data is transferred when a CASIO WATCHES connection is established.

Configuring World Time Settings

Specifying a World Time City with the CASIO WATCHES phone app causes the watch's World Time City to change accordingly. Settings can be configured to perform auto summer time switching for the World Time City.



Note

- The CASIO WATCHES phone app World Time lets you select from among approximately 300 cities as the World Time City.
- You can use the CASIO WATCHES phone app to configure settings for user cities that are not included in the watch's built-in World Time Cities. You must use the CASIO WATCHES phone app to select a user city as your World Time City.

To select a World Time City

1. Tap the "CASIO WATCHES" icon.
2. Hold down (B) for at least five seconds. Release the button when the second hand points to , and [CNCT] flashes on the display.

When a connection is established between the watch and phone, [CNCT] will stop flashing.

- If connection fails for some reason, [ERR] will appear on the display momentarily and then the watch will return to the Timekeeping Mode.

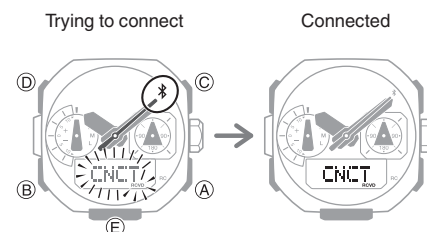

3. Perform the operation shown on the phone screen. The World Time setting will be reflected on the watch.

● Configuring the Summer Time Setting

1. Tap the “CASIO WATCHES” icon.
2. Hold down (B) for at least five seconds. Release the button when the second hand points to , and [CNCT] flashes on the display.

When a connection is established between the watch and phone, [CNCT] will stop flashing.

- If connection fails for some reason, [ERR] will appear on the display momentarily and then the watch will return to the Timekeeping Mode.

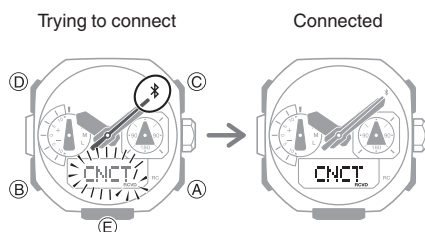

3. Perform the operation shown on the phone screen to select a summer time setting.
 - “Auto”
The watch switches between standard time and summer time automatically.
 - “OFF”
The watch always indicates standard time.
 - “ON”
The watch always indicates summer time.

Note

- While the summer time setting is “Auto”, the watch switches between standard time and summer time automatically. You do not need to switch between standard time and summer time manually. Even if you are in an area that does not observe summer time, you can leave the watch’s summer time setting as “Auto”.
- Changing the time setting manually with a watch operation will cancel auto standard time/summer time switching.
- For information about summer time periods, refer to the “Summer Time Table”.

● Swapping Your World Time and Home Time

1. Tap the “CASIO WATCHES” icon.
2. Hold down (B) for at least five seconds. Release the button when the second hand points to , and [CNCT] flashes on the display.

When a connection is established between the watch and phone, [CNCT] will stop flashing.

- If connection fails for some reason, [ERR] will appear on the display momentarily and then the watch will return to the Timekeeping Mode.

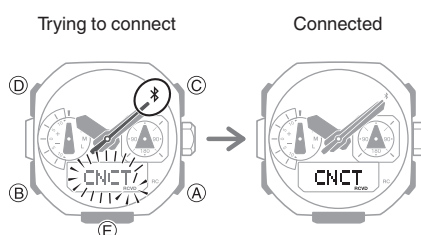

3. Perform the operation shown on the phone screen to swap your Home Time with your World Time.

Note

- Auto time correction does not work for 24 hours after swapping the Home Time and World Time.

Adjusting Hand Alignment

If the hands are out of alignment even though auto time correction is being performed, you can use the CASIO WATCHES phone app to adjust them.

1. Tap the “CASIO WATCHES” icon.
2. Hold down (B) for at least five seconds. Release the button when the second hand points to , and [CNCT] flashes on the display.

When a connection is established between the watch and phone, [CNCT] will stop flashing.

- If connection fails for some reason, [ERR] will appear on the display momentarily and then the watch will return to the mode it was in before you started the connection procedure.

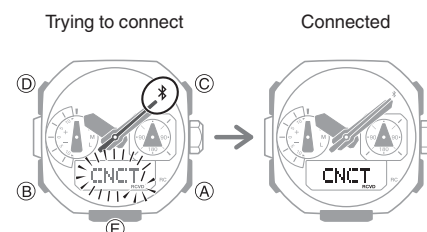

3. Perform the operation shown on the phone screen to correct hand alignment.

Phone Finder

You can use phone finder to trigger a tone on the phone to make it easy to find. The tone is forced to sound even if the phone is in vibrate mode.

Important!

- Do not use this function in areas where phone call tones are restricted.
- The tone sounds at a high volume. Do not use this function when listening to phone output over earphones.

1. If the watch is connected with a phone, press any button to terminate the connection.

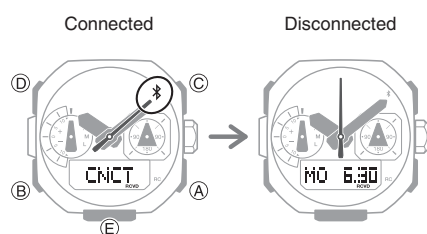

2. Enter the Receive Mode.
[Navigating Between Modes](#)

3. Hold down (A) for at least five seconds. Release the button when [FIND] starts to flash.

The phone sounds a tone when it establishes a connection with the watch.

- It takes a few seconds before the phone tone sounds.

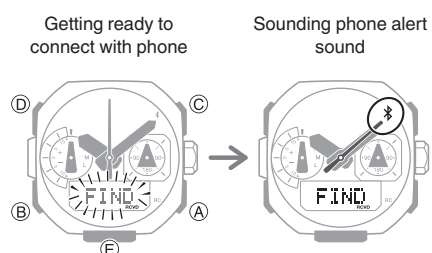

4. Press any button to stop the tone.
 - You can press any watch button to stop the phone tone only during the first 30 seconds after it starts to sound.

Configuring Watch Settings

Alarm time, timer start time, and other settings can also be configured using the CASIO WATCHES phone app.

1. Tap the "CASIO WATCHES" icon.
2. Hold down (B) for at least five seconds. Release the button when the second hand points to , and [CNCT] flashes on the display.

When a connection is established between the watch and phone, [CNCT] will stop flashing.

- If connection fails for some reason, [ERR] will appear on the display momentarily and then the watch will return to the Timekeeping Mode.

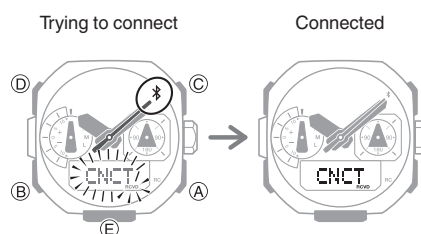

3. Select the setting you want to change and then perform the operation shown on the phone screen.

Changing the Home City Summer Time Setting

1. Tap the "CASIO WATCHES" icon.
2. Hold down (B) for at least five seconds. Release the button when the second hand points to , and [CNCT] flashes on the display.

When a connection is established between the watch and phone, [CNCT] will stop flashing.

- If connection fails for some reason, [ERR] will appear on the display momentarily and then the watch will return to the Timekeeping Mode.

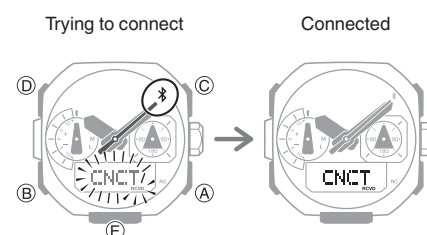

3. Perform the operation shown on the phone screen to change your Home City summer time setting.

Checking the Watch Charge Level

Use the procedure below to check the current charge level with CASIO WATCHES.

1. Tap the "CASIO WATCHES" icon.
2. Hold down (B) for at least five seconds. Release the button when the second hand points to , and [CNCT] flashes on the display.

When a connection is established between the watch and phone, [CNCT] will stop flashing.

- If connection fails for some reason, [ERR] will appear on the display momentarily and then the watch will return to the Timekeeping Mode.

Trying to connect

Connected

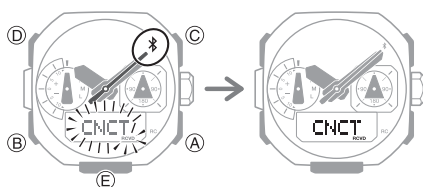

3. Use CASIO WATCHES to check the charge level.

Recording Your Current Location (TIME&PLACE)

While traveling or otherwise on the go, you can use the procedure below to record your current location, along with the time and date, on your phone. Recorded location information can be viewed on the CASIO WATCHES phone app map.

Recording Your Current Location

1. Enter the Receive Mode.
[Navigating Between Modes](#)
2. When you are in the location you want to record, press (A).
 This records, in phone memory, your latitude and longitude and the current date and time, and displays [OK] on the watch.
 • At this time the time settings of your phone and watch are synced with each other.

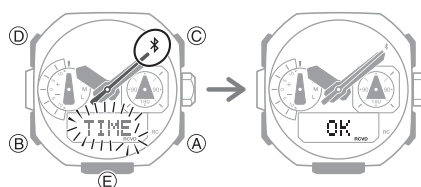

Viewing a Recorded Location on a Map

1. Tap the "CASIO WATCHES" icon.
2. Perform the operation shown on the phone screen to view recorded location information.

Note

- You can use the CASIO WATCHES phone app to delete recorded location information.

Connection

Connecting with a Phone

Your watch can connect with a phone that is paired with it.

- If the watch is not paired with the phone you want to connect with, refer to the information below and pair them.

 [Pair the watch with a phone.](#)

Connecting with a Phone

1. Move the phone close to (within one meter of) the watch.
2. Hold down (B) for at least five seconds. Release the button when the second hand points to , and [CNCT] flashes on the display.

When a connection is established between the watch and phone, [CNCT] will stop flashing.

- If connection fails for some reason, [ERR] will appear on the display momentarily and then the watch will return to the Timekeeping Mode.

Trying to connect

Connected

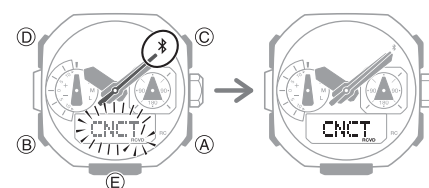

Important!

- If you have problems establishing a connection, it could mean that the CASIO WATCHES phone app is not running on your phone. On your phone's home screen, tap the "CASIO WATCHES" icon. After the app starts up, hold down the watch's (B) button for at least five seconds.

Note

- The connection is terminated if you do not perform any operation on the watch or phone for a fixed amount of time. To specify the connection limit time, perform the following operation with the CASIO WATCHES phone app: "Watch settings" → "Connection time with the app". Next, select a setting of 3 minutes, 5 minutes, or 10 minutes.

Disconnecting the Watch from a Phone

Pressing any button terminates a Bluetooth connection and return to the Timekeeping Mode.

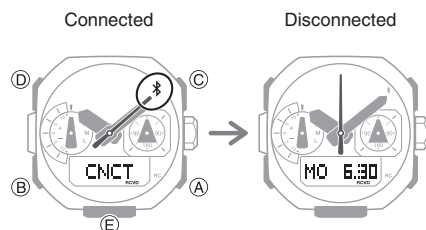

Unpairing the Watch from a Phone

Unpairing the watch from a phone requires both the CASIO WATCHES phone app and watch operations.

Deleting Pairing Information from the CASIO WATCHES phone app

1. Tap the "CASIO WATCHES" icon.
2. Perform the operation shown on the phone screen to unpair.

Deleting Pairing Information from the Watch

1. Hold down (B) for at least two seconds to enter the Timekeeping Mode.
2. Loosen the crown and then pull it out. The currently selected Home City will appear on the display.

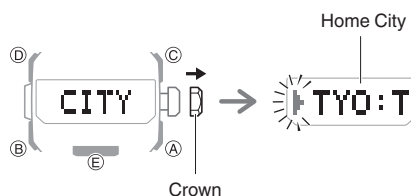

3. Hold down (D) for at least three seconds. This, at first, causes [PAIR] and [CLEAR] to alternate on the display. Release the button when only [CLEAR] is displayed.

This deletes the pairing information from the watch and returns to the timekeeping display.

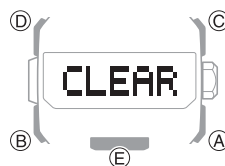

4. Push the crown back in and then lock it. This returns the watch to the Timekeeping Mode.

Important!

- Pairing information cannot be deleted from watch memory while Route Log is enabled.
 - 🔗 [Recording Waypoints and Their Altitudes \(Route Log\)](#)

If you purchase another phone

You need to perform the pairing operation whenever you want to establish a Bluetooth connection with a phone for the first time.

🔗 [Deleting Pairing Information from the Watch](#)

- 🔗 ③ [Pair the watch with a phone.](#)

Time Correction

Your watch can obtain date and time information by connecting with a phone and by receiving time signals, which it uses to adjust its settings.

Important!

- When you are on an aircraft or in any other location where radio signals may cause problems, enable the watch's Airplane Mode to disable connection with your phone.
 - 🔗 [Using the Watch in a Medical Facility or Aircraft](#)

Referring to the information below, configure the time setting in accordance with the method that suits your own lifestyle.

Do you use a phone?

Time correction by connecting with your phone is recommended.

[Auto Time Correction](#)

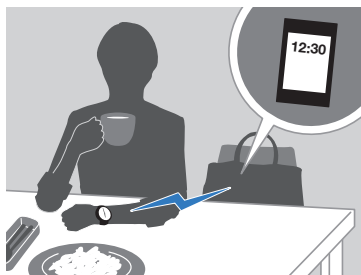

Can you receive a time signal in your area?

While the watch's Home Time City setting is one where a time signal can be received, the watch's time and day settings can be adjusted in accordance with the signal.

[Time Signal Reception Ranges](#)

[Setting a Home City](#)

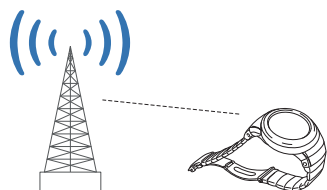

Other than the above.

If you are unable to connect with a phone and are unable to receive a time signal, you can perform watch button operations to adjust its time setting.

[Using Watch Operations to Adjust the Time Setting](#)



Time Adjustment Using a Time Signal

Overview

The watch's time and day settings can be configured in accordance with a received time calibration signal.

Important!

- In order to make it possible for the current time setting to be adjusted correctly based on time calibration signal reception, you need to specify the time zone where you are using the watch.
- If the watch was unable to connect with a phone even once for time correction during the previous day while connection with a phone is being used, it will automatically try to receive a time calibration signal.

Note

- Areas where time calibration signal reception is supported are limited. When the watch is in an area where time calibration signal reception is not possible, connect with a phone to adjust time and day settings.
- [Time Signal Reception Ranges](#)

Appropriate Signal Reception Location

A time calibration signal can be received while the watch is near a window.

- Position the watch so its 12 o'clock side is facing the window.
- Keep metal objects away from the watch.
- Do not move the watch.
- Do not perform any operation on the watch.

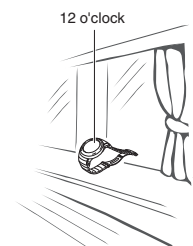

Note

- You may experience time calibration signal reception problems in the areas described below.
 - Among or near buildings
 - While riding in a vehicle
 - Near household appliances, office machines, mobile phones, etc.
 - On a construction site, in an airport, or any other location where radio wave interference occurs
 - Near high-voltage lines
 - In mountainous areas or behind a mountain

Time Signal Reception Ranges

● Japan (JJY)

The Japan time signal radio stations are located on Mt. Otakadoya in Fukushima and Mt. Hagane in Fukuoka/Saga.

The reception range of the Japanese time signals is approximately 1,000 km from each transmission station.

● China (BPC)

The China time signal radio station is located in Shangqiu, Henan Province, China.

The reception range of the Chinese time signal is approximately 1,500 km from the transmission station.

● United States (WWVB)

The United States time signal radio station is located in Fort Collins, Colorado.

The reception range of the U.S. time signal is approximately 3,000 km from the transmission station.

● U.K. (MSF)/Germany (DCF77)

The U.K. time signal radio station is located in Anthorn, Cumbria.

The German time signal radio station is located in Mainflingen, southeast of Frankfurt. The reception range of the U.K. and German time signals is approximately 1,500 km from each transmission station.

Note

- Even if you are within the normal reception range of a time calibration signal, reception may be made impossible by the following factors: geographic contours, weather, the season, the time of day, wireless noise.
- A time calibration signal cannot be received while the city selected as your Home City is one that does not support signal reception.

Auto Time Calibration Signal Receive

An automatic time calibration signal receive operation is performed and the time and day settings are corrected between midnight and 5:00 a.m. Once a signal receive operation is successful, no more auto receive operations are performed that day.

1. Place the watch near a window or some other location appropriate for signal reception.
 - [RC!] is shown on the display while time signal reception is in progress.
 - When a receive operation is successful, the watch adjusts its current time and day settings automatically, and then returns to the Timekeeping Mode.

Note

- Reception takes anywhere from about two minutes to about 10 minutes. It can take as long as 20 minutes.

Enabling and disabling Auto Receive

You can stop auto receive by disabling the Auto Receive setting.

Note

- While the Home City setting is one where time signal reception is possible, you can enable or disable auto receive as required.
 - 🔗 [Time Signal Reception Ranges](#)

1. Enter the Receive Mode.
 - 🔗 [Navigating Between Modes](#)
2. Loosen the crown and then pull it out. [AUTORC] appears on the display with [ON] or [OFF] flashing.

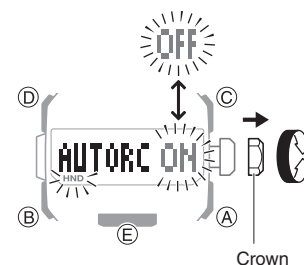

3. Rotate the crown to enable or disable Auto Receive.
4. Push the crown back in and then lock it.

Note

- If you do not perform any operation for about two minutes after pulling out the crown, crown operations will automatically become disabled. If that happens, push the crown back in and then pull it out again.

Manual Time Calibration Signal Receive

1. Place the watch near a window or some other location appropriate for time signal reception.
2. Enter the Receive Mode.
[🔍 Navigating Between Modes](#)
3. Hold down (A) for at least two seconds until [RC !] appears on the display.

This indicates that the receive operation has started. After the receive operation is complete, the watch's time and day settings will be corrected accordingly.

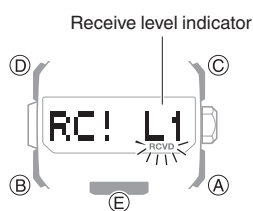

- The level indicator shows the signal level ([L1], [L2], [L3]) while a receive operation is in progress.

[🔍 Receive Level Indicator](#)

Note

- The receive operation takes anywhere from about two minutes to about 10 minutes. It can take as long as 20 minutes.
- Time calibration signal reception is better at night than during the day.

Receive Level Indicator

While a receive operation is in progress, its current status is indicated on the display as shown below. Use the level indicator to find a location where signal reception is stable.

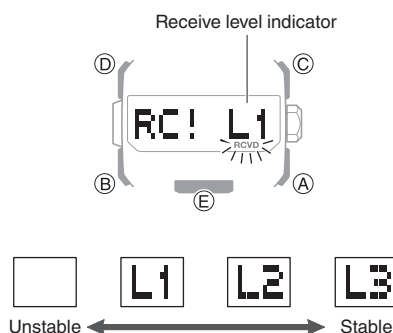

Note

- It takes about 10 seconds for time signal reception conditions to stabilize.
- Reception conditions are affected by weather, the time of day, the surrounding environment, etc.

Checking the Last Time Adjustment Result

1. Enter the Receive Mode.
[🔍 Navigating Between Modes](#)

This displays the date and time of the last successful receive operation.

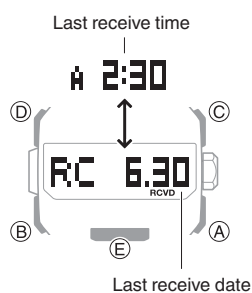

Signal Reception Precautions

- When the watch is unable to correct its time in accordance with a calibration signal for some reason, average timekeeping accuracy is within ± 15 seconds per month.
- Note that an internal decoding process the watch performs after it receives a signal may cause the time setting to be slightly off (by less than one second).
- Time calibration signal reception is not possible under the conditions described below.
 - While battery power is low
 - While in any mode besides the Timekeeping Mode
 - When the watch is at Level 2 power saving
 - While a compass reading, barometric pressure measurement, temperature measurement, or altitude measurement operation is in progress
 - While the barometric pressure change indication is enabled
 - While a timer countdown operation is in progress
 - While auto time correction is disabled
 - While the Home City area setting is one where time signal reception is not possible
 - While the watch is outside the time signal reception range
- When the receive operation is successful, the time and/or day settings will be corrected automatically. Summer time will not be applied correctly in the case described below.
 - When the summer time start date and time, end date and time, or other rules are changed by authorities

Using Watch Operations to Adjust the Time Setting

If your watch cannot connect with a phone for some reason, you can use watch operations to adjust date and time settings.

● Setting a Home City

Use the procedure in this section to select a city to use as your Home City. If you are in an area that observes summer time, you can also enable or disable summer time.

1. Enter the Timekeeping Mode.
[🔗 Navigating Between Modes](#)

2. Loosen the crown and then pull it out.
The currently selected Home City will appear on the display.

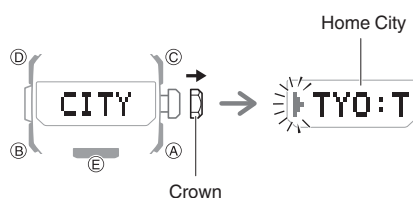

3. Rotate the crown to display the city you want to use.
 - For information about city codes, refer to the information below.
[🔗 City Table](#)
4. Press (B).

5. Rotate the crown to select a summer time setting.

Rotating the crown cycles through the setting items shown below.

- [AUTO]
The watch switches between standard time and summer time automatically.
- [OFF]
The watch always indicates standard time.
- [ON]
The watch always indicates summer time.

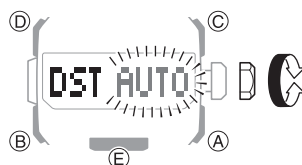

6. Push the crown back in and then lock it.

Note

- If you do not perform any operation for about two minutes after pulling out the crown, crown operations will automatically become disabled. If that happens, push the crown back in and then pull it out again.
- The [AUTO] summer time setting is valid when the watch's Home City is in an area where a time signal can be received.

● Setting the Time/Date

1. Enter the Timekeeping Mode.
[🔗 Navigating Between Modes](#)
2. Loosen the crown and then pull it out.
The currently selected Home City will appear on the display.

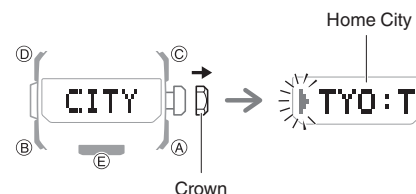

3. Press (D).
This causes the hours and minutes digits to flash.

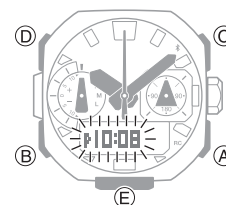

4. Rotate the crown to change the minute setting.
 - The hour digit changes in sync with the minute digit change.
5. Press (B).
This causes the hours digits to flash.
6. Rotate the crown to change the hour setting.
7. Press (B).
This causes the current year setting to flash on the display.

- Rotate the crown to change the year setting.

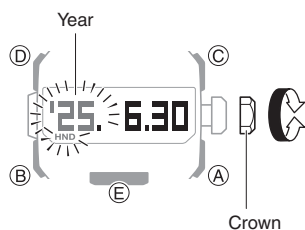

- Press (B).

This causes the month to flash on the display.

- Rotate the crown to change the month.

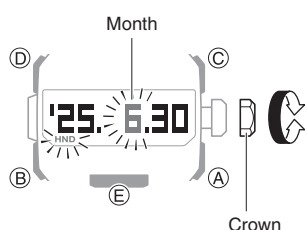

- Press (B).

This causes the day to flash on the display.

- Rotate the crown to change the day.

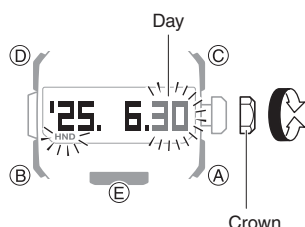

- On a time signal at the top of a minute, push the crown back in and lock it.

Note

- If you do not perform any operation for about two minutes after pulling out the crown, crown operations will automatically become disabled. If that happens, push the crown back in and then pull it out again.

● Switching between 12-hour and 24-hour Timekeeping

You can specify either 12-hour format or 24-hour format for the time display.

- Enter the Timekeeping Mode.
[Navigating Between Modes](#)

- Loosen the crown and then pull it out.

The currently selected Home City will appear on the display.

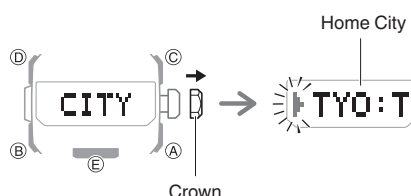

- Press (B) five times.

This causes [12H] or [24H] to flash on the display.

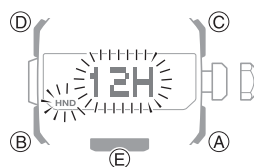

- Rotate the crown to select [12H] (12-hour timekeeping) or [24H] (24-hour timekeeping).

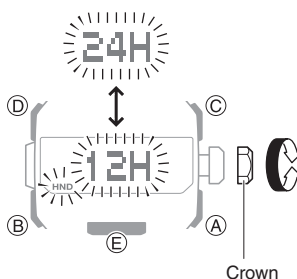

- Push the crown back in and then lock it.

Note

- If you do not perform any operation for about two minutes after pulling out the crown, crown operations will automatically become disabled. If that happens, push the crown back in and then pull it out again.

Using the Watch in a Medical Facility or Aircraft

Whenever you are in a hospital, on an aircraft, or in any other location where auto time calibration signal receive or connection with a phone may cause problems, you can perform the procedure below to disable auto time correction. To re-enable auto time correction, perform the same operation again.

- Enter the Receive Mode.

[Navigating Between Modes](#)

- Loosen the crown and then pull it out.

[AUTORC] appears on the display with [ON] or [OFF] flashing.

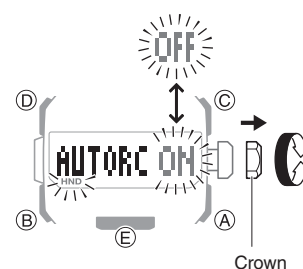

- Rotate the crown to change the auto time correction setting.

[OFF]: Auto time correction disabled.

[ON]: Auto time correction enabled.

- Push the crown back in and then lock it.

World Time

You can view the current time in 55 cities (38 time zones), and UTC (Coordinated Universal Time) time.



Using the CASIO WATCHES Phone App to Configure World Time City Settings

If the watch is paired with a phone, you can also use the CASIO WATCHES phone app to set the World Time city.

[Configuring World Time Settings](#)

Note

- World Time cities that can be selected only by using the CASIO WATCHES phone app cannot be selected using watch operations.

Checking World Time

- Enter the World Time Mode.
[Navigating Between Modes](#)

After the currently selected World Time City name appears, the watch will display the current time in that city.

- The hour and minute hands will indicate the current Home City time.

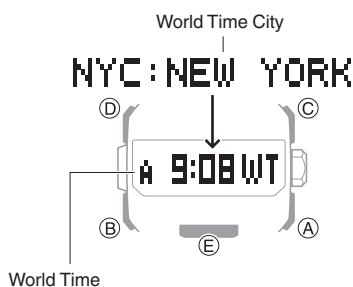

Setting the World Time City

Use the procedure in this section to select a World Time city. If you are in an area that observes summer time, you can also enable or disable summer time.

- Enter the World Time Mode.
[Navigating Between Modes](#)
- Loosen the crown and then pull it out. This displays the currently selected World Time City.

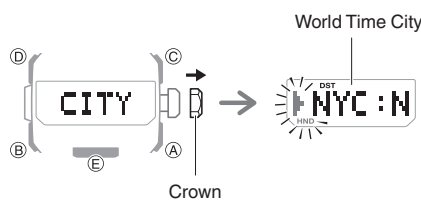

- Rotate the crown to display the city you want to use.
 - For information about city codes, refer to the information below.
[City Table](#)
- Press (B).
- Rotate the crown to select a summer time setting.

Rotating the crown cycles through the setting items shown below.

- [AUTO] The watch switches between standard time and summer time automatically.
- [OFF] The watch always indicates standard time.
- [ON] The watch always indicates summer time.

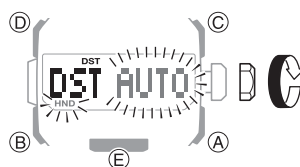

- Push the crown back in and then lock it.

Note

- If you do not perform any operation for about two minutes after pulling out the crown, crown operations will automatically become disabled. If that happens, push the crown back in and then pull it out again.
- While [UTC] is selected as the city, you will not be able to change or check the summer time setting.

Specifying UTC (Coordinated Universal Time) as Your World Time City

To set UTC (Coordinated Universal Time) as your World Time City, enter the World Time Mode and then hold down (A) for at least three seconds.

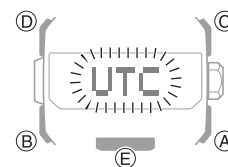

Swapping Your Home Time and World Time

In the World Time mode, hold down (D) for at least three seconds. [CITY] will appear on the display, and your Home City time will be swapped with your World Time.

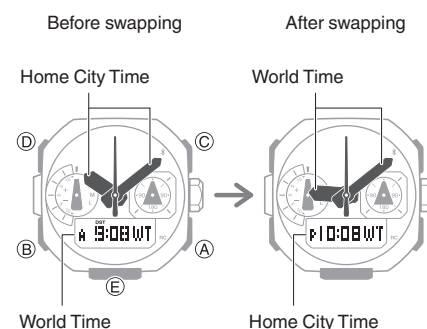

Moving Between Time Zones

Use the procedure below to easily change day and time settings of the watch to a destination location.

● Before Boarding

1. Configure the World Time to the current time at your destination.

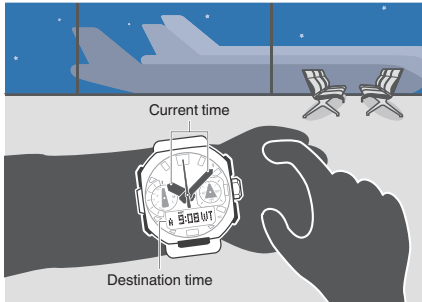

- 🔍 Using CASIO WATCHES to Configure Settings
- 🔍 Using Watch Operations to Configure Settings

2. Disable auto time correction.

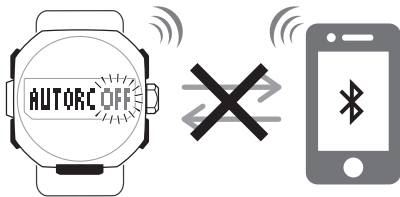

- 🔍 Using the Watch in a Medical Facility or Aircraft

● After Arriving

1. Swap the origin time zone time with the destination time zone time.

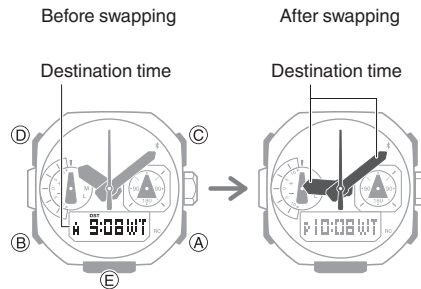

- 🔍 Using CASIO WATCHES to Configure Settings
- 🔍 Using Watch Operations to Configure Settings

2. Disable auto time correction.
 - 🔍 Using the Watch in a Medical Facility or Aircraft
3. Correct the time setting.
 - 🔍 Triggering Immediate Time Correction

Alarm

The watch beeps when an alarm time is reached. You can set up to five different alarms. The hourly time signal causes the watch to beep every hour on the hour.

- The beeper will not sound if battery power is low.



Using the CASIO WATCHES Phone App to Configure Alarm Settings

If the watch is paired with a phone, you can also use the CASIO WATCHES phone app to set alarms.

- 🔍 [Configuring Watch Settings](#)

Configuring Alarm Settings

1. Enter the Alarm Mode.
 - 🔍 [Navigating Between Modes](#)
2. Use (A) and (C) to select the alarm number ([AL1] to [AL5]) whose setting you want to change.

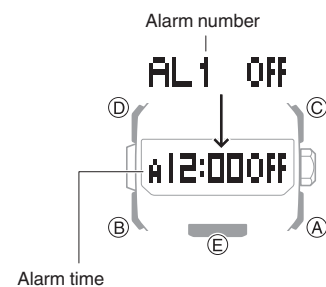

- Loosen the crown and then pull it out.
This causes the hours and minutes digits to flash.

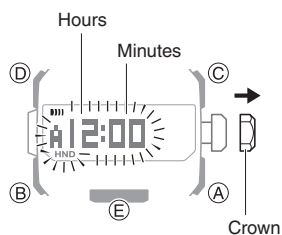

- Rotate the crown to change the minute setting.
 - The hour digit changes in sync with the minute digit change.
- Press (B).
This causes the hours digits to flash.

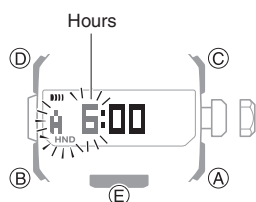

- Rotate the crown to change the hour setting.
 - If you are using 12-hour timekeeping, the time setting is indicated as [A] (a.m.) or [P] (p.m.).

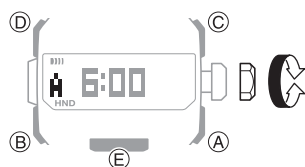

- Push the crown back in and then lock it.

Note

- If you do not perform any operation for about three minutes while in the Alarm mode, the watch automatically returns to the Timekeeping Mode.
- If you do not perform any operation for about two minutes after pulling out the crown, crown operations will automatically become disabled. If that happens, push the crown back in and then pull it out again.

To stop the alarm

To stop the alarm after it starts to sound when an alarm time is reached, press any button.

Note

- A beeper sounds for 20 seconds when an alarm time is reached.

Enabling the Hourly Time Signal

- Enter the Alarm Mode.
[Navigating Between Modes](#)
- Press (A) or (C) to display the hourly time signal screen ([SIG]).



- Press (D) to toggle the hourly time signal between enabled and disabled.

- (hourly time signal) is shown on the display while the hourly time signal is enabled.

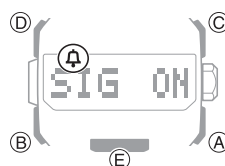

Turning Off an Alarm or the Hourly Time Signal

To stop an alarm or the hourly time signal from sounding, perform the steps below to turn it off.

- To have an alarm or hourly time signal sound again, turn it back on.

Note

- Indicators are displayed while any of the alarms or the hourly time signal is turned on.
- The applicable indicators are not displayed while all of the alarms are turned off and/or the hourly time signal is turned off.

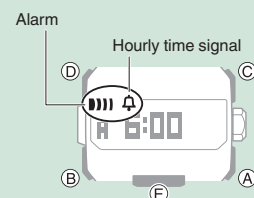

- Enter the Alarm Mode.
[Navigating Between Modes](#)
- Use (A) and (C) to scroll through the alarm number ([AL1] to [AL5]) and hourly time signal ([SIG]) screens until the one you want to turn off is displayed.

Alarm number or hourly time signal

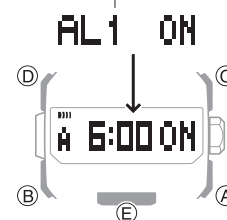

3. Press (D) to turn off the displayed alarm or the hourly time signal.

- Each press of (D) toggles between on and off.
- Turning off all alarms will cause **||||** (alarm) to disappear from the display, while disabling the hourly time signal causes **🔔** (hourly time signal) to disappear from the display.

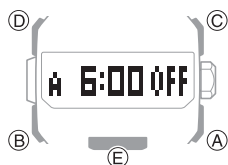

Note

- If **||||** (alarm) is still displayed, it means that another alarm is still turned on. To turn off all of the alarms, repeat steps 2 and 3 until the **||||** (alarm) indicator is no longer displayed.

Digital Compass

You can use the Compass Mode to determine the direction of north, and to check your bearing to a destination.



Important!

- Check the information at the link below to find out how to ensure correct readings.
 - 🔗 [Calibrating Compass Readings](#)
 - 🔗 [Digital Compass Reading Precautions](#)

Taking a Compass Reading

1. Enter the Compass Mode.
 - 🔗 [Navigating Between Modes](#)

This displays [COMP] and starts digital compass readings.
2. Keeping the watch level, point 12 o'clock in the direction of your desired objective.
 - The second hand points North. The digital display shows one of 16 literal direction indications or the bearing angle.
 - To retrigger the compass operation, press (C).

Interpreting Bearing Readings

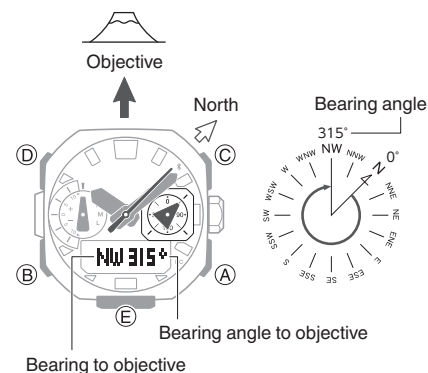

Directions: N (North), E (East), W (West), S (South)

Note

- Normally the compass indicates magnetic north. You can also configure settings to indicate true north.
 - 🔗 [Setting Up for True North Readings \(Magnetic Declination Calibration\)](#)
 - 🔗 [Magnetic North and True North](#)
- After the initial reading is displayed, the watch will continue to take readings about every second for about the next 60 seconds. The watch will return to the Timekeeping Mode automatically about 60 seconds after you press (C).
- Full Auto Light will not illuminate the face while a compass operation is in progress.
- If an alarm or other beeper sounds, or if you turn on illumination by pressing (E) while a compass operation is in progress, the compass operation will be suspended momentarily. The compass operation will resume when the beeper stops, or illumination turns off.
- You can use CASIO WATCHES to record location information and then use the watch to display the distance and bearing to the recorded location.
 - 🔗 [Recording Your Current Location \(Location Memory\)](#)
 - 🔗 [Checking the Distance and Bearing to a Location Memory Point \(Location Indicator\)](#)

● Aligning a Map with Actual Surroundings (Setting a Map)

Setting a map means to align the map so the directions indicated on it are aligned with the actual directions of your location. Once you set a map, you can more easily get a grasp of the relationship between map markings and actual geographic contours. To set a map with this watch, align north on the map with the north indication of the watch. Once you set the map, you can compare your bearing on the map with your surroundings, which will help you determine your current location and destination.

- Note that map reading skills and experience are required to determine your current location and destination on a map.

Saving a Bearing to a Destination (Bearing Memory)

You can record the bearing to a destination. The recorded bearing is indicated by the bearing hand. This makes it possible for you to progress towards a target destination even when visibility is poor.

1. Enter the Compass Mode.
[🔗 Navigating Between Modes](#)

2. Keeping the watch horizontal, point 12 o'clock in the direction of the objective you want to record.

3. Press (D).

The direction of the 12 o'clock position of the watch is recorded as the destination direction.

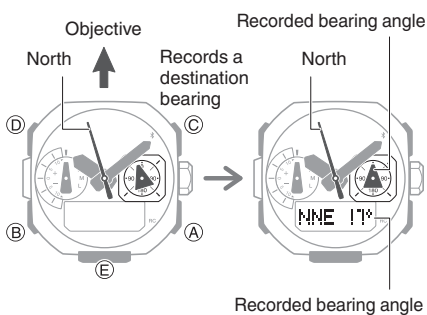

- To clear a recorded bearing, hold down (D) for at least two seconds.

Calibrating Compass Readings

Calibrating Compass Readings

Perform figure 8 or three-point calibration whenever you notice the watch's compass readings differ from those of another compass or before setting out on a climb or trek.

- Note that accurate compass readings and/or calibration will not be possible in an area where strong magnetism is present.
[🔗 Digital Compass Reading Precautions](#)

Figure 8 calibration

1. Enter the Compass Mode.

[🔗 Navigating Between Modes](#)

2. Loosen the crown and then pull it out.

This displays ∞.

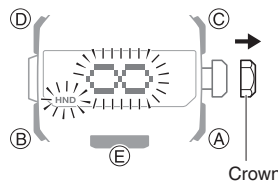

3. Press (C).

Move your arm in a figure 8 pattern as shown in the illustrations below.

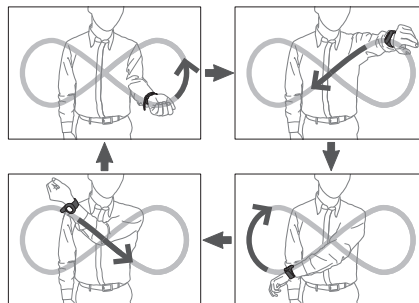

- Allow your wrist to twist.
- Keep your arm as far as possible from your body as you move it.
- The ∞ symbol will stop flashing on the display while calibration is in progress.
- When the calibration operation is successful, [OK] will appear on the display.

Note

- If calibration fails, the watch returns to its state in step 2 of this procedure. Perform the steps again starting from step 3.

4. Push the crown back in and then lock it.

3-Point Calibration

1. Enter the Compass Mode.

[🔗 Navigating Between Modes](#)

2. Loosen the crown and then pull it out.

This displays ∞.

3. Press (B).

This displays [↑ 1].

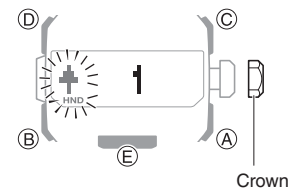

4. While keeping the watch horizontal, press (C).

This starts calibration of the first point, which causes [↑ WAIT] to appear on the display. When calibration is successful, indicators appear on the display in the following sequence: [OK] → [Turn 180°] → [↓ 2].

5. Rotate the watch 180 degrees, taking care to be as exact as possible.

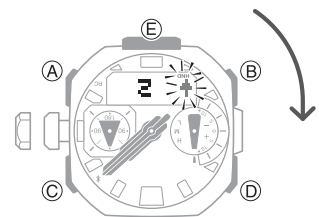

6. Press (C).

This starts calibration of the second point, which causes [↓ WAIT] to appear on the display. When the calibration operation is completed successfully, [OK] will appear, and then [TURN] and [OVER] will alternate on the display.

7. Turn the watch over so the LCD is pointing at the ground.

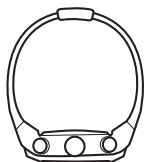

Ground

8. While keeping the watch horizontal, press (C).

This starts calibration of the third point, which causes [WAIT] to appear on the display. When the calibration operation is successful, [OK] will appear on the display.

9. Push the crown back in and then lock it.

Note

- If you do not perform any operation for about two minutes after pulling out the crown, crown operations will automatically become disabled. If that happens, push the crown back in and then pull it out again.
- If calibration fails, the watch returns to its state in step 2 of this procedure. If this happens, restart the above procedure from step 3.

Setting Up for True North Readings (Magnetic Declination Calibration)

If you want the watch to indicate true north instead of magnetic north, you need to specify your current location's magnetic declination direction (east or west) and declination angle.

Magnetic North and True North

- The magnetic declination angle value can be set in 1° (degree) units only. Use a value that is closest to the angle you want to set.
Example: For an angle of 7.4°, set 7°.
Example: For an angle of 7°40' (7 degrees, 40 minutes), set 8°.

Note

- Magnetic declination angles (east or west) and angle degree values for specific locations can be found on geographic maps, mountain climbing maps, and other maps that include contour lines.

1. Enter the Compass Mode.

Navigating Between Modes

2. Loosen the crown and then pull it out.

This displays ∞.

3. Press (B).

This displays [↑ 1].

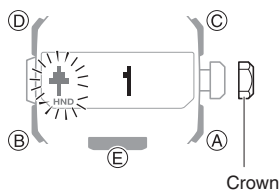

4. Press (B).

This displays [DEC] and the current magnetic declination setting.

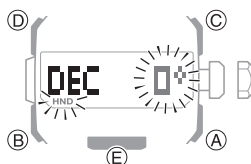

5. Rotate the crown to select a magnetic declination direction and angle settings as desired.

Setting range: 90° west to 90° east

[OFF]: Magnetic north

[E]: East declination (Magnetic north is east of true north.)

[W]: West declination (Magnetic north is west of true north.)

- To return the setting to [OFF], press (A) and (C) at the same time.

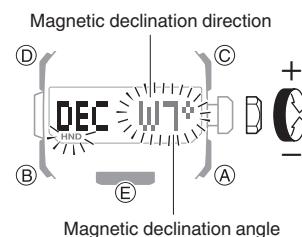

6. Push the crown back in and then lock it.

Note

- If you do not perform any operation for about two minutes after pulling out the crown, crown operations will automatically become disabled. If that happens, push the crown back in and then pull it out again.

Magnetic North and True North

There are actually two types of north: magnetic north and true north.

Magnetic north: North indicated by the needle of a compass

True north: Direction to the North Pole

As shown in the illustration below, magnetic north and true north are not the same.

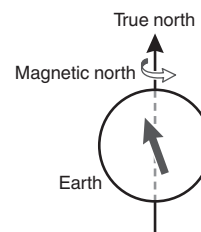

Note

- The north indicated on commercially available maps is normally true north.

Digital Compass Reading Precautions

Location During Use

Taking readings near sources of strong magnetism can cause reading error. Keep the watch away from the following types of items.

Permanent magnets (magnetic accessories, etc.), metal objects, high-voltage wires, aerial wires, electrical household appliances (TVs, computers, cellphones, etc.)

- Note that correct direction readings are not possible indoors, especially inside of reinforced concrete structures.
- Accurate direction readings are not possible on electric trains, on boats, on aircraft, etc.

Storage Location

Exposure of the watch to magnetism can affect the accuracy of digital compass readings. Keep the watch away from the types of items below.

Permanent magnets (magnetic accessories, etc.), metal objects, electrical household appliances (TVs, computers, cellphones, etc.)

Altitude Measurement

The watch takes altitude readings and displays results based on air pressure measurements taken by a built-in pressure sensor.



Important!

- The altitude readings displayed by the watch are relative values that are calculated based on barometric pressure measured by the watch's pressure sensor. This means that barometric pressure changes due to weather can cause altitude readings taken at the same location to be different. Also note that the value displayed by the watch may be different from the actual elevation and/or sea level elevation indicated for the area where you are located. When using the watch's altimeter while mountain climbing, it is recommended that you regularly calibrate its readings in accordance with local altitude (elevation) indications.
 - 🔗 [Calibrating Altitude Readings \(Offset\)](#)
- The altitude correction value you specify and/or barometric pressure changes may cause a negative value to be displayed.
- Check the information at the link below to find out about how to minimize differences between readings produced by the watch, and values provided by local altitude (elevation) indications.
 - 🔗 [Calibrating Altitude Readings \(Offset\)](#)
 - 🔗 [Altitude Reading Precautions](#)

Checking the Current Altitude

1. Enter the Altimeter Mode.

🔗 [Navigating Between Modes](#)

Entering the Altimeter Mode will start altitude measurement and display the altitude at your current location.

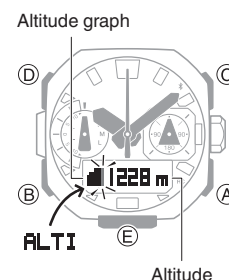

- The watch takes altitude readings every second for about the first three minutes. After that, it takes readings according to the watch's auto measurement interval setting.
- Check the information at the link below to find out how to configure the auto measurement interval.
 - 🔗 [Setting the Auto Measurement Interval](#)
- To retrigger measurement, press (A).
- To return to the Timekeeping Mode, press (B).

Note

- If the hour and/or minute hand is located over the digital display when you perform an altitude measurement, the hands will temporarily shift to the 22-second or 38-second position to allow easier reading of measurement values. The hands will unshift to their normal positions after about three seconds.
- When you enter the Altimeter Mode, the function hand indicates the altitude difference if the previous altitude measurement was retained.
 - 🔗 [Checking the Altitude Differential from a Reference Point](#)
- Measurement range: -700 to 10,000 meters (-2,300 to 32,800 feet) (Measurement unit: 1 meter (5 feet)) Note that calibrating altitude readings will cause a change in the measurement range.
- [- -] will appear for the measured value if it is outside the allowable range.

Interpreting Altitude Graph Contents

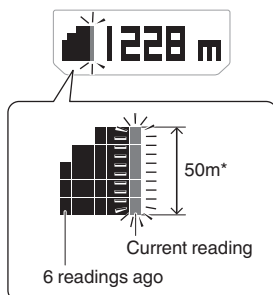

* 1 square (■) is 10 m.

Calibrating Altitude Readings (Offset)

To minimize the difference between locally indicated and measured values, you should update the reference altitude value (offset) before setting off and during treks or any other activities where you take altitude readings.

Also, you can ensure accurate measurements by checking a map local altitude indications or some other source for your current location's altitude, and regularly calibrating watch readings with the latest information while mountain climbing.

Note

- You can find out the altitude at your current location from signs, maps, on the Internet, etc.
- Differences between actual altitude and watch readings can be caused by the factors below.
 - Changes in barometric pressure
 - Changes in temperature caused by variations in barometric pressure and by elevation
- Though altitude readings can be taken without calibration, doing so may produce readings that are very different from indications by altitude markers, etc.

- Enter the Altimeter Mode.
 ◉ [Navigating Between Modes](#)
- Loosen the crown and then pull it out.
 This displays the current altitude and enters the Altitude Offset Mode.

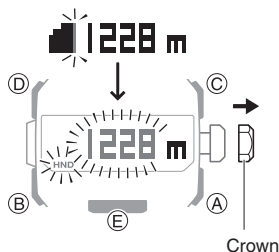

- Rotate the crown to calibrate the displayed value to that of a local altitude (elevation) marker.
 Setting range: -3,000 to 10,000 meters (or -9,840 to 32,800 feet)
 Setting unit: 1 meter (or 5 feet)
 - To return the altitude setting to its initial factory default, press (A) and (C) at the same time.
- Push the crown back in and then lock it.

Note

- If you do not perform any operation for about two minutes after pulling out the crown, crown operations will automatically become disabled. If that happens, push the crown back in and then pull it out again.

Checking the Altitude Differential from a Reference Point

After you set a reference altitude, the second hand of the watch will indicate the difference between your current altitude and the reference altitude. This makes it easy to measure the altitude difference between two points while climbing or trekking.

● Setting the Altitude Differential Measurement Range

- Enter the Altimeter Mode.
 ◉ [Navigating Between Modes](#)
- Loosen the crown and then pull it out.
 This displays the altitude for your current location.

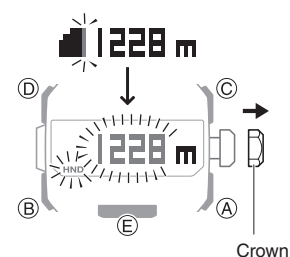

- Press (B) twice.
 This displays the altitude differential measurement range.

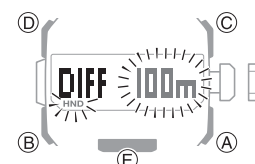

- Rotate the crown to select either [100m] or [1000m].
 [100m]: ±100 meters (±328 feet) in 5-meter (16-foot) units
 [1000m]: ±1000 meters (±3280 feet) in 50-meter (164-foot) units
- Push the crown back in and then lock it.

Note

- If you do not perform any operation for about two minutes after pulling out the crown, crown operations will automatically become disabled. If that happens, push the crown back in and then pull it out again.

Measuring Altitude

1. Use the contour lines on your map to determine the altitude differential between your current location and your destination.

2. Take an altitude reading of your current location.

[Checking the Current Altitude](#)

3. Hold down (D) for at least two seconds to set your current location's altitude as the reference altitude.

This displays [DIFF RESET] → [RESET] and then your current altitude.

- The function hand (Altitude Differential Indicator) will indicate the difference between the reference altitude and the current altitude reading. At this time, the function hand should indicate ± 0 m (± 0 feet).

Altitude differential indicator

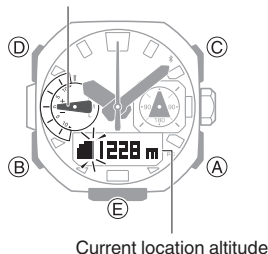

Current location altitude

4. While comparing the difference between the altitude you found on the map and the altitude differential indicated by the watch's function hand, advance towards your destination.

- When the altitude differential you found on the map is the same as that indicated by the function hand, it means you are close to your destination.

Example: Altitude differential of -30 m (-98 feet) (-300 m (-984 feet))

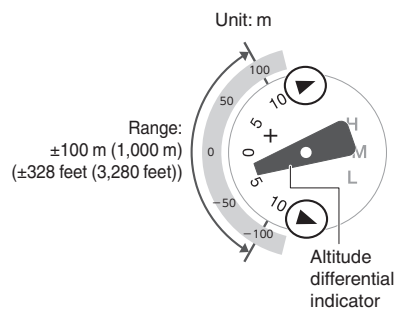

Note

- The function hand points to ▼ (over) if the current altitude differential is greater than the setting value, or ▲ (under) if it is less than the setting value.

If either of these is indicated while using the ± 100 m (328 feet) measurement range, change the range setting to $\pm 1,000$ m (3,280 feet).

- The function hand will point [0] if a reading is outside the allowable altitude measurement range (-700 m to 10,000 m (-2,300 to 32,800 feet)), or if a reading error occurs.

Setting the Auto Measurement Interval

You can select an auto measurement interval of either five seconds or two minutes.

1. Enter the Altimeter Mode.

[Navigating Between Modes](#)

2. Loosen the crown and then pull it out.

This displays the altitude for your current location.

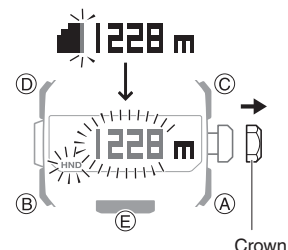

3. Press (B).

This causes the auto measurement interval to appear on the display.

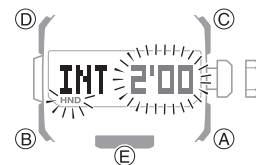

4. Rotate the crown to select [0'05] or [2'00] as the auto measurement interval.

[0'05]: Readings taken every second for the first three minutes, and then every five seconds for about the next one hour.

[2'00]: Readings taken every second for the first three minutes, and then every two minutes for about the next 12 hours.

5. Push the crown back in and then lock it.

Note

- If you do not perform any operation for about two minutes after pulling out the crown, crown operations will automatically become disabled. If that happens, push the crown back in and then pull it out again.
- The watch will automatically return to the Timekeeping Mode if you do not perform any operation in the Altimeter Mode for about one hour while [0'05] is selected as the measurement interval or about 12 hours while [2'00] is selected.

Recording Altitude Readings

Use the procedure below to record altitude measurements manually. Auto measurements are also recorded automatically.

- Use the Altitude Record Recall Mode to view or delete records.

[Viewing Altitude Records](#)

Recording Altitude Data Manually

1. Enter the Altimeter Mode.
[Navigating Between Modes](#)
2. Hold down (A) for at least two seconds until [REC] appears on the display.

This records the current altitude, date, and time.

- There is enough memory to hold up to 30 altitude records.
- Recording altitude data when there are already 30 records in memory automatically deletes the oldest record to make room for the new one.

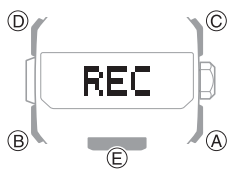

Note

- If Route Log is disabled, the watch will automatically return to normal Altitude Mode operation following recording of altitude data.
- If Route Log is enabled and altitude data is recorded, the watch will connect with the phone and transfer the data to it. When a connection between the watch and phone is established, [REC] changes to [OK], and the second hand moves from [RC] to .

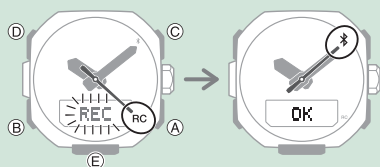

[Recording Waypoints and Their Altitudes \(Route Log\)](#)

- [ERR] will appear on the display if connection fails for some reason.

Auto Altitude Data Recording

The altitude data described below is recorded automatically while the watch is in the Altimeter Mode. One record each is maintained in memory for each of these items.

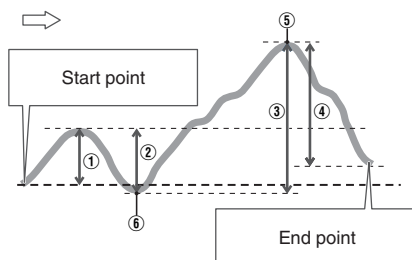

High Altitude (MAX): ⑤

Low Altitude (MIN): ⑥

Cumulative Ascent (ASC): ①+③*

Cumulative Descent (DSC): ②+④*

* Cumulative ascent and cumulative descent values are updated whenever there is a difference of at least ± 15 m (± 49 feet) from one reading to the next.

Note

- Auto recording ends when you exit the Altimeter Mode. Re-entering the Altimeter Mode restarts recording of cumulative values from where it was stopped when you last exited the Altimeter Mode.
- Auto measurement continues if you go from the Altimeter Mode to another mode while Route Log is enabled.
- Every time an auto measurement operation is performed while Route Log is enabled, the watch checks the currently saved values of the following data items and updates them as required: MAX, MIN, ASC, DSC.
[Recording Waypoints and Their Altitudes \(Route Log\)](#)
- [ERR] will appear on the display if connection fails for some reason.

Specifying the Altitude Measurement Unit

You can select either meters (m) or feet (ft) as the Altimeter Mode display unit.

Important!

- When Tokyo (TYO) is set as the Home City, the altitude unit is fixed as meters (m) and cannot be changed.

1. Enter the Timekeeping Mode.
[Navigating Between Modes](#)
2. Loosen the crown and then pull it out. The currently selected Home City will appear on the display.

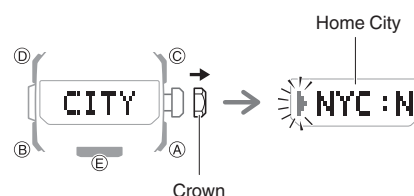

3. Press (B) seven times. This causes [UNIT] to appear, with [m] or [ft] flashing.

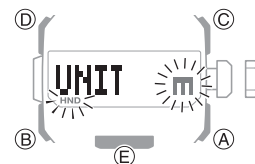

4. Rotate the crown to select an altitude unit.
[m]: Meters
[ft]: Feet



5. Push the crown back in and then lock it.

Note

- If you do not perform any operation for about two minutes after pulling out the crown, crown operations will automatically become disabled. If that happens, push the crown back in and then pull it out again.

Altitude Reading Precautions

Effects of Temperature

When taking altitude readings, take the steps below to keep the watch at as stable a temperature as possible. Changes in temperature can affect altitude readings.

- Take readings with the watch on your wrist.
- Take readings in an area where temperature is stable.

Altitude Readings

- Do not use this watch while skydiving, hang gliding, paragliding, gyrocopter flying, glider flying, or engaged in other activities where altitude changes suddenly.
- Altitude readings produced by this watch are not intended for special-purpose or industrial level use.
- In an aircraft, the watch measures the in-cabin pressurized air pressure, so readings will not match altitudes announced by the crew.

Altitude Readings (Relative Altitude)

This watch uses International Standard Atmosphere (ISA) relative altitude data defined by the International Civil Aviation Organization (ICAO). Barometric pressure generally becomes lower as altitude increases.

Correct measurement may not be possible under the conditions below.

- During unstable atmospheric conditions
- During sudden temperature changes
- After the watch has been subjected to strong impact

Barometric Pressure Measurement

You can use the Barometer Mode to take a reading of the barometric pressure at your current location, and to track reading changes and trends.



Important!

- Check the information at the link below to find out how to ensure correct readings.
 - ◉ [Calibrating Barometric Pressure Readings \(Offset\)](#)
 - ◉ [Barometric Pressure Reading Precautions](#)

Checking the Current Barometric Pressure

1. Enter the Barometer Mode.

◉ [Navigating Between Modes](#)

Entering the Barometer Mode starts measurement, and displays the barometric pressure at your current location and a barometric pressure graph.

- After you enter the Barometer Mode, the watch takes readings about every five seconds for three minutes. After that, a measurement is taken about every two minutes.

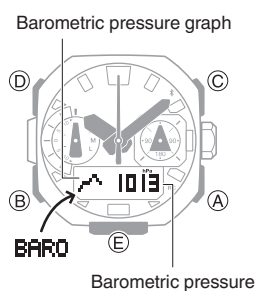

- To retrigger measurement, press (A).
- To return to the Timekeeping Mode, hold down (B) for at least two seconds.

Note

- If the hour and/or minute hand is located over the digital display when you perform a barometric pressure measurement, the hands will temporarily shift to the 22-second or 38-second position to allow easier reading of measurement values. The hands will unshift to their normal positions after about three seconds.
- When you enter the Barometer Mode, the function hand indicates the barometric pressure difference if the previous barometric pressure measurement was retained.
 - ◉ [Checking the Change in Barometric Pressure between Two Readings](#)
- The watch will automatically return to the Timekeeping Mode from the Barometer mode if you do not perform any operation for about one hour.
- The measurement range is 260 hPa to 1,100 hPa (7.65 inHg to 32.45 inHg) (1 hPa (0.05 inHg) units). [- - -] will appear for the measured value if it is outside the allowable range.

Checking Changes in Barometric Pressure Over Time

The watch can be configured to show a graph of pressure readings taken every two hours or every two minutes.

You can display a graph of barometric pressure readings for the past 20 hours or the past 20 minutes. The square (■) at the far right of the graph indicates the latest barometric pressure reading.

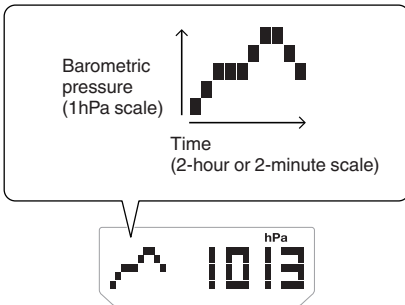

● Changing the Measurement Interval of the Barometric Pressure Graph

You can select a measurement interval of two hours or two minutes for the barometric pressure graph.

1. Enter the Barometer Mode.
[🔗 Navigating Between Modes](#)
2. Loosen the crown and then pull it out.
This displays the current barometric pressure.

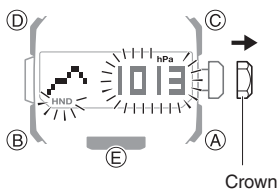

3. Press (B).
This causes the current measurement interval to appear on the display.

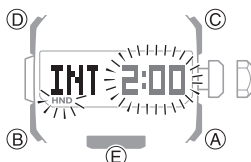

4. Rotate the crown to select [0:02] or [2:00] as the measurement interval.

[0:02]: When the measurement interval of the barometric pressure graph is two minutes, measurements are taken every five seconds.

[2:00]: When the measurement interval of the barometric pressure graph is two hours, measurements are taken every two minutes.

5. Push the crown back in and then lock it.

Note

- If you switch to the two-minute measurement interval graph, the watch will automatically return to the two-hour measurement interval graph after 24 hours.
- Note that the graph will not be displayed immediately after it is switched to a two-minute measurement interval graph.

● Predicting Upcoming Weather

A trend like this:	Means this:
	Rising barometric pressure, which indicates that upcoming weather probably will be fair.
	Falling barometric pressure, which indicates that upcoming weather probably will be bad.

Note

- Large changes in barometric pressure and/or temperature can cause past data readings to be plotted outside of the visible area of the graph. Though plots are not visible, the data is still maintained in watch memory.
- The barometric pressure graph is not displayed while Barometric Pressure Change Indications are displayed.
[🔗 Sudden Barometric Pressure Change Indications](#)

Checking the Change in Barometric Pressure between Two Readings

When you perform the procedure below in the Barometer Mode, the function hand will indicate the difference between the current barometric pressure measurement and the last auto measurement value (taken at two-hour or two-minute intervals).

1. Enter the Barometer Mode.
[🔗 Navigating Between Modes](#)

The function hand indicates the barometric pressure differential (Barometric Pressure Differential Indicator).

Example: Barometric pressure differential of -3 hPa (-0.09 inHg) (two-hour measurement interval)

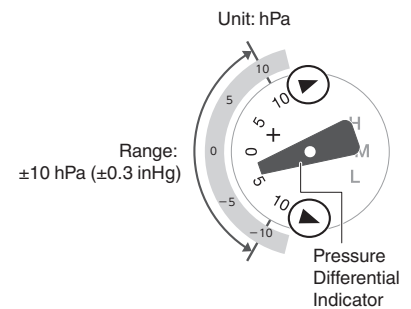

Note

- The function hand points to ▼ (over) if the current barometric pressure differential is greater than +10 hPa (0.3 inHg), or ▲ (under) if it is less than -10 hPa (-0.3 inHg).
- A reading outside the allowable measurement range of 260 hPa to 1,100 hPa (7.65 inHg to 32.45 inHg) or any measurement error will cause the function hand to point to [0].

Sudden Barometric Pressure Change Indications

Whenever the watch detects a significant change in air pressure readings (due to sudden ascent or descent, or to the passage of a low pressure or high pressure area), it will beep to let you know. An arrow will also flash on the display at this time if the watch is in the Barometer Mode, or if it is in the Timekeeping Mode with the barometric pressure graph displayed. The arrow that appears shows the direction of the pressure change. These alerts are called “Barometric Pressure Change Indications”.

This indication:	Means this:
	Sudden drop in pressure
	Sudden rise in pressure
	Sustained rise in pressure, shifting to a fall
	Sustained fall in pressure, shifting to a rise

Important!

- To ensure correct barometric pressure change indication operation, enable it in a location where the altitude is constant (such as a lodge, camp area, or on the ocean).
- A change in altitude causes a change in air pressure. Because of this, correct readings are impossible. Do not take readings while ascending or descending a mountain, etc.

- Enter the Barometer Mode.
[Navigating Between Modes](#)

- Hold down (D) for at least two seconds.
If this turns on barometric pressure change indication, [INFO ON] will stop flashing and then the [BARO] indicator will appear on the display.

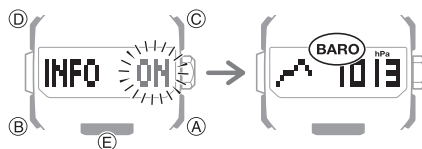

- To disable barometric pressure change indication, hold down (D) again for at least two seconds.

Note

- If Barometric Pressure Change Indications are on, barometric pressure readings are taken every two minutes even while the watch is not in the Barometer Mode.
- The barometric pressure change indication becomes disabled automatically 24 hours after it is enabled.
- You will not be able to turn on barometric pressure change indication if the watch's battery level is low.
- Low battery power will also cause barometric pressure change indication to turn off automatically.

Calibrating Barometric Pressure Readings (Offset)

The watch's pressure sensor is adjusted at the factory and normally does not require calibration. However, you can calibrate the displayed value if you notice major errors in readings.

Important!

- The watch will not be able to produce correct barometric pressure readings if you make a mistake during the calibration procedure. Check to make sure that the value you use for calibration produces correct pressure readings.

- Enter the Barometer Mode.
[Navigating Between Modes](#)
- Loosen the crown and then pull it out. This displays the current barometric pressure and enters the Barometric Pressure Offset Mode.

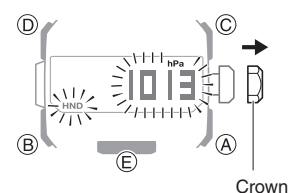

- Rotate the crown to change the value.
Setting range: 260 to 1,100 hPa (or 7.65 inHg to 32.45 inHg)
Setting unit: 1 hPa (or 0.05 inHg)
 - To return the barometric pressure setting to its initial factory default, press (A) and (C) at the same time.
- Push the crown back in and then lock it.

Note

- If you do not perform any operation for about two minutes after pulling out the crown, crown operations will automatically become disabled. If that happens, push the crown back in and then pull it out again.

Specifying the Barometric Pressure Unit

You can specify either hectopascals (hPa) or inches of mercury (inHg) as the display unit for barometric pressure values.

Important!

- When Tokyo (TYO) is the Home City, the barometric pressure unit is fixed as hectopascals (hPa) and cannot be changed.

- Enter the Timekeeping Mode.
[🔗 Navigating Between Modes](#)

- Loosen the crown and then pull it out.
 The currently selected Home City will appear on the display.

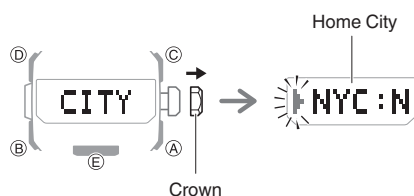

- Press (B) eight times.
 This causes [UNIT] to appear, with [hPa] or [inHg] flashing.

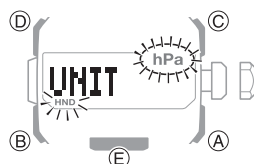

- Rotate the crown to select a barometric pressure unit.
 [hPa]: Hectopascals
 [inHg]: Inches of mercury

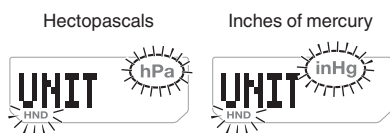

- Push the crown back in and then lock it.

Note

- If you do not perform any operation for about two minutes after pulling out the crown, crown operations will automatically become disabled. If that happens, push the crown back in and then pull it out again.

Barometric Pressure Reading Precautions

- The barometric pressure graph produced by this watch can be used to obtain an idea of upcoming weather conditions. However, this watch should not be used in place of precision instruments required for official weather prediction and reporting.
- Pressure sensor readings can be affected by sudden changes in temperature. Because of this, there may be some error in the readings produced by the watch.

Temperature Measurement

The watch can be used to take current air temperature readings.



Important!

- Check the information at the link below to find out how to ensure correct readings.
[🔗 Temperature Reading Precautions](#)

Checking the Current Temperature

- Enter the Thermometer Mode.
[🔍 Navigating Between Modes](#)
 Entering the Thermometer Mode will start temperature measurement and display the result.
 - After you enter the Thermometer Mode, the watch takes readings about every five seconds for three minutes. After that, a measurement is taken about every two minutes.
 - To retrigger measurement, press (A).

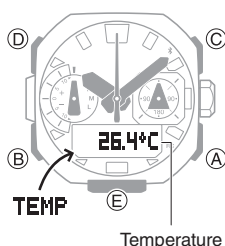

Note

- If the hour and/or minute hand is located over the digital display when you perform a temperature measurement, the hands will temporarily shift to the 22-second or 38-second position to allow easier reading of measurement values. The hands will unshift to their normal positions after about three seconds.
- The watch will automatically return to the Timekeeping Mode if you do not perform any operation in the Thermometer Mode for about one hour.
- The measuring range is $-10.0\text{ }^{\circ}\text{C}$ to $60.0\text{ }^{\circ}\text{C}$ ($14.0\text{ }^{\circ}\text{F}$ to $140.0\text{ }^{\circ}\text{F}$) ($0.1\text{ }^{\circ}\text{C}$ ($0.2\text{ }^{\circ}\text{F}$) units). [- - -] will appear for the measured value if it is outside the allowable range.
- To return to the Timekeeping Mode, hold down (B) for at least two seconds.

Calibrating Temperature Readings (Offset)

The watch's temperature sensor is adjusted at the factory and normally does not require calibration. However, you can calibrate the displayed value if you notice major errors in readings.

Important!

- Check to make sure that the value you use for calibration produces correct temperature readings.
- Before calibrating the temperature reading, remove the watch from your wrist and leave it in the area where you plan to measure temperature for about 20 or 30 minutes to allow the case temperature to become the same as the air temperature.

- Enter the Thermometer Mode.
[🔍 Navigating Between Modes](#)
- Loosen the crown and then pull it out.
 This displays the current temperature.

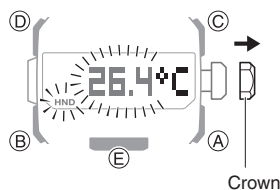

- Rotate the crown to calibrate the temperature value.
 Calibration unit: $0.1\text{ }^{\circ}\text{C}$ ($0.2\text{ }^{\circ}\text{F}$)
 - To return the barometric pressure setting to its initial factory default, press (A) and (C) at the same time.
- Push the crown back in and then lock it.

Note

- If you do not perform any operation for about two minutes after pulling out the crown, crown operations will automatically become disabled. If that happens, push the crown back in and then pull it out again.

Specifying the Temperature Measurement Unit

You can select either Celsius ($^{\circ}\text{C}$) or Fahrenheit ($^{\circ}\text{F}$) as the temperature display unit.

Important!

- When Tokyo (TYO) is the Home City, the temperature unit is fixed as Celsius ($^{\circ}\text{C}$) and cannot be changed.

- Enter the Timekeeping Mode.
[🔍 Navigating Between Modes](#)
- Loosen the crown and then pull it out.
 The currently selected Home City will appear on the display.

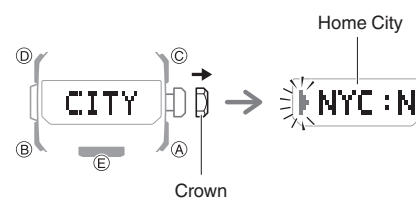

- Press (B) nine times.
 This causes [UNIT] to appear, with [$^{\circ}\text{C}$] or [$^{\circ}\text{F}$] flashing.

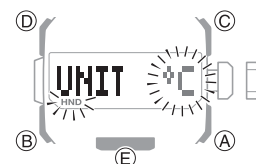

- Rotate the crown to select a temperature unit.
 $^{\circ}\text{C}$: Celsius
 $^{\circ}\text{F}$: Fahrenheit



- Push the crown back in and then lock it.

Note

- If you do not perform any operation for about two minutes after pulling out the crown, crown operations will automatically become disabled. If that happens, push the crown back in and then pull it out again.

Temperature Reading Precautions

Body temperature, direct sunlight, and humidity all have an effect on temperature readings. To help ensure more accurate temperature readings, remove the watch from your wrist, wipe it dry of any moisture, and place it in a well-ventilated location not exposed to direct sunlight. You should be able to take temperature readings after about 20 to 30 minutes.

Viewing Altitude Records

You can use the Altitude Record Recall Mode to view manually recorded and auto recorded data.

[Recording Altitude Readings](#)

Viewing Recorded Data

1. Enter the Altitude Record Recall Mode.

[Navigating Between Modes](#)

This displays a record of data recorded in the Altimeter Mode.

2. Use (A) and (C) to display the data you want to view.

- Holding down (A) or (C) scrolls at high speed.

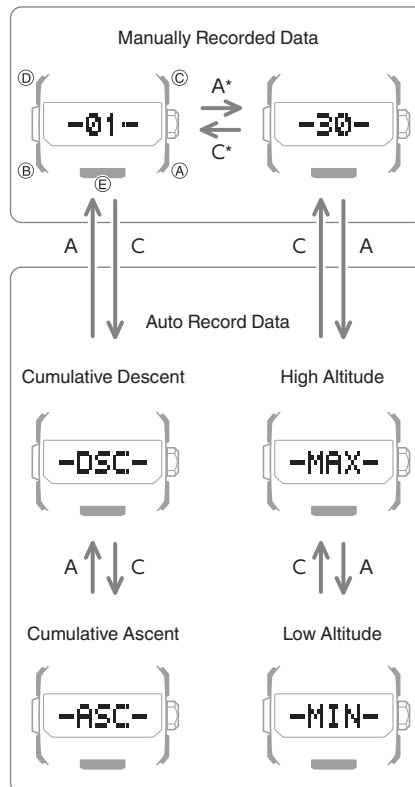

* Each press of a button scrolls to the top screen of the next manually recorded data record, numbered from 1 ([-01-]) to a maximum of 30 ([-30-]).

Note

- If there is no data left in memory due to a data delete operation, error, or some other reason, [- - -] or [0] will appear on the display.
- If the cumulative ascent (ASC) or cumulative descent (DSC) value exceeds 99,999 m (327,995 feet), it will revert to 0 and continue from there.
- Pressing (D) returns to the top screen (record number, DSC, ASC, MAX, or MIN) of the data that you are viewing.
- If you do not perform any operation for about three minutes while in the Altitude Record Recall Mode, the watch automatically returns to the Timekeeping Mode.

Manually Recorded Data

After displaying the top screen of a manually recorded data record (01 through 30), the record's data screens appear in sequence as shown below.

Example: Manually recorded Record 01

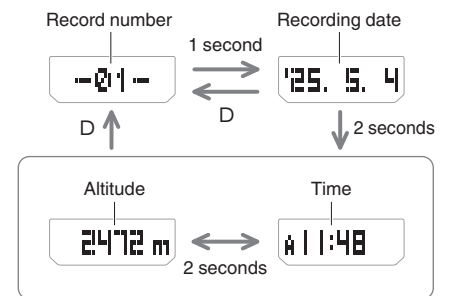

● Auto Recorded Data

After displaying an auto recorded data record, you can navigate between the record's data screens as shown below.

High altitude and low altitude

Example: High altitude



Cumulative ascent and cumulative descent

Example: Cumulative ascent

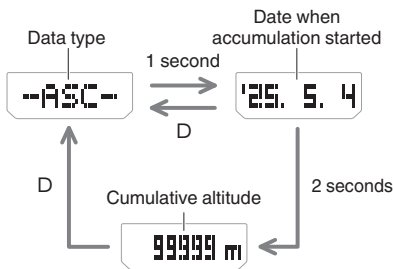

Deleting Data

● Deleting a Particular Record

1. Enter the Altitude Record Recall Mode.
[Navigating Between Modes](#)
2. Use the (A) and (C) buttons to scroll through the top screens of the records and display the one you want to delete.
3. Hold down (D) for at least two seconds. Release the button when [CLEAR] appears on the display.
 This deletes the record you selected.

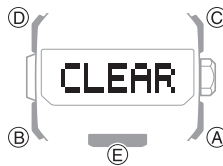

- Note that holding down (D) for more than five seconds will delete all data.

● Deleting All Records

Hold down (D) for at least five seconds until [CLEAR ALL] appears on the display. This indicates that all data was deleted.



Sunrise and Sunset Times

You can use the watch to check sunrise and sunset times for your Home City.



Looking Up Today's Sunrise and Sunset Times

1. Enter the Sunrise/Sunset Mode.
[Navigating Between Modes](#)
 This will cause the display to alternate at two-second intervals between the sunrise and sunset times for the current date in your Home City.

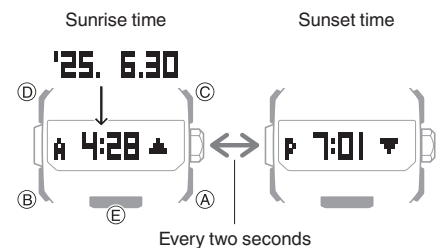

Looking Up Sunrise and Sunset Times by Specifying a Day

- Enter the Sunrise/Sunset Mode.
[Navigating Between Modes](#)
- Use (A) and (C) to select the day you want.
 This displays the sunrise and sunset times for the day you specified.

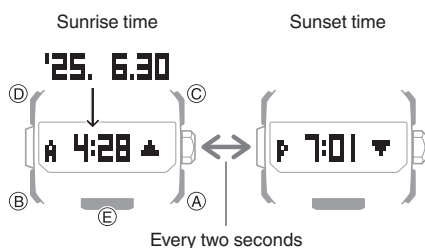

Note

- Sunrise and sunset times are calculated internally by the watch. Calculation results may contain errors, with greater errors occurring at higher latitudes.
- [--:--] is displayed when calculation results cannot be output for some reason.
- If you do not perform any operation for about three minutes while in the Sunrise/Sunset Mode, the watch automatically returns to the Timekeeping Mode.

Stopwatch

The stopwatch can be used to perform 1/100 second elapsed time measurement up to 23 hours, 59 minutes, 59.99 seconds.

It can also measure split times.



Measuring Elapsed Time

- Enter the Stopwatch Mode.
[Navigating Between Modes](#)
- Use the operations below to measure elapsed time.

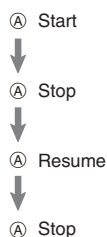

Hours, minutes, seconds, 1/100 seconds

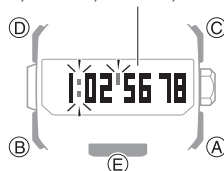

- Press (C) to reset the measurement time to all zeros.

Measuring a Split Time

- Enter the Stopwatch Mode.
[Navigating Between Modes](#)
- Use the operations below to measure elapsed time.

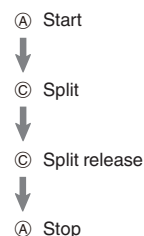

Hours, minutes, seconds, 1/100 seconds

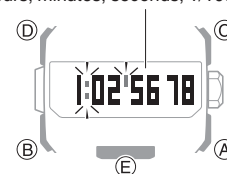

- Press (C) to reset the measurement time to all zeros.

Timing the First and Second Place Finishers

- Enter the Stopwatch Mode.
[Navigating Between Modes](#)
- Use the operations below to measure elapsed time.



* Displays the time of the first finisher.

Hours, minutes, seconds, 1/100 seconds

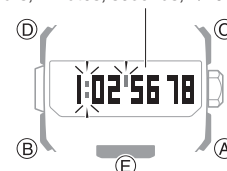

- Press (C) to display the time of the second place finisher.
- Press (C) to reset the measurement time to all zeros.

Timer

The timer counts down from a start time specified by you. A beeper sounds when the end of the countdown is reached.

- The beeper will not sound if battery power is low.



Using the CASIO WATCHES Phone App to Configure Timer Settings

If the watch is paired with a phone, you can also use the CASIO WATCHES phone app to set the timer start time.

[Configuring Watch Settings](#)

Setting a Start Time

The start time can be set in 1-minute units up to 60 minutes.

1. Enter the Timer Mode.
[Navigating Between Modes](#)
2. Loosen the crown and then pull it out.
This causes the minutes digits to flash.

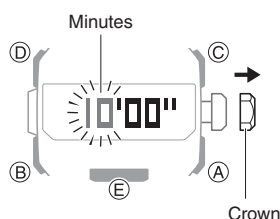

3. Rotate the crown to change the timer start time minutes.
4. Push the crown back in and then lock it.

Note

- If you do not perform any operation for about two minutes after pulling out the crown, crown operations will automatically become disabled. If that happens, push the crown back in and then pull it out again.

Using the Timer

1. Enter the Timer Mode.
[Navigating Between Modes](#)
2. Use the operations below to perform a timer operation.

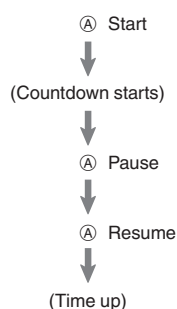

- A beeper sounds for 10 seconds to let you know when the end of a countdown is reached.
 - You can reset a paused countdown to its start time, by pressing (C).
3. Press any button to stop the tone.

Hand Alignment Adjustment

Strong magnetism or impact can cause the time indicated by the analog hands to become different from the time on the display. If this happens, adjust hand alignment.

Using the CASIO WATCHES Phone App to Adjust Hand Alignment

If the watch is paired with a phone, you can also use CASIO WATCHES to adjust hand alignment.

[Adjusting Hand Alignment](#)

Adjusting Hand Alignment

1. Enter the Timekeeping Mode.
[Navigating Between Modes](#)
2. Loosen the crown and then pull it out.
The currently selected Home City will appear on the display.
 - This causes the second hand to move to 12 o'clock.

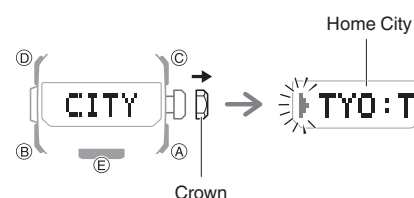

- Hold down (A) for at least five seconds. Release the button when [HAND SET] appears on the display and the second hand completes one full rotation.

[HAND ADJ] flashes, and hour, minute, and second hand auto calibration starts.

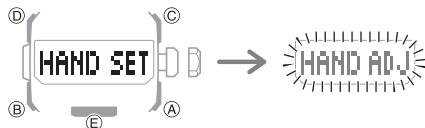

- After auto alignment is complete, the hands should be in the positions shown below.

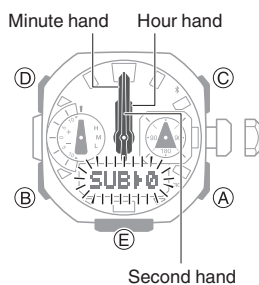

- Press (B).

This enables adjustment of the bearing hand alignment.

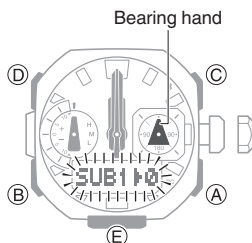

- If the bearing hand is not aligned with 12 o'clock, rotate the crown to align it correctly.

- Press (B).

This enables adjustment of the function hand alignment.

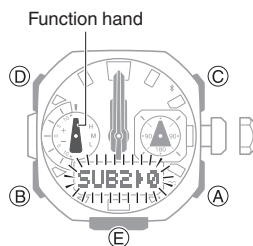

- If the function hand is not aligned with 12 o'clock, rotate the crown to align it correctly.

- Push the crown back in and then lock it.

This returns the hands to normal timekeeping.

Note

- If you do not perform any operation for about two minutes after pulling out the crown, crown operations will automatically become disabled. If that happens, push the crown back in and then pull it out again.

Important!

- After hand position adjustment is complete, check to make sure that the proper time is being indicated by the hands in the Timekeeping Mode and on the display. If the hands are misaligned, perform steps 2 through 8 again.

Other Settings

This section explains other watch settings you can configure.

Enabling the Button Operation Tone

Use the procedure below to enable or disable the tone that sounds when you press a button.

- Enter the Timekeeping Mode.
 - [Navigating Between Modes](#)

- Loosen the crown and then pull it out.

The currently selected Home City will appear on the display.

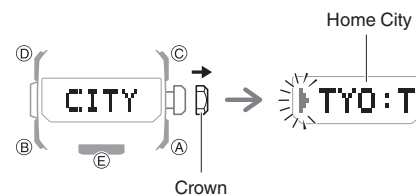

- Press (B) twice.

This causes [KEY ↵] or [MUTE] to flash on the display.

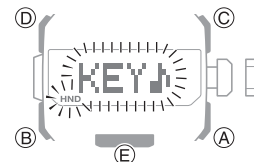

- Rotate the crown to select either [KEY ↵] or [MUTE].

[KEY ↵]: Operation tone enabled.

[MUTE]: Operation tone muted.

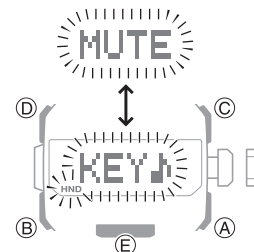

- Push the crown back in and then lock it.

Note

- If you do not perform any operation for about two minutes after pulling out the crown, crown operations will automatically become disabled. If that happens, push the crown back in and then pull it out again.
- Note that alarm and timer tones still sound even while the operation tone is muted.

Configuring Power Saving Function Settings

1. Enter the Timekeeping Mode.
[🔍 Navigating Between Modes](#)
2. Loosen the crown and then pull it out.
 The currently selected Home City will appear on the display.

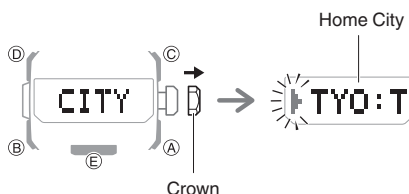

3. Press (B) six times.
 This displays [P.SAVE].



4. Rotate the crown to turn the setting on or off.
 [ON]: Power Saving enabled.
 [OFF]: Power Saving disabled.
5. Push the crown back in and then lock it.

Note

- If you do not perform any operation for about two minutes after pulling out the crown, crown operations will automatically become disabled. If that happens, push the crown back in and then pull it out again.
- For details about Power Saving, refer to the information below.
[🔍 Power Saving Function](#)

Resetting Watch Settings

This section explains how to return the watch settings below to their initial factory defaults.

- Watch Settings
- Compass
- Altimeter
- Barometer
- Thermometer
- Altitude recording
- Stopwatch
- Timer
- Alarm

1. Enter the Timekeeping Mode.
[🔍 Navigating Between Modes](#)
2. Loosen the crown and then pull it out.
 The currently selected Home City will appear on the display.

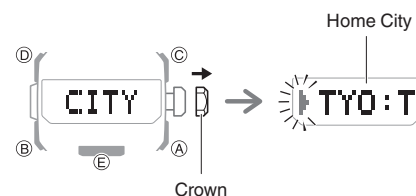

3. Hold down (D) for at least seven seconds.
 Release the button when the displayed message changes from [CLEAR ALL] to [CLEAR].

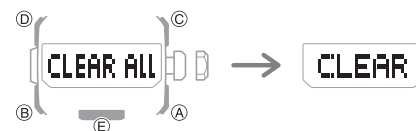

4. Push the crown back in and then lock it.

Important!

- Reset cannot be performed while Route Log is enabled.
- [Recording Waypoints and Their Altitudes \(Route Log\)](#)

Note

- If you do not perform any operation for about two minutes after pulling out the crown, crown operations will automatically become disabled. If that happens, push the crown back in and then pull it out again.
- Resetting the watch also deletes information for pairing the watch with a phone, and unpair them.

Specifications

Accuracy :

±15 seconds per month when time correction by time calibration signal reception or by communication with a phone is not possible.

Basic Functions :

Analog
Hour, minute (moves every 10 seconds), second

Digital
Hour, minute, second, month, day, day of the week
Barometric pressure graph
a.m. (A)/p.m. (P)/24-hour timekeeping
Full Auto Calendar (2000 to 2099)

Signal Receive Functions :

Auto receive, manual receive
Last receive date and time display
Auto summer time switching
Auto transmitter selection (for JJY, MSF/DCF77)
Receivable call signs:
JJY (40 kHz/60 kHz), WWVB (60 kHz), MSF (60 kHz), DCF77 (77.5 kHz), BPC (68.5 kHz)
Auto Receive enable/disable

Digital Compass :

Measurement range: 0° to 359°
Measurement Units: LCD: 1°, Analog: 6°
16-direction display
Continuous Bearing Measurement (1 minute)
North Indication Hand
Auto level correction
Bearing calibration (3-point calibration, figure 8 calibration, magnetic declination calibration)
Bearing memory

Altimeter (relative altitude) :

Measuring range: -700 to 10,000 m (or -2,300 to 32,800 ft.)
Display range: -3,000 to 10,000 m (or -9,840 to 32,800 ft.)
(Altitude calibration can be used to display any 10,700 m within the range above.)
Measuring unit: 1 m (or 5 ft.)
Auto measurement interval (2 minutes, 5 seconds)
Altitude calibration
Altitude graph
Altitude differential measurement (-100 to +100 m/-1,000 to +1,000 m (or -325 to +325 ft./-3,280 to +3,280 ft.))

Altitude differential indicator

Altitude Memory

Manually Recorded Data

One-press recording of altitude, date (year, month, day), and time. Up to 30 records.

Auto Record Data

One record of high altitude, low altitude, cumulative ascent, cumulative descent

Barometer :

Measurement range: 260 to 1,100 hPa (or 7.65 to 32.45 inHg)
Display range: 260 to 1,100 hPa (or 7.65 to 32.45 inHg)
Measurement unit: 1 hPa (or 0.05 inHg)
Calibration
Barometric pressure graph
Graph interval setting (2 minutes/2 hours)
Barometric pressure differential indicator
Barometric pressure change indications

Temperature :

Measuring range: -10.0 to 60.0 °C (or 14.0 to 140.0 °F)
Display range: -10.0 to 60.0 °C (or 14.0 to 140.0 °F)
Measuring unit: 0.1 °C (or 0.2 °F)
Calibration

Sensor Accuracy :

Direction sensor
Measurement accuracy: Within ±10°
(Guaranteed accuracy temperature range: 10 °C to 40 °C (50 °F to 104 °F))
Bearing hand indication: Within ±2 gradations

Pressure sensor
Measurement accuracy: Within ±3 hPa (0.1 inHg)
(Altimeter measurement accuracy: Within ±75 m (246 ft.))

- Guaranteed accuracy temperature range: -10 °C to 40 °C (14 °F to 104 °F)
- Strong impact or prolonged exposure to temperature extremes may negatively affect accuracy.

Temperature Sensor
Measurement accuracy: Within ±2 °C (3.6 °F)
(Guaranteed accuracy temperature range: -10 °C to 60 °C (14 °F to 140 °F))

Sunrise/Sunset Functions :

Sunrise/Sunset times display ([-:-:-] displayed when calculation results cannot be output for some reason.)
Day select

Stopwatch :

Measuring unit: 1/100 second
Measuring range:
23 hours, 59 minutes, 59.99 seconds (24 hours)
Measurement Functions:
Elapsed time, cumulative time, split times, 1st and 2nd place finisher times

Timer :

Setting unit: 1 minute
Measuring range: 60 minutes
Countdown unit: 1 second
Time up alert duration: 10 seconds

Alarm :

Daily alarm
Number of alarms: 5
Setting units: Hours, minutes
Alarm beeper duration: 20 seconds
Hourly time signal: Beep every hour on the hour

World Time :

Current time in 55 cities (38 time zones) and UTC (Coordinated Universal Time)
Summer time
City swapping
One-touch UTC display

Mobile Link :

Auto Time Correction
Time setting adjusted automatically at preset time.
One-touch Time Correction
Manual connection and time adjustment
Phone finder
Watch operation sounds the alert sound of the phone.
World Time
A selection of more than 300 World Time cities
Auto Daylight Saving Time (summer time) switching
Automatic switching between standard time and summer time.
Route Log
Recording of waypoints and their altitudes
Location Indicator
Shows the bearing and distance to a location registered on the watch.

Auto altitude calibration

Automatic altitude calibration at a preset time

Timer Settings

Alarm Settings

Mode sort sequence and number of modes setting

Altimeter settings

Hand alignment correction

TIME&PLACE

Communication Specifications

Bluetooth®

Frequency band: 2400 MHz to 2480 MHz
Maximum transmission power: 0 dBm (1 mW)

Communication range: Up to 2 meters (depends on environment)

Other :

High-brightness double LED light: Face LED light and LCD LED backlight (Full Auto Light, afterglow, selectable illumination duration (1.5 or 3 seconds)); auto hand alignment correction; power saving; low battery alert; operation tone enable/disable; hand shift

Power Supply :

Solar panel and one rechargeable battery (Type: CTL1616)

Battery nominal voltage: 2.3V

Battery operating time: Approximately 6 months

Conditions:

Auto time correction using a smartphone: 4 times/day

Alarm: Once (20 seconds)/day

Illumination: Once (1.5 seconds)/day

Display and second hand movement: 18 hours/day

Direction readings: 60 seconds continuous, 20 times/month

Climbs: 1/month

- Altitude Measurement

Every second for 3 minutes + every 5 seconds for 57 minutes

- Barometric Pressure Change Indications

Every second for 3 minutes + every 2 minutes for 23 hours and 57 minutes

- Route Log Measurement

Every 2 minutes for 12 hours

- Location Indicator Measurement

10 times for 3 minutes each

Barometric pressure graph measurements: 12 times/day

Specifications are subject to change without notice.

Other Information

This section provides non-operational information you also need to know. Refer to this information as required.

City Table

City		Offset
UTC	Coordinated Universal Time	
LIS: LISBON *	Lisbon	0
LON: LONDON *	London	
MAD: MADRID *	Madrid	
PAR: PARIS *	Paris	
ROM: ROME *	Rome	+1
BER: BERLIN *	Berlin	
STO: STOCKHOLM *	Stockholm	
ATH: ATHENS *	Athens	
CAI: CAIRO	Cairo	+2
JRS: JERUSALEM	Jerusalem	
MOW: MOSCOW	Moscow	+3
JED: JEDDAH	Jeddah	
THR: TEHRAN	Tehran	+3.5
DXB: DUBAI	Dubai	+4
KBL: KABUL	Kabul	+4.5
KHI: KARACHI	Karachi	+5
DEL: DELHI	Delhi	+5.5
KTM: KATHMANDU	Kathmandu	+5.75
DAC: DHAKA	Dhaka	+6
RGN: YANGON	Yangon	+6.5
BKK: BANGKOK	Bangkok	+7

City	Offset
SIN: SINGAPORE	Singapore
HKG: HONG KONG *	Hong Kong
BJS: BEIJING *	Beijing
TPE: TAIPEI *	Taipei
EUC: EUCLA	Eucla
SEL: SEOUL *	Seoul
TYO: TOKYO *	Tokyo
ADL: ADELAIDE	Adelaide
GUM: GUAM	Guam
SYD: SYDNEY	Sydney
LDH: LORD HOWE ISLAND	Lord Howe Island
NOU: NOUMEA	Noumea
WLG: WELLINGTON	Wellington
CHT: CHATHAM ISLAND	Chatham Islands
TBU: NUKUALOFA	Nuku'alofa
CXI: KIRITIMATI	Kiritimati
BAR: BAKER ISLAND	Baker Island
PPG: PAGO PAGO	Pago Pago
HNL: HONOLULU	Honolulu
NHV: MARQUESAS ISLANDS	Marquesas Islands
ANC: ANCHORAGE	Anchorage
YVR: VANCOUVER *	Vancouver
LAX: LOS ANGELES *	Los Angeles
YEA: EDMONTON *	Edmonton
DEN: DENVER *	Denver

City	Offset
MEX: MEXICO CITY *	Mexico City
CHI: CHICAGO *	Chicago
NYC: NEW YORK *	New York
YHZ: HALIFAX *	Halifax
YYT: ST. JOHN'S	St. John's
BUE: BUENOS AIRES	Buenos Aires
RIO: RIO DE JANEIRO	Rio de Janeiro
FEN: F. DE NORONHA	Fernando de Noronha
RAI: PRAIA	Praia

* Cities where time calibration signal reception is possible.

- The information in the above table is current as of July 2024.
- Time zones may change and UTC differentials may become different from those shown in the table above.

Summer Time Table

When [AUTO] is selected for a city that observes summer time, switching between standard time and summer time will be performed automatically at the timing shown in the table below.

Note

- Summer time start and end dates for your current location may be different from those shown below. If this happens, you can have new summer time information for your Home City and World Time City sent to the watch by connecting the watch with a phone. If the watch is not connected with a phone, you can change the summer time setting manually.

City Name	Summer Time Start	Summer Time End
Lisbon	01:00, last Sunday in March	02:00, last Sunday in October
London	01:00, last Sunday in March	02:00, last Sunday in October
Madrid	02:00, last Sunday in March	03:00, last Sunday in October
Paris	02:00, last Sunday in March	03:00, last Sunday in October
Rome	02:00, last Sunday in March	03:00, last Sunday in October
Berlin	02:00, last Sunday in March	03:00, last Sunday in October
Stockholm	02:00, last Sunday in March	03:00, last Sunday in October
Athens	03:00, last Sunday in March	04:00, last Sunday in October
Jerusalem	02:00, the Friday before the last Sunday in March	02:00, last Sunday in October
Sydney, Adelaide	02:00, first Sunday in October	03:00, first Sunday in April
Lord Howe Island	02:00, first Sunday in October	02:00, first Sunday in April
Wellington	02:00, last Sunday in September	03:00, first Sunday in April
Chatham Islands	02:45, last Sunday in September	03:45, first Sunday in April

City Name	Summer Time Start	Summer Time End
Anchorage	02:00, second Sunday in March	02:00, first Sunday in November
Vancouver	02:00, second Sunday in March	02:00, first Sunday in November
Los Angeles	02:00, second Sunday in March	02:00, first Sunday in November
Edmonton	02:00, second Sunday in March	02:00, first Sunday in November
Denver	02:00, second Sunday in March	02:00, first Sunday in November
Chicago	02:00, second Sunday in March	02:00, first Sunday in November
New York	02:00, second Sunday in March	02:00, first Sunday in November
Halifax	02:00, second Sunday in March	02:00, first Sunday in November
St. John's	02:00, second Sunday in March	02:00, first Sunday in November

- The information in the above table is current as of July 2024.

Supported Phone Models

For information about phones that can connect with the watch, visit the CASIO website.

https://world.casio.com/os_mobile/wat/

Copyrights and Registered Trademarks

- The Bluetooth® word mark and logos are registered trademarks owned by the Bluetooth SIG, Inc. and any use of such marks by CASIO Computer Co., Ltd. is under license.
- iPhone and App Store are trademarks of Apple Inc. in the United States and other countries.
- IOS is a trademark or registered trademark of Cisco Systems, Inc.
- Android and Google Play™ are trademarks or registered trademarks of Google LLC.
- Other company names and product names used herein are trademarks or registered trademarks of their respective companies.

Troubleshooting

Signal Reception (Time Calibration Signal)

Q1 The watch cannot perform a receive operation.

Is the watch's battery charged?

Signal reception is not possible while battery power is low. Keep the watch exposed to light until it recharges sufficiently.

↪ [Charging](#)

Is the watch in the Timekeeping Mode?

Time signal receive is performed only while the watch is in the Timekeeping Mode. Return to the Timekeeping Mode.

↪ [Navigating Between Modes](#)

Is your Home City setting correct for your location?

The watch will not indicate the correct time if the Home City setting is wrong. Change your Home City setting so it correctly reflects your location.

↪ [Setting a Home City](#)

After checking the above, the watch still cannot perform a receive operation.

Time calibration signal reception is not possible under the conditions described below.

- When watch is at Level 2 power saving
- When the crown is pulled out
- Timer countdown operation in progress

If successful reception is not possible for some reason, you can adjust the time and day settings manually.

Q2 The signal receive operation always fails.

Is the watch in a location that is appropriate for signal reception?

Check your surroundings and move the watch to a location where signal reception is better.

↪ [Appropriate Signal Reception Location](#)

Did you avoid touching the watch while the receive operation was in progress?

Minimize movement of the watch and do not perform any watch operation while a receive operation is in progress.

Is there an alarm configured to sound during the same period that the signal receive operation is performed?

Receive stops if an alarm operation starts while it is being performed. Disable the alarm.

↪ [Turning Off an Alarm or the Hourly Time Signal](#)

Is the signal transmitter in your area transmitting a signal?

The transmitter of the time calibration may not be transmitting a signal. Try again later.

Q3 Signal reception should have been successful, but the watch's time and/or day is wrong.

Is the indicated time off by one hour or by 30 minutes?

The watch may be using the wrong time offset. Specify the area you want to use as your Home City.

↪ [Setting a Home City](#)

Is the indicated hour and/or minute wrong?

The hour hand and/or minute hand may be out of alignment. Perform the procedure under "Hand Alignment Adjustment" to auto adjust hour and minute hand alignment.

↪ [Hand Alignment Adjustment](#)

After checking the above, the time and/or day settings is still wrong.

Adjust time and day settings manually.

↪ [Using Watch Operations to Adjust the Time Setting](#)

I can't pair the watch with a phone.

Q1 I've never been able to establish a (pairing) connection between the watch and phone.

Are you using a supported phone model?

Check if the phone model and its operating system are supported by the watch.

For information about supported phone models, visit the CASIO Website.

↪ https://world.casio.com/os_mobile/wat/

Did you install the CASIO WATCHES phone app on your phone?

The CASIO WATCHES phone app needs to be installed on your phone in order to connect with the watch.

↪ [Install the app on your phone.](#)

Are your phone's Bluetooth settings configured correctly?

Configure the phone's Bluetooth settings. For details about setting procedures, see your phone documentation.

iPhone Users

- "Settings" → "Bluetooth" → On
- "Settings" → "Privacy" → "Bluetooth" → "CASIO WATCHES" → On

Android Users

- Enable Bluetooth.

Other than the above.

Some phones need to have BT Smart disabled to use the CASIO WATCHES phone app. For details about setting procedures, see your phone documentation.

On the Home Screen, tap: "Menu" → "Settings" → "Bluetooth" → "Menu" → "BT Smart settings" → "Disable".

I can't reconnect the watch and phone.

Q1 The watch will not re-connect with the phone after they are disconnected.

Is the CASIO WATCHES phone app running?

The watch cannot re-connect with your phone unless CASIO WATCHES is running on the phone. On your phone's Home Screen, tap the "CASIO WATCHES" icon. Next, on the watch, hold down (B) for at least five seconds.

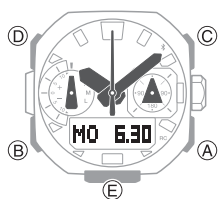

Have you tried turning your phone off and then back on again?

Turn your phone off and then back on, and then tap the "CASIO WATCHES" icon. Next, on the watch, hold down (B) for at least five seconds.

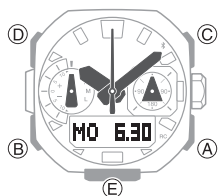

Is a timer countdown operation in progress?

Connection with a phone is not possible while there is 30 seconds or less remaining on a countdown timer operation. Stop the countdown operation before connecting with the phone.

Q2 I can't connect while my phone is in the Airplane Mode.

Connection with the watch is not possible while your phone is in the Airplane Mode. After disabling the phone's Airplane Mode, go to the phone's Home Screen and tap the "CASIO WATCHES" icon. Next, on the watch, hold down (B) for at least five seconds.

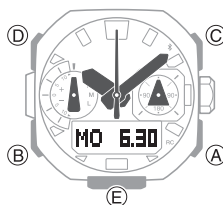

Q3 I changed the phone's Bluetooth from enabled to disabled, and now I can't connect anymore.

On your phone, re-enable Bluetooth, and then go to the Home Screen and tap the "CASIO WATCHES" icon. Next, on the watch, hold down (B) for at least five seconds.

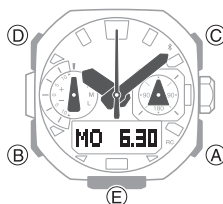

Q4 I can't connect after turning off the phone.

Turn your phone off and then back on, and then tap the "CASIO WATCHES" icon. Next, on the watch, hold down (B) for at least five seconds.

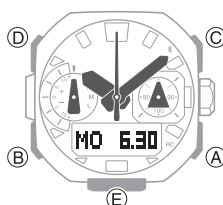

Phone-Watch Connection

Q1 I can't establish a connection between the phone and watch.

Have you tried turning your phone off and then back on again?

Turn your phone off and then back on, and then tap the "CASIO WATCHES" icon. Next, on the watch, hold down (B) for at least five seconds.

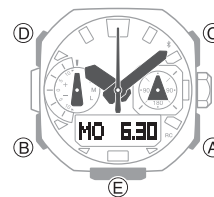

Has the watch been re-paired with the phone?

After deleting the pairing information from the CASIO WATCHES phone app and your phone, re-pair the watch and phone.

- 🔗 [Deleting Pairing Information from the CASIO WATCHES phone app](#)
- 🔗 ③ [Pair the watch with a phone.](#)

If you are unable to establish a connection...

After deleting pairing information from the watch, re-pair it with your phone.

- 🔗 [Deleting Pairing Information from the Watch](#)
- 🔗 ③ [Pair the watch with a phone.](#)

Changing to a Different Phone Model

Q1 Connecting the current watch to another phone.

Delete the pairing information from your watch and then pair it with the phone you want to connect with.

🔗 [If you purchase another phone](#)

Auto Time Correction by Bluetooth Connection (Time Correction)

Q1 When does the watch correct its time?

The watch will connect with the phone and perform auto time correction at around 12:30 a.m., 6:30 a.m., 12:30 p.m. and 6:30 p.m. The connection is automatically terminated after auto time correction is complete.

Q2 Auto time correction is performed, but the time setting is not correct.

Is auto time correction not being performed according to its normal schedule?

Note that auto time correction is not performed for 24 hours after swapping of the Home Time and World Time, or after the time setting is corrected manually on the watch. Auto time correction will resume 24 hours after either of the above operations is performed.

Is auto time correction enabled?

Auto time correction is not performed at the scheduled times if it is not enabled. Enable auto time correction.

[Using the Watch in a Medical Facility or Aircraft](#)

Q3 Time is not displayed correctly.

If your phone is unable to receive a signal because you are outside its service range or for some other reason, the watch may not be able to display the correct time. If this happens, connect the phone to its network and then correct the time setting.

Altitude Measurement

Q1 Readings produce different results at the same location.
Watch readings are different from altitude information available from other sources.
Correct altitude readings are not possible.

Relative altitude is calculated based on changes in barometric pressure measured by the watch's pressure sensor. This means that barometric pressure changes can cause readings taken at the same location to be different. Also note that the value displayed by the watch may be different from the actual elevation and/or sea level elevation indicated for the area where you are located. When using the watch's altimeter while mountain climbing, it is recommended that you regularly calibrate its readings in accordance with local altitude (elevation) indications.

[Calibrating Altitude Readings \(Offset\)](#)

Q2 Following a relative altitude reading, the watch's function hand points to [0].

The function hand moves to [0] if a reading is outside the allowable altitude measurement range (-700 m to 10,000 m (-2,300 feet to 32,800 feet)). If [ERR] is displayed, there may be a problem with the sensor.

[Checking the Altitude Differential from a Reference Point](#)

Q3 [ERR] appears during measurement.

There may be a problem with the sensor. Try taking another measurement.

If [ERR] keeps appearing after multiple measurement attempts, contact a CASIO service center or your original retailer.

Digital Compass

Q1 The entire display is flashing.

Abnormal magnetism has been detected. Move away from any potential source of strong magnetism and try taking a reading again.

[Digital Compass Reading Precautions](#)

- If the display flashes again, it could mean that the watch itself has become magnetized. Move away from any potential source of strong magnetism, perform bidirectional calibration, and then try taking a reading again.

[Calibrating Compass Readings](#)

Q2 [ERR] appears during measurement.

There is a problem with the sensor or there may be a source strong magnetic force nearby. Move away from any potential source of strong magnetism and try taking a reading again. If [ERR] keeps appearing after multiple measurement attempts, contact a CASIO service center or your original retailer.

[Digital Compass Reading Precautions](#)

Q3 [ERR] appears on the display following direction calibration.

[ERR] on the display could indicate a sensor problem.

- If [ERR] disappears after about one second, try performing 2-point calibration again.
- If [ERR] keeps appearing after multiple attempts, contact a CASIO service center or your original retailer.

Q4 Direction information indicated by the watch is different from that indicated by a backup compass.

Move away from any potential source of strong magnetism, perform direction calibration, and then try taking a reading again.

[Calibrating Compass Readings](#)

[Digital Compass Reading Precautions](#)

Q5 Readings at the same location produce different results.
Cannot take readings indoors.

Move away from any potential source of strong magnetism and try taking a reading again.

[Digital Compass Reading Precautions](#)

Location Memory

Q1 Location Memory does not work.

Is the watch paired with a phone?

The watch needs to be paired with a phone for Location Memory to work. Pair the watch with a phone.

🔗 ③ [Pair the watch with a phone.](#)

Are phone settings configured to acquire location information?

The phone needs to be used to allow use of CASIO WATCHES location information for Location Memory to work. Allow use of location information.

Are phone settings configured to acquire GPS information?

You may experience problems acquiring GPS information in environments like the ones described below.

- Where the view of the sky above is narrow
- Near trees or buildings
- Near a train station, airport, or other congested areas
- Locations where there is heavy traffic and radio wave interference
- Near railway aerial wires, high-voltage lines, TV towers, etc.

Signal reception is not possible in the locations described below.

- Where the sky is not visible
- Underground, in a tunnel, under water
- Indoors (Reception may be possible near a window.)
- Near radio communication equipment or other devices that generate electromagnetic waves

Q2 I want to change the recorded location information.

You can use the CASIO WATCHES phone app to edit location information.

🔗 [Configuring Watch Settings](#)

Location Indicator

Q1 Location Indicator does not appear on the display.

Is the watch paired with a phone?

The watch needs to be paired with a phone for Location Indicator to work. Pair the watch with a phone.

🔗 ③ [Pair the watch with a phone.](#)

Is Location Memory information being recorded?

Location information needs to be recorded in Location Memory for Location Indicator to work. Record location information in Location Memory.

🔗 [Recording Your Current Location \(Location Memory\)](#)

Are phone settings configured to acquire location information?

The phone needs to be used to allow use of CASIO WATCHES location information for Location Indicator to work. Allow use of location information.

Are phone settings configured to acquire GPS information?

You may experience problems acquiring GPS information in environments like the ones described below.

- Where the view of the sky above is narrow
- Near trees or buildings
- Near a train station, airport, or other congested areas
- Locations where there is heavy traffic and radio wave interference
- Near railway aerial wires, high-voltage lines, TV towers, etc.

Signal reception is not possible in the locations described below.

- Where the sky is not visible
- Underground, in a tunnel, under water
- Indoors (Reception may be possible near a window.)
- Near radio communication equipment or other devices that generate electromagnetic waves

Barometric Pressure Measurement

Q1 Following a relative barometric pressure reading, the watch's function hand points to [0].

If a reading is outside the allowable barometric pressure measurement range (260 hPa to 1,100 hPa (or 7.65 inHg to 32.45 inHg)), the function hand will point to [0]. If [ERR] is displayed, there may be a problem with the sensor.

🔗 [Checking the Change in Barometric Pressure between Two Readings](#)

Q2 [ERR] appears during measurement.

There may be a problem with the sensor. Try taking another measurement. If [ERR] keeps appearing after multiple measurement attempts, contact a CASIO service center or your original retailer.

Temperature Measurement

Q1 [ERR] appears during measurement.

There may be a problem with the sensor. Try taking another measurement. If [ERR] keeps appearing after multiple measurement attempts, contact a CASIO service center or your original retailer.

World Time

Q1 The time for a World Time City is not correct.

The summer time setting (standard time/summer time) may be wrong.

🔗 [Setting the World Time City](#)

Alarm and Hourly Time Signal

Q1 An alarm does not sound.

Is the watch's battery charged?

Keep the watch exposed to light until it recharges sufficiently.

↙ [Charging](#)

The crown is pulled out.

The alarm will not sound while the crown is pulled out. Push the crown back in to its normal position.

Other than the above.

The alarm's settings may not be configured. Configure the alarm settings.
↙ [Configuring Alarm Settings](#)

Q2 The hourly time signal does not sound.

Is the watch's battery charged?

Keep the watch exposed to light until it recharges sufficiently.

↙ [Charging](#)

The crown is pulled out.

The hourly time signal will not sound while the crown is pulled out. Push the crown back in to its normal position.

Other than the above.

The hourly time signal may be disabled. Enable the hourly time signal.
↙ [Enabling the Hourly Time Signal](#)

Hand Movement and Watch Screen Indications

Q1 I don't know what mode the watch is in.

You can determine the current mode by checking the watch display. Use (B) to navigate between modes.

↙ [Navigating Between Modes](#)

Q2 The second hand is jumping at two-second intervals.

Battery power is low. Keep the watch exposed to light until it recharges sufficiently.

↙ [Charging](#)

Q3 All hands are stopped and buttons do not work.

The battery is dead. Keep the watch exposed to light until it recharges sufficiently.

↙ [Charging](#)

Q4 The hands suddenly start moving at high speed.

This is due to the reason (or one of the reasons) below, and does not indicate malfunction. Simply wait until normal hand movement resumes.

- The watch is recovering from a power saving state.
↙ [Power Saving Function](#)
- A time calibration signal is being received and the time setting is being adjusted.
↙ [Time Adjustment Using a Time Signal](#)
- Watch is connected with a phone to correct its time setting.
↙ [Auto Time Correction](#)

Q5 Hands are stopped and buttons do not work.

The watch is in the charge recovery mode. Wait until the recovery process is complete (for about 15 minutes). The watch will recover more quickly if you place it in a brightly lit location.

Q6 Why is the current time indicated by the watch is off by a certain amount of time (nine hours, three hours and 15 minutes, etc.)?

The city setting is not correct. Select the correct setting.

↙ [Setting a Home City](#)

Q7 The current time indicated by the watch is off by one hour or 30 minutes.

The summer time setting may not be correct. Select the correct setting.

↙ [Setting a Home City](#)

Q8 The time indicated by the hands is different from the displayed time.

Strong magnetism or impact can cause the hands to go out of alignment. Adjust hand alignment.

↙ [Adjusting Hand Alignment](#)

- Check the information below to find out how to align the hands manually.

↙ [Hand Alignment Adjustment](#)

Crown Operations

Q1 Nothing happens when I rotate the crown.

If you do not perform any operation for at least two minutes after pulling out the crown (approximately 30 minutes in the case of hand alignment), crown operations will automatically become disabled. If that happens, push the crown back in and then pull it out again.

↙ [Using the Crown](#)

Charging

Q1 The watch does not work even though it is exposed to light.

The watch stops operating whenever the battery goes dead. Keep the watch exposed to light until it recharges sufficiently.

[🔍 Checking the Charge Level](#)

Q2 [RECOVER] is flashing on the display.

The watch is in the charge recovery mode. Wait until the recovery process is complete (about 15 minutes). The watch recovers more quickly if you place it in a brightly lit location.

- If a sensor measurement operation, illumination and/or other power-intensive functions are used within a short period of time, the charging capacity of the battery drops and causes the watch to go into a charge recovery mode. Function availability is temporarily limited, but functionality returns after the battery recovers.

[🔍 Checking the Charge Level](#)

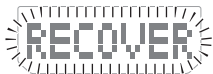

Q3 [CHARGE] is flashing on the digital display.

The charge level of the watch is extremely low. Immediately expose the watch to light to charge it.

[🔍 Checking the Charge Level](#)

Other

Q1 I can't find the information I need here.

Visit the website below.

<https://world.casio.com/support/>

Precautions

Operating Precautions

● Water Resistance

- The information below applies to watches with WATER RESIST or WATER RESISTANT marked on the back cover.

Water Resistance Under Daily Use

Marking on watch front or on back cover	No BAR mark
---	-------------

Example of Daily Use

Hand washing, rain	Yes
Water-related work, swimming	No
Windsurfing	No
Skin diving	No

Enhanced Water Resistance Under Daily Use

5 Atmospheres

Marking on watch front or on back cover	5BAR
---	------

Example of Daily Use

Hand washing, rain	Yes
Water-related work, swimming	Yes
Windsurfing	No
Skin diving	No

10 Atmospheres

Marking on watch front or on back cover	10BAR
---	-------

Example of Daily Use

Hand washing, rain	Yes
Water-related work, swimming	Yes
Windsurfing	Yes
Skin diving	Yes

20 Atmospheres

Marking on watch front or on back cover	20BAR
---	-------

Example of Daily Use

Hand washing, rain	Yes
Water-related work, swimming	Yes
Windsurfing	Yes
Skin diving	Yes

- Do not use your watch for scuba diving or other types of diving that requires air tanks.

- Watches that do not have WATER RESIST or WATER RESISTANT marked on the back cover are not protected against the effects of sweat. Avoid using such a watch under conditions where it will be exposed to large amounts of sweat or moisture, or to direct splashing with water.

- Even if a watch is water resistant, note the usage precautions described below. Such types of use reduce water resistance performance and can cause fogging of the glass.

- Do not operate the crown or buttons while your watch is submersed in water or wet.
- Avoid wearing your watch while in the bath.
- Do not wear your watch while in a heated swimming pool, sauna, or any other high temperature/high humidity environment.
- Do not wear your watch while washing your hands or face, while doing housework, or while performing any other task that involves soaps or detergents.

- After submersion in seawater, use plain water to rinse all salt and dirt from your watch.

- To maintain water resistance, have the gaskets of your watch replaced periodically (about once every two or three years).

- A trained technician will inspect your watch for proper water resistance whenever you have its battery replaced. Battery replacement requires the use of special tools. Always request battery replacement from your original retailer or from an authorized CASIO service center.

- Some water-resistant watches come with fashionable leather bands. Avoid swimming, washing, or any other activity that causes direct exposure of a leather band to water.

- The inside surface of the watch glass may fog when the watch is exposed to a sudden drop in temperature. No problem is indicated if the fogging clears up relatively quickly. Sudden and extreme temperature changes (such as coming into an air conditioned room in the summer and standing close to an air conditioner outlet, or leaving a heated room in the winter and allowing your watch to come into contact with snow) can cause it to take longer for glass fogging to clear up. If glass fogging does not clear up or if you notice moisture inside of the glass, immediately stop using your watch and take it to your original retailer or to an authorized CASIO service center.

- Your water-resistant watch has been tested in accordance with International Organization for Standardization regulations.

● Band

- Tightening the band too tightly can cause you to sweat and make it difficult for air to pass under the band, which can lead to skin irritation. Do not fasten the band too tightly. There should be enough room between the band and your wrist so you can insert your finger.

- Deterioration, rust, and other conditions can cause the band to break or come off of your watch, which in turn can cause band pins to fly out of position or to fall out. This creates the risk of your watch falling from your wrist and becoming lost, and also creates the risk of personal injury. Always take good care of your band and keep it clean.

- Immediately stop using a band if you even notice any of the following: loss of band flexibility, band cracks, band discoloration, band looseness, band connecting pin flying or falling out, or any other abnormality. Take your watch to your original retailer or to a CASIO service center for inspection and repair (for which you will be charged) or to have the band replaced (for which you will be charged).

● Temperature

- Never leave your watch on the dashboard of a car, near a heater, or in any other location that is subject to very high temperatures. Do not leave your watch where it will be exposed to very low temperatures. Temperature extremes can cause your watch to lose or gain time, to stop, or otherwise malfunction.
- Leaving your watch in an area hotter than +60 °C (140 °F) for long periods can lead to problems with its LCD. The LCD may become difficult to read at temperatures lower than 0 °C (32 °F) and greater than +40 °C (104 °F).

● Impact

- Your watch is designed to withstand impact incurred during normal daily use and during light activity such as playing catch, tennis, etc. Dropping your watch or otherwise subjecting it to strong impact, however, can lead to malfunction. Note that watches with shock-resistant designs (G-SHOCK, BABY-G, G-MS) can be worn while operating a chain saw or engaging in other activities that generate strong vibration, or while engaging in strenuous sports activities (motocross, etc.)

● Magnetism

- The hands of analog and combination (analog-digital) watches are moved by a motor that uses magnetic force. When such a watch is close to a device (audio speakers, magnetic necklace, cell phone, etc.) that emits strong magnetism, the magnetism can cause timekeeping to slow down, speed up, or stop, resulting in the incorrect time being displayed.
- Timekeeping accuracy may be affected if the watch itself becomes magnetized. Also, very strong magnetism (from medical equipment, etc.) should be avoided because it can cause malfunction of your watch and damage to electronic components.

● Electrostatic Charge

- Exposure to very strong electrostatic charge can cause your watch to display the wrong time. Very strong electrostatic charge even can damage electronic components.
- Electrostatic charge may cause temporary blotching in blank areas of the LCD.

● Chemicals

- Do not allow your watch to come into contact with thinner, gasoline, solvents, oils, or fats, or with any cleaners, adhesives, paints, medicines, or cosmetics that contain such ingredients. Doing so can cause discoloration or damage to the resin case, resin band, leather, and other parts.

● Storage

- If you do not plan to use your watch for a long time, thoroughly wipe it free of all dirt, sweat, and moisture, and store it in a cool, dry place.

● Resin Components

- Allowing your watch to remain in contact with other items or storing it together with other items for long periods while it is wet can cause color on resin components to transfer to the other items, or the color of the other items to transfer to the resin components of your watch. Be sure to dry off your watch thoroughly before storing it and make sure it is not in contact with other items.
- Leaving your watch where it is exposed to direct sunlight (ultraviolet rays) for long periods or failure to clean dirt from your watch for long periods can cause it to become discolored.
- Friction caused by certain conditions (strong external force, sustained rubbing, impact, etc.) can cause discoloration of painted components.
- If there are printed figures on the band, strong rubbing of the printed area can cause discoloration.
- Leaving your watch wet for long periods can cause fluorescent color to fade. Wipe the watch dry as soon as possible after it becomes wet.
- Semi-transparent resin parts can become discolored due to sweat and dirt, and if exposed to high temperatures and humidity for long periods.
- Daily use and long-term storage of your watch can lead to deterioration, breaking, or bending of resin components. The extent of such damage depends on usage conditions and storage conditions.

● Leather Band

- Allowing your watch to remain in contact with other items or storing it together with other items for long periods while it is wet can cause the color of the leather band to transfer to the other items or the color of the other items to transfer to the leather band. Be sure to dry off your watch thoroughly with a soft cloth before storing it and make sure it is not in contact with other items.
- Leaving a leather band where it is exposed to direct sunlight (ultraviolet rays) for long periods or failure to clean dirt from a leather band for long periods can cause it to become discolored.

CAUTION:

Exposing a leather band to rubbing or dirt can cause color transfer and discoloration.

● Metal Components

- Failure to clean dirt from metal components can lead to formation of rust, even if components are stainless steel or plated. If metal components exposed to sweat or water, wipe thoroughly with a soft, absorbent cloth and then place the watch in a well-ventilated location to dry.
- Use a soft toothbrush or similar tool to scrub the metal with a weak solution of water and a mild neutral detergent, or with soapy water. Next, rinse with water to remove all remaining detergent and then wipe dry with a soft absorbent cloth. When washing metal components, wrap the watch case with kitchen plastic wrap so it does not come into contact with the detergent or soap.

● Bacteria and Odor Resistant Band

- The bacteria and odor resistant band protects against odor generated by the formation of bacteria from sweat, which ensures comfort and hygiene. In order to ensure maximum bacteria and odor resistance, keep the band clean. Use an absorbent soft cloth to thoroughly wipe the band clean of dirt, sweat, and moisture. A bacteria and odor resistant band suppresses the formation of organisms and bacteria. It does not protect against rash due to allergic reaction, etc.

● Liquid Crystal Display

- Display figures may be difficult to read when viewed from an angle.

● Watch with Data Memory

- Allowing the battery to go dead, replacing the battery, or having your watch repaired can cause all data in watch memory to be lost. Note that CASIO Computer Co., Ltd. assumes no responsibility for any damages or losses caused by data lost due to malfunction or repair of your watch, replacement of the battery, etc. Be sure to keep separate written copies of all important data.

● Watch Sensors

- A watch sensor is a precision instrument. Never try to take it apart. Never try to insert any objects into the openings of a sensor, and take care to ensure that dirt, dust, or other foreign matter does not get into it. After using your watch where it has been immersed in saltwater, rinse it thoroughly with fresh water.

Note that CASIO Computer Co., Ltd. assumes no responsibility for any damage or loss suffered by you or any third party arising through the use of your watch or its malfunction.

User Maintenance

● Caring for Your Watch

Remember that you wear your watch next to your skin, just like a piece of clothing. To ensure your watch performs at the level for which it is designed, keep it clean by frequently wiping with a soft cloth to keep your watch and band free of dirt, sweat, water and other foreign matter.

- Whenever your watch is exposed to sea water or mud, rinse it off with clean fresh water.
- For a metal band or a resin band with metal parts, use a soft toothbrush or similar tool to scrub the band with a weak solution of water and a mild neutral detergent, or with soapy water. Next, rinse with water to remove all remaining detergent and then wipe dry with a soft absorbent cloth. When washing the band, wrap the watch case with kitchen plastic wrap so it does not come into contact with the detergent or soap.
- For a resin band, wash with water and then wipe dry with a soft cloth. Note that sometimes a smudge like pattern may appear on the surface of a resin band. This will not have any effect on your skin or clothing. Wipe with a cloth to remove the smudge pattern.
- Clean water and sweat from a leather band by wiping with a soft cloth.
- Not operating a watch crown, buttons, or rotary bezel could lead to later problems with their operation. Periodically rotate the crown and rotary bezel, and press buttons to maintain proper operation.

● Dangers of Poor Watch Care

Rust

- Though the metal steel used for your watch is highly rust-resistant, rust can form if your watch is not cleaned after it becomes dirty.
 - Dirt on your watch can make it impossible for oxygen to come into contact with the metal, which can lead to breakdown of the oxidization layer on the metal surface and the formation of rust.
- Rust can cause sharp areas on metal components and can cause band pins to fly out of position or to fall out. If you ever notice any abnormality immediately stop using your watch and take it to your original retailer or to an authorized CASIO service center.
- Even if the surface of the metal appears clean, sweat and rust in crevasses can soil the sleeves of clothing, cause skin irritation, and even interfere with watch performance.

Premature Wear

- Leaving sweat or water on a resin band or bezel, or storing your watch in an area subject to high moisture can lead to premature wear, cuts, and breaks.

Skin Irritation

- Individuals with sensitive skin or in poor physical condition may experience skin irritation when wearing a watch. Such individuals should keep their leather band or resin band particularly clean. Should you ever experience a rash or other skin irritation, immediately remove your watch and contact a skin care professional.

Battery

- The special rechargeable battery used by your watch is not intended to be removed or replaced by you. Use of a rechargeable battery other than the special one specified for your watch can damage your watch.
- The rechargeable (secondary) battery is charged when the solar panel is exposed to light, so it does not require regular replacement as the primary battery requires. Note, however, that long use or operating conditions can cause the capacity or charging efficiency of the rechargeable battery to deteriorate. If you feel that the amount of operation provided by charging is too short, contact your original retailer or CASIO service center.

Mobile Link Precautions

- **Legal Precautions**
 - This watch complies with or has received approval under the radio laws of various countries and geographical areas. Using this watch in an area where it does not comply with or has not received approval under applicable radio laws may be a criminal offense. For details, visit the CASIO Website.
<https://world.casio.com/ce/BLE/>
 - Use of this watch inside of aircraft is restricted under the aviation laws of each country. Be sure to follow the instructions of airline personnel.
- **Precautions when using Mobile Link**
 - When using this watch in combination with a phone, keep the watch and phone close to each other. A range of two meters is recommended as a guideline, but the local environment (walls, furniture, etc.), the structure of a building, and other factors may require a much closer range.
 - This watch can be affected by other devices (electrical devices, audio-visual equipment, office equipment, etc.) In particular, it can be affected by operation of a microwave oven. The watch may not be able to communicate normally with a phone if a microwave oven is operating nearby. Conversely, this watch may cause noise in radio reception and the video image of a TV.
 - Bluetooth of this watch uses the same frequency band (2.4 GHz) as wireless LAN devices, and use of such devices in close proximity of this watch may result in radio interference, slower communication speeds and noise for the watch and the wireless LAN device, or even communication failure.

● Stopping Radio Wave Emission by This Watch

The watch is emitting radio waves whenever the second hand is pointing to .

Also, the watch connects with a phone automatically, as described below.

- Auto Time Correction (4 times per day)
- While Route Log is enabled (data transferred each hour)

When in a hospital, on an aircraft, or in any other area where the use of radio waves is not allowed, use the operation below to stop radio wave generation.

- **Stopping Radio Wave Generation**
Press any button to terminate the Bluetooth connection.

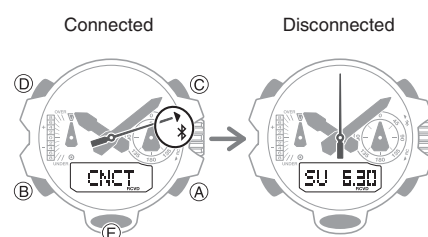

- **Disabling Auto Time Correction**
Configure CASIO WATCHES phone app settings to disable synchronization between the watch and phone.
 [Using the Watch in a Medical Facility or Aircraft](#)