

# INSTALLATION AND INSTRUCTION MANUAL

## GAS AND ELECTRIC BUILT IN OVENS

Models:

EMF61MVI, EF64MEI,

GF65MEN, GF65MEI, GMF61MVI, GF64MEI, GF69MEI

### IMPORTANT:

This oven is for domestic applications. It is NOT suitable for commercial applications of any kind. Do not install the oven if there is any doubt. Contact Glem Gas Australasia if you require clarification.

This cooker must be installed by a qualified & licensed installer in accordance with these instructions. If you do not retain proof of correct installation your warranty will be voided.

If your oven is found to be incorrectly installed you will be liable for all service costs. If a warranty call is made and the oven is found to be incorrectly installed you will be charged for the service call even if the oven is not repaired. We will not service an incorrectly installed oven.

 **EMILIA**  **GLEM**



Dear Customer,

Thank you for purchasing our product. This manual has been written to assist you and instruct you in the operation of your oven. It will help you get the best performance and make full use of the features of your oven.

The safety precaution and warnings are listed for your safety and the safety of others when operating your oven. Please keep this manual in a safe place for future reference.

This oven has been designed for use in cooking of domestic (household) food. Any form of usage other than cooking food is considered dangerous and inappropriate. The manufacture accepts no responsibility in the event problems caused by improper use, incorrect use or faulty installation. A signed installation certificate indicating the installers licence number and details is required for warranty service.

### **OVEN SHOULD NOT BE USED IN A COMMERCIAL ENVIRONMENT**

This includes semi commercial, commercial or communal applications such as clubs and schools.

NOTE: Model number details are on the inside of the door. Record them here for your records.

Model:	Serial No.:
--------	-------------

Emilia and Glem ovens are manufactured in the Glem Gas factory in Modena, Italy. They have been designed and constructed to meet the following Australian Safety Standards:

AS 4551 – *Requirements for Domestic Gas cooking ovens*  
 AS/NZS 60335-1 - *General Requirements for Domestic electrical ovens*  
 AS/NZS 60335-2-6 - *Particular Requirements for Domestic electrical cooking ovens*  
 AS/NSZ 1044 - *Electromagnetic Compatibility Requirements.*

Surface temperatures for all components comply with the standards. Even so certain parts of an oven become very hot during and after use. A cooling fan operates during the cooking cycle and afterwards until the oven cools.

## SAFETY HINTS AND USAGE TIPS

### 1) OVEN DOOR

Keep children away from the glass oven door while cooking is in progress: if touched, the glass could cause burns. Don't let children sit on or play with the oven door. Do not use the drop down door as a stool to reach above cabinets. Do not rest baking dishes or put any weight on the oven door.

### 2) GRILL - ALL MODELS

The grill is electric. Grilling must always be done with the oven door closed.

### 3) USE OF POT HOLDER GLOVES - ALL MODELS

Make sure that burners and oven trays are cool before touching them unless you are wearing oven gloves.

### 4) DO NOT MODIFY THIS OVEN

Do not modify or attempt to modify the technical characteristics of this oven, as this may present a danger to you and those around you.

### 5) USE THE CORRECT COOKING VESSELS

For cooking food, use only plates and trays resistant to high temperatures.

### 6) DO NOT LINE THE OVEN WALLS OR FLOOR WITH FOIL

Never place aluminium foil directly on the oven racks, floor or wall as the accumulated heat may damage the surface.

### 7) KEEP YOUR OVEN CLEAN

To avoid flare ups or fires within your oven we suggest keeping the oven cavity as clean possible. Particularly after roasting something such as a chicken we recommend wiping the oven out thoroughly. Place a tray of water on a lower shelf to assist in reducing fat build ups.

### 8) PREHEAT FIRST

Preheating the oven first before starting cooking is advised. On a gas oven there is no indicator light. A gas oven will reach 200C after 10-12 minutes.

## GENERAL WARNINGS

- This oven must not be used by persons (including children) whose physical, sensory or mental capacities are reduced or by persons without experience or instruction, unless under supervision of a responsible person or with appropriate instruction on the use of the oven.
- Young children should be supervised to ensure they do not play with the oven.
- **WARNING:** Accessible parts may become hot during use. To avoid burns young children should be kept away.
- **DO NOT USE** polyunsaturated oils with cooking in the oven. The type of oil can cause heavy deposits inside the oven.
- **DO NOT USE** a steam cleaner to clean the oven or use any caustic cleaners to clean the oven.
- **DO NOT** use harsh abrasive cleaners or sharp metal scrapers to clean the oven door since they can scratch the surface, which may result in shattering of the glass.
- **DO NOT** spray aerosols in the vicinity of this oven while it's operating.
- During use the oven becomes hot. Care should be taken to avoid touching heating elements inside the oven. Please keep children away from the oven.
- **DO NOT** store flammable materials in the oven.
- **ALWAYS** keep the oven clean to avoid fires
- After having used the oven, ensure that all knobs are in the OFF position.
- This oven is unsuitable for use in marine craft, caravans or mobile homes.
- If the oven fails to operate correctly, call Glem Gas Australasia Pty Ltd or their appointed agent for service. **DO NOT ATTEMPT REPAIRS YOURSELF.**

Glem Gas Australasia Pty. Ltd. does not accept any responsibility for any damage coming from inappropriate, incorrect and irrational use. For more detailed information, refer to the Warranty Card. Contact Glem Gas Australasia Pty. Ltd. on 02 9721 2755 for all service enquiries.

*At our internet site [www.emiliaglem.com.au](http://www.emiliaglem.com.au) you will find details of our latest products and a source of useful and additional information.*

*With a view to continuously improving our products, we reserve the right to make modifications to their technical, functional or aesthetic characteristics in parallel with technological developments.*

## BEFORE USING FOR THE FIRST TIME

Remove all packing material and literature from the oven before connecting the gas and electricity supplies.

Make sure all plastic has been removed before use. Some models have trays with a protective coating; make sure the plastic coating has been removed. Clean the interior of the oven and all accessories with soap and water and dry them carefully.

Switch on the empty oven on maximum to eliminate grease residues from manufacturing. There may be a slight odour at this time. Run the oven on maximum for a period of 1 hour. Open the kitchen windows at this time. If this odour lingers use the oven and the odour will dissipate.

The oven is fitted with 4 guides for positioning trays and racks at different heights.

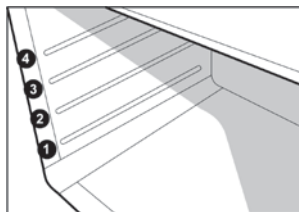

The oven comes with 2 RACKS:  
Used to support containers for cooking food.

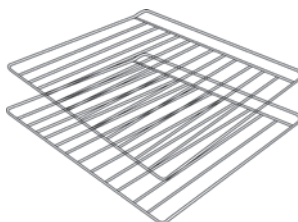

The oven comes with a grill tray and rack insert:

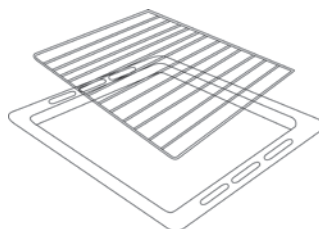

## Removing & Installing the Oven Shelves

1. The shelves in your oven have been designed with safety stops.
2. Slide the oven shelves towards you until they reach the front stop tilt them up at the front to clear the side supports and lift them clear. To install them reverse the procedure.

# GAS OVEN

## DESCRIPTION OF CONTROLS

Use the controls and knobs on the oven instrument panel to select the various functions.

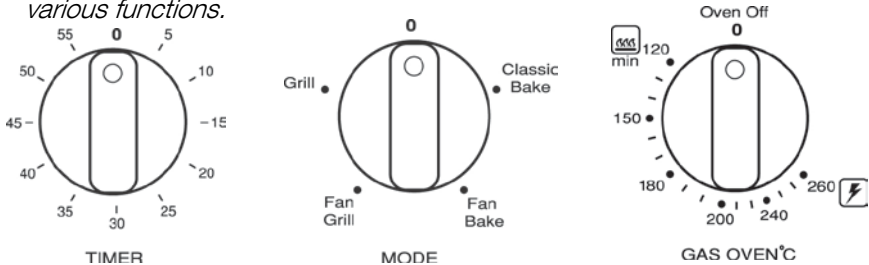

**'TIMER':** Minute counter – rotate the knob to the desired time up to 60 minutes and a bell will ring at the end of the time period. For very short time periods turn the knob past the point you want and then back to it to load the timer mechanism. Some models may have an electronic timer. Refer to electronic timer instructions in this book.

**'MODE':** Function selector – selects the oven functions.

**Position 0 :** Light off. The oven functions in Classic Bake mode without the light - low power consumption baking.

**Classic bake:** The oven operates without fan assistance, light on.

**Fan Bake:** Oven operates with fan assistance. Light on.

**Fan Grill:** The electric grill operates with the fan assistance. Leave the door closed while grilling.

**Grill:** The electric grill operates without fan assistance. Leave the door closed while grilling. "Grill" indicator light operates when grilling.

**'GAS OVEN':** Selects the temperature most suitable to the specific cooking requirements. The oven is equipped with a gas thermostat. Its purpose is to keep the temperature as a constant heat. The oven is fitted with electronic spark ignition and a safety gas shut off device that shuts off the gas if the flame fails for any reason. Top position 0 switches the oven off.

## GAS OVEN

### OVEN OPERATION

#### Lighting the Gas Oven

The oven burner must be ignited with the DOOR OPEN. There is a safety device which prevents the oven lighting unless the door is in the open position

1. Open the oven door and remove the grill tray and leave it out.
2. Press the 'GAS OVEN' knob and rotate it anti-clockwise to the maximum setting. The electronic ignition is activated automatically when the knob is depressed.
3. Keep knob depressed for about 15 seconds after the flame has lit. Always view the flame during the lighting procedure for safety. There is a hole in the base for viewing the burner.
4. Release the knob and select the desired temperature. Wait a minute and close the door gently.

The oven burner is fitted with a safety valve which blocks the gas supply if there is a failure in igniting the burner or if the flame is extinguished.

#### Manual Lighting of the Oven

In case of ignition malfunction or an electricity failure depress and rotate the 'GAS OVEN' control knob in an anti clockwise direction to reach the maximum temperature. Keep the knob depressed while lighting.

Light a match and place it into the hole in the base plate. Once the burner has lit keep the knob depressed for 15 seconds.

**When lighting the oven for the first time – if the electronic ignition fails to light the oven – light the oven manually and run the oven by running it in at 200 degrees for 20 minutes. This will burn in the burner and remove any moisture that may have prevented the oven from lighting electronically.**

### OVEN PREHEATING

Once the oven is lit set the oven knob to the required temperature and wait for about 20 minutes before introducing the food. Comply with the cooking indication chart in these instructions and to get the best out of the oven choose the right shelf position. *On a gas oven there is no temperature indicator light.*

## ELECTRIC OVEN

### DESCRIPTION OF CONTROLS

Electric ovens have the advantage of being able to offer different types of heat to suit many cooking applications. Models vary according to the functions available.

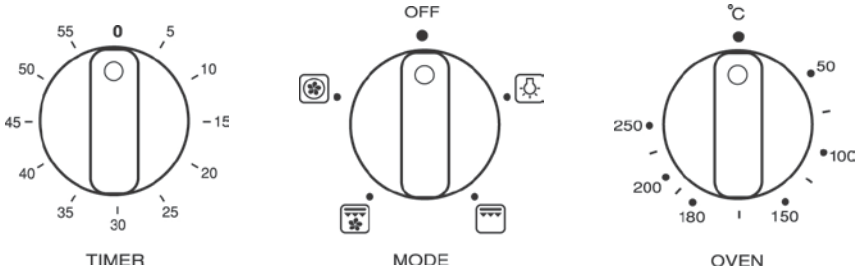

**TIMER:** Minute counter – rotate the knob to the desired time up to 60 minutes and a bell will ring at the end of the time period. For very short time periods turn the knob past the point you want and then back to it to load the timer mechanism. Some models may have an electronic timer. Refer to electronic timer instructions in this book.

**'MODE':** Function selector – selects the oven functions. The oven functions vary for each model.

**'TEMP':** This thermostat pilot light switches on and off during cooking to show that the heating cycles are taking place properly. For Static and fan forced mode, the oven must always be preheated. For optimum results, try to open the oven door as little as possible, opening the door lowers the temperature suddenly and affects the thermostat cycles. When cooking on different shelves simultaneously, put all containers in the centre of the shelves.

**'OVEN':** The oven temperature is controlled by a thermostat. Select the required temperature for the cooking task. The indicator light goes out when the temperature is reached.

### OPERATING THE OVEN

Remove the grill tray. Choose a function using the **MODE** switch. Turn it to the symbol of the cooking function you wish to use. Then rotate the thermostat knob to the desired temperature. Wait until the thermostat indicator light goes out. This indicates that the oven has reached temperature. Then introduce the food to be cooked. Over the page is a description of the functions that may be on your oven.

## OVEN FUNCTIONS – Electric Oven (functions vary according to model)



**FAN FORCED:** The heat is generated by a circular element and distributed by a fan. Fast and efficient and allows for baking on more than one shelf. **Some foods may need to be rotated using this function.**



**CLASSIC BAKE:** Heat applied from the top and bottom elements provides traditional baking conditions. Suitable for baking on one shelf only. Best for foods such as roasts, spare ribs, meringues.



**FAN ASSISTED:** Heat applied from top and bottom elements assisted by a fan. Distributes the air very evenly and is ideal when baking on more than one shelf. Great for large quantities or large volume food such as turkeys, chickens, cakes etc.



**ELECTRIC GRILL:** On some models this is the inner part of the upper element. Always grill with the door closed. Recommended operation is for 30 minutes only, great for toasting, browning foods etc.



**FAN ASSISTED GRILL:** A fan operates with the grill ideal for cooking thicker cuts of meat. Great for steaks. Always grill with the door closed.



**DOUBLE GRILL (some models):** The double grill uses the inner and outer elements for larger grilling area, only the inner element glows. Grill with the door closed.



**PIZZA:** Fan element operates with the bottom element to create an ideal environment for baking pizza.



**DEFROST:** Fan operates which shortens defrosting times.



**PREHEAT:** A time saving function that quickly preheats the oven to a preset 160C. You can then set your desired cooking function.

## COOKING TABLE

Dish	Shelf Position 1=top		Temp Degrees C		Cooking Time Minutes
	Static	Fan Oven	Static	Fan Oven	
<b>Cakes</b>					
Chocolate cake	2	2 3	180-190	180	35-40
Creme Caramel	3	2 3	130-150	130	30-35
Cup Cakes	1	1 2	190-200	180-190	18-20 (35 cakes)
Fruit Cake	3	2 3	175-190	165-180	35-35
Jam Tarts	2	2 3	185-200	185-200	40-50
Nut Cake	3	2 3	190-200	180-190	40-45
Scones	1	1 2	190-230	180-190	17 (35 scones)
Sponge Cake	2	2 3	195-210	185	35-45
Swiss Roll	2	2 3	195-200	185-200	35-45
<b>Pastries</b>					
Brioches	3	2 3	190-200	180-190	25-30
Cookies	2	2	180	165	20
Pastry	3	2 3	220-240	190-220	18
Puff Pastry	3	2 3	230-250	200-230	10-15
<b>Pizza and Bread</b>					
Bread	3	3	215-230	215-230	40-50
Muffins	3	2	205-220	185-200	25-35
Pizza	2	2	215-230	195-210	20-30
<b>Baked Pasta</b>					
Lasagne	2	2 3	185-200	165-180	30-40
Macaroni	2	2 3	225-240	200-205	35-45
Pasta Bake	2	2 3	225-240	200-205	35-45
Vegetable bake	2	2 3	185-200	165-180	30-40
Baked in foil	2	1 2 3	215-230	195-210	20-25
Fillets or steak	2	1 2 3	175-190	155-170	15-20
Roast	2	1 2 3	195-210	175-190	25-30
Stewed fish	2	1 2 3	180-190	165-180	15-20
<b>Roast Meats</b>					
Beef 1kg	3	2 3 4	220-250	200-220	50-60
Lamb 1kg	3	2 3 4	190-220	180-200	50-60
Pork 1 kg	3	2 3 4	190-220	180-200	60-80
Veal 1 kg	3	2 3 4	190-220	180-200	60-80
<b>Roast Poultry</b>					
Chicken	3	2 3 4	205-215	195-210	40
Duck	3	2 3 4	210-220	195-210	120-180
Goose	3	2 3 4	210-220	195-210	120
Turkey	3	2 3 4	215-230	195-210	220
<b>Roast Game</b>					
Rabbit	3	2 3 4	215-235	200-220	40
Venison	3	2 3 4	190-220	180-200	50-60
Pheasant	3	2 3 4	205-215	195-210	40-50

### Cooking Notes:

- The information provided is purely a guideline. Modify to suit experience, eating habits and personal taste.
- The times indicated in the table do not include preheating of the oven, which is always recommended.
- The time and temperature indicated refer to average quantities of food: meats 1/1.5kg, dough for confectionery, pizza, bread 0.5/0.8kg.
- Information in brackets with regard to shelves indicates the shelf to be used when cooking several dishes together.
- When cooking on different shelves simultaneously put all containers in the centre of their shelves.

**NOTE: All ovens are different and your new oven may perform differently to your previous model.**

Shelf positions and operating temperatures may vary to what you are accustomed. It sometimes takes a few uses to become fully familiar with the characteristics of your new oven.

### **COOLING FAN FEATURE**

Our ovens have a cooling fan that continues to run after the end of the cooking cycle. The fan will stop once the residual heat in the oven has dissipated.

It assists in keep the outside of your oven cool and prevents damage to surrounding surfaces.

### **ACQUA CLEAN FEATURE**

The oven model GF69MEI has the ACQUACLEAN feature. Add a small amount of water into the grill tray and turn on the oven. Wait for the oven to steam up. Open the door carefully to avoid the steam that escapes out the top and then simply wipe the oven clean. It is remarkable.

## BAKING TROUBLE SHOOTING

All ovens are different and it can take some time to learn the cooking characteristics of your new oven. Listed below are some common problems, causes and suggested solutions that may assist.

Problem	Cause	Solution
Cooking unevenly	Wrong location in oven Wrong size tray Heat variations in oven	Use shelf to place food in centre of oven Try alternatives Turn food while cooking
Burning on top	Oven not preheated  Aluminium foil in oven Food too close to top of oven	Turn oven on and wait for oven to reach temperature before placing food in the oven Remove foil Place on a lower shelf
Burning on bottom	Temperature too high Baking tins too large Baking tins are dark coloured Food too low in the oven Opening the door too frequently	Lower the temperature Use correct sized tins or reduce temperature Use light coloured tins or reduce temperature Raise to a higher shelf position Do not open the door too often while cooking
Meat and potatoes not browning	Poor heat distribution on food	Try to place the food on a rack to allow the heat to distribute evenly around the food
Cakes have hard split crusts and appear over cooked	Temperature too high Food too high in the oven Cake tin too deep Cake tin a dark colour	Lower the temperature Use a lower shelf position Use correct size tin Use a light coloured tin
Cakes sunk in centre and seem under cooked	Temperature too low Cooking time is too short Door opened too early	Increase temperature Increase length of cooking time Do not open door until late in the cycle

For more ideas and information go to [www.glemgas.com.au](http://www.glemgas.com.au)

## GRILL OPERATION – NOTE: Electric grill on all models

The grill is operated by the 'MODE' control knob. The oven door must be closed during grill operation. The grill element is an infrared type, which provides an even controlled heat.

Always grill with the oven door closed - the oven and grill cannot be operated at the same time.

*NOTE: If the oven thermostat knob is turned accidentally during the operation of the electric grill, a safety device will stop the functioning of the grill.*

### GRILLING TIPS:

- Before introducing food inside the oven it is advisable to pre-heat the oven for at least 5 minutes.
- Place the food to be grilled on the appropriate rack or tray, positioning it at the highest level depending on the volume of food and the amount of direct heat you want to apply.
- Place a dripping pan in the bottom compartment of the oven to collect fats.
- Using a standard shelf with a drip tray below filled with some water will avoid smoke build-up coming from burnt fat and at the same time assist in keep the food moist.
- Depending on the type of food cooked (meat, fish, poultry, etc.), it is necessary to turn it over in order to expose both sides to the heat from the elements.
- The grilling process should not exceed 30 minutes.

### **USING THE ELECTRONIC TIMER**

#### Non Programmer Electronic Timer

*Glem models – GMF61MVI and GF64MEI*



#### **Setting the Clock**

When the oven is first connected, or after a power failure, '0.00' will flash on the display.

To set the clock, push the middle set button and the (+) or (-) buttons immediately to the desired time. The time of day will be saved after 10 seconds.

#### **Using the Timer**

The timer can be set for a maximum period of 99 minutes and a minimum of 10 seconds.

To set the timer just push the (+) or (-) button until you have set the required time in minutes and seconds.

When the timer is operating the timer on indicator will be lit.

Once the pre-set time has elapsed, the timer will beep Push the SET button to switch off.

*The (-) button can also be used to change the volume of the beep.*

#### Programmable Electronic Timer

Glem Models- GF65MEI, GF65MEN, GF69MEI



**You need to set the timer before using your oven.** It will flash on and off when you first connect the oven. This is normal.

#### **Setting the Time of Day**

Set the time of day before using your oven.

1. Press the '+' and '-' buttons at the same time & hold them down.
2. The centre dot will start to flash on and off.
3. While it is flashing use the '+' and '-' to set the time. If you hold your finger the numbers will scroll through much faster. The timer has a 24 hour clock display.
4. One you reach the correct time of day leave it for a few seconds, it will beep and the clock will be set.

### Setting the Minute Countdown Timer

The minute countdown timer works independently of the oven and is handy for checking the time periods for all cooking tasks.

1. Press the MENU button until the screen changes and then let go.
  2. Set the countdown time you want by pressing the '+' or '-'. The time is in minutes, not seconds.
  3. There will be a beep and the timer is set. You will see the time of day and the bell icon on the clock display.
  4. Once the countdown is completed a beeper will sound. Press any button to switch off the beeper. To stop the bell icon flashing press and hold the MENU button.
- If you want to check the amount of time remaining in this mode just press and hold the MENU button once.
  - If you want to cancel at any time press and hold the MENU until the screen changes and then hold the "+" and "-" at the same time. The timer will be cancelled.

**Setting the Automatic Oven Switch Off** – this function allows you to set the length of cooking time.

1. Switch the oven to the function & temperature you want to use.
  2. Press and hold the MENU button and then press it again. The display shows 'DUR' (for duration).
  3. Press '+' to set the desired cooking time. Wait for a moment and the timer will beep and return to the time of day.
  4. Once the time period is complete the oven will switch off and the beeper will sound.
  5. Press any button to switch off the beeper.
- If you wish to cancel at any time during the cooking period press and hold the MENU button, press it again and then the '+' and '-' at the same time.
  - Do not forget to switch off the oven and temperature setting at the end of the cooking cycle.

### Programming the Oven to Switch Off at a Certain Time of Day

Sometimes it is handy to set the time of day you want to finish cooking. This feature allows you to set the length of time you want the oven to run and the time of day when you would like the oven to turn off.

1. Press and hold the MENU button and then press again. The display shows 'DUR' (for duration).
2. Press '+' to set the desired cooking time.
3. Press MENU button once to show 'END' in the screen. This is where you set the time of day that you want the oven to stop cooking.
4. Press the '+' button to set the time of day when you wish the cooking to stop.
5. Turn on the oven and select the oven function. Of course the oven doesn't switch on yet.
6. The oven will switch off at the end of the period and the beeper will sound.
  - Press any button to switch off the beeper.
  - If you wish to cancel the program at any time press and hold the MENU button then press MENU twice and then the "+" and "-" as the same time.
  - Do not forget to switch off the oven and temperature setting at the end of the cycle.

### Programming Sample

I wish to use fan forced setting at 180 degree to cook for 45 minutes including heat up and to finish cooking at 12.30 in time for lunch.

1. Press MENU and hold and then press again – 'DUR' displays.
2. Press '+' to 45 minutes.
3. Press MENU once – 'END' displays.
4. Press '+' to 12.30
5. Press MENU once to go back to time of day.
6. Select fan forced function.
7. Set temperature to 180 degrees.

### HANDY HINTS

- Remember to include the heat up time when programming the oven.
- The oven programmer only operates on electric ovens.
- Remember to turn off the oven at the end of an automatic cycle.

## CLEANING AND MAINTENANCE

**WARNING:** the oven must be kept clean, as a build up of fat constitutes a fire risk.

1. Cleaning of Stainless Steel: In order that your oven retains its new appearance, care should be taken to protect the stainless steel finish. Never use gritty or abrasive sponges. We highly recommend stainless steel cleaners and protectors. Stubborn stains can be removed by soaking in hot water and stains can be prevented by using a clean cloth soaked in soapy water before a spillage becomes cold or dries up. Acid materials like milks, vinegar, citrus juice can damage the most resistant surfaces. If a spill occurs wipe it up immediately.

2. Oven Cleaning: Oven spills should be cleaned straight away. Leaving them will cause burning and smoking inside the oven the next time it is used. Leaving spills can also cause permanent damage to the enamel and make it extremely hard to remove later. A non-caustic cleaner should be used such as non caustic "Mr. Muscle" to clean the chamber of the oven. Don not use caustic cleaners. Do not use abrasive scourers, sponges or cleaning products. Wipe the oven out regularly while the oven is still warm using hot soapy water and a soft cloth. The removal of the side supports makes cleaning easier.

3. Cleaning of Oven Door - All models: The inner door glass is held in by a number of screws and brackets at the top of the door, they can be removed and the glass slid out to allow cleaning in between the sheets of glass. With the glass removed the tension in the hinges will cause the door to slam closed so be sure to hold the door handle. The glass can be soaked in hot soapy water or special glass cleaners. The outer glass should be cleaned with a specific glass and mirror cleaner. Soapy water will remove stains and may leave streaks.

4. Removal of Side Shelf Supports - All models: The side racks are removed by simply flexing the bottom rail off the support and unhooking at the top. To replace just reverse the procedure.

5. Grill Element/Top Element - All models: This element must never be sprayed with any detergents. A damp cloth and a bottlebrush can be used to clean the roof of the oven and the element itself. Never soak the element and always dry it after cleaning as not doing so can lead to deterioration. It is important to clean this area regularly as fats spit up and stick to the ceiling and element while grilling and they may burn, smoke and give out unpleasant odours.

## CARE OF CATALYTIC LINERS

Some models may have catalytic liners installed within the oven cavity. They are the matte finished light coloured panels on the sides and the matte finished panel at the rear of the oven.

They work by collecting the grease and oil residues that occur during cooking. The liner self cleans by absorbing fats and oils and burning them to ash which is then easily removed from the floor of the oven with a damp cloth. The liner may discolour with age and should a large amount of fat be spilled onto the liner it may affect its efficiency. To overcome this problem set the oven to maximum temperature for about 10 - 20 minutes. Catalytic liners are designed for a working life of about 300 hours.

When the oven is cool wipe out the floor of the oven. Manual cleaning of the catalytic liners is not recommended. Damage will occur if soap impregnated steel wool pad or any other abrasives are used. We also do not recommend the use of aerosol cleaners on the liners.

If the walls of a catalytic liner are no longer effective you can remove the surplus grease with a soft cloth or sponge soaked in hot water then go through the cleaning cycle as described above. The lining must be porous to be effective.

## REPLACEMENT OF INTERNAL OVEN LIGHT

**WARNING:** Ensure the oven is switched off before replacing the lamp to avoid the possibility of electric shock.

Remove the glass protection cover unscrewing it in an anti-clockwise direction, replace the bulb with a similar bulb (15W) and reassemble.

Only use oven bulbs (T300°C) 15w.

Never touch the bulb directly; use protective gloves.

Only use bulbs available from authorised service centres.

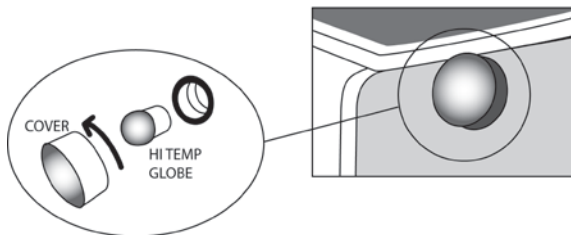

## REMOVING THE DOOR

Open the door fully and flip over the locking tabs. Close the door gently until it stops on the hinge mechanism. Hold the two sides of the door placing your hands near the hinges. Lift the door upwards, forming an angle of about 45% and carefully lift it away from the oven.

To reassemble the door insert the hinges making sure they locate in the groove at the bottom of the hinge. Allow the door to open fully making sure it stays in the grooves. Flip the locking tabs back over and close the door. If the door is out of alignment repeat the process.

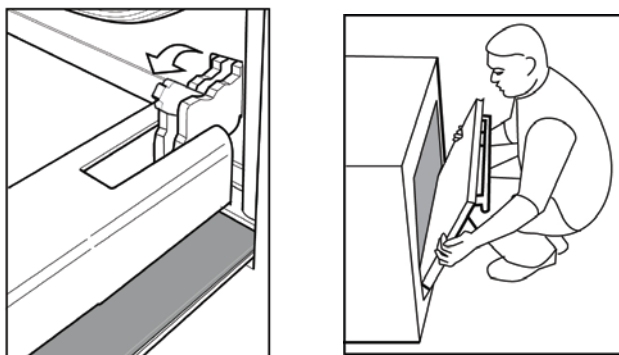

## OVEN INSTALLATION INSTRUCTIONS –

Qualified and licenced technicians only.

### POSITIONING THE OVEN

The oven is designed to be built-in to a fixture. The dimensions must be according to the measurements indicated in Figures 1, 2 and 3. The top/rear parts of the fixture must have an aperture of at least 80-90mm in depth as shown in Figure 1.

Screw in the 4 screws, first inserting them into the bushing and then inside the frame (Figure 1 A/B).

For installation under a work top, ensure that the rear/bottom part of the fixture has an aperture as shown in Figure 1. (reference C)

Do not use the door as a lever to insert the oven into the fixture.

Do not exert excessive pressure on the open door.

When installing the oven ensure that the supply cable does not kink.

Where the appliance is built into a cabinet, the cabinet must be capable of withstanding 70°C. Installation into low temperature tolerant cabinetry (e.g. Vinyl coated) may result in deterioration of the low temperature coating by discolouring or bubbling. If the appliance is to be installed adjacent to vinyl wrapped surfaces, use an installation kit available from the vinyl-wrap supplier. Glem Gas does not accept responsibility for damage caused by installation into low temperature tolerant cabinets.

After installation, test and ensure that the appliance operates correctly before handing it over to the customer.

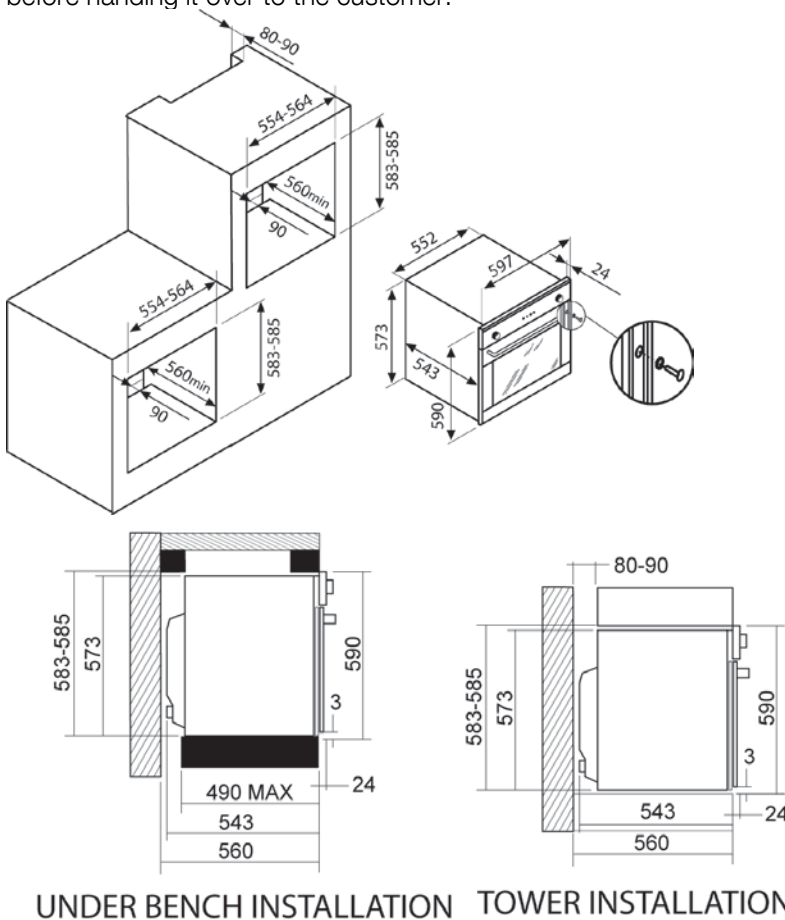

UNDER BENCH INSTALLATION    TOWER INSTALLATION

## LOCATION OF INSTALLATION

The oven must be installed and operated in a suitable place and in conformity with the laws in force.

### Air flow requirement

The installer must refer to the laws in force with regard to ventilation and discharge of combustion products.

The place where the gas oven is installed must have a natural air flow necessary for gas combustion. The room air flow required for combustion on Emilia and Glem gas ovens is 5 cubic meters/hour.

### Discharge of combustion products

The gas cooking ovens must discharge combustion products through extractor hoods connected directly to a flue or directly to the exterior as shown in the figure below. In the event that it is not possible to install an extractor hood, an electric fan must be installed to an external wall or window of the room.

Components illustrated in the figure:

A: Air inlet opening

C: Extraction hood for discharge of combustion products

E: Electric ventilator for discharge of combustion products

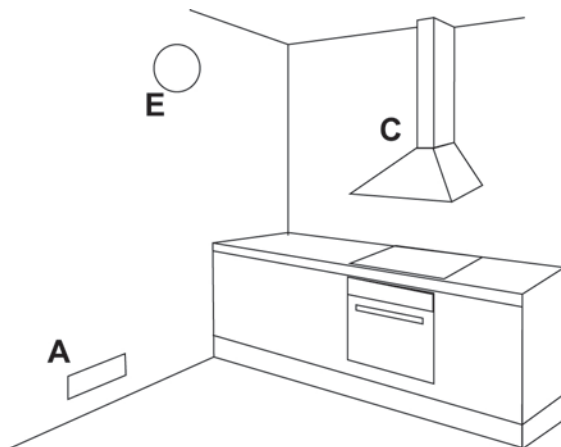

## INSTALLATION - ELECTRICAL CONNECTION

This installation must be undertaken by a licensed and authorised technician.

- The electrical supply for the oven must be a 240 Volt 50 Hz.
- The fuse and electrical wiring of the dwelling must support the load of the oven.
- The oven must be earthed. Connect the oven to a properly earthed and rated power socket, as appropriate.
- The flexible cord of the oven must not be subject to direct heat and must be positioned after installation so that its temperature does not exceed 75°C.

IMPORTANT: If a power socket needs to be installed or relocated, the work must be done by a licensed electrician.

IMPORTANT: For models supplied without a plug a means for disconnection shall be incorporated in the fixed wiring according to the wiring rules of the local electrical authorities.

In New Zealand the oven must be connected to the supply by a supply cord fitted with an appropriately rated plug that is compatible with the socket-outlet fitted to the final sub-circuit in the fixed wiring that is intended to supply the oven.

After installation, perform a brief test of the oven following the instructions in this manual. In the event that the oven does not function, disconnect it from the electricity supply and contact your nearest technical service centre.

The oven is powered by a cable:

- yellow – green = earth
- blue = neutral
- brown = phase

The manufacturer does not accept any responsibility for damages to persons or objects caused by a failure to observe the above prescriptions or due to tampering with even one single part of the device or the use of non-original spare parts.

## GAS OVEN INSTALLATION - Gas Connection

### WARNING!

THIS OVEN MUST BE INSTALLED BY AN AUTHORISED PERSON – PROOF IS REQUIRED FOR WARRANTY SERVICE CLAIMS.

The oven has been manufactured with a Natural Gas injector fitted. For use with LPG the oven must be converted by an authorised technician. The warranty will be voided if the LPG conversion is not undertaken by a qualified gas fitter. The conversion kit is supplied. Information on converting the oven is included with these instructions.

The requirements of the local gas and electrical authorities must be adhered to, consult AS5601 as appropriate. Gas inlet fitting is 1/2" BSP (male) thread. This oven can be connected with rigid pipe as specified in AS5601 table 3.1.

This oven is approved for hose connection in compliance with AS5601, clause 5.12.1.8. The flexible hose must comply with AS/NZS 1869 (AGA Approved), 10mm ID, class B or D, between 1 – 1.2 m long and in accordance with AS5601 for a high level connection. The hose should not be subjected to abrasion, kinking or permanent deformation and should be able to be inspected along its entire length. Unions' compatible with the hose fittings must be used and all connections tested for gas leaks. **THE HOSE MUST NOT BE EXPOSED TO TEMPERATURES EXCEEDING THAT FOR WHICH IT IS CERTIFIED.**

If the connection is for natural gas the test point pressure should be adjusted to 1.00 kPa with the oven operating at maximum.

If installing for use with LPG ensure that an AGA approved gas regulator suitable for a supply pressure of 2.75 kPa is part of the tank supply and the test point pressure is adjusted to 2.75 kPa. There is a gas pressure test point supplied with the oven that must be installed with the inlet hose. It is recommended that an isolating valve and union be fitted, to enable simple disconnection for servicing. These are to be in an accessible location.

- Check connections are gas tight with soapy water or other approved method.
- Under no circumstances use a naked flame in checking for leaks.
- Check Gas Adjustments (refer installation – gas checks and adjustments).

- When satisfied that the oven is operating correctly, instruct the customer in its safe operation.
- Ensure the customer understands fully by having them operate the oven in all its functions.

### **GAS CHECKS AND ADJUSTMENTS - LOW FLAME SETTING**

Check the low flame setting for the oven burner with the control engaged in the minimum position.

Light the oven burner and operate at maximum for 15 minutes. Turn the control until it engages in the minimum position and remove the control knob. Insert a screwdriver in the adjusting screw (located to the side of the gascock shaft or in the centre of the shaft).

To increase the flame, turn the adjusting screw anticlockwise. To decrease the flame, turn the adjusting screw clockwise. Adjust for a minimum, stable and clear flame. Ensure the minimum flame will not be extinguished when the oven door is closed.

### **FINAL CHECK**

Operate the oven burner on high and low flames and check that the burner ignites properly and has a stable flame. The following may be considered to be abnormal:

- If the burner has yellow tipping.
- If the burner is extinguished by opening and closing the oven door.
- If the burner fails to ignite properly.
- If the burner fails to remain alight.
- If the electrode constantly clicks when the burner is alight.

When satisfied with the operation of the oven, please explain to the user the correct method of operation. If the oven fails to operate correctly, contact your local service agent.

### Gas checks and adjustments - igniter operation

Check that the igniter successfully ignites the gas and that the burner remains alight. If an igniter fails to work or the burner fails to remain alight, first remove the plug from the electrical power outlet, and then check that all the electrical connections are in place. If the oven fails to operate correctly, call Glem Gas Australasia Pty Ltd or their appointed agent for service. Do not attempt repairs yourself.

### Gas checks and adjustments - pressure adjustment

First shut off the gas to the oven. Remove the sealing screw from the regulator test point at the rear of the oven and attach the hose from the manometer to the point. Turn the gas back on and light the burner on the maximum temperature setting. Check the pressure and adjust at the regulator if necessary to reach the settings in the table or on the data plate. For LPG adjust at the regulator at the cylinder.

Turn regulator adjusting screw clockwise to increase pressure and anti clockwise to reduce pressure. Refit the test point sealing screw when finished.

### Gas Conversion

If the oven is to be used with another gas type, either Propane Gas or Natural Gas, it must be converted by an Authorised Person. The table in this manual shows the appropriate injector sizes for either Propane Gas or Natural Gas.

### IMPORTANT NOTES

*THE INSTALLATION IS THE RESPONSIBILITY OF THE PURCHASER AND ANY INTERVENTIONS REQUESTED FROM THE MANUFACTURER DUE TO INCORRECT INSTALLATION ARE NOT COVERED BY THE WARRANTY.*

*Upon completion of the installation, the qualified technician MUST ISSUE A DECLARATION OF CONFORMITY OF THE WORK PERFORMED.*

*The above mentioned technician is responsible for any damage to persons or objects caused by connections which do not conform to regulations.*

1. *The oven must not be lifted using the door handle.*
2. *The oven must be serviced and checked every 3 to 4 years depending on usage and condition.*

### TECHNICAL DATA - Injector specification

	<u>NATURAL</u>			<u>PROPANE</u>		
	Inj Diam	MJ/H	Gas Press	Inj Diam	MJ/H	Gas Press
Oven Burner	1.23	7.5	1.0	0.79	8.5	2.75

## CONVERSION TO ULPG

The gas oven has been configured to operate on natural gas only. To operate on ULPG the oven must be converted. The conversion kit is provided with your oven.

*This is a relatively simple task but must be undertaken by a licensed gas fitter.*

**No responsibility will be accepted by Glem Gas if this requirement is not met and it will void the warranty**

To Convert to ULPG Operation –

Disconnect the electricity and gas.

1. Remove all oven shelves and grill tray.
2. Remove the cover plate in the base of the oven.
3. Undo the burner mounting screw. There is one mounting screw at the front of the burner.
4. Move the burner assembly slightly forward and to the side to expose the injector. Be very careful not to damage the thermocouple or ignitor lead.
5. Using a 7mm socket remove the injector.
6. Using the same socket, screw in the supplied injector, after first checking the size against the data plate. *If there is any doubt please contact Glem Gas service on 02 9721 2755.*
7. Carefully reassemble the oven burner.
8. Switch on the oven and check the size of the flame. It should be a steady blue flame that is not too big to protrude beyond the burner plate. Run the oven for a period of time at 180C until it reaches temperature. This is to check that once the oven reaches temperature the flame remains alight when it reduces.
9. Adjust as required. (see below)
10. Reinstall the cover plate.
11. Reinstall the oven shelves and grill tray.
12. Change the gas specification on the data plate and affix the ULPG label to the rear of the oven exterior.

## ADJUSTMENT OF THE THERMOSTAT MINIMUM SETTING

*The operation is performed with the oven installed in the fixture and after qualified personnel has completed the electrical and gas connections.*

This measure is necessary whenever the type of gas is changed natural gas to ULPG so as to guarantee a minimum temperature close to 150°C.

Follow the procedures below:

- Open the oven door
- Remove the floorplate
- Turn on the oven at maximum temperature and light the burner.
- When ignition has taken place, close the door.
- Position the knob of the thermostat at a temperature of approx. 150°C.
- Remove knob "a".
- Insert a screwdriver in hole "b", parallel to the stem of the thermostat and adjust the by-pass until a reduced but stable flame is obtained. This operation must be carried out with the oven door closed.
- Use a slotted screwdriver on the by-pass screw.
- When using ULPG, the by-pass adjustment screw must be fully tightened.

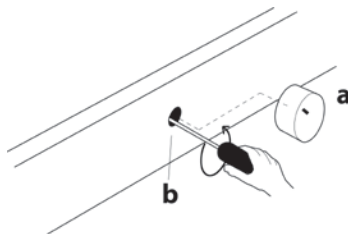

After having adjusted the burner, check that the flame remains at a minimum by following the procedures below:

- Turn the knob from the minimum to the maximum position 3 times.
- Open and close the oven door continuously 4/5 times, neither too quickly nor too slowly.
- If the flame goes out, adjust the by-pass once again (by slightly increasing the minimum setting).

Once these operations have been completed (injectors replaced, air and minimum setting adjusted), turn the oven off and up-date details on the label present on the oven door frame, indicating the new gas used.

## PRODUCT WARRANTY

Thank you for choosing a Glem Gas Appliance, the purchase of this appliance is an important investment in your home and so to protect your investment we urge you to complete the registration card attached, please return it immediately.

IT IS A WARRANTY REQUIREMENT THAT PROOF OF PURCHASE BE PROVIDED PRIOR TO REQUESTING A SERVICE CALL.

THIS WARRANTY SHALL NOT APPLY IF THE APPLIANCE WAS NOT INSTALLED BY A LICENSED TECHNICIAN AND PROOF IS NOT SUPPLIED.

The benefits conferred by this warranty are in addition to all other conditions and warranties in respect of this product which the consumer may have under the Trade Practices Act 1874 of the Commonwealth of Australia and/or similar State or Territory Laws.

Our goods come with guarantees that cannot be excluded under the Australian Consumer Law. You are entitled to a replacement or refund for a major failure and for compensation for any other reasonably foreseeable loss or damage. You are also entitled to have the goods repaired or replaced if the goods fail to be of acceptable quality and the failure does not amount to a major failure.

Glem Gas Australasia Pty Ltd warrants, this appliance to be free from defects in workmanship and materials for a period of:

- a) Where the appliance is intended to be used and is used for DOMESTIC USE – 24 MONTHS FROM DATE OF DELIVERY TO THE ORIGINAL PURCHASER.
- b) Where the appliance is intended to be used and is used for COMMERCIAL USE – 90 DAYS FROM DATE OF DELIVERY TO THE ORIGINAL PURCHASER.

Glem Gas Australasia Pty Ltd, during the period of warranty, will at its option, and subject to the terms and conditions stated below, repair or replace free of charge this appliance or any component part, which upon examination by Glem Appliances P/L. is found to be defective.

## THIS WARRANTY SHALL NOT APPLY:

- a) If the rating plate has been removed or the serial number or other details on it have been removed or rendered illegible.
- b) If the appliance is connected to any gas type or voltage other than shown on rating plate.
- c) If the appliance has been subjected to misuse, abuse accident or want of care.
- d) If the appliance has been installed, operated or maintained contrary to the instructions supplied by Glem Gas Australasia Pty Ltd.
- e) If any defect or failure is due to connection to an inadequate or faulty gas or power supply.
- f) If damage is caused by foreign objects in or on the appliance or by reason of its use for purposes other than that for which it was delivered.
- g) If a repair has been made or attempted by the purchaser.
- h) Where the oven is installed outside an 80km radius from the GPO of any Australian Capital City to freight and travel costs beyond that radius.

This warranty does not cover any glass damage or replacement of light bulbs.

Parts covered under warranty that need replacing i.e.: seals, knobs and burner caps. These can be posted to customer to put on at their discretion.

This Warranty is given by Glem Gas Australasia Pty Ltd and no other person or organisation is authorised to vary its provisions and conditions.

**Complete this section and keep it for your own record.**

Appliance type  Model No.  Serial no.

Purchased from  Date of purchase

## WARRANTY FORM

**Please complete the section below and return to:**

Glem Gas Australasia Pty. Ltd, PO Box 63 Blaxcell PO South Granville or fax to 02 9721 2766

Appliance type  Model No.  Serial no.

Purchased from  Date of purchase

Customer Name  Address

Installers Name  Installers licence no.

Installers Signature

Installers Compliance Number

## INSTALLERS CHECK LIST

You must test the oven after installation before you hand it over to the customer. On gas ovens you must have a manometer and a connecting tube to check that the gas pressure is correct.

The following checks must be made to commission the oven and to activate the warranty. If this form is not completed fully and correctly it will void the warranty.

### INSTALLATION CHECK

#### GAS OVENS

- |    |  |     |                          |    |                          |
|----|--|-----|--------------------------|----|--------------------------|
| 1. | Has a leak test been completed using soapy water?                  | YES | <input type="checkbox"/> | NO | <input type="checkbox"/> |
| 2. | Is the gas regulator set for the correct gas type and pressure?    | YES | <input type="checkbox"/> | NO | <input type="checkbox"/> |
| 3. | Is the jet correct for the type of gas being used?                 | YES | <input type="checkbox"/> | NO | <input type="checkbox"/> |
| 4. | Does the gas burner light and stay lit after reaching temperature? | YES | <input type="checkbox"/> | NO | <input type="checkbox"/> |
| 5. | Is the flame blue and appropriately sized?                         | YES | <input type="checkbox"/> | NO | <input type="checkbox"/> |

#### ALL OVENS

- |    |   |     |                          |    |                          |
|----|---|-----|--------------------------|----|--------------------------|
| 1. | Have the supplied installation components been used?                | YES | <input type="checkbox"/> | NO | <input type="checkbox"/> |
| 2. | Is the oven earthed and wiring polarity correct?                    | YES | <input type="checkbox"/> | NO | <input type="checkbox"/> |
| 3. | Has the power cable been checked so it is not touching the oven?    | YES | <input type="checkbox"/> | NO | <input type="checkbox"/> |
| 4. | Is the door closing correctly and the shelves correctly installed?  | YES | <input type="checkbox"/> | NO | <input type="checkbox"/> |
| 5. | Does the customer understand how to operate the oven?               | YES | <input type="checkbox"/> | NO | <input type="checkbox"/> |
| 6. | Has the oven been operated and seen to be reaching temperature? YES | NO  | <input type="checkbox"/> |    | <input type="checkbox"/> |

Model Number

Date of Installation

Name of Installer

Licence number

Installers Signature:

Owner's Signature confirming the above:

GLEM GAS AUSTRALASIA PTY. LTD.

P.O. Box 63 Blaxcell PO South Granville NSW 2142

Phone: 02 9721 2755 – Fax: 02 9721 2766 – [www.glemgas.com.au](http://www.glemgas.com.au)

Email us [info@glemgas.com.au](mailto:info@glemgas.com.au)

Free call 1 300 307 917

