



OPERATING INSTRUCTIONS OF

REFRIGERATOR

MODEL: HBF130
HBF130S

- Please read this operation manual carefully before operation.
- Keep it properly for future reference.
- For Domestic Use Only

CONTENT

Name of Each Part	1
Adjusting	2
Setting up	3
Operation Instruction	4-6
Left/Right - opened door	7
Repairing	8
Main Technical Data	9

* The manufacturer keeps on developing various types of refrigerators, so he has the right to modify designs, products and technical data without further notice.

Name of each part

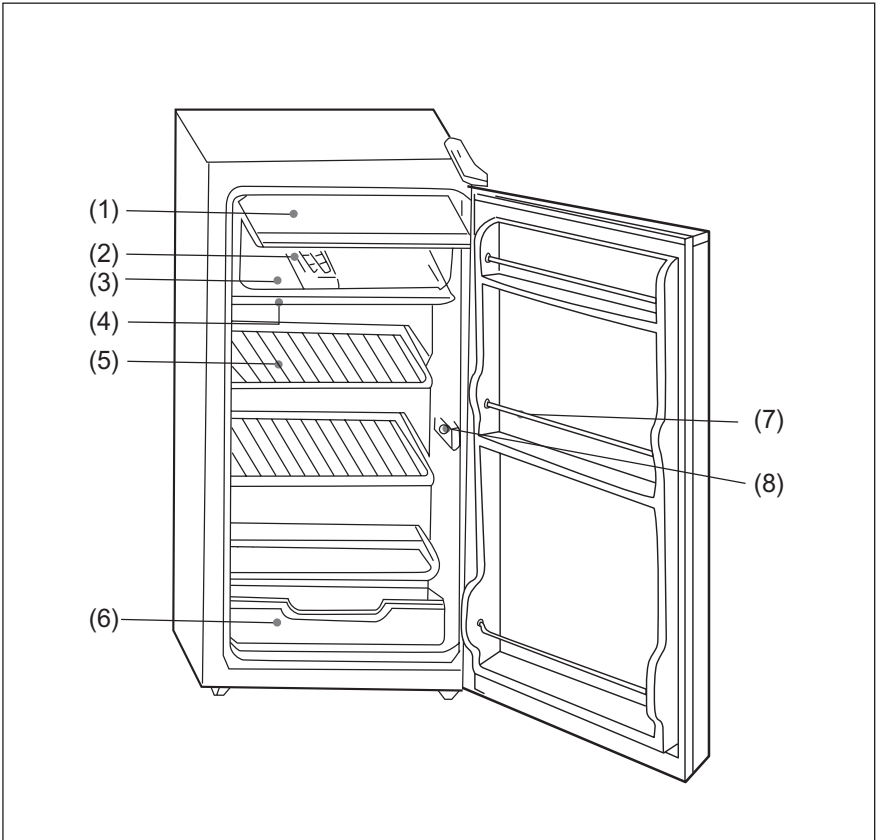

(1) Evaporator door

(2) Ice-tray

(3) Evaporator

(4) Drip tray

(5) Shelf

(6) Vegetable box

(7) Bottle rack

(8) Knob of thermostat

Adjusting

- If the floor is uneven please adjust the adjustable screws at the front of the refrigerator by using the spanner to level the refrigerator. (the spanner is included in the bag).

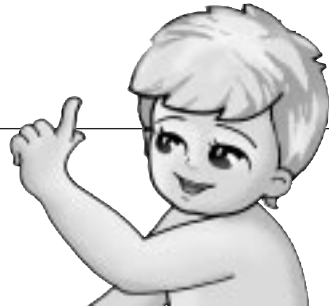
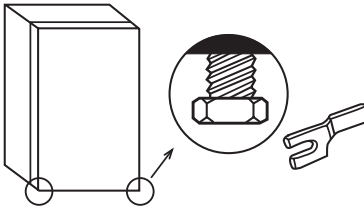

⚠ WARNING:

If the supply cord is damaged, it must be replaced by the manufacturer, or authorised service agent or similar qualified person in order to avoid a hazard.

The plug should be accessible after the appliance is positioned.

⚠ WARNING:

The appliance is not intended for use by young children or infirm persons without supervision.

⚠ WARNING:

Young children should be supervised to ensure that they do not play with the appliance.

Setting up

Setting up

- The appliance can't be placed with its rear panel directly against the wall. For good air circulation, the vent grille at the back of the worktop must not be blocked. It should be placed on flat and firm ground lest it gives off higher noise than usual.
- Poorly ventilated rooms are unsuitable. Avoid positioning the appliance in direct sunlight or exposing to similar sources of heat.
- Never store anything dangerous in the appliance, such as combustibles, explosives, strong acid and alkali, etc.
- The appliance is not intended for use by young children or infirm persons without supervision.
- Young children should be supervised to ensure that they do not play with the appliance.
- The power supply for appliance is 240V~, 50Hz single phase.
- It is not recommended to use extension cords.
- Connect the appliance with a properly earthed three-wire plug and socket.

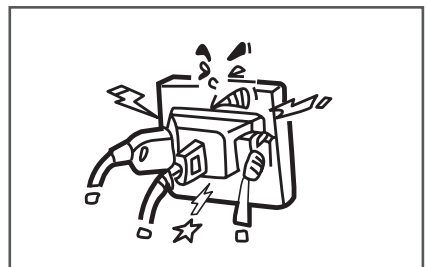
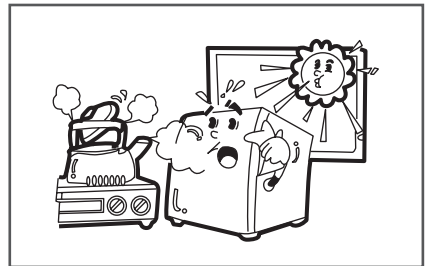
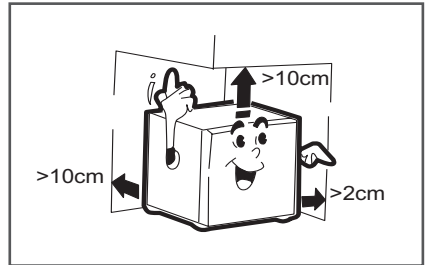

Thermostat

- The knob graduation 0, 1, 2, 3, 4, 5, 6, 7, does not stand for concrete temperature. The smaller the numbers, the higher the temperature in the compartment and vice versa. Usually, it's better to put the thermostat in Pos. "1", Pos. "4", Pos. "0" shows the power is cut off.

Storing food

- The temperature varies within the refrigerator are different due to different refrigeration distribution. Thus when you store food, select the best position to meet your needs.
- The coldest position is 1. Temperature from low to high in order as 2,3,4,5,6,7.

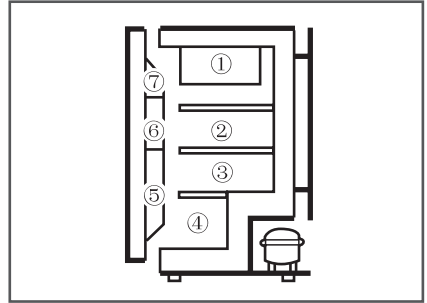

Ice-making

- When making ice, add water to the ice tray until 4/5 full with the grid in it and place it on the bottom of the ice chamber. Twist the tray or place it briefly in warm water to remove the ice cubes.
- NOTE
Do not use a knife and the like when removing the ice tray.

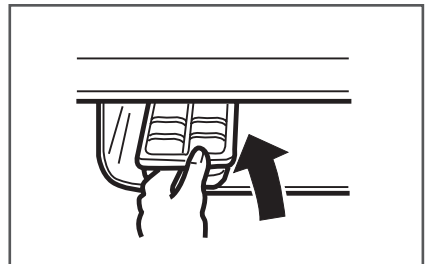

Operating Instructions

Notes on storage

- Where necessary, food should be packed in bags, to avoid giving off strong odours or getting wet or dry.

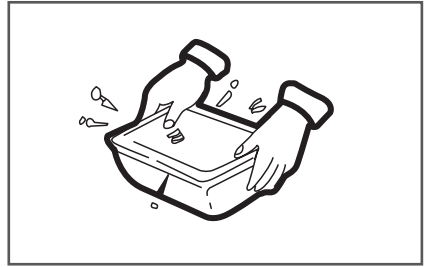

- Do not store food too full in the appliance. Allow space among the packages of food for perfect refrigerating.

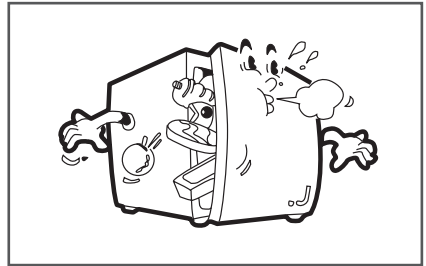

- Hot food or liquid must be cooled to room temperature before placing in refrigerator.

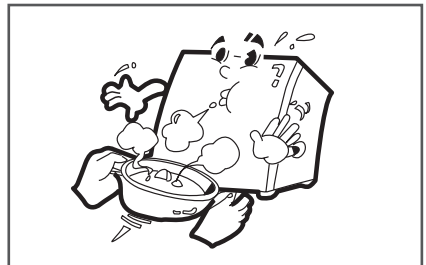

Cleaning

- The appliance can only be cleaned when the net-work plug is removed. Clean it with luke-warm water containing a little detergent. In any case do not use hot water, corrosive scouring agent or anything rough.

- NOTE
Do not use anything rough for cleaning.

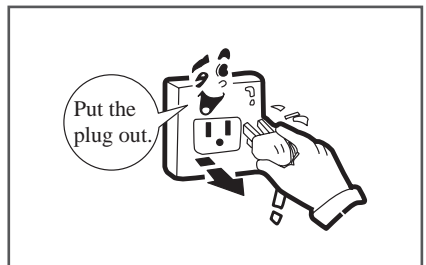

Operating Instructions

Defrosting

- When defrosting, switch off the appliance. Remove food from the ice chamber, it will be defrosted automatically. When the defrosting process has been completed, the drip-tray should be depleted. Replace the food and switch on the appliance.

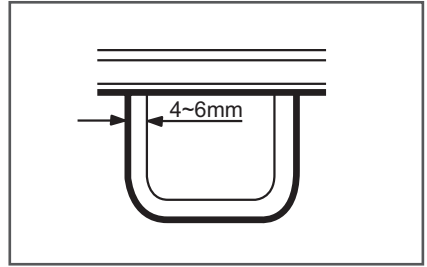

Note

- If the appliance remains out of use for some time, pull out the plug to disconnect the appliance from the power supply. Clean the interior as described above to prevent odours from forming inside.
- The appliance door should be opened as little and briefly as possible to reduce energy consumption.
- In the event of a power failure, try to keep the appliance closed to maintain the refrigeration as long as possible.

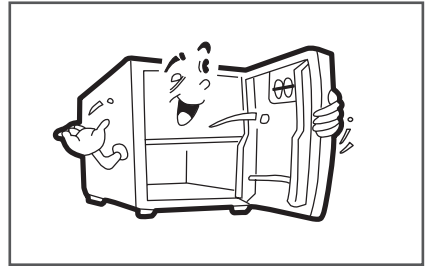

Left/Right-opened door

- This product is assembled according to the right-opened door configuration. The right hinge together with its mount is fixed on the right side of the door body. Take out the door handle from the accessory parts and fix it on the left side of the door body. The two holes on the right side of the door body shall be stuffed with the handle hole stoppers, as an item of accessory parts.

- In case the left-opened door configuration is required, this can be achieved by using accessory parts.
 - 1) Remove the right hinge, hinge mount and the lower hinge from the door body.
 - 2) Put stoppers in the holes that occur.
 - 3) Install the left hinge and hinge mount (two items of accessory parts) onto the corresponding location at the left upper corner of the refrigerator body with screws removed from the right hinge.
 - 4) Dismantle the shaft from the lower hinge, put it into the hole on the left side and fasten it securely.
 - 5) Install the door body with the refitted lower hinge and put the lower hinge adjusting pad in place.
 - 6) Install the door handle on the right side of the door body with screws through two holes and fasten them securely.
 - 7) Stuff the two holes on the left side of the door body with handle hole stoppers.

Repairing

- In the event of a fault occurring during operation, check first if the fault is due to an operation error. You can repair the following faults yourself.



<ul style="list-style-type: none">● The appliance does not run.	<ol style="list-style-type: none">1. It is not switched on properly, or the mains plug is not properly inserted in the socket.2. The thermostat knob is turned to position “0”.3. Supply voltage is too low.
<ul style="list-style-type: none">● The temperature inside the appliance is not low enough.	<ol style="list-style-type: none">1. The appliance is too full of food.2. The appliance is located too close to a source of heat.3. The door is not properly closed or is opened too frequently.4. The vent grille is covered over.
<ul style="list-style-type: none">● Excessive noise from the appliance.	<p>The appliance is not standing securely on the ground.</p>

If it is none of these circumstances and you are not able to repair the fault, please contact a authorised service agent.

Main technical data

MODEL	HBF130	HBF130S
CAPACITY	117L	117L
VOLT	240V~,50Hz	240V~,50Hz
WATT	125W	125W
REFRIGERANT	R134a 61g	R134a 61g
OVERALL DIMENSION (DxWxH)	550x500x865mm	550x500x865mm
ANTI-SHOCK SAFETY CLASSIFICATION	I	I

VC532007



0060506705