

# 155 GALLON DECK BOX

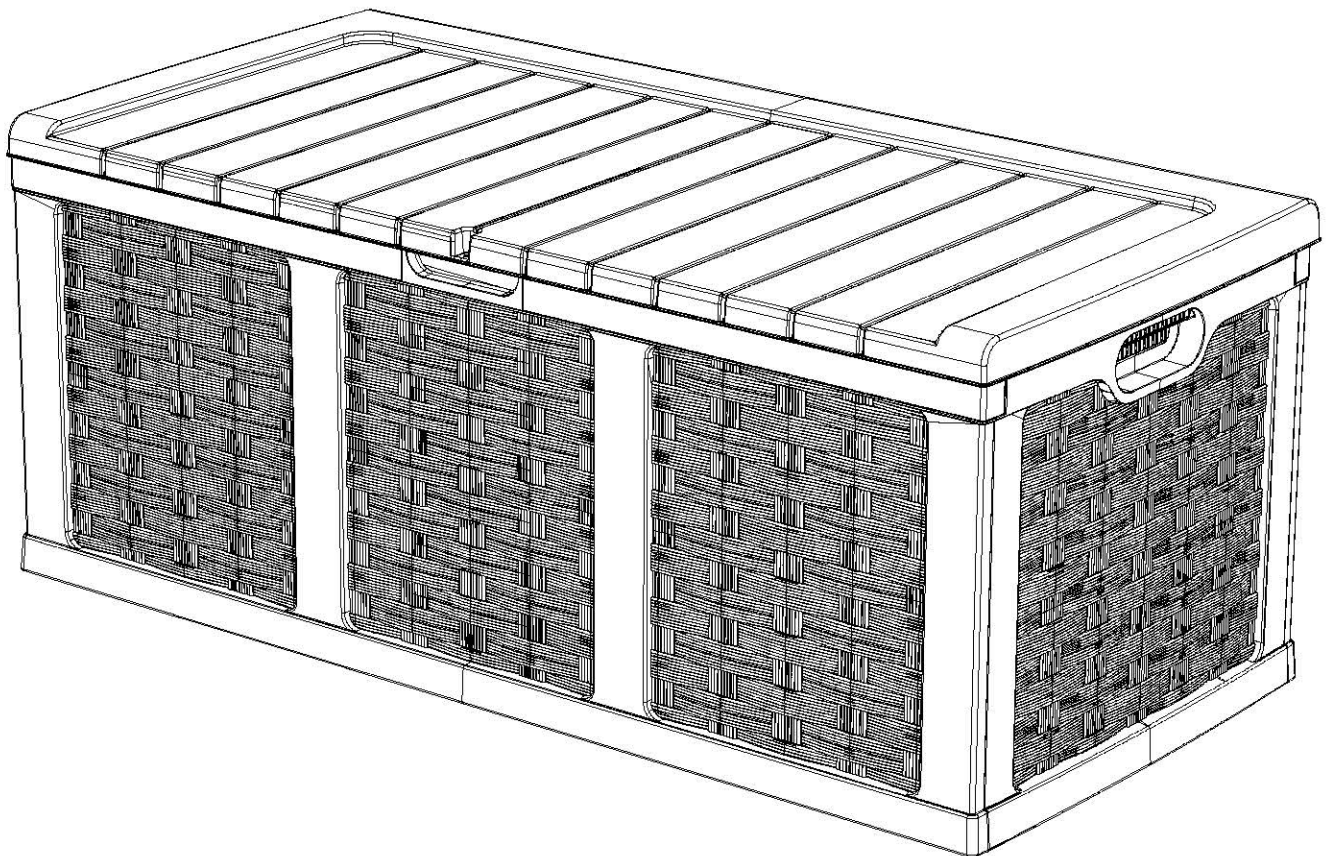

**272-0954**

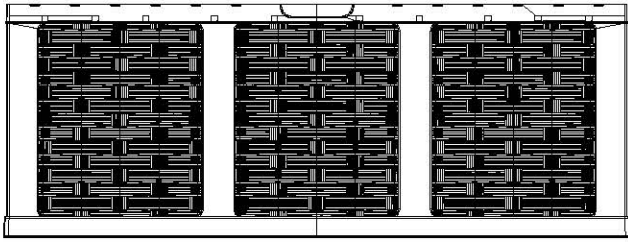

**A x2**

1-66-811 (front/rear wall)

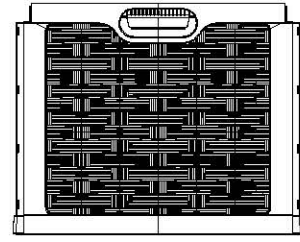

**B x2**

2-66-811 (side wall) + 7-66-811 (handle)



**C x1**

3-66-811 (bottom)

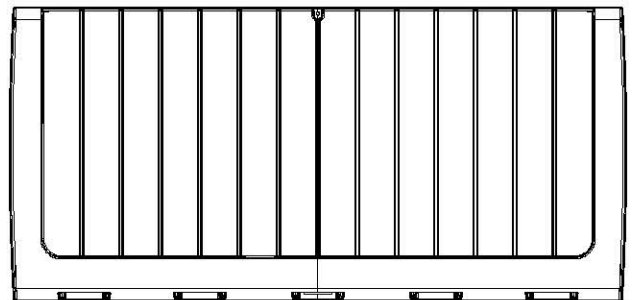

**D x1**

6-66-811 (cover)

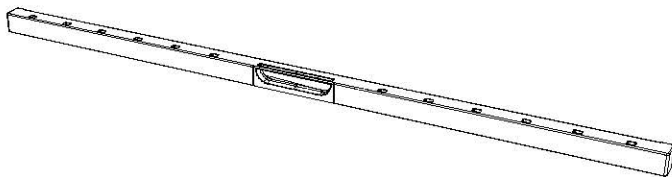

**F x1**

4-66-811 (front connector)

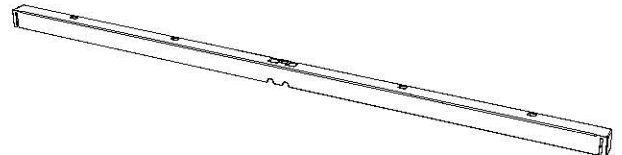

**E x1**

5-66-811 (rear connector)

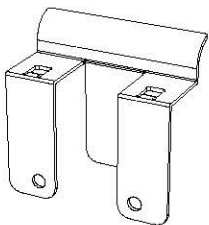

**G x1**

VPT066811 (axle)

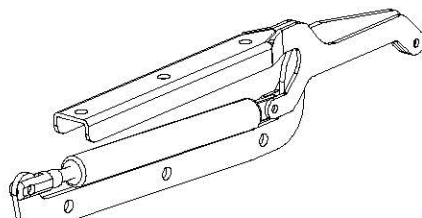

**H x2**

VPT066811 (piston)

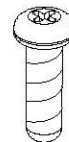

**I x14**

VPT066811 (screw)



**J x5**

8-66-811 (small cover)



spare parts not included

1

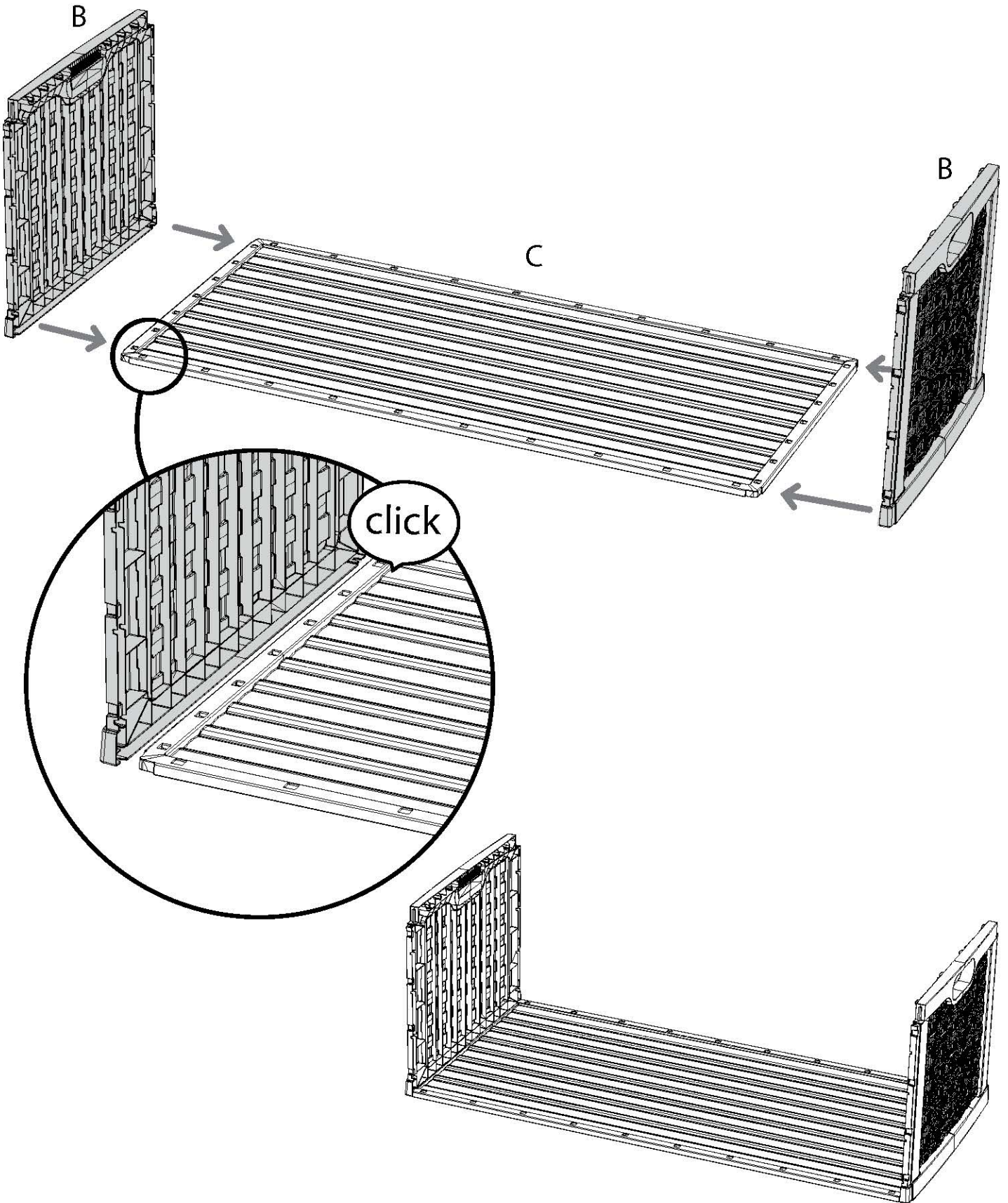

2

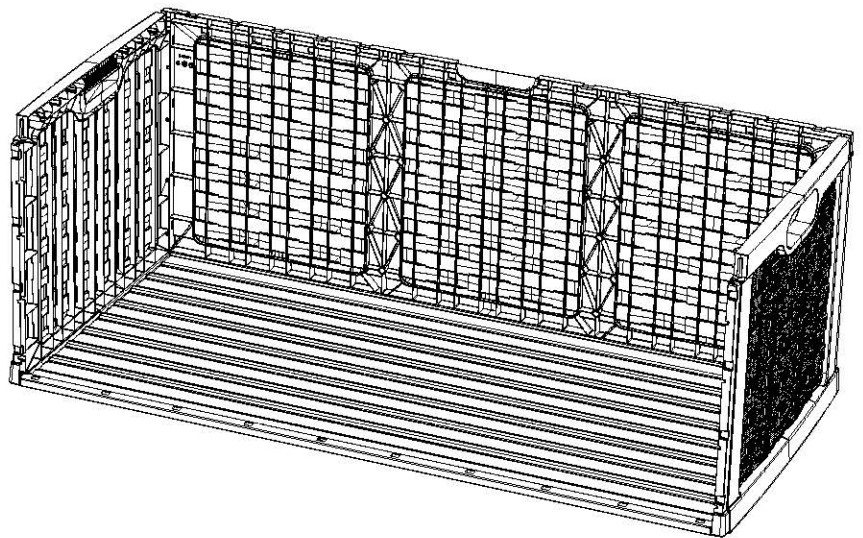
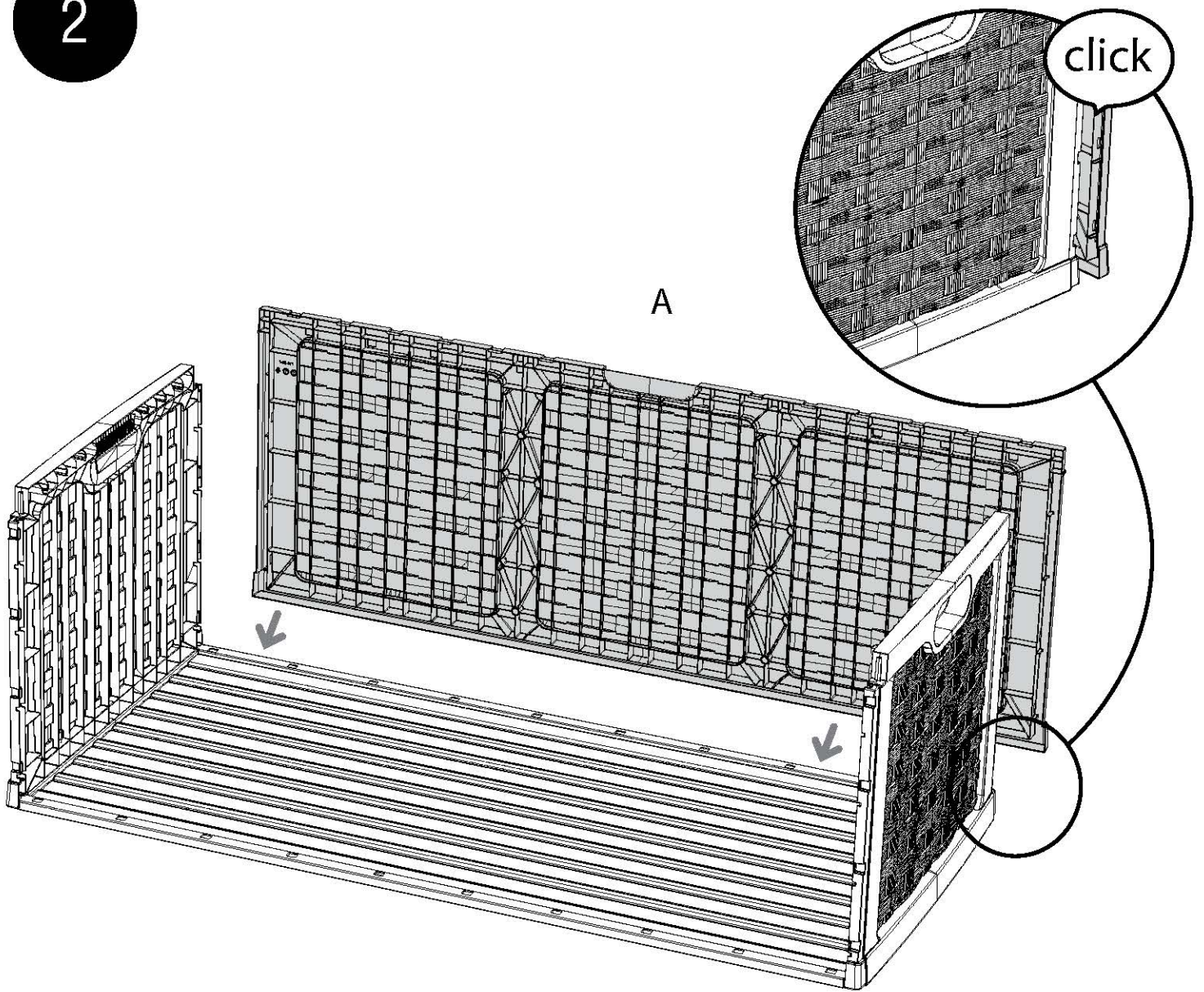

4

3

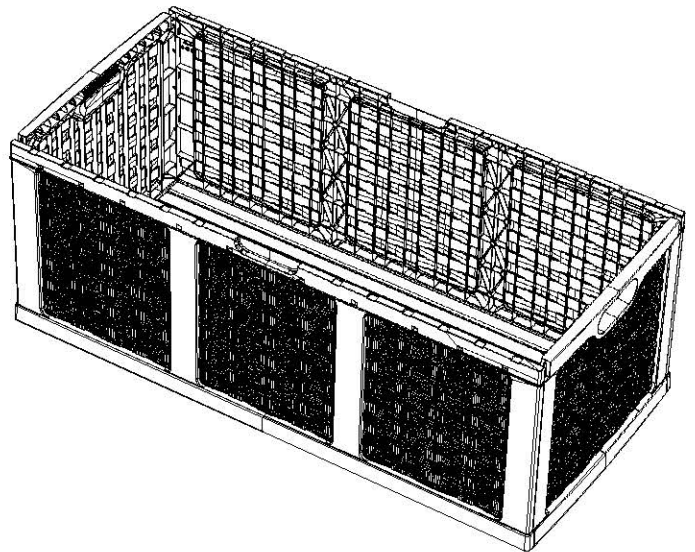
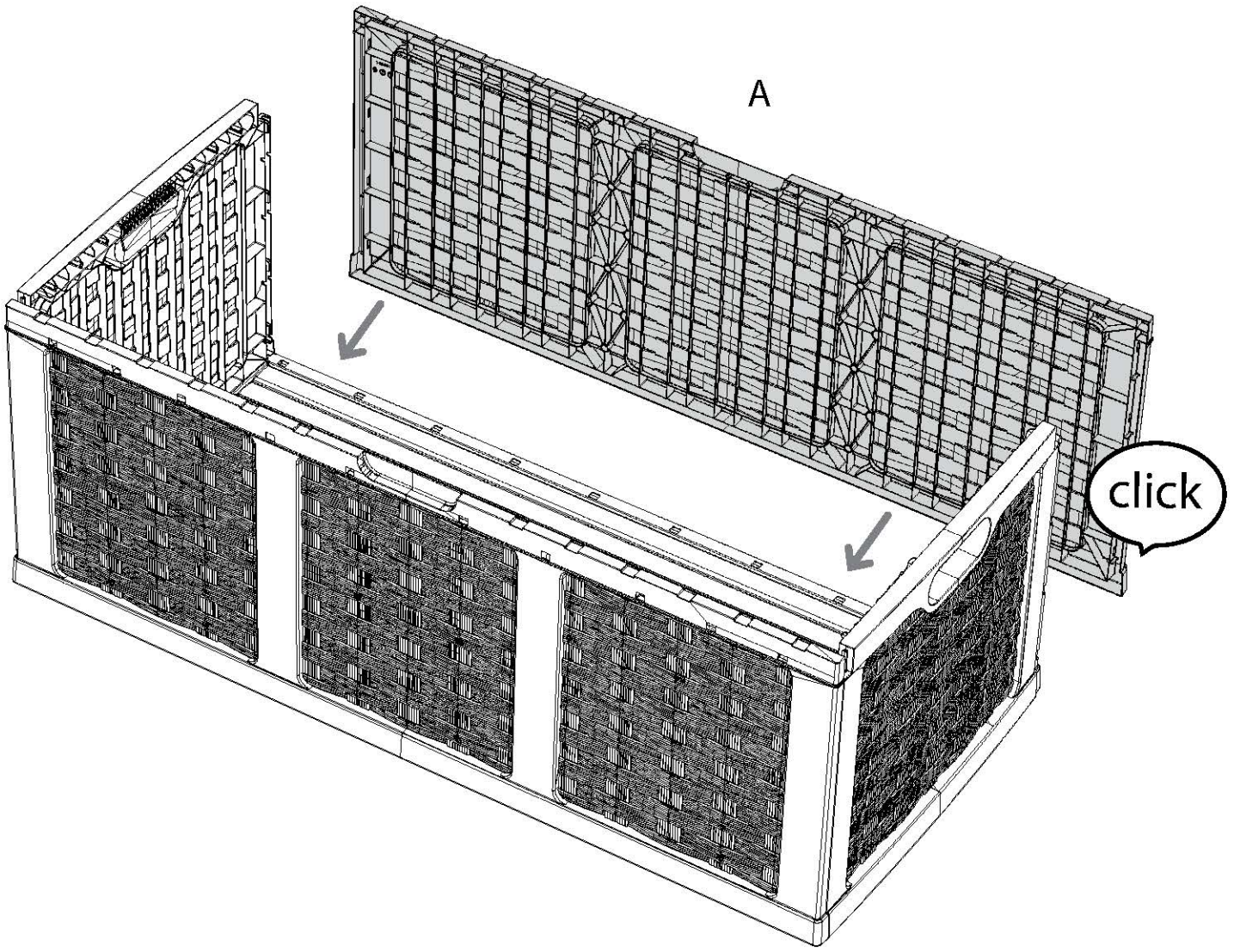

4

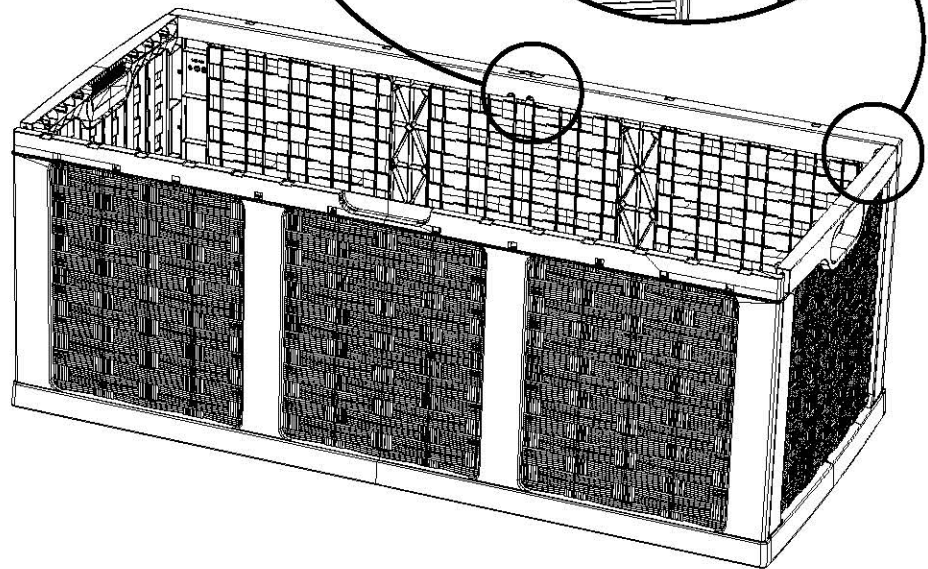
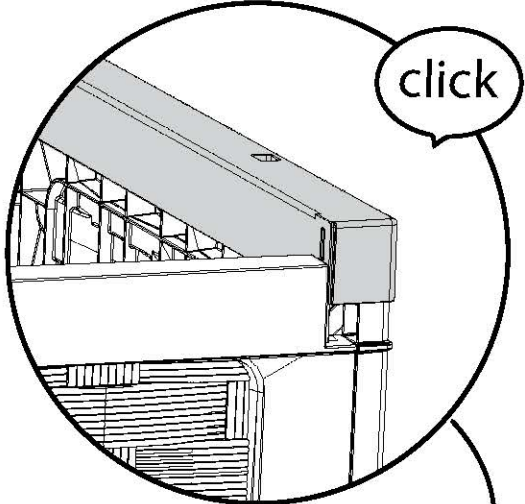
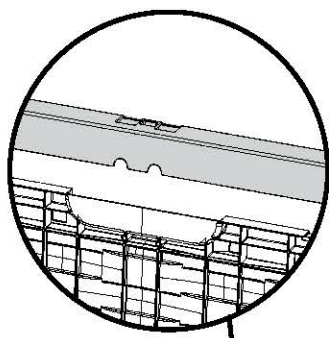
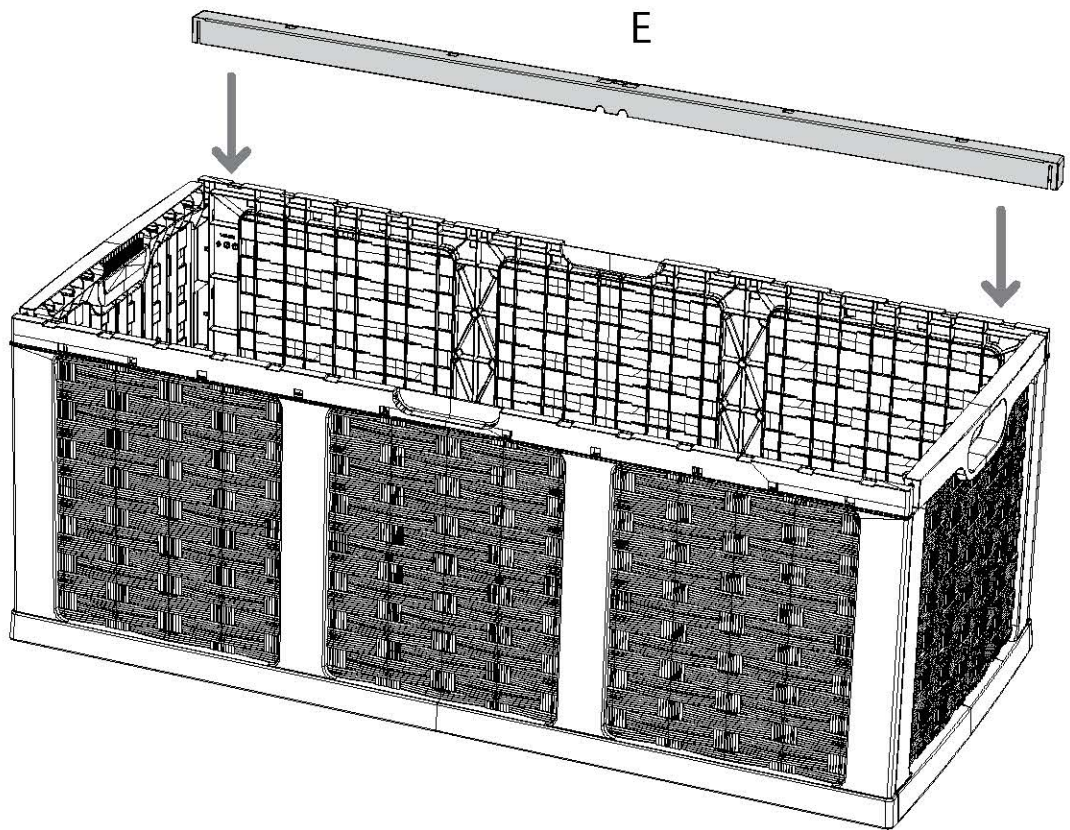

5

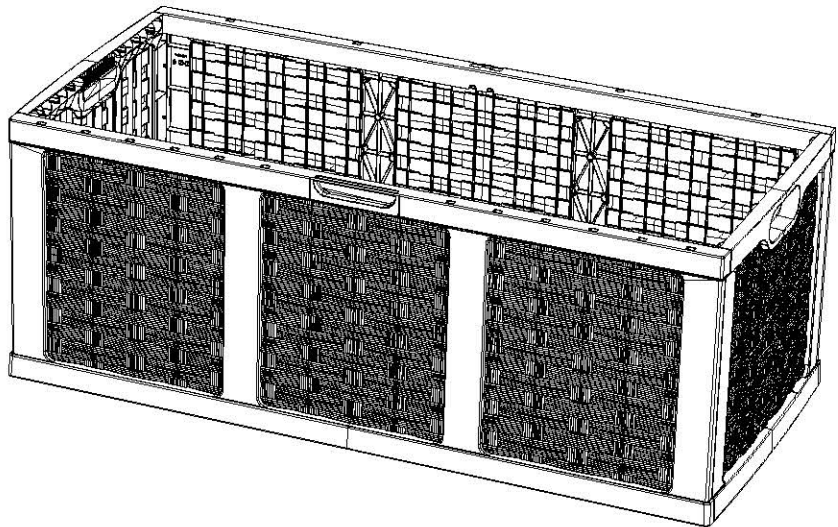
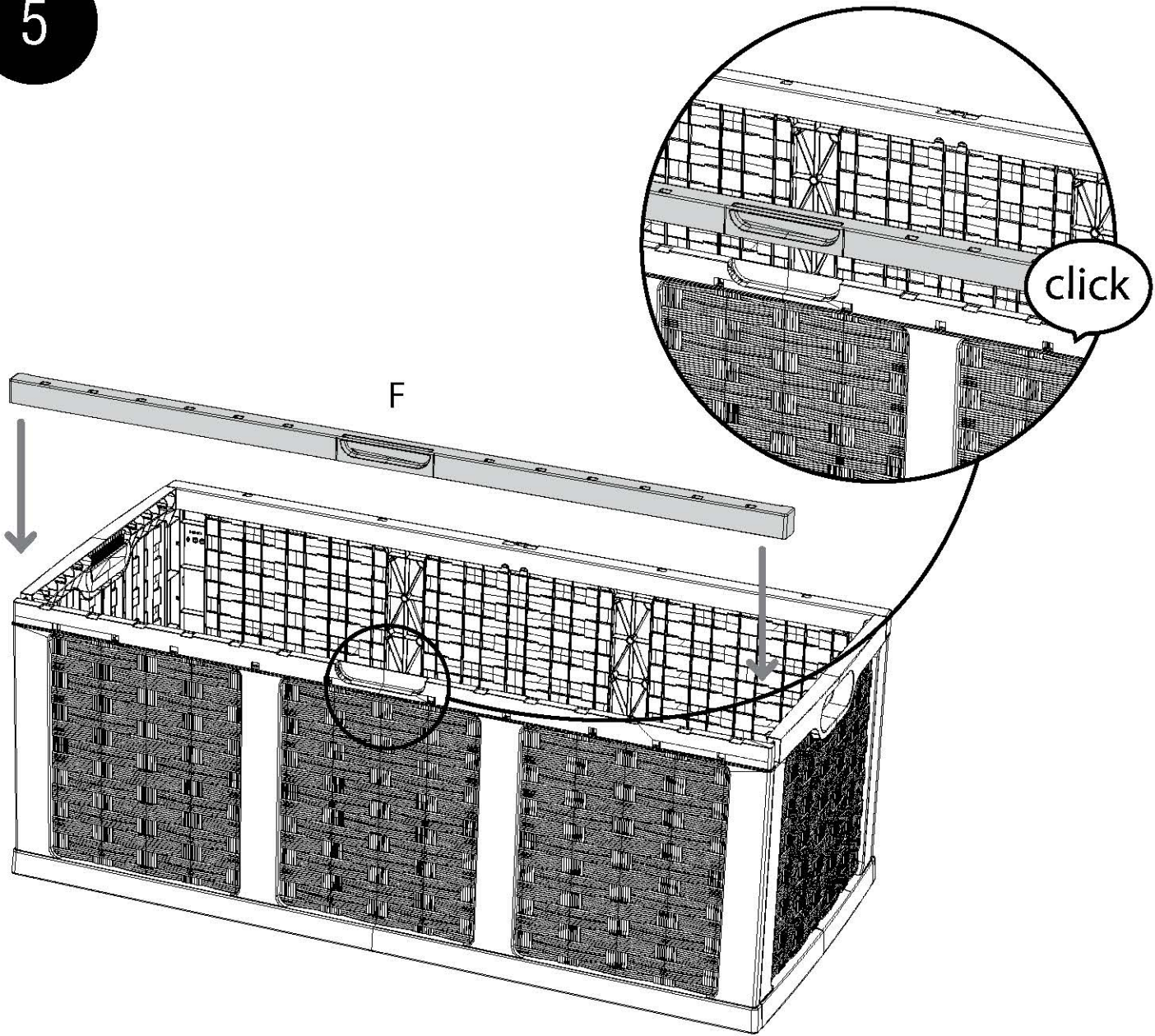

6

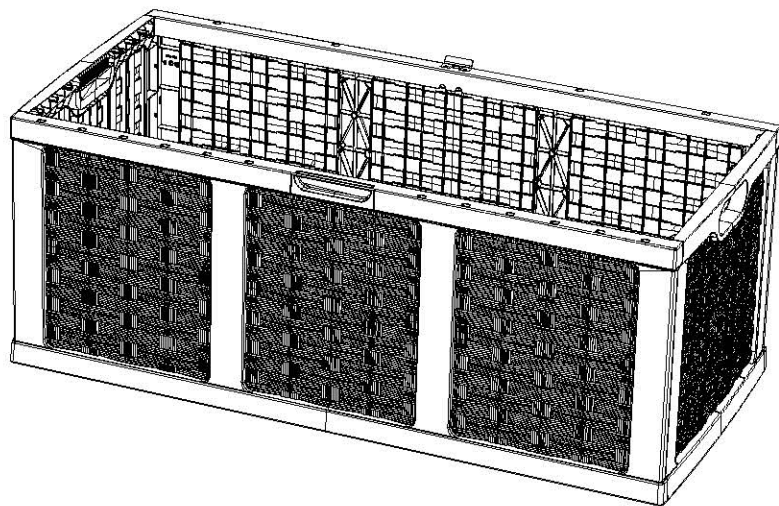
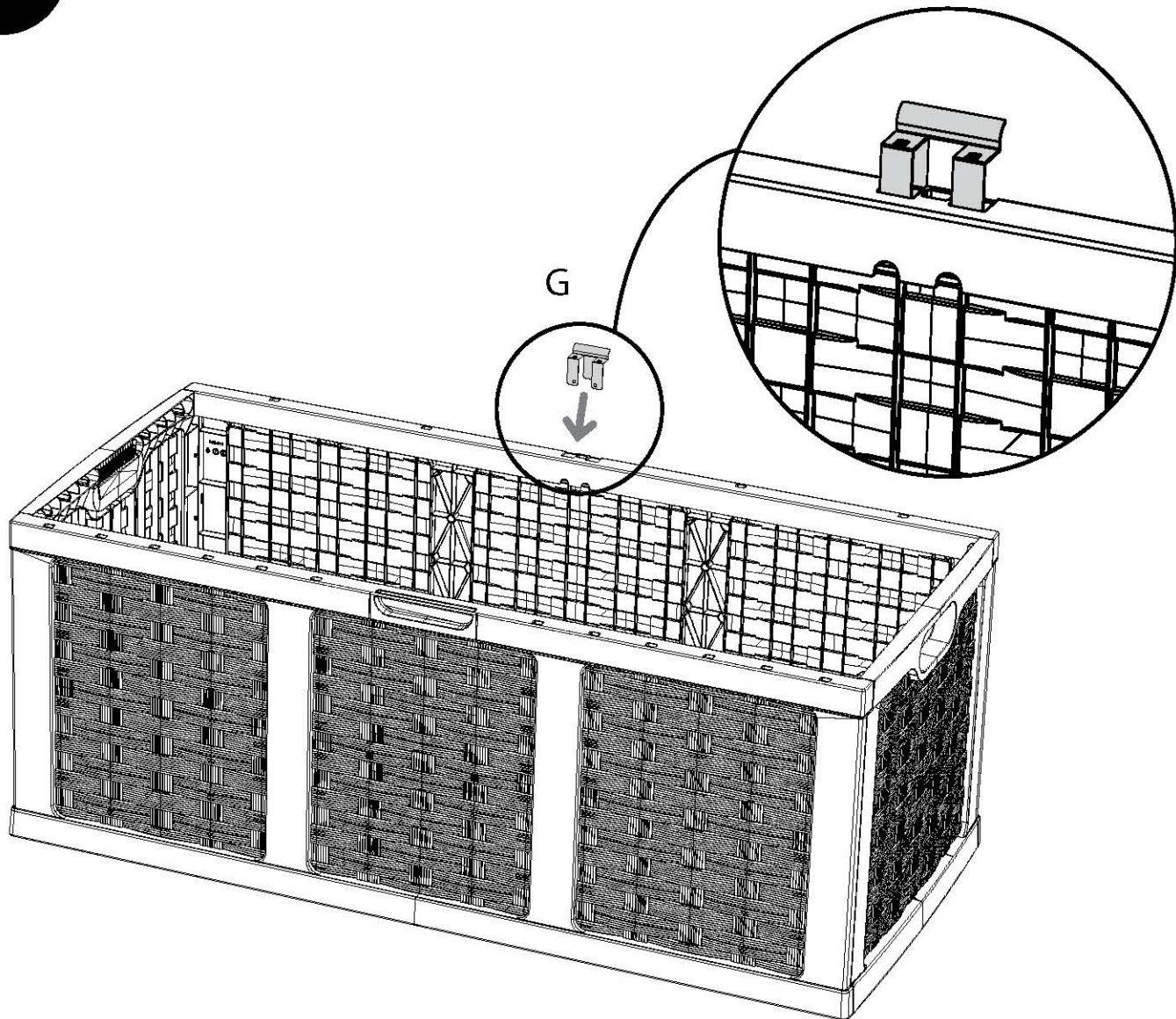

8

7

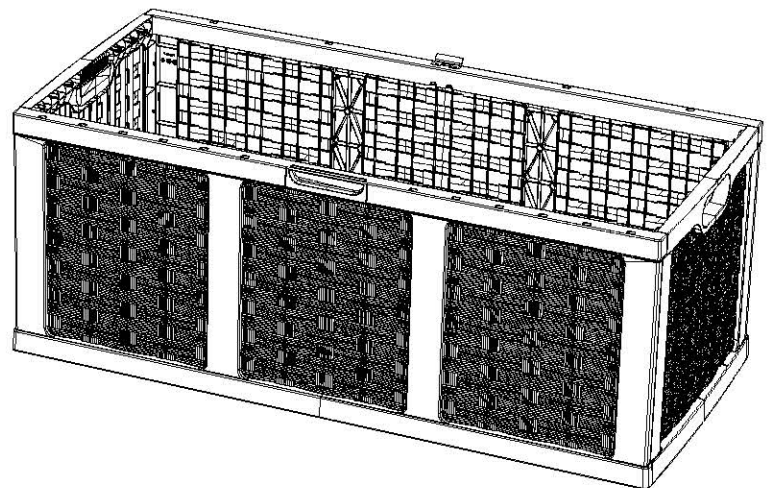
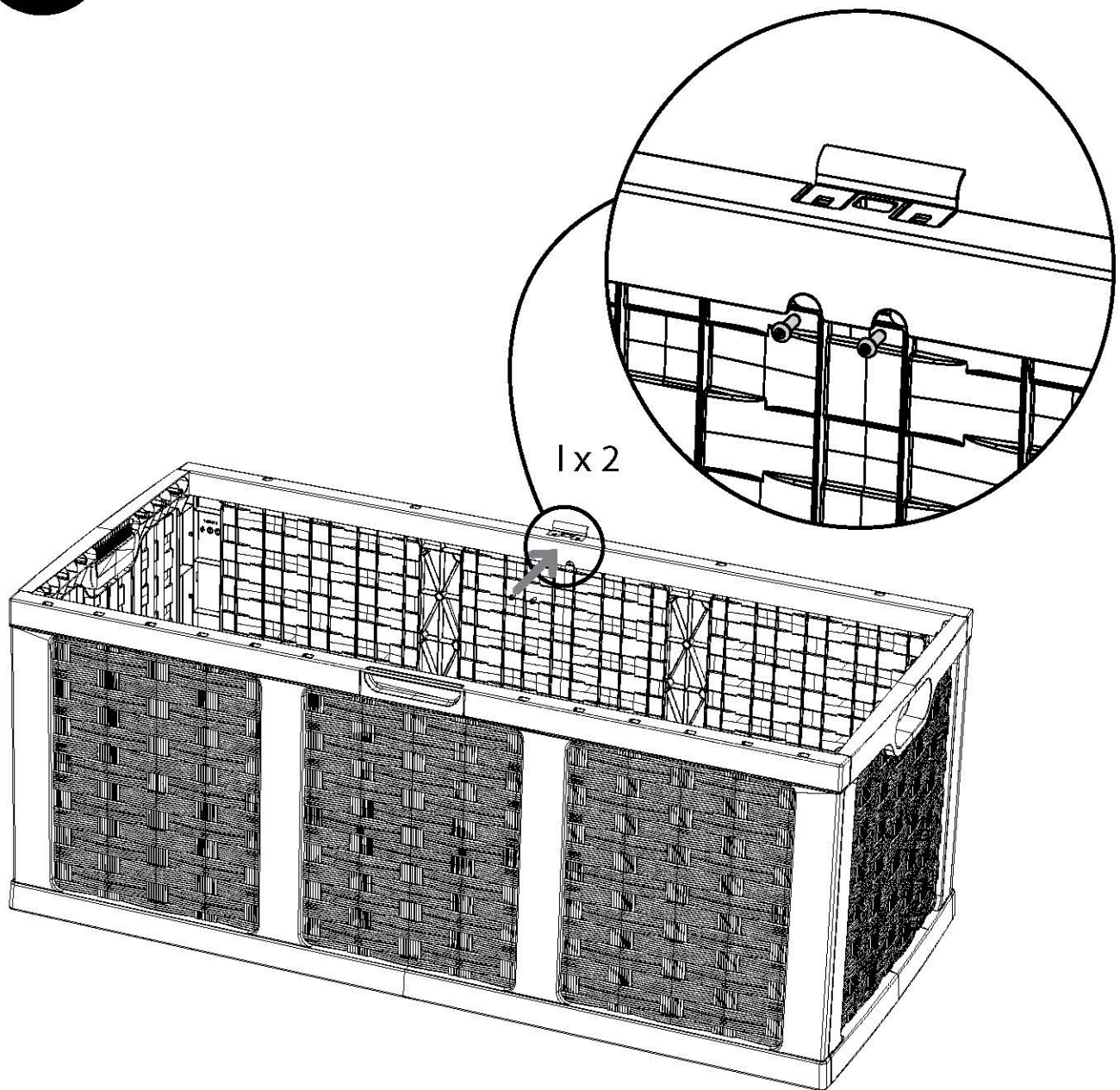

8

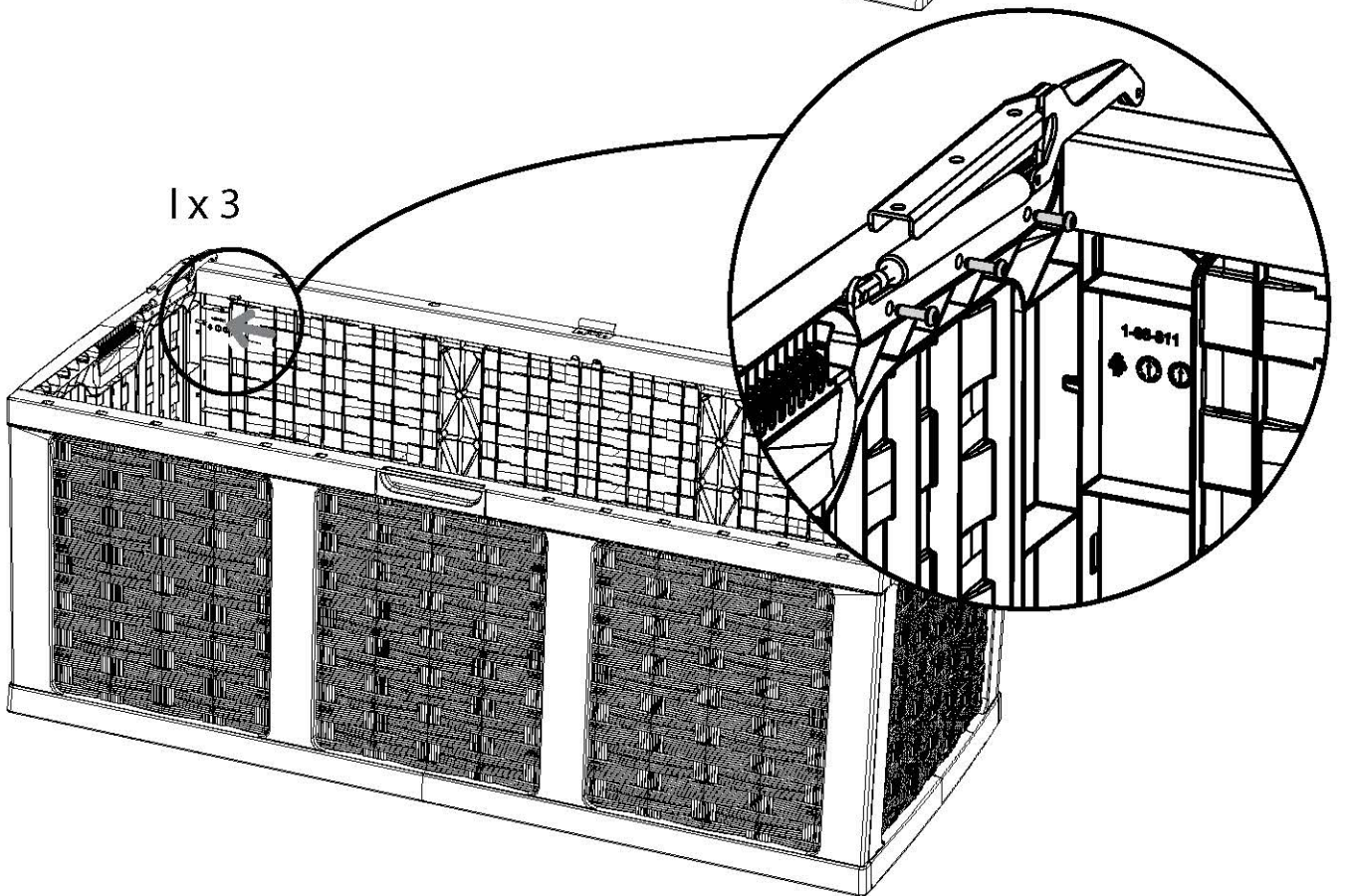
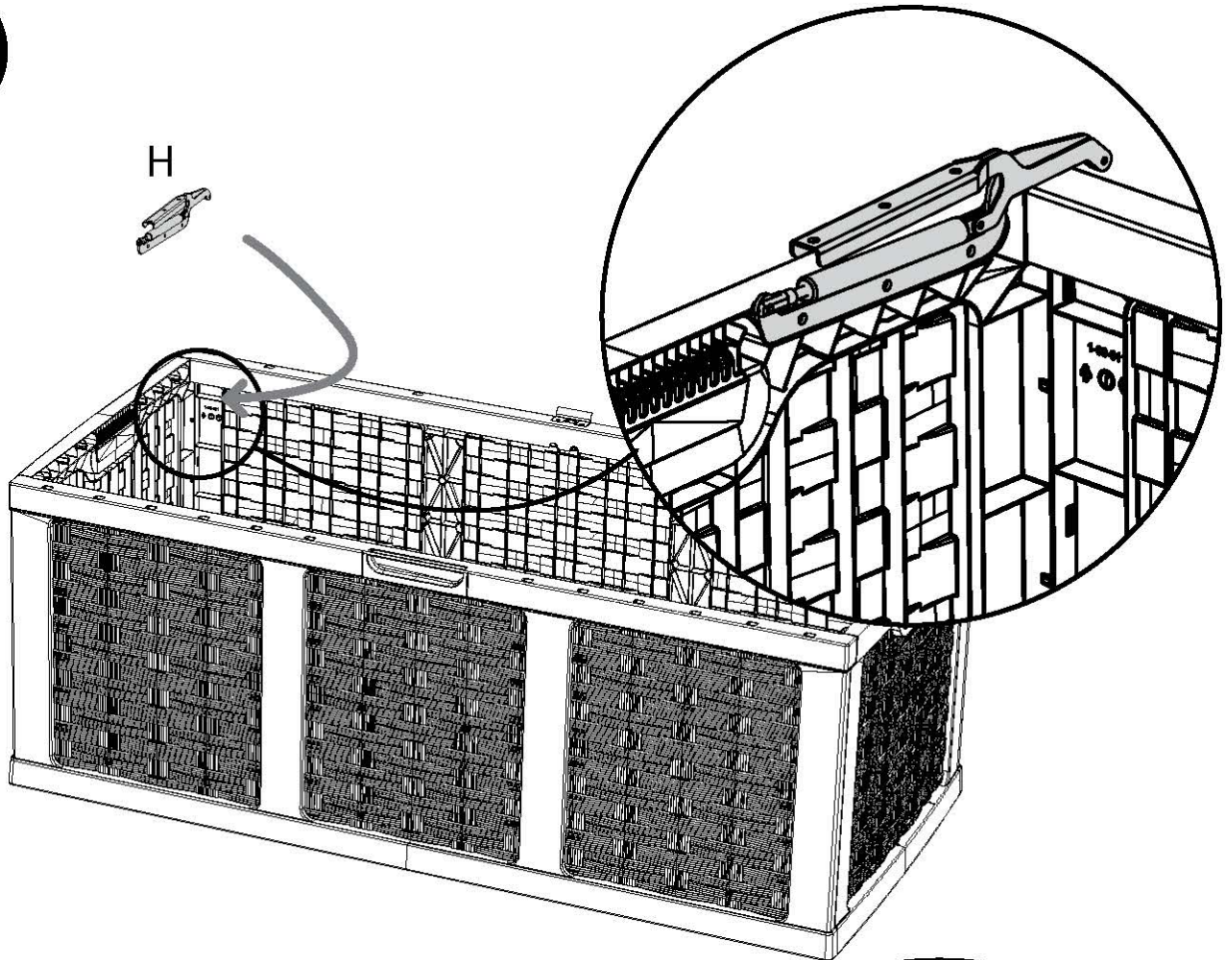

9

H

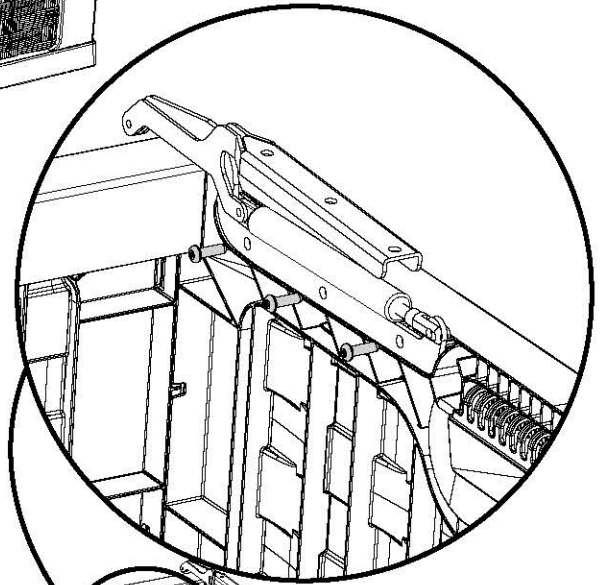
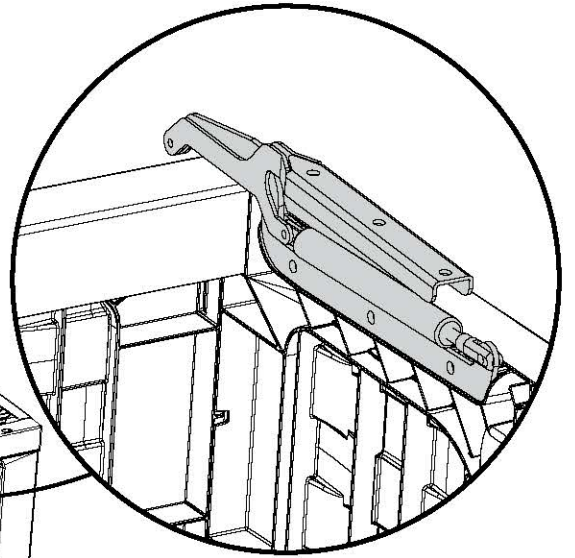
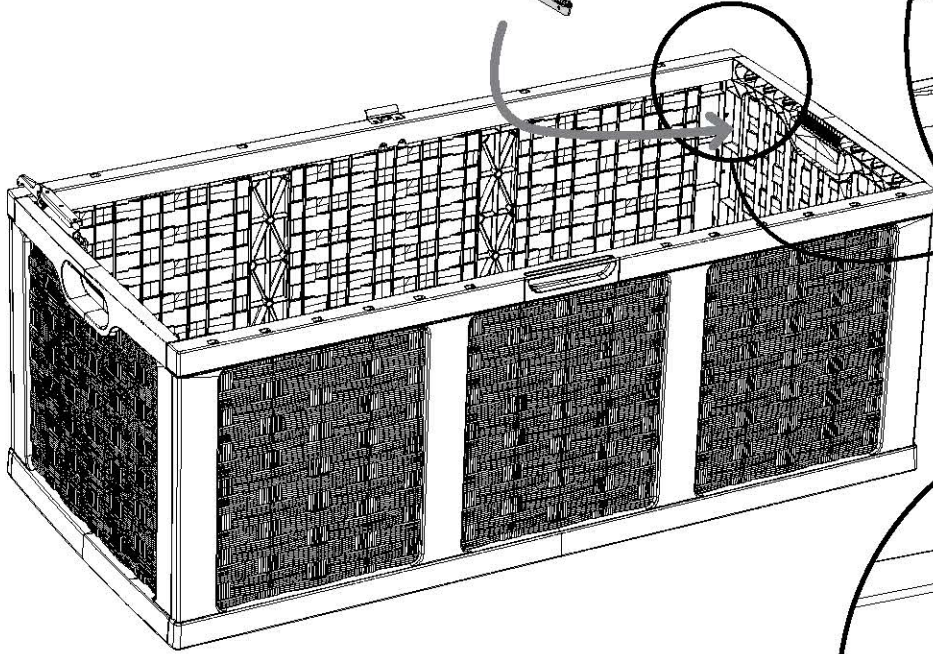

1x3

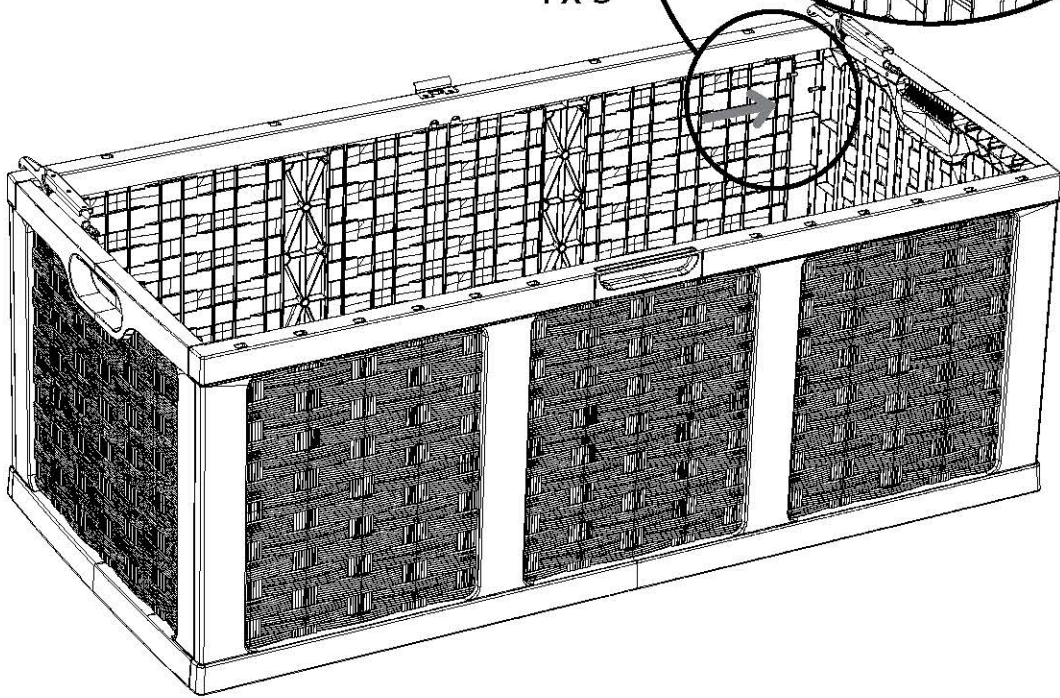

10

D

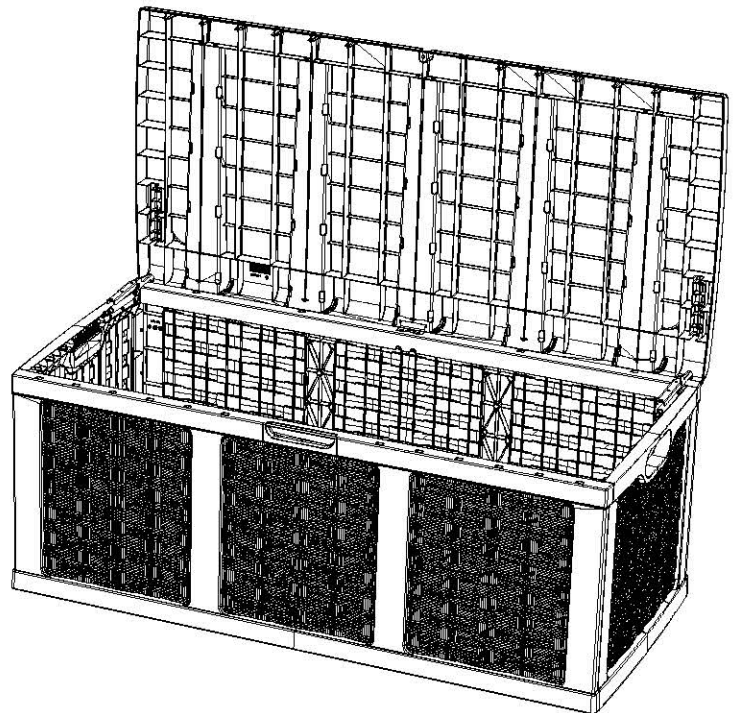
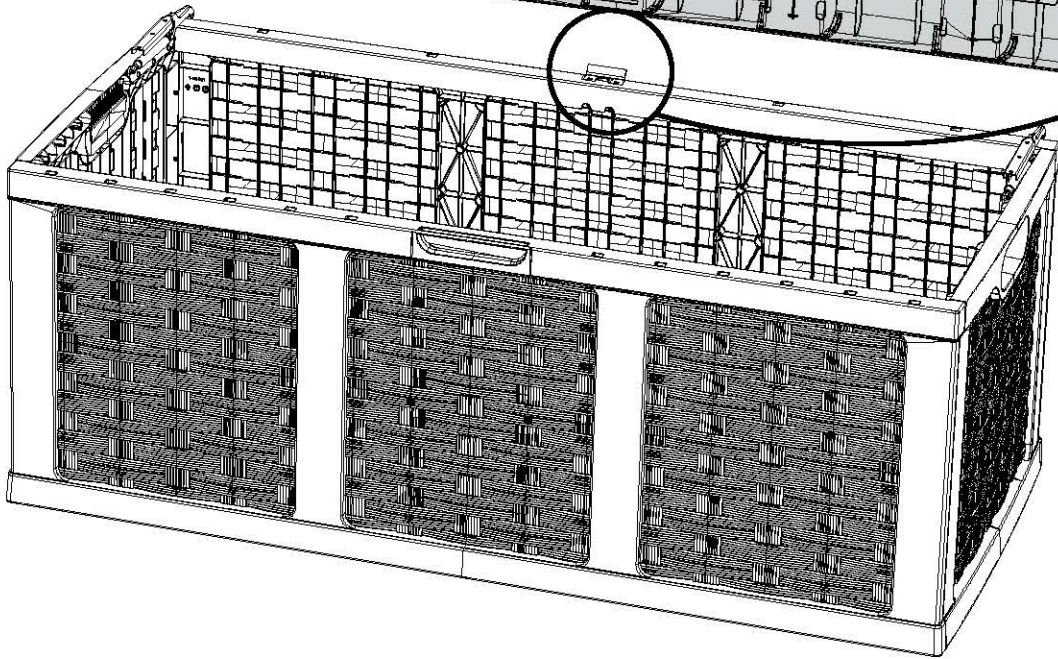
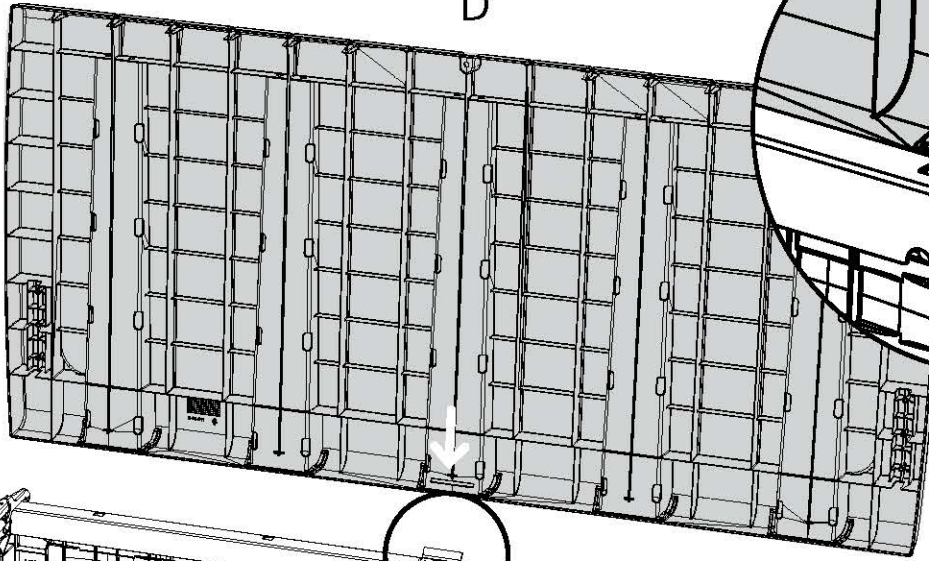
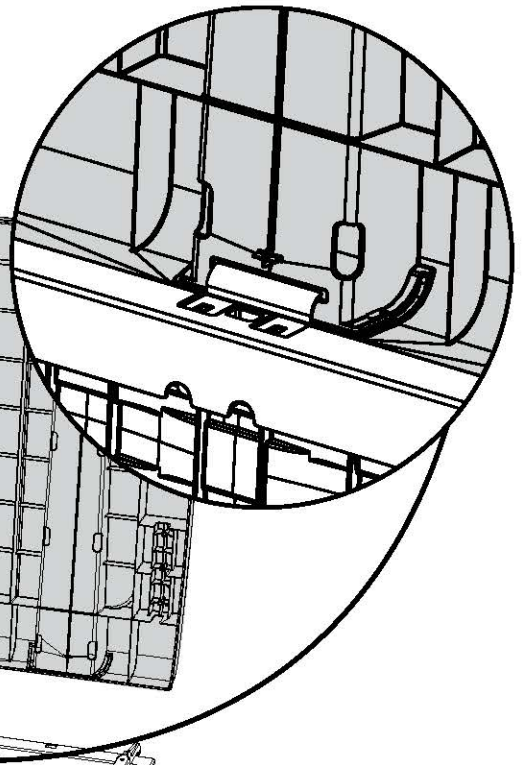

12

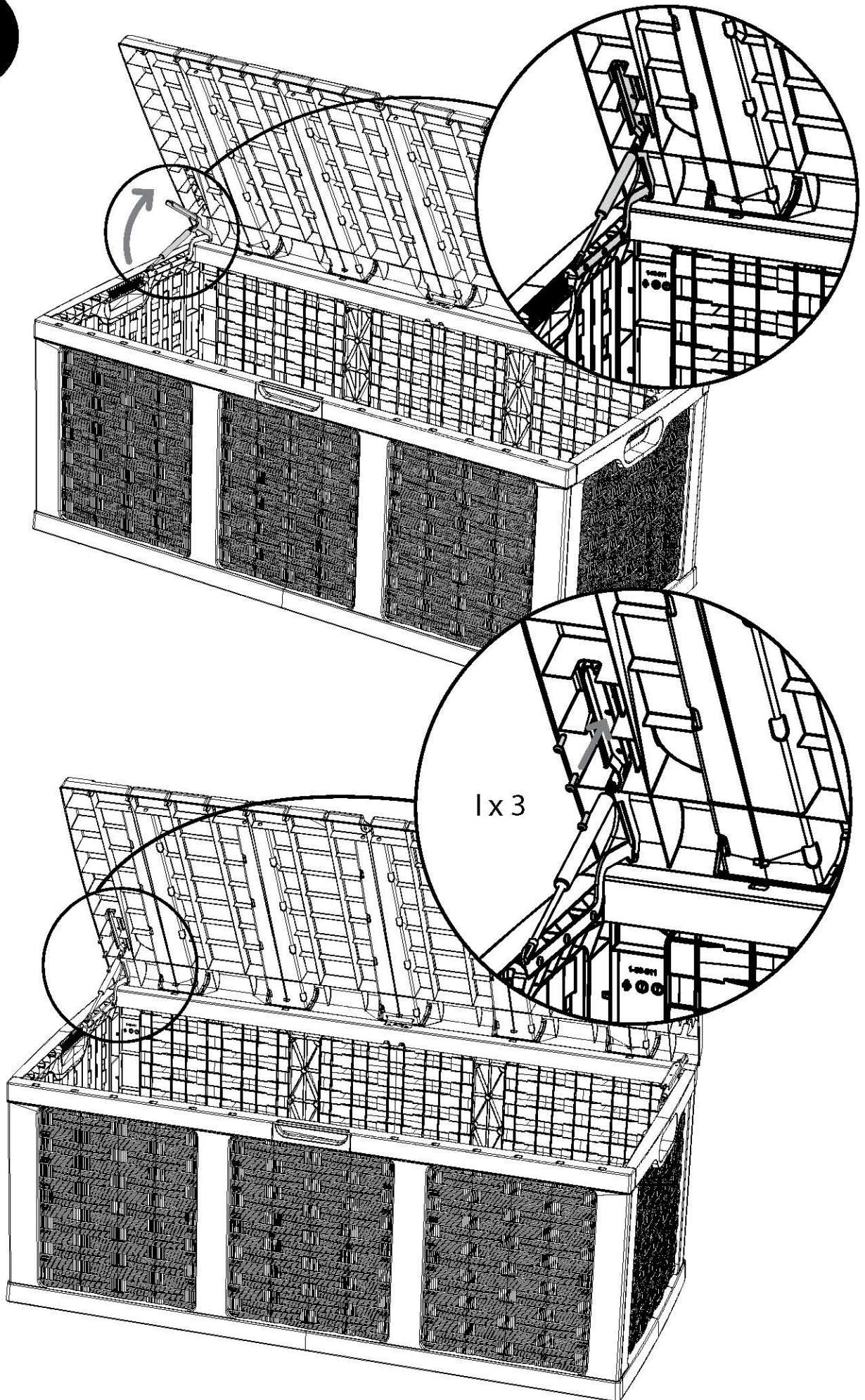

12

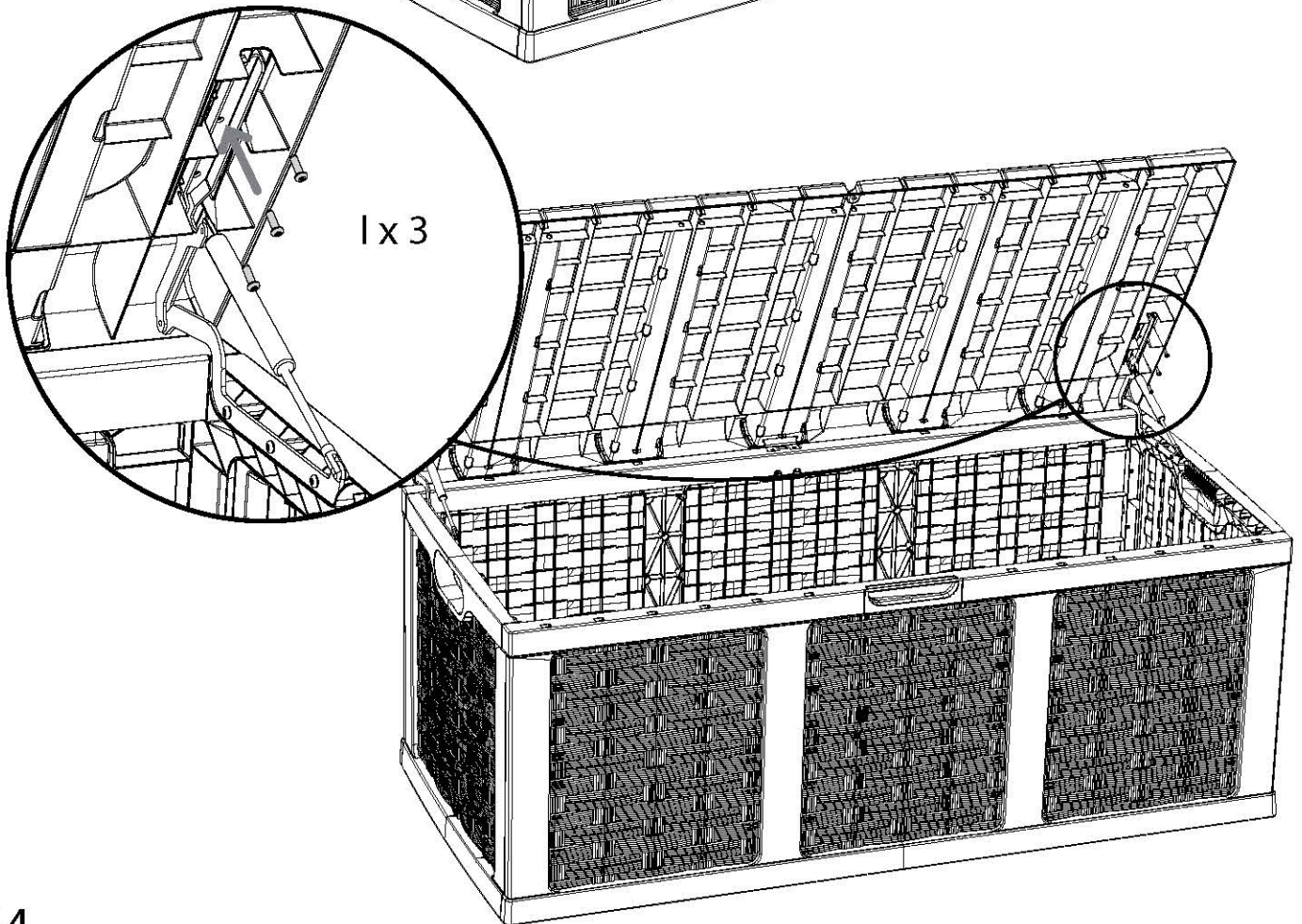
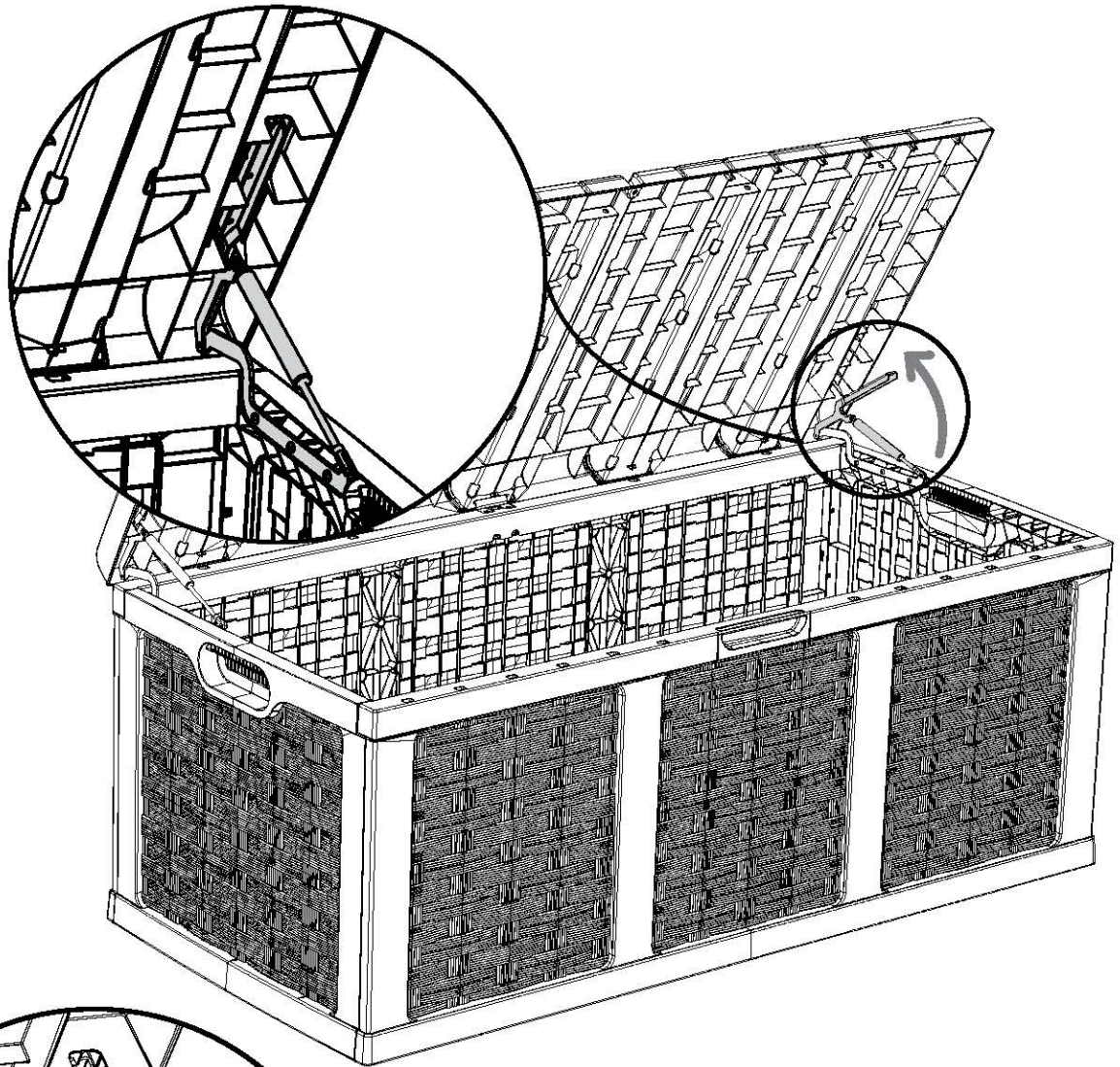

14

13

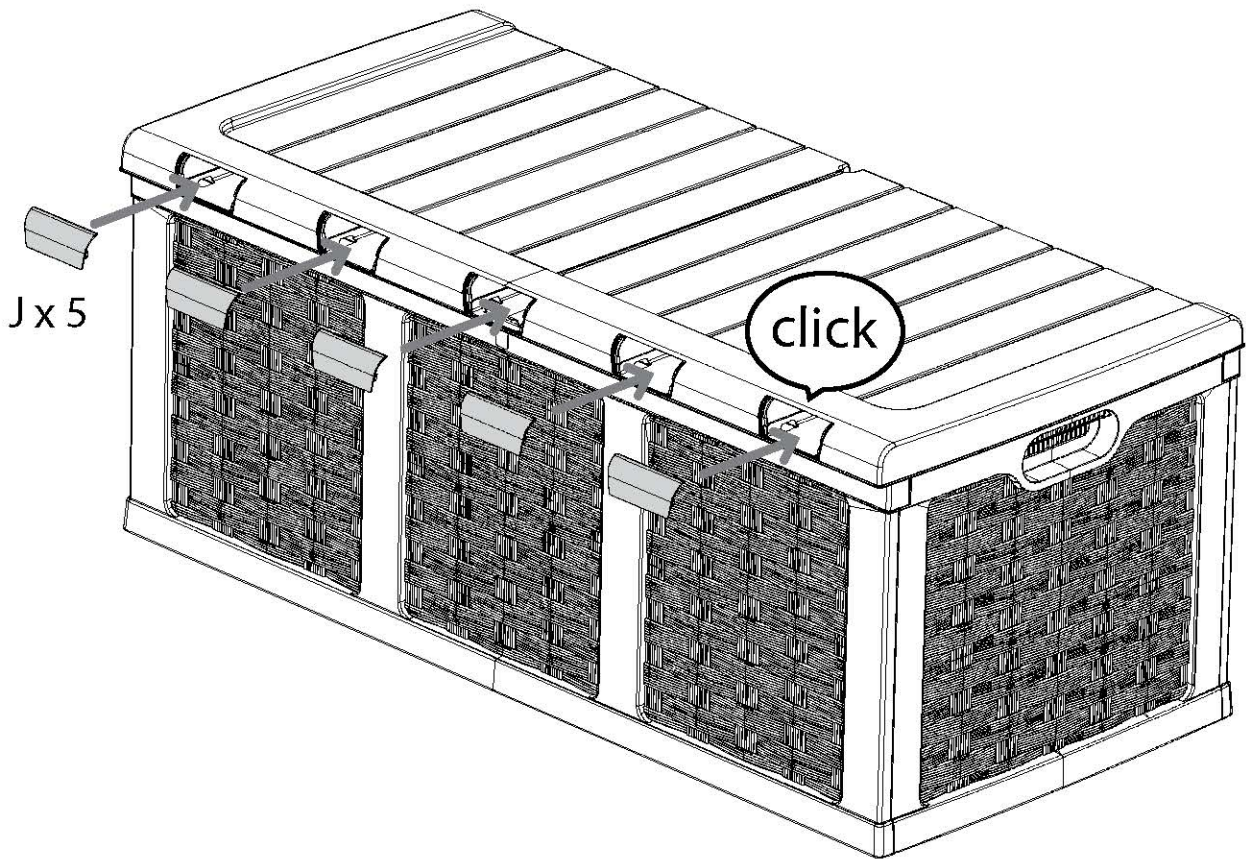

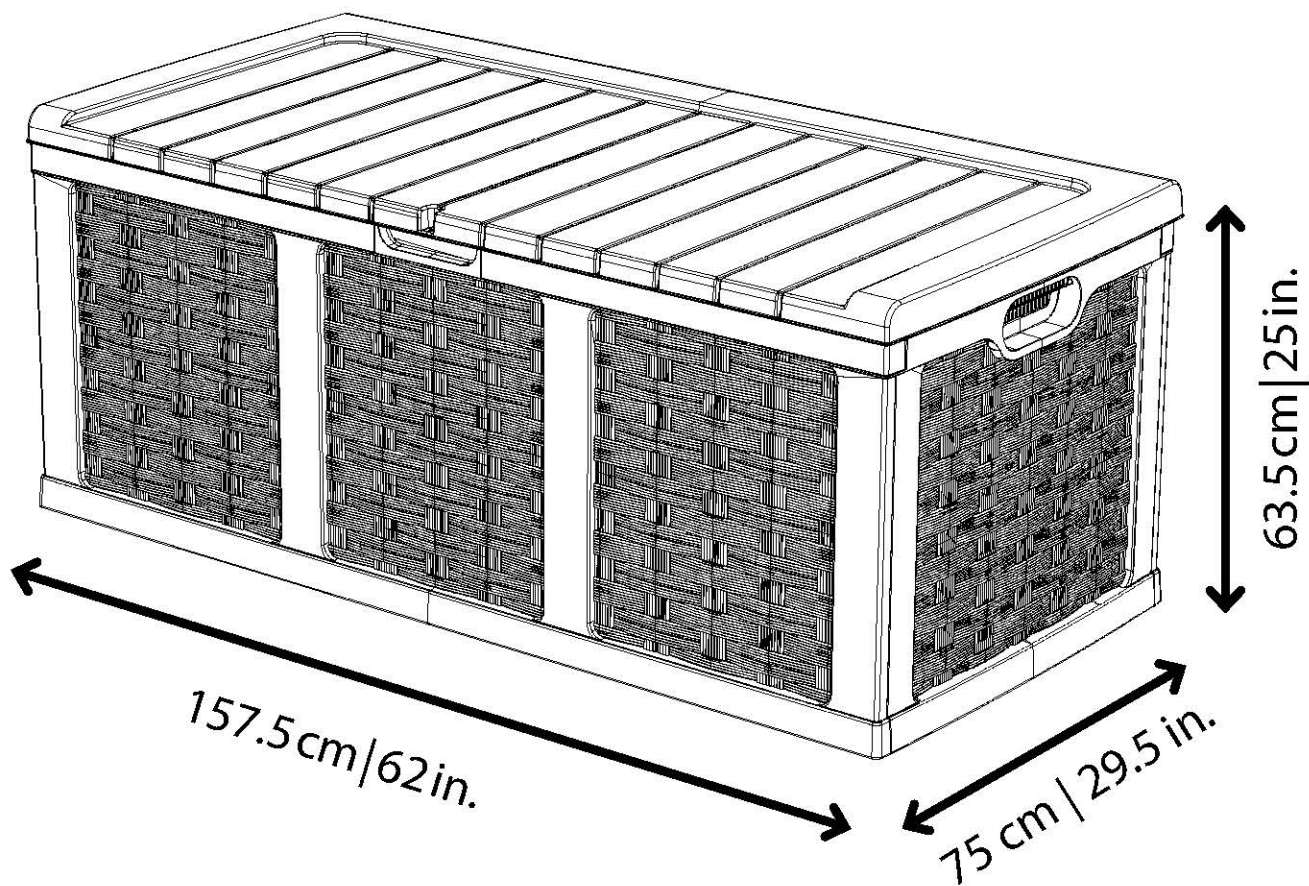

**WARRANTY:**

Starplast Industries Ltd., 32 - Hameginim Street; P.O.B. 1499; Haifa 33262 Israel (Manufacturer) warrants to the original purchaser only that the enclosed product is free from material and workmanship defects under normal, household use at time of purchase.

Replacement for defective or missing parts can be obtained by contacting our distributor, The Mazel Company, 31000 Aurora Road, Solon, Ohio 44139 • Phone (440) 248-8527 or by contacting them via email at [Parts@mazelcompany.com](mailto:Parts@mazelcompany.com). Please be prepared to provide the original receipt and date of purchase. The defective product or part will be repaired or replaced at the option of the distributor without charge to the original purchaser.

**272-0954**

