

Rinnai

Operation / Installation Manual

Rinnai continuous flow water heaters

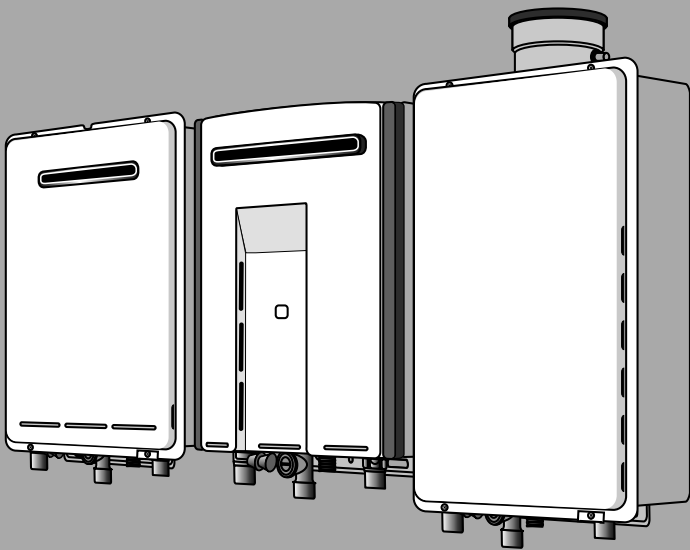

To Suit Water Heater Models -

INFINITY 32	REU-VR3237WG
INFINITY 26	REU-VR2626WG
INFINITY 26 Plus	REU-VRM2630WD
INFINITY 26i	REU-VR2632FFUG
INFINITY 20	REU-VR2024WG
INFINITY 16	REU-VR1620WG
INFINITY ENVIRO 32	REU-KM3237WD
INFINITY ENVIRO 26	REU-KM2635WD
B16	REU-VR1620WB
B20	REU-VR2024WB
B24	REU-VR2426WB
HD250e	REU-VRM3237WC
HD200e	REU-VRM2632WC
HD200i	REU-VRM2632FFUC

This appliance shall be installed in accordance with:

- Manufacturer's Installation Instructions
- Current AS/NZS 3000, AS/NZS 3500 & AS/NZS 5601
- Local Regulations and Municipal Building Codes including local OH&S requirements

This appliance must be installed, maintained and removed by an Authorised Person.

For continued safety of this appliance it must be installed operated and maintained in accordance with the manufacturers instructions.



The Australian
Gas Association
All Rinnai gas products
are A.G.A. certified.



N10378

Certified
Product



WaterMark
AS3498 Lic W208
SAI Global

TABLE OF CONTENTS

REGULATORY INFORMATION	1
WARNING ABOUT HOT WATER	1
FEATURES AND BENEFITS	2
IMPORTANT INFORMATION	3
OPERATION WITHOUT CONTROLLERS	5
GENERAL WATER CONTROL INFORMATION	6
MAXIMUM DELIVERY TEMPERATURES.....	6
UNIVERSAL WATER CONTROLLERS	8
ABOUT THE UNIVERSAL WATER CONTROLLER (MC-91Q).....	8
TURNING ON THE CONTROLLER.....	8
ADJUSTING TEMPERATURE.....	8
HOW TO USE TWO OR MORE UNIVERSAL WATER CONTROLLERS	9
TRANSFERRING PRIORITY	9
ADJUSTING TEMPERATURE.....	9
DELUXE BATHROOM WATER CONTROLLERS	10
ABOUT THE DELUXE BATHROOM WATER CONTROLLER (BC-100V)	10
TURNING ON THE CONTROLLER.....	10
SETTING THE SOUND OPTIONS	11
SETTING THE CLOCK	11
ADJUSTING TEMPERATURE.....	11
OPERATING THE SHOWER SAVER / BATH FILL FUNCTION	12
USING MULTIPLE WATER CONTROLLERS	13
COMBINING UNIVERSAL AND DELUXE WATER CONTROLLERS	13
DELUXE KITCHEN WATER CONTROLLERS	14
ABOUT THE DELUXE KITCHEN WATER CONTROLLER (MC-100V)	14
TURNING ON THE CONTROLLER.....	14
SETTING THE SOUND OPTIONS	14
SETTING THE CLOCK	15
ADJUSTING TEMPERATURE.....	15
SMARTSTART® PRE-HEAT OPERATION	16
ABOUT THE SMARTSTART® PREHEAT SYSTEM.....	16
TROUBLESHOOTING	17
INSTALLATION MANUAL	20
ACCESSORIES	36
PRODUCT RECORDS	36
CONTACT INFORMATION	37

REGULATORY INFORMATION

Your Rinnai Continuous Flow water heater has been certified by the Australian Gas Association. The A.G.A. Certification Number is shown on the data plate.

This Appliance must be installed correctly by an authorised person. The installation of gas, water, and electricity must conform to local regulations.

The installation must also comply with the instructions supplied by Rinnai.

All dimensions referred to in these instructions are in millimetres, unless otherwise specified.

Please keep this instruction booklet in a safe place for future reference.

Notice to Victorian Consumers

This appliance must be installed by a person licensed with the Plumbing Industry Commission.

Only a licensed person will have insurance protecting their workmanship.

So make sure you use a licensed person to install this appliance and ask for your Compliance Certificate. For Further information contact the Plumbing Industry Commission on 1800 015 129.

WARNING ABOUT HOT WATER



Heated water can be dangerous, especially for young children and the infirm.

Water temperatures above 50°C can cause severe burns instantly and may even result in death.

Those most at risk are children, disabled, elderly and the infirm.

Hot water at 65°C (a very common hot water temperature in Australia) can severely burn a child in less than half a second. At 50°C it takes five minutes.

ALWAYS.....

Test the temperature of the water with your elbow before placing your child in the bath, also carefully feel water before bathing or showering yourself.

Supervise children whenever they are in the bathroom.

Make sure that the hot water tap is turned off tightly.

CONSIDER.....

Installing child proof tap covers or child resistant taps (both approaches will prevent a small hand being able to turn on the tap).

Setting your appliance at a maximum temperature of 50°C (Contact Rinnai Australia).

NEVER.....

Leave a toddler in the care of another child. They may not understand the need to have the water temperature set at a safe level.

FEATURES AND BENEFITS

Congratulations on purchasing the latest technology temperature controlled Rinnai continuous flow water heating system.

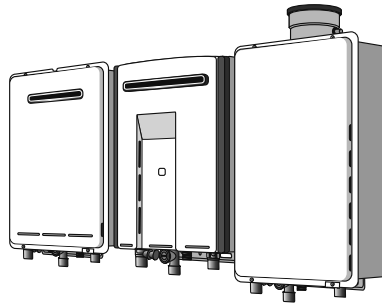

- The Rinnai Continuous Flow water heater products NEVER RUN OUT of hot water. Whilst electricity, water and gas supplies are connected, hot water is available whenever hot water taps are open.
- Built into the main micro-processor is the facility to LIMIT THE MAXIMUM TEMPERATURE of the hot water supplied. The water temperature may be limited to various values. This is particularly useful when the hot water unit is installed where young children or the infirm may be using the hot water.
- The Rinnai Continuous Flow water heater products are power flued appliances. This makes them COMPACT, saving both floor and wall space.
- The temperature of hot water is CONSTANTLY MONITORED by a BUILT-IN SENSOR. If the temperature of the hot water rises to more than 3°C above the selected temperature the burner is turned OFF and only turned ON again when the temperature falls below the selected temperature.
- The burner lights automatically when the hot water tap is opened, and goes out when the tap is closed. IGNITION IS ELECTRONIC, so there is no pilot light. When the hot water tap is off, no gas is used.
- The "Smartstart®" system when fitted can pre-heat the water in the pipe-work between the water heater and the hot water outlets. This results in water savings and reduces waiting time for heated water at the outlets.
- 'Deluxe' or 'Universal' Water Controllers are available as an optional extra. Depending on the models chosen, these offer the following features:
 - Bath fill function (Deluxe Bathroom Control Only).
 - Voice Prompting (Deluxe Control Only).
 - Clock (Deluxe Control Only).
 - Up to four water controllers can be fitted. See page 7 for details.
 - Water controller cables are connected easily by the end user using a convenient quick connect system.
- Operating NOISE LEVEL IS VERY LOW.
- ERROR MESSAGES ARE DISPLAYED on the Water Controllers and Status Monitor*, assisting with service. *Status Monitor available on INFINITY 26 Plus (REU-VRM2630WD), HD250e (REU-VRM3237WC), HD200e (REU-VRM2632WC) and HD200i (REU-VRM2632FFUC) models only.

IMPORTANT INFORMATION



The range of Rinnai continuous flow water heaters referred to in this manual are incompatible with solar water heating systems. A dedicated range of solar compatible continuous flow water heaters is available from Rinnai.

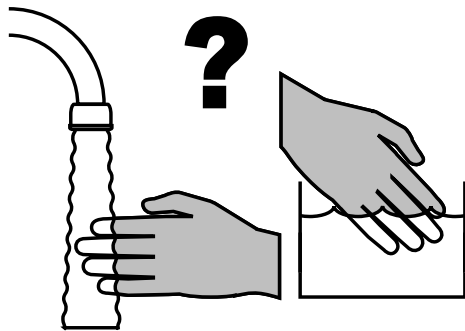

Always check water temperature carefully before use. Refer to the **WARNING ABOUT HOT WATER** on "page 1" of this manual for important safety information.

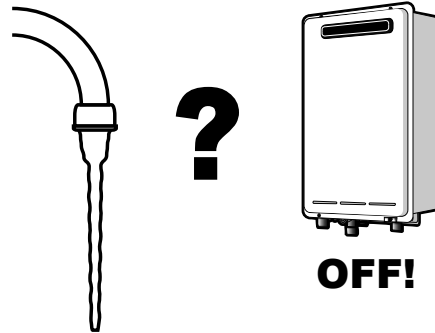

At low water flows, the hot water unit may extinguish without warning. Opening the tap further will restart the appliance.

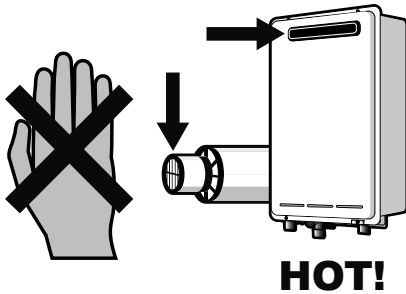

Do Not touch the unit cover or the flue outlet.
Do Not insert objects into the flue outlet.

On colder days steam may discharged from the flue outlet. This condition is normal for high efficiency appliances and does not indicate a fault.



Keep flammable materials, spray cans, fuel containers, pool chemicals, trees, shrubs, etc. well clear of the flue outlet.

Do Not spray water directly into the flue terminal.

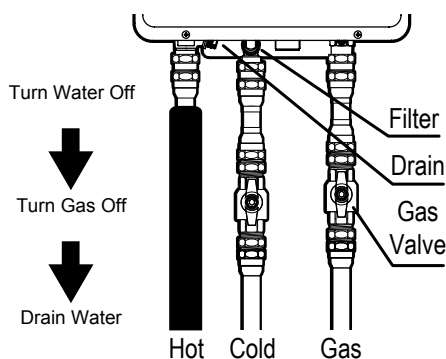

If freezing conditions are expected, turn off water and gas and drain all water from the appliance. If power and the automatic frost protection are connected, freezing will be prevented. (Anti-frost protection is fitted as standard equipment on External units and is available as an optional extra on Internal Units)

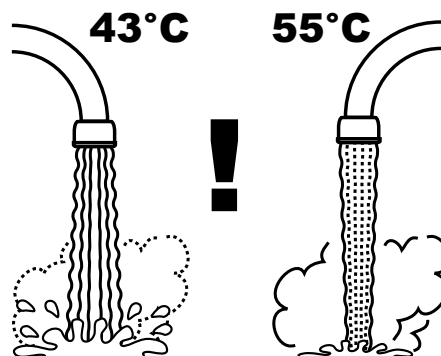

The delivered water temperature is controlled automatically. The flow may vary depending on the delivery temperature selected and the ambient water temperature.



IMPORTANT INFORMATION

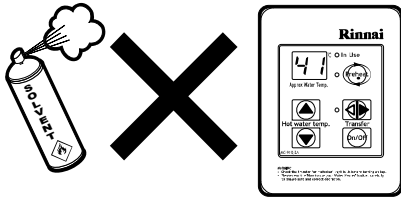

To clean your water controller(s) use a soft damp cloth with a mild detergent.

Do Not use solvents!

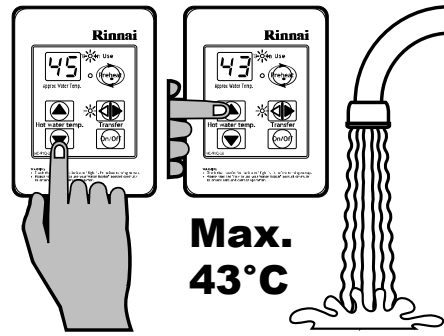

Whilst hot water outlets are open the set temperature may be lowered. However they cannot then be raised above 43°C. In addition transfer of 'priority' between controllers is not possible. These are safety features.

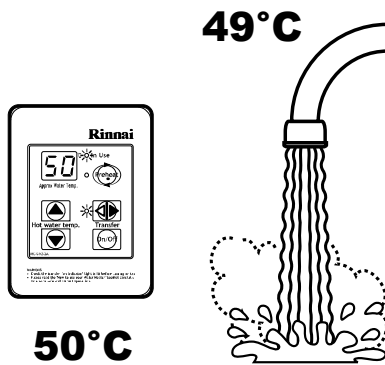

Depending on the weather conditions and the length of the pipe between the hot water unit and the outlet in use, there may be a variation between the temperatures displayed at the water controller(s) and the temperature of the water at the outlet.

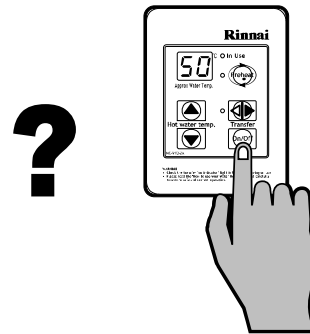

There is no need to turn the water controller(s) off after use. However, if you prefer to turn the water controller(s) off, selected temperatures to a maximum of 50°C will be stored in the system memory at all times whilst mains power remains connected.

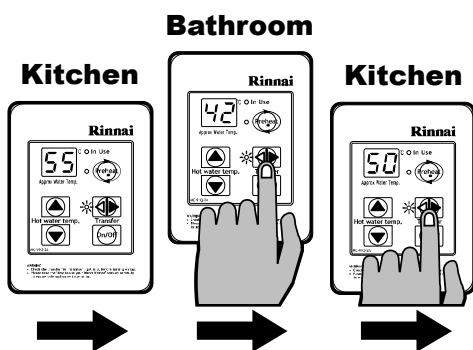

As a safety precaution, if a Kitchen Controller's temperature is set above 50°C, transferring and then returning 'priority' to the Kitchen Controller will result in a default set temperature of 50°C being selected. This is a safety feature.

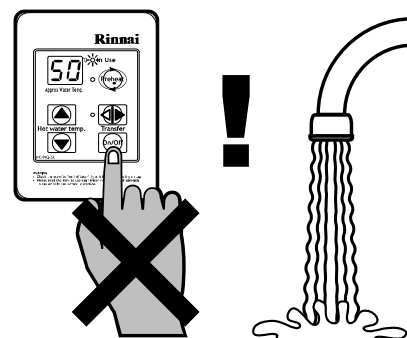

Do Not push the On/Off button on any Controller when the 'Red' water heater 'In Use' indicator is illuminated as this will turn off the water heater causing the water to go cold. Someone maybe in the middle of having a shower or filling a bath.

OPERATION WITHOUT CONTROLLERS

Rinnai Continuous Flow water heater products do not use a pilot light.

When installed and operated without water controllers, the opening of any hot water tap will automatically start the appliance.

Once water is flowing through the appliance the burner will be ignited by electronic ignition.

When the hot water tap is closed and water flowing through the appliance has stopped the burner flame will extinguish.

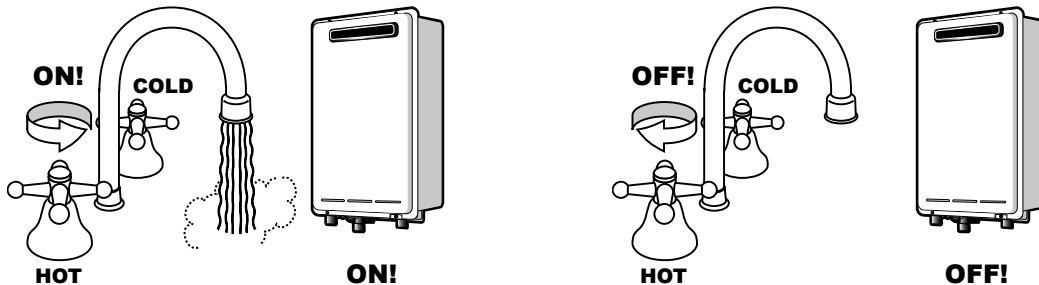

CAUTION

Heated water can be dangerous, especially for young children and the infirm.

Water temperatures above 50°C can cause severe burns instantly and may even result in death.

Those most at risk are children, disabled, elderly and the infirm.

Hot water at 65°C (a very common hot water temperature in Australia) can severely burn a child in less than half a second. At 50°C it takes five minutes.

ALWAYS.....

Test the temperature of the water with your elbow before placing your child in the bath, also carefully feel water before bathing or showering yourself.

Supervise children whenever they are in the bathroom.

Make sure that the hot water tap is turned off tightly.

CONSIDER.....

Installing child proof tap covers or child resistant taps (both approaches will prevent a small hand being able to turn on the tap).

Setting your appliance at a maximum temperature of 50°C (Contact Rinnai Australia).

NEVER.....

Leave a toddler in the care of another child. They may not understand the need to have the water temperature set at a safe level.

GENERAL WATER CONTROL INFORMATION

MAXIMUM DELIVERY TEMPERATURES

Rinnai continuous flow water heaters are factory pre-set to various maximum delivery temperatures depending on model and their intended application. For the majority of applications, the factory pre-set temperature is appropriate. In the unlikely event this is not the case this setting can be increased or decreased by an authorised person such as a licensed plumber.



This does not apply to “50 degree compliant” or “Solar” models. To meet the regulatory requirements for these models, the maximum delivery temperature is factory set and sealed.

Factory pre-set delivery temperatures for the various models are as follows:

MODEL NUMBER Note: The model number is written on the dataplate on the left hand side of appliance	MODEL NAME	FACTORY “PRE-SET” MAXIMUM DELIVERY TEMPERATURE (°C)	CAN FACTORY “PRE-SET” MAXIMUM DELIVERY TEMPERATURE BE CHANGED BY AN AUTHORISED PERSON?
REU-VR1620WG	INFINITY 16	60	Yes
REU-VR2024WG	INFINITY 20	60	Yes
REU-VR2626WG	INFINITY 26	60	Yes
REU-VR2632FFUG	INFINITY 26 Internal	60	Yes
REU-VRM2630WD	INFINITY 26 Plus	60	Yes
REU-VR3237WG	INFINITY 32	60	Yes
REU-KM2635WD	ENVIRO 26	60	Yes
REU-KM3237WD	ENVIRO 32	60	Yes
REU-VR1620WG-50	INFINITY 16 - 50°C Compliant	50	No
REU-VR2024WG-50	INFINITY 20 - 50°C Compliant	50	No
REU-VR2626WG-50	INFINITY 26 - 50°C Compliant	50	No
REU-VR3237WG-50	INFINITY 32 - 50°C Compliant	50	No
REU-VR2632FFUG-50	INFINITY 26 Internal - 50°C Compliant	50	No
REU-VR1620WB	B16	60	Yes
REU-VR2024WB	B20	60	Yes
REU-VR2426WB	B24	60	Yes
REU-VR1620WB-50	B16 - 50°C Compliant	50	No
REU-VR2024WB-50	B20 - 50°C Compliant	50	No
REU-VR2426WB-50	B24 - 50°C Compliant	50	No
REU-VRM2632WC	HD200e	75	Yes
REU-VRM2632FFUC	HD200i	75	Yes
REU-VRM3237WC	HD250e	75	Yes
REU-VRM2632WC-50	HD200e - 50°C Compliant	50	No
REU-VRM2632FFUC-50	HD200i - 50°C Compliant	50	No
REU-VRM3237WC-50	HD250e - 50°C Compliant	50	No

GENERAL WATER CONTROL INFORMATION

Remote water controllers allow precise temperature control by the user. When used correctly, the hot water unit will deliver the selected temperature, even when the water flow is varied, or more than one tap is in use. Each water controller can be individually programmed, however the water heater can only deliver one set temperature at any time. The available temperatures (°C) are as follows:

Kitchen Controller:

37, 38, 39, 40, 41, 42, 43, 44, 45, 46, 48, 50, 55*, 60*, 65* and 75°C*

Bathroom Controller:

Hot Water Delivery: 37, 38, 39, 40, 41, 42, 43, 44, 45, 46, 48, 50°C

Bath fill Delivery: 37, 38, 39, 40, 41, 42, 43, 44, 45, 46, 47, 48°C

Whilst hot water outlets are open the set temperature may be lowered. However the set temperature cannot then be raised above 43°C. In addition, transfer of 'priority' between water controllers is not possible. These are safety features.

Suggested temperatures are:

Kitchen 50°C ~ 55°C* Shower 37°C ~ 43°C, Bath fill 39°C ~ 45°C

* Temperature may not be available refer to "Delivery Temperatures".

These temperatures are suggestions only. You may find higher or lower temperatures more comfortable. Maintaining lower temperatures helps save energy. To obtain water temperatures lower than 37°C simply add cold water.

Water controllers are an optional extra. 'Universal' and 'Deluxe' water controllers can be fitted. Universal water controllers allow temperature selection only. Deluxe water controllers allow temperature selection, shower saver / bath fill and have a clock function.

Water controllers allow the water temperature to be set from the various locations where they are installed. The temperature selected will be available to all outlets.

Universal (MC-91Q) and Deluxe (MC/BC-100V) Water Controllers - available configurations:

All Models	<p>A maximum of 4 water controllers can be fitted. Any combination of both deluxe and universal controllers can be used with the following provisions:</p> <p>Only <u>ONE</u> MC-100V water controller can be installed.</p> <p>Up to <u>TWO</u> BC-100V water controllers can be installed.</p> <p>The <u>FOURTH</u> water controllers in any installation MUST BE a MC-91Q.</p>
-------------------	---

UNIVERSAL WATER CONTROLLERS

ABOUT THE UNIVERSAL WATER CONTROLLER (MC-91Q)

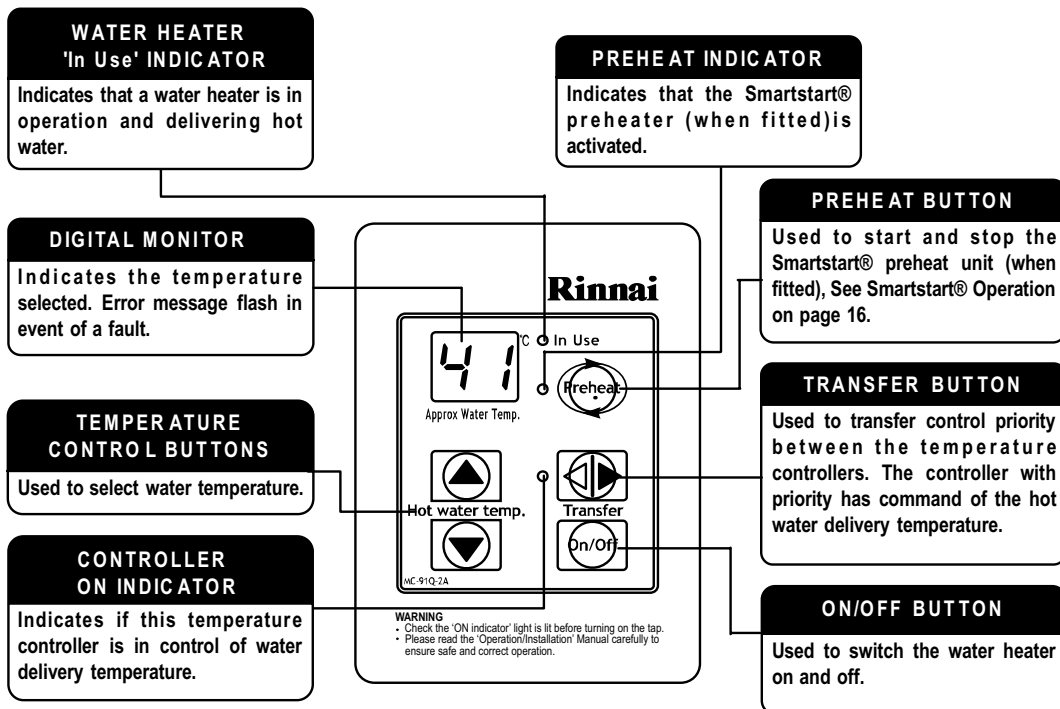

TURNING ON THE CONTROLLER

If the water controller is switched off (No digits displayed in the digital monitor window) press the On/Off button once.

The ON indicator will illuminate, indicating that the hot water unit will be ready to supply hot water once a hot water tap is opened.

ADJUSTING TEMPERATURE

Select the desired temperature using the 'Hot water temp' or buttons until the required temperature is displayed on the digital monitor.

To operate the hot water unit, open any hot water tap. This will automatically light the burner providing hot water. The water heater 'In Use' indicator will illuminate on the water controller.

Once the hot water is running, if the set temperature is either too hot or cold press the 'Hot water temp' or buttons until the desired temperature is reached.

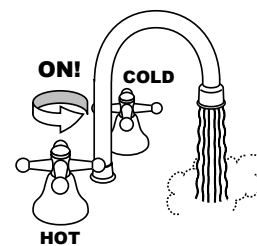
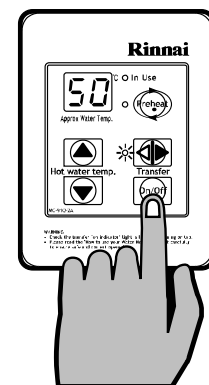

CHECK WATER TEMPERATURE BEFORE USE.

A parent or carer should always check the temperature before a child is placed in contact with hot water, see page 5.



Whilst hot water outlets are open the set temperature may be lowered. However they cannot then be raised above 43°C. In addition, transfer of 'priority' between controllers is not possible. These are safety features.

The 'beep' sound can be muted by pressing the 'Hot water temp' Up and Down buttons simultaneously for more than 3 seconds.

UNIVERSAL WATER CONTROLLERS

HOW TO USE TWO OR MORE UNIVERSAL WATER CONTROLLERS

TURNING ON THE CONTROLLERS

If the controllers are switched off (No digits displayed in the digital monitor window) press the On/Off button once at any controller.



The ON indicator on the desired controller will illuminate, indicating that the hot water unit will be ready to supply hot water once a hot water tap is opened.

TRANSFERRING PRIORITY



An illuminated On/Off indicator confirms that the desired controller is in control of the water delivery temperature, if the On/Off indicator is not illuminated press the TRANSFER button once.

The On/Off indicator on the controller will now illuminate indicating that hot water temperature control has now been transferred to this controller and that the hot water unit will be ready to supply hot water once a hot water tap is opened.

ADJUSTING TEMPERATURE

Select the desired temperature using the 'Hot water temp'  or  buttons until the required temperature is displayed on the digital monitor.

To operate the hot water unit, open any hot water tap. This will automatically light the burner providing hot water. The water heater 'In Use' indicator will illuminate on the water controller.

Once the hot water is running, if the set temperature is either too hot or cold press the 'Hot water temp'  or  buttons until the desired temperature is reached.

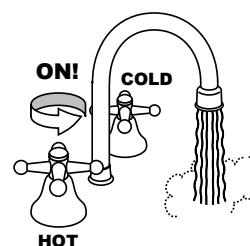
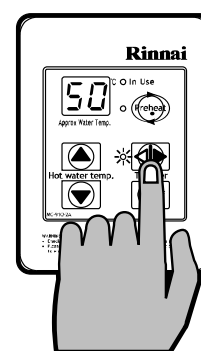
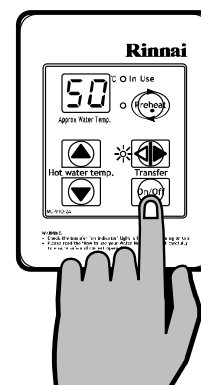

CHECK WATER TEMPERATURE BEFORE USE.

A parent or carer should always check the temperature before a child is placed in contact with hot water, see page 5.



Whilst hot water outlets are open the set temperature may be lowered. However they cannot then be raised above 43°C. In addition transfer of 'priority' between controllers is not possible. These are safety features.

Temperatures higher than 50°C should not be able to be selected on controllers installed in bathrooms, ensuites or toilets. This is to help reduce the risk of burns from hot water. If this is not the case, the controllers have been incorrectly installed. CONTACT YOUR INSTALLER.

The temperature of outgoing hot water is constantly monitored by a built-in sensor. If the temperature of the outgoing hot water rises to more than 3°C above the selected temperature shown on the digital monitor or the pre-set limit when water controllers are not fitted, the burner will automatically go out. The 'in use' indicator will also go out. The burner will ignite again once the outgoing hot water temperature falls to that shown on the digital monitor (or the pre-set limit of the appliance).

DELUXE BATHROOM WATER CONTROLLERS

ABOUT THE DELUXE BATHROOM WATER CONTROLLER (BC-100V)

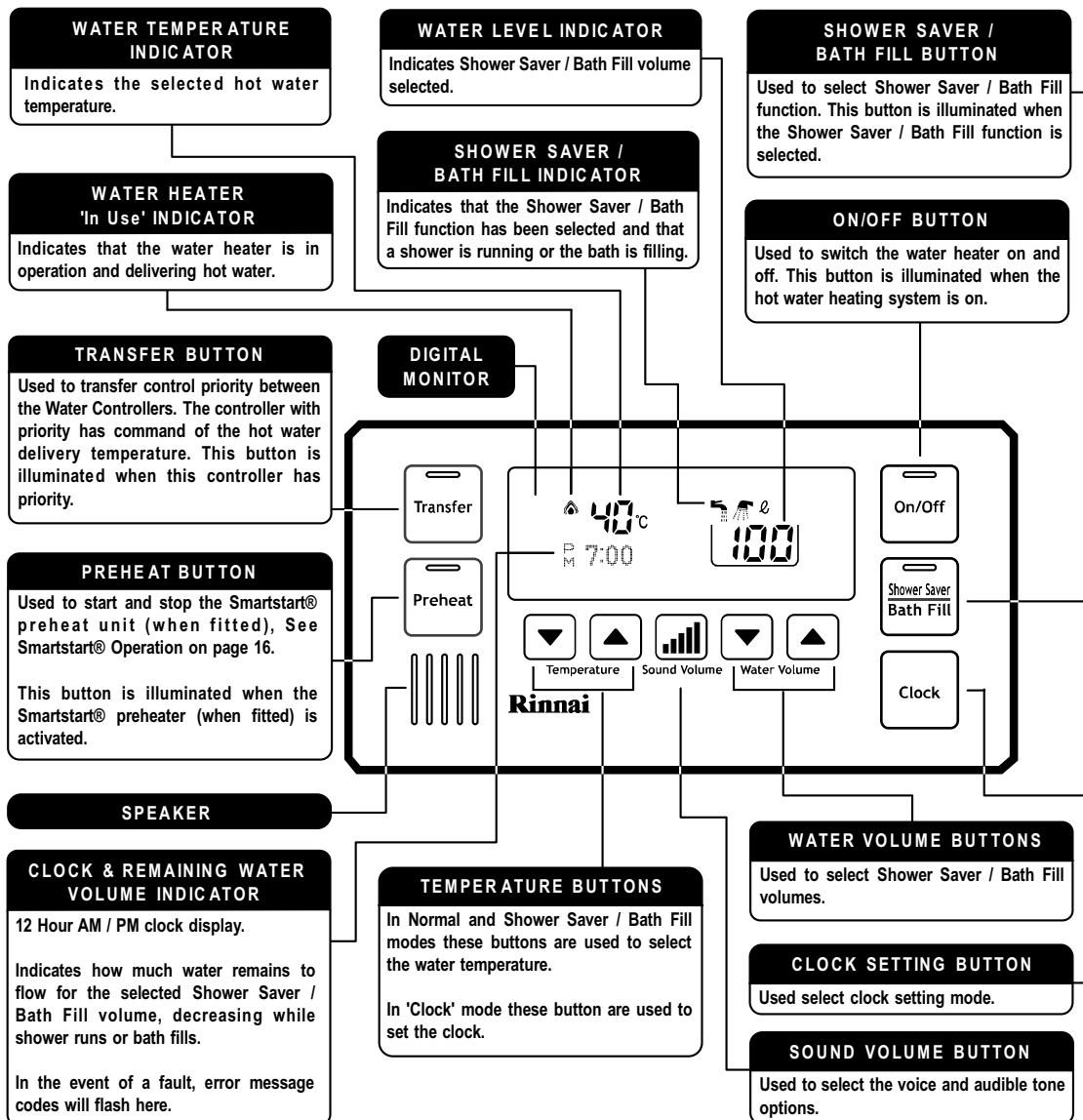

NOTE Refer to page 7 to confirm the maximum number and combination of controllers that can be fitted to your Water Heater model.

Avoid getting water directly in the speaker as this may cause damage.

TURNING ON THE CONTROLLER

If the controller is switched off (No digits other than the clock digits displayed in the digital monitor) press the On/Off button once.

The On/Off and Transfer buttons illuminate to indicate that the hot water unit will be ready to supply hot water once a hot water tap is opened.

If more than one controller is fitted press the 'Transfer' button to transfer priority to the desired controller.

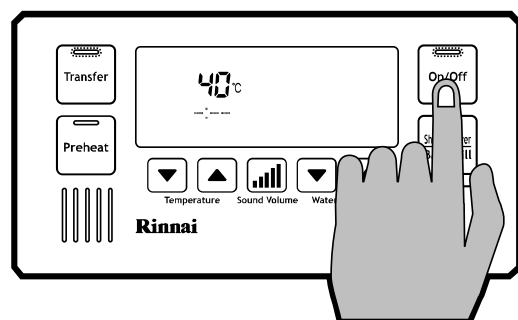

DELUXE BATHROOM WATER CONTROLLERS

SETTING THE SOUND OPTIONS

To set the sound options press the 'Sound Volume'  button and select the desired audible setting as follows:

Voice High, Med, Low or Off, sets the voice prompt volume but does not affect the audible tones.
Sound OFF, mutes all voice prompts and audible tones.

Press any of the ▲ or ▼ buttons to return to normal mode, if no buttons are pressed for a period of approximately 10 seconds the controller will return to normal mode

SETTING THE CLOCK

The clock is a 12 hour AM/PM style display.

To set the time press the 'Clock'  button once, this places the controller into clock setting mode, in the digital monitor the clock digits will flash, if this is the first time the clock has been set the starting time will be AM 12:00.

Use the 'Temperature' ▲ or ▼ buttons to select the desired time, holding these buttons down continuously cycles the digits. When you get close to the time you wish to set, press the button intermittently to avoid going further than the desired time.

To return to normal mode press the 'Clock'  button once, if no buttons are pressed for a period of approximately 60 seconds the controller will return to normal mode.

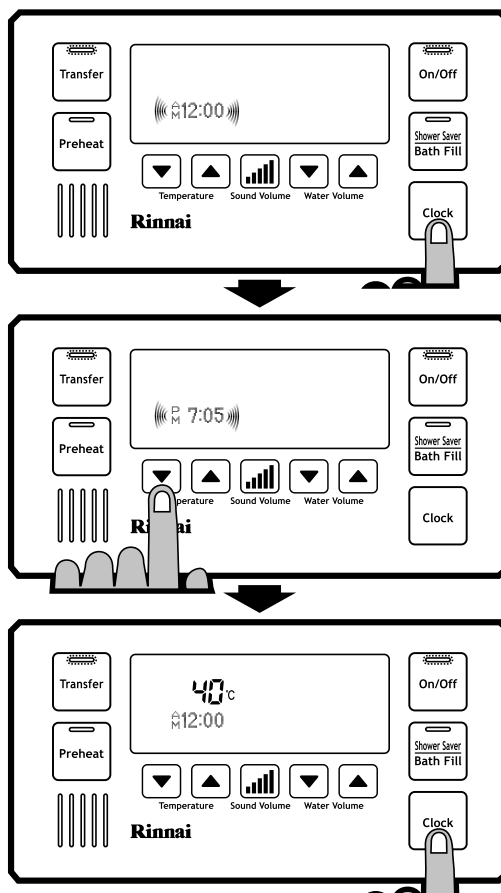

The time is always displayed regardless of whether the water controller is turned ON or OFF.

The clock may need resetting if power to the water heater unit is disrupted due to a power failure or if the power is switched off over a prolonged period.

ADJUSTING TEMPERATURE

Simply press the 'Temperature' ▲ or ▼ buttons until the required temperature is displayed on the digital monitor.

To operate the water heater, open any hot water tap. This will automatically light the burner, providing hot water. The 'In Use' indicator  will illuminate on all water controllers.

Once the hot water is running, if the set temperature is either too hot or cold press the 'Temperature' ▲ or ▼ buttons until the desired temperature is reached.

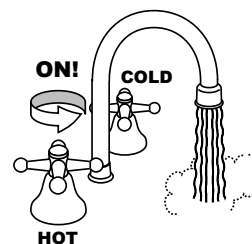

Whilst hot water outlets are open the set temperature may be lowered. However it cannot then be raised above 43°C. In addition, transfer of 'priority' between controllers is not possible. These are safety features.



CHECK WATER TEMPERATURE BEFORE USE.

A parent or carer should always check the temperature before a child is placed in contact with hot water, see page 5.

DELUXE BATHROOM WATER CONTROLLERS

OPERATING THE SHOWER SAVER / BATH FILL FUNCTION

The 'Shower Saver / Bath Fill' function allows a preset water volume and temperature to be selected and run automatically.





No voice prompts will be available if the 'Voice OFF' or 'Sound OFF' options are selected. With 'Sound OFF' there will also be no audible tones.

Initial Settings

When a deluxe bathroom controller is first turned on, the default shower / bath temperature is set to 40°C and the shower / bath volume is set to 100 litres. The shower / bath volume can be lowered to a minimum of 30 litres or raised to a maximum of 400 litres and the temperature adjusted as desired.



Setting Shower / Bath Temperature and Volume

With the system on, select a Deluxe Bathroom water controller and ensure that it currently has priority. If it does not have priority press the 'Transfer'  button once and the 'Transfer' button will illuminate.

Press 'Shower Saver / Bath Fill'  button once. The 'Shower Saver / Bath Fill' button will illuminate and a voice prompt and tone will sound.

To select the desired delivery temperature use the 'Temperature'  or  buttons.

The selected temperature will be displayed on the digital monitor and will remain as the default 'Shower Saver / Bath Fill' temperature until it is changed or if the mains power is turned off for an extended period.

To select the volume of water to be used in the shower / bath use the 'Water Volume'  or  buttons. The selected volume is displayed in large digits to the right and will remain as the default 'Water Volume' until it is changed or if the mains power is turned off for an extended period.

The selected volume is also repeated in the form of a remaining volume counter below the temperature and replaces the clock during 'Shower Saver / Bath Fill' operations.

When filling a bath for the first time, it is recommended that a low bath fill volume such as 60 litres or lower be used. During any subsequent bath fills the volume can then be adjusted to suit your known bath volume and or desired fill level.



Be careful not to overfill the bath, an average bath volume is 160 litres. It is recommended that when filling a bath for the first time you should:

- Remain by the bath during the filling process.
- Use a low bath fill volume such as 60 litres or less.

When Smartstart® (page 16) is in operation, the Shower Saver / Bath Fill function is unavailable while the water heater 'In Use' indicator  is illuminated. Do not press the Preheat button whilst Shower Saver / Bath Fill is in operation as the programmed bath fill volume will not be met.

Using Shower Saver / Bath Fill

Press 'Shower Saver / Bath Fill'  button once. The 'Shower Saver / Bath Fill' button will illuminate and a voice prompt and tone will sound. During 'Shower Saver / Bath Fill' operations the 'Bath' indicator will also be displayed in the Deluxe Kitchen water controller digital monitor (when fitted).

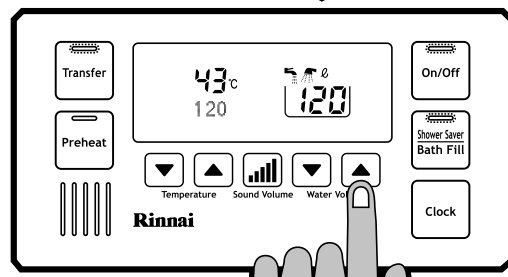
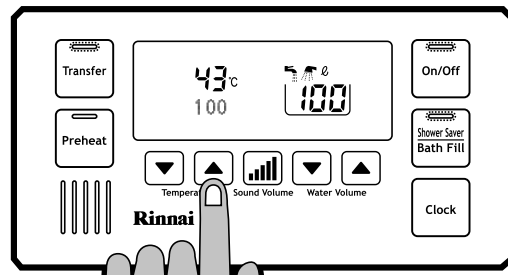
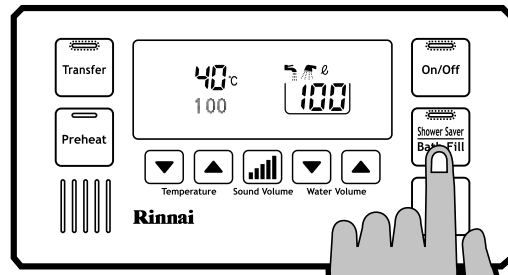

DELUXE BATHROOM WATER CONTROLLERS

The voice prompt will say "The hot water system is ready. Open the hot water tap". Open the hot water tap for the relevant shower or bath.

The 'In Use' indicator  will illuminate on all Deluxe water controllers and the shower will run or the bath will start to fill.

To Stop Shower Saver / Bath Fill Operation

If you wish to stop the water flow whilst the Shower Saver / Bath Fill function is in operation, simply press the 'Shower Saver / Bath Fill'  button.

The 'Shower Saver / Bath Fill' button will flash and the voice prompt will say "Hot water is not available, Turn off all hot water taps and push the 'Bath Fill' button". Follow the voice prompt instructions.

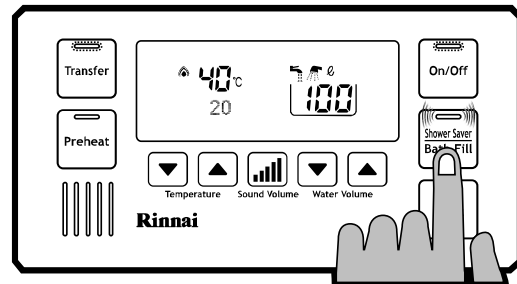
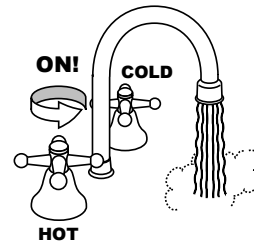

When Shower Saver / Bath Fill Operations Finishes

Once the Shower Saver / Bath Fill operation finishes the following events will occur:

1. The flow from the shower / bath hot water tap ceases.
2. The 'Shower Saver / Bath Fill' button will flash.
3. The Deluxe Kitchen water controller 'Bath' indicator will flash.
4. A tone will sound.
5. The voice prompt will say "Bath fill is complete. Turn off the bath hot water tap and push the Bath Fill button."

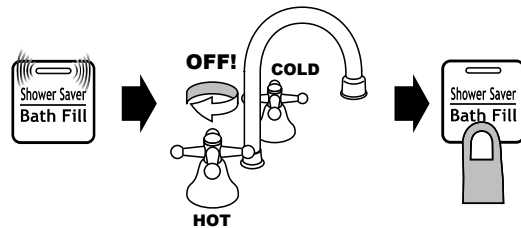

Follow the voice prompts instructions. Note that the water heater will not allow hot water to flow from any fixture until the 'Shower Saver / Bath Fill'  button has been pressed.

6. The 'Shower Saver / Bath Fill' button light on the Deluxe Bathroom water controller and the 'Bath' indicator on the Deluxe Kitchen water controller monitor (when fitted) will go out.



CHECK WATER TEMPERATURE BEFORE USE.

A parent or carer should always check the temperature before a child is placed in contact with hot water, see page 5.

NEVER LEAVE YOUNG CHILDREN UNATTENDED IN THE BATH.

When using the 'Shower saver / Bath fill' function, ALWAYS close the hot water tap for the bath or shower after the flow has stopped.



Whilst hot water outlets are open the set temperature may be lowered. However it cannot then be raised above 43°C. In addition transfer of 'priority' between controllers is not possible. These are safety features.

USING MULTIPLE WATER CONTROLLERS

The water heater can be turned on and off at any water controller. If more than one water controller is fitted press the 'Transfer'  button to transfer priority to the desired controller.

COMBINING UNIVERSAL AND DELUXE WATER CONTROLLERS

Universal and Deluxe water controllers can be combined and will function as described in other sections of the Water Heater Operation / Installation Manual. Refer to page 7 to confirm the maximum number and combination of controllers that can be fitted to your water heater model.

DELUXE KITCHEN WATER CONTROLLERS

ABOUT THE DELUXE KITCHEN WATER CONTROLLER (MC-100V)

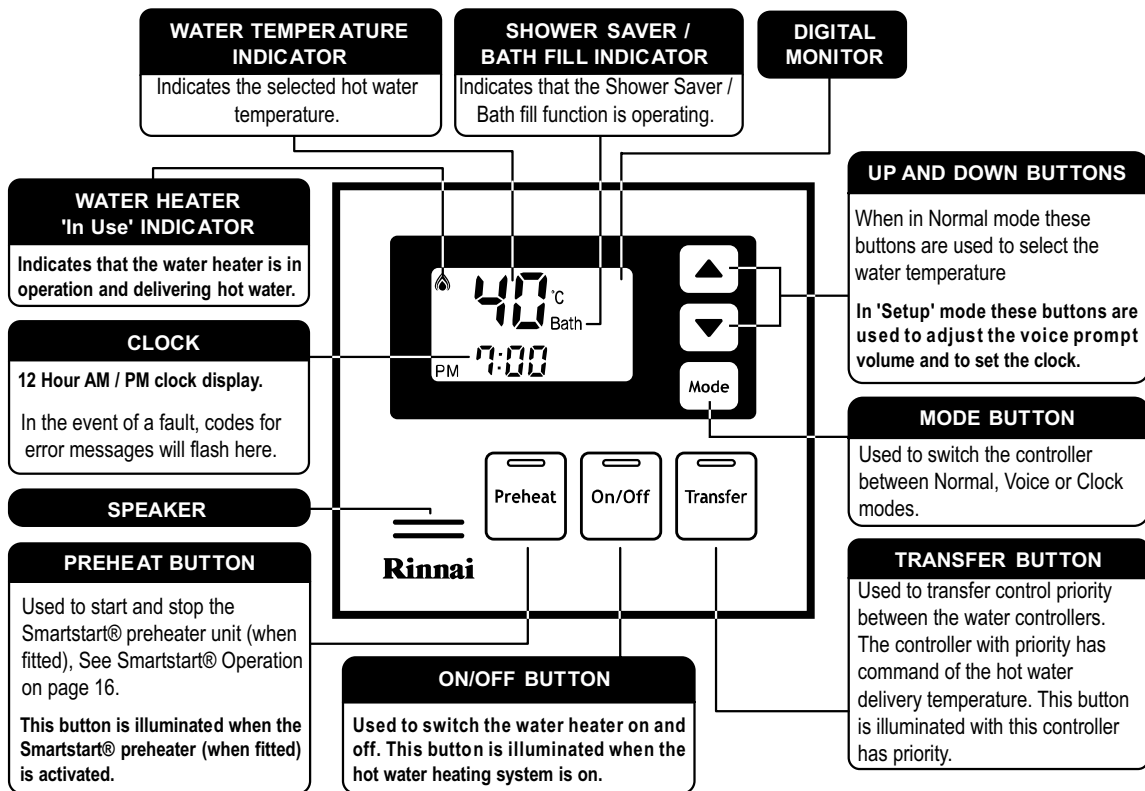

NOTE Only one MC-100V may be fitted to your water heater. Refer to page 7 to confirm the maximum number and combination of controllers that can be fitted to your Water Heater model.

The MC-100V controller is not water resistant, avoid direct exposure to water or steam as these conditions may cause a malfunction.

TURNING ON THE CONTROLLER

If the controller is switched off (No digits other than the clock digits displayed in the digital monitor) press the On/Off button once.

The On/Off and Transfer buttons illuminate to indicate that the hot water unit will be ready to supply hot water once a hot water tap is opened.

If more than one controller is fitted press the 'Transfer'  button to transfer priority to the desired controller.

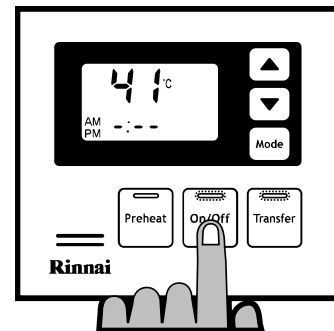

SETTING THE SOUND OPTIONS

To set the sound options press the 'Mode'  button once to place the controller into 'Voice' mode.

Use the ▲ or ▼ buttons to select the desired audible setting as follows:

Voice High, Med, Low or Off, sets the voice prompt volume but does not affect the audible tones.

Sound Off, mutes all voice prompts and audible tones.

To return to normal mode press the 'Mode'  button once, if no buttons are pressed for a period of approximately 10 seconds the controller will return to normal mode.



NOTE Voice prompts only available when Deluxe Bathroom water controller(s) are installed.

DELUXE KITCHEN WATER CONTROLLERS

SETTING THE CLOCK

The clock is a 12 hour AM/PM style display. To set the time press the 'Mode'  button twice. This places the controller into clock setting mode and in the digital monitor the word 'Clock' will be displayed and the clock digits will flash. If this is the first time the clock has been set the starting time will be AM 12:00.

Use the ▲ or ▼ buttons to select the desired time. Holding these buttons down continuously cycles the digits. When you get close to the time you wish to set, press the button intermittently to avoid going further than the desired time.

To return to normal mode press the 'Mode'  button once. If no buttons are pressed for a period of approximately 10 seconds the controller will return to normal mode.

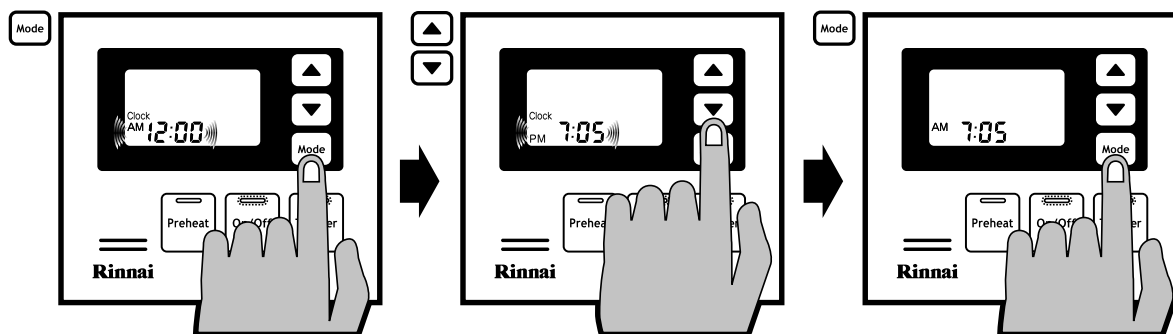

The time is always displayed regardless of whether the water controller is turned ON or OFF.

The clock may need resetting if power to the water heater unit is disrupted due to a power failure or if the power is switched off over a prolonged period.

ADJUSTING TEMPERATURE

Simply press the 'hot water temp' ▲ or ▼ buttons until the required temperature is displayed on the digital monitor.

To operate the water heater, open any hot water tap. This will automatically light the burner, providing hot water. The 'In Use' indicator  will illuminate on the water controller.

Once the hot water is running, if the set temperature is either too hot or cold press the ▲ or ▼ buttons until the desired temperature is reached.

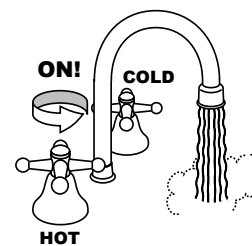

Whilst hot water outlets are open the set temperature may be lowered. However it cannot then be raised above 43°C. In addition transfer of 'priority' between controllers is not possible. These are safety features.



CHECK WATER TEMPERATURE BEFORE USE.

A parent or carer should always check the temperature before a child is placed in contact with hot water, see page 5.

SMARTSTART® PRE-HEAT OPERATION

ABOUT THE SMARTSTART® PREHEAT SYSTEM

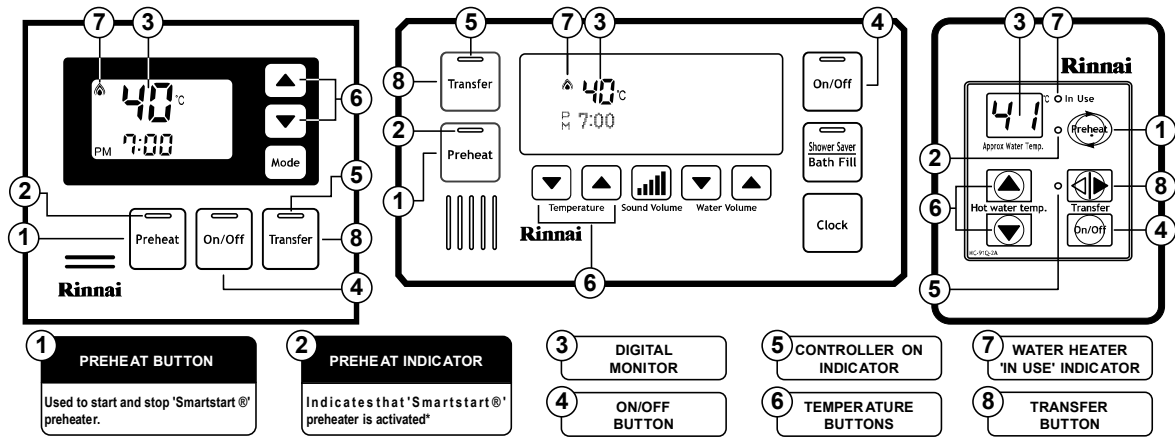

Preheat Function

The “Preheat” function works in conjunction with various Rinnai water heater models and the separately installed and optional Rinnai “Smartstart®” module.

When the “Preheat” function is activated and used in accordance with these instructions, water in the pipework connected between the water heater and the hot water outlets in your house is warmed before any outlets are opened. This results in water savings and added convenience.

The “Preheat” function is activated as follows:

1. Ensure that the hot water unit is on (temperature digits are displayed in the digital monitor ③). If more than one controller is fitted press the ‘Transfer’ ⑧ button to pass on priority to your desired controller, the ‘Controller On’ ⑤ indicator will illuminate to confirm that priority has been assigned to this controller and that the hot water unit is ready to deliver hot water.
2. Select the desired temperature using the ‘Temperature’ ⑥ buttons until the required temperature is displayed in the digital monitor ③.
3. Press the ‘Preheat’ ① button once. The ‘Preheat’ ② indicator and the ‘In Use’ ⑦ indicators will illuminate, signifying that the preheat system has been activated.
4. Wait approximately two minutes before opening an outlet. This will allow the water in the pipework to be warmed.



NOTE

The waiting time may be longer or shorter than two minutes depending on your particular installation configuration.

The “Preheat” function is cancelled 5 minutes after activation and the ‘Preheat’ indicator will go out. This is to conserve energy. To reactivate, simply repeat steps 2-4 above.

* If the ‘Preheat’ button is pressed and the ‘Smartstart®’ preheat unit is not installed, the ‘Preheat’ indicator will still light but there will be no “Preheat” function. The ‘Preheat’ indicator will go out after a short time and will not affect the other functions of the water controller or water heater.

After using the Shower Saver / Bath Fill function wait 30 seconds before activating the “Preheat” function. Attempting to use the “Preheat” function earlier will result in voice prompts being repeated until the system is reset. The system can be reset by pressing the ‘On /Off’ button twice.

Other Controller Functions

Controller functions such as temperature control and transfer of priority between multiple controllers is not affected by the operation of the preheat. Such functions are described in the applicable sections of this manual.

TROUBLESHOOTING

Your Rinnai Continuous Flow water heaters has a self diagnostic capability. If a fault occurs, an Error Code will flash on the digital monitor or status monitor* if you have water controllers. This assists with diagnosing the fault, and may enable you to overcome a problem without a service call. Please quote the code displayed when enquiring about service. *Status Monitor available REU-VRM2630WD, HD250e and HD200e and HD200i models only.

ERROR	FAULT	REMEDY
-	Noticeable reduction in water flow.	Inlet water filter needs to be cleaned. Service call.
03	Power interruption during Bath fill (Water will not flow on power reinstatement).	Turn off all hot water taps. Press On/Off twice.
10	Air intake or flue blocked.	Service Call.
11	No ignition / No gas supply.	Check gas is turned on at water heater and gas meter or cylinder.
12	Flame Failure / Low gas flow.	Check gas is turned on at water heater and gas meter or cylinder. Check there are no obstructions to the flue outlet.
14	Remaining Flame Safety Device.	Service Call.
16	Over Temperature Warning.	Service Call.
25	Condensate Pipe Blockage	Check for blockage on condensate drain path.
32	Outgoing Water Temperature Sensor Faulty.	Service Call.
33	Heat Exchanger Outlet Sensor Faulty.	Service Call.
34	Combustion Air Temperature Sensor Faulty.	Service Call.
52	Gas Modulating Valve Faulty.	Service Call.
61	Combustion Fan Failure.	Service Call.
65	Water Flow Control Faulty (Does not stop flow properly).	Service Call.
71	Micro-processor Failure.	Service Call.
72	Micro-processor Failure.	Service Call.
LC	Scale build-up inside the heat exchanger.	Service Call.

In all cases, you may be able to clear the Error Code simply by turning the hot water tap OFF, then ON again. If this does not clear the Error Code, try pushing the On/Off button OFF, then ON again. If the Error Code still remains, contact Rinnai for advice.

Troubleshooting Without Controllers

If you have no water controllers and experience the following symptoms, carry out these suggestions. If the symptom continues, contact Rinnai for advice.

FAULT	REMEDY
The unit does not attempt to start at all.	Check the power is on at the unit. Check the isolation valves at the unit are open.
The unit starts then shuts down immediately.	Check the power is still on. Check the gas isolation valves at the unit and the gas meter are fully open. Open your hot water tap fully.
The unit starts then the water goes cold.	Check the power is still on. Open your hot water tap further.



Faults caused by insufficient gas supply, insufficient water supply, gas quality, water quality, installation errors or operation errors are not covered by the Rinnai warranty. Refer to separate warranty booklet for details.

INTENTIONALLY BLANK PAGE



INTENTIONALLY BLANK PAGE



INSTALLATION MANUAL

GENERAL INSTALLATION INSTRUCTIONS	21
REGULATIONS	21
APPLICABLE MODELS	21
APPLIANCE LOCATION	21
PIPE SIZING	22
WATER SUPPLY	22
HOT WATER DELIVERY TEMPERATURE	22
WATER HEATER AND CONTROLLER INSTALLATION CONFIGURATIONS	22
MOUNTING THE APPLIANCE	22
SERVICE CONNECTION POINTS	23
HORIZONTAL FLUE TERMINAL CLEARANCES	24
HORIZONTAL OBSTRUCTIONS	25
MULTIPLE INSTALLATIONS OF EXTERNAL MODELS	25
APPLIANCE AND WATER CONTROLLER DIMENSIONS	26
CO-AXIAL FLUEING FOR INTERNAL MODELS	27
CONDENSATE DRAIN (REU-KM' MODELS ONLY).....	28
IMPORTANT CONSIDERATIONS FOR THE CONDENSATE DRAIN PIPE	28
LENGTH AND CHANGES OF DIRECTION	28
INSTALLATION	28
INTERCONNECTION OF CONDENSATE DRAIN LINES	29
COMMON STACK DISCHARGE	29
TUNDISH DRAIN LINES	29
AREAS SUBJECT TO FREEZING	29
WATER CONTROLLER INSTALLATION.....	30
RINNAI WATER CONTROLLERS	30
POSITIONING OF WATER CONTROLLERS	30
WATER CONTROLLER CABLES	30
FITTING THE 'UNIVERSAL' WATER CONTROL (MC-91Q)	30
OPTIONAL PROGRAMMING FOR THE 'UNIVERSAL' WATER CONTROLLER (MC-91Q)	31
FITTING THE 'DELUXE KITCHEN' WATER CONTROLLER (MC-100V)	32
FITTING THE 'DELUXE BATHROOM' WATER CONTROLLER (BC-100V)	32
CONNECTING COMMUNICATION CABLES TO THE WATER HEATER	33
COMMISSIONING	34
TESTING	34
DELIVERY TEMPERATURE	34
GAS PRESSURE SETTING	35
COMMISSIONING CHECK LIST	35
ACCESSORIES	36
PRODUCT RECORDS	36
CONTACT INFORMATION	37

GENERAL INSTALLATION INSTRUCTIONS

REGULATIONS

This appliance must be installed in accordance with:

- Current AS/NZS 3000, AS/NZS 3500 and AS/NZS 5601
- Rinnai Installation Instructions
- Local regulations and municipal building codes including local OH&S requirements

Installation, Service and Removal MUST BE by an Authorised Person only.

APPLICABLE MODELS

These Installation Instructions apply only to the following Rinnai Continuous Flow Water heater models are listed on the cover page of this manual.

APPLIANCE LOCATION

(External Models)

This appliance is designed for 'Outdoor' Installation only. As such, it must be located in an above ground open air situation with natural ventilation, without stagnant areas, where gas leakage and products of combustion are rapidly dispersed by wind and natural convection.

This appliance must be mounted on a vertical structure with the water and gas connections on the underside pointing downwards. For appliances installed on elevated structures or under floors specific requirements apply. Refer to AS/NZS 5601 Section 6 for details.

This appliance must not be used as a domestic spa or swimming pool heater.

Location of the appliance flue terminal must be in accordance with Section 6 and Figure 6.2 of AS/NZS 5601. Figure 6.2 is reproduced in the 'Horizontal Flue Terminal Clearances' section of these instructions. Note that AS/NZS 5601 was current at the time of printing but may have been superseded. It is the installers' responsibility to ensure current requirements are met.

(Internal Models)

This appliance is designed for 'Indoor' installation only. It may be installed 'Outdoors' in an enclosure if the requirements of AS/NZS 5601 Section 6 are satisfied. An enclosure is defined as a compartment, enclosed area or partitioned off space primarily used for the installing of the appliance. If installed in an enclosure, either Internally or Externally, the location should be ventilated to allow gas to dissipate and provision must be made for the safe disposal of any leaking water to a visible location.

This appliance must be mounted on a vertical structure with the water and gas connections on the underside pointing downwards. For appliances installed in roof spaces or elevated structures specific requirements apply. Refer to AS/NZS 5601 Section 6 for details.

This appliance must not be used as a domestic spa or swimming pool heater.

Rinnai internal models described in this manual must use the Co-Axial Rinnai FFU flue components. The use of non Rinnai FFU flue components may result in a dangerous situation and violates regulations. The maximum FFU flue length is 9 metres with a maximum of three 90 degree bends. Horizontal (wall) or vertical (roof) terminals are available. For detailed information refer to "CO-AXIAL FLUEING FOR INTERNAL MODELS" on page 27.

This appliance must be located so that the flue terminal exits the building at a suitable point.

If a horizontal (wall) terminal FFWALLTERM is used, the location must be in accordance with Section 6 and Figure 6.2 of AS/NZS 5601. Figure 6.2 is reproduced under 'HORIZONTAL FLUE TERMINAL CLEARANCES' on page 24 of this manual.

If a vertical (roof) terminal FFROOFCOWL is used, the location must be in accordance with Section 6 of AS/NZS 5601 and the "CO-AXIAL FLUEING FOR INTERNAL MODELS" on page 27.



AS/NZS 5601 was current at the time of printing but may have been superseded. It is the installer's responsibility to ensure current requirements are met.

(All Models)

This appliance must be placed as close as practicable to the most frequently used hot water outlet or outlets to minimise the delay time for hot water delivery. For installations where the distance between the water heater and the outlets is considerable, a flow and return system or the Rinnai Smartstart® system can be used which minimise the waiting time for hot water delivery.

GENERAL INSTALLATION INSTRUCTIONS

Alternatively, multiple appliances can be strategically placed to serve outlets with minimal delay time. Contact Rinnai for further information.

An AC240V, 10 Amp, earthed power point must be provided adjacent to the appliance. For outdoor installations this power point must be weather proof. It must be clear of the gas and water connections to the appliance and also the flue exhaust and water pressure relief valve. The power cord of the appliance is 1.5 Metres long.

All appliances must be installed to ensure access can be gained without hazard or undue difficulty for inspection, repair, renewal or operational purposes. Sufficient clearances shall allow access to, and removal of, all serviceable components. Appliances should not be mounted higher than 2.5 metres above the ground or floor level unless the customer can arrange permanent and safe access or can provide another means of access, for example, by means of scissor or boom lifts acceptable to local authorities.

PIPE SIZING

See Table 1 page 23 for appliance gas consumption. If the gas pipe sizing is insufficient the customer will not get the full performance benefit. Gas pipe sizing must consider the gas input to this appliance as well as all the other gas appliances in the premises. The gas meter and regulator must be specified for this gas rate. An approved sizing chart such as the one in AS/NZS 5601 should be used.

Water pipe sizing and layout should be performed in accordance with AS/NZS 3500. All hot water pipe-work should be insulated to optimise performance and energy efficiency.

WATER SUPPLY

See Table 1, page 23 for applicable water pressures. Approved pressure limiting valves may be required if the 'Maximum' rated water supply pressures in Table 1 are exceeded. To achieve the rated flow, the 'Minimum' water supply pressures in Table 1 must be supplied. The water heaters will operate at lower pressures but will not achieve the rated flow. Contact Rinnai for 'gravity fed' or 'low pressure' installations.

Water chemistry and impurity limits are detailed under 'Warranty Conditions'. Most metropolitan water supplies fall within the requirements. If you are unsure about your local water quality, contact your water authority. If sludge or foreign matter is present in the water supply, a suitable filter or strainer should be incorporated in the water supply to the water heater.

HOT WATER DELIVERY TEMPERATURE

Local regulations and or the requirements of AS/NZS 3500 must be considered regarding the temperature limitations of hot water supplied to areas used primarily for personal hygiene. The temperature of water to these areas may be limited to 50° C or less. To ensure these regulations and or requirements are met the system MUST be installed in accordance with the 'Water Heater and Controller Installation Configurations' Section of these instructions.

WATER HEATER AND CONTROLLER INSTALLATION CONFIGURATIONS

If the appliance is marked to state that it delivers water not exceeding 50°C, local regulations may permit it's installation without a Temperature Limiting Device. Installations without a Temperature Limiting Device are shown in Diagram 1 (page 23). If you are unsure about your local regulations contact your regulating authority or Rinnai.

If the appliance is **NOT** marked to state that it delivers water not exceeding 50°C, or your local regulations require installation with a Temperature Limiting Device then install the appliance in accordance with Diagram 2 (page 23).

MOUNTING THE APPLIANCE

See Table 1, page 23 for individual appliance weights. The wall or structure on which the units are to be mounted must be capable of supporting these weights and the associated pipe-work.

The top bracket has a keyhole slot so that the appliance can be positioned by hanging it on one screw, then the other screws can be secured.

The appliance can be mounted directly against the wall or structure. There is no need to use, non combustible sheeting or leave an air gap between the appliance back panel and the wall or structure for the purposes of meeting the temperature hazard requirements of AS/NZS 5601.

GENERAL INSTALLATION INSTRUCTIONS



If the appliance is to deliver water primarily for the purposes of personal hygiene in an early childhood centre, primary or secondary school, nursing home or a similar facility for the care of young, aged, sick or disabled persons as defined in AS/NZ 3500 a Temperature Limiting Device (TLD), such as a Tempering Valve may be required even if the appliance is set to 50° C or less.

For these types of applications contact Rinnai.

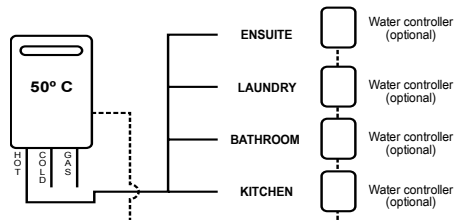

Diagram 1 - 50°C Appliance

Minimum length of pipe from hot outlet to nearest hot water tap 2 metres.

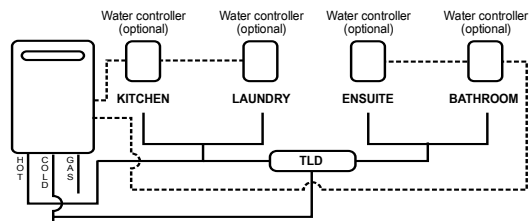

Diagram 2 - Not a 50°C Appliance

Note: TLD = Temperature Limiting Device

Ensure that suitable fixing screws or bolts are used to secure the units to the wall, in accordance with AS/NZS 5601 section 6. Wooden plugs shall not be used.

The top bracket has a keyhole slot so that the appliance can be positioned by hanging it on one screw, then the other screws can be secured.

SERVICE CONNECTION POINTS

See Table 1 for individual appliance connection / fitting dimensions. Note that these dimensions are NOT an indication of the pipe sizes required.

An Approved full flow isolation valve and disconnection union MUST be fitted to the cold water inlet. A non return valve is not required unless required by local regulations.

Isolation Valves must not be fitted directly to the appliance.

If may be necessary to fit a temperature limiting device for delivery to areas used primarily for the purposes of personal hygiene. Refer to the 'Water Heater and Controllers Installation Configurations' Section of this document.

Purge gas and cold water supply lines to remove air and swarf before final connection of the appliance. Swarf in either the gas or water supplies may cause damage.

Model:	Gas Consumption MJ/h	Water Supply kPa		Weight kg	Fittings			
		Min.	Max.		Hot	Cold	Gas	Condensate
REU-VRM3237WC	250	180	1000	29	R ¾ (20mm)	R ¾ (20mm)	R ¾ (20mm)	-
REU-VR3237WG	250	180	1000	29	R ¾ (20mm)	R ¾ (20mm)	R ¾ (20mm)	-
REU-VR2626WG	199	200	1000	16	R ¾ (20mm)	R ¾ (20mm)	R ¾ (20mm)	-
REU-VRM2630WD	199	190	1000	17	R ¾ (20mm)	R ¾ (20mm)	R ¾ (20mm)	-
REU-VRM2632WC	199	140	1000	21	R ¾ (20mm)	R ¾ (20mm)	R ¾ (20mm)	-
REU-VR2632FFUG	195	140	1000	21	R ¾ (20mm)	R ¾ (20mm)	R ¾ (20mm)	-
REU-VRM2632FFUC	195	140	1000	21	R ¾ (20mm)	R ¾ (20mm)	R ¾ (20mm)	-
REU-KM3237WD	211	250	1000	32	R ¾ (20mm)	R ¾ (20mm)	R ¾ (20mm)	R ½ (15mm)
REU-KM2635WD	172	250	1000	29	R ¾ (20mm)	R ¾ (20mm)	R ¾ (20mm)	R ½ (15mm)
REU-VR2426WB	188	200	1000	15	R ¾ (20mm)	R ¾ (20mm)	R ¾ (20mm)	-
REU-VR2024WG	160	160	1000	15	R ¾ (20mm)	R ¾ (20mm)	R ¾ (20mm)	-
REU-VR2024WB	160	160	1000	15	R ¾ (20mm)	R ¾ (20mm)	R ¾ (20mm)	-
REU-VR1620WG	125	120	1000	15	R ½ (15mm)	R ½ (15mm)	R ¾ (20mm)	-
REU-VR1620WB	125	120	1000	15	R ½ (15mm)	R ½ (15mm)	R ¾ (20mm)	-

Table 1.

GENERAL INSTALLATION INSTRUCTIONS

HORIZONTAL FLUE TERMINAL CLEARANCES

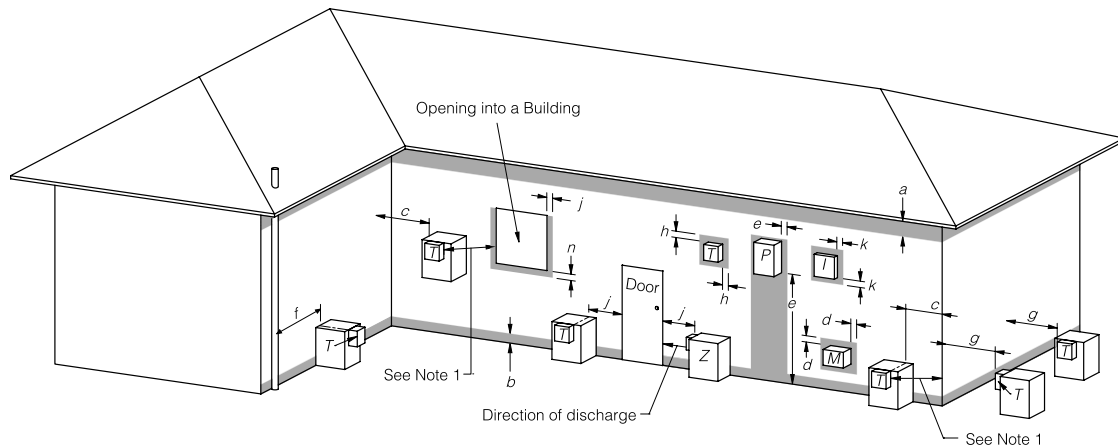

T = Flue terminal Z = Fan assisted flue appliance only M = Gas meter P = Electricity meter or fuse box I = Mechanical air inlet

■ Shading indicates prohibited areas for flue terminals

Ref.	Item	Min. clearances (mm)	
		Natural draft	Fan assisted
	Below eaves, balconies and other projections:		
a	• Appliances up to 50 MJ/h input	300	200
	• Appliances over 50 MJ/h input	500	300
b	From the ground, above a balcony or other surface *	300	300
c	Front a return wall or external corner *	500	300
d	From a gas meter (M) (see 5.11.5.9 for vent terminal location of regulator) (see Table 6.6 for New Zealand requirements)	1000	1000
e	From an electricity meter or fuse box (P) †	500	500
f	From a drain pipe or soil pipe	150	75
g	Horizontally from any building structure* = or obstruction facing a terminal	500	500
h	From any other flue terminal, cowl, or combustion air intake †	500	300
	Horizontally from an openable window, door, non-mechanical air inlet, or any other opening into a building with the exception of sub-floor ventilation:		
	• Appliances up to 150 MJ/h input *	500	300
j	• Appliances over 150 MJ/h input up to 200 MJ/h input *	1500	300
	• Appliances over 200 MJ/h input up to 250 MJ/h input *	1500	500
	• Appliances over 250 MJ/h input *	1500	1500
	• All fan-assisted flue appliances, in the direction of discharge	-	1500
k	From a mechanical air inlet, including a spa blower	1500	1000
	Vertically below an openable window, non-mechanical air inlet, or any other opening into a building with the exception of sub-floor ventilation:		
n	• Space heaters up to 50 MJ/hr input	150	150
	• Other appliances up to 50 MJ/hr input	500	500
	• Appliances over 50 MJ/h input and up to 150 MJ/h input	1000	1000
	• Appliances over 150 MJ/h input	1500	1500

* - unless appliance is certified for closer installation

† - Prohibited area below electricity meter or fuse box extends to ground level.

NOTES:

- 1 Where dimensions c, j or k cannot be achieved an equivalent horizontal distance measured diagonally from the nearest discharge point of the terminal to the opening may be deemed by the Technical Regulator to comply.
- 2 See Clause 6.9.4 for restrictions on a flue terminal under a covered area.
- 3 See Figure J3 for clearances required from a flue terminal to an LP Gas cylinder. A flue terminal is considered to be a source of ignition.
- 4 For appliances not addressed above acceptance should be obtained from the Technical Regulator.

FIGURE 6.2 (in-part) MINIMUM CLEARANCES REQUIRED FOR BALANCED FLUE TERMINALS, FAN-ASSISTED FLUE TERMINALS, ROOM-SEALED APPLIANCE TERMINALS AND OPENINGS OF OUTDOOR APPLIANCES

Extract from AS/NZS 5601

GENERAL INSTALLATION INSTRUCTIONS

HORIZONTAL OBSTRUCTIONS

AS/NZS 5601 'Gas Installations' stipulates a minimum horizontal clearance of 500 mm between a building structure and obstruction facing the terminal. For Rinnai external continuous flow water heaters such a building structure must 'obstruct' the full front cover height of the appliance, or extend vertically above and below the front cover. There must be no partial obstructions to the front cover of the appliance or any other parts of the appliance casing. This will avoid the appliance failing to operate under windy conditions.

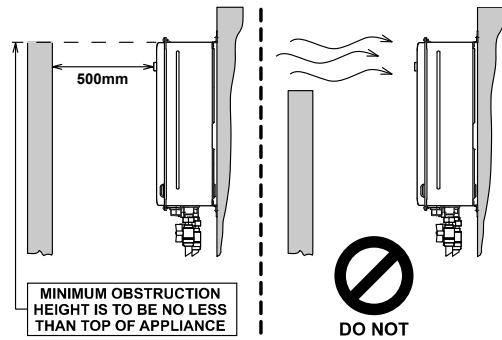

MULTIPLE INSTALLATIONS OF EXTERNAL MODELS

Dimension 'h' above does not apply when multiple Rinnai external water heaters of the same model are installed on the same vertical face with flue terminals at the same height. Under these conditions appliances can abut each other as shown. The total gas consumption of all appliances applies when determining other clearances.

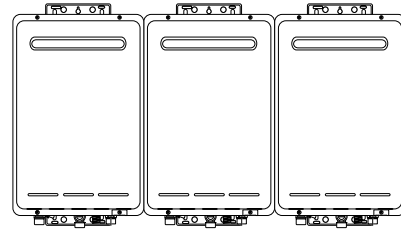

GENERAL INSTALLATION INSTRUCTIONS

APPLIANCE AND WATER CONTROLLER DIMENSIONS

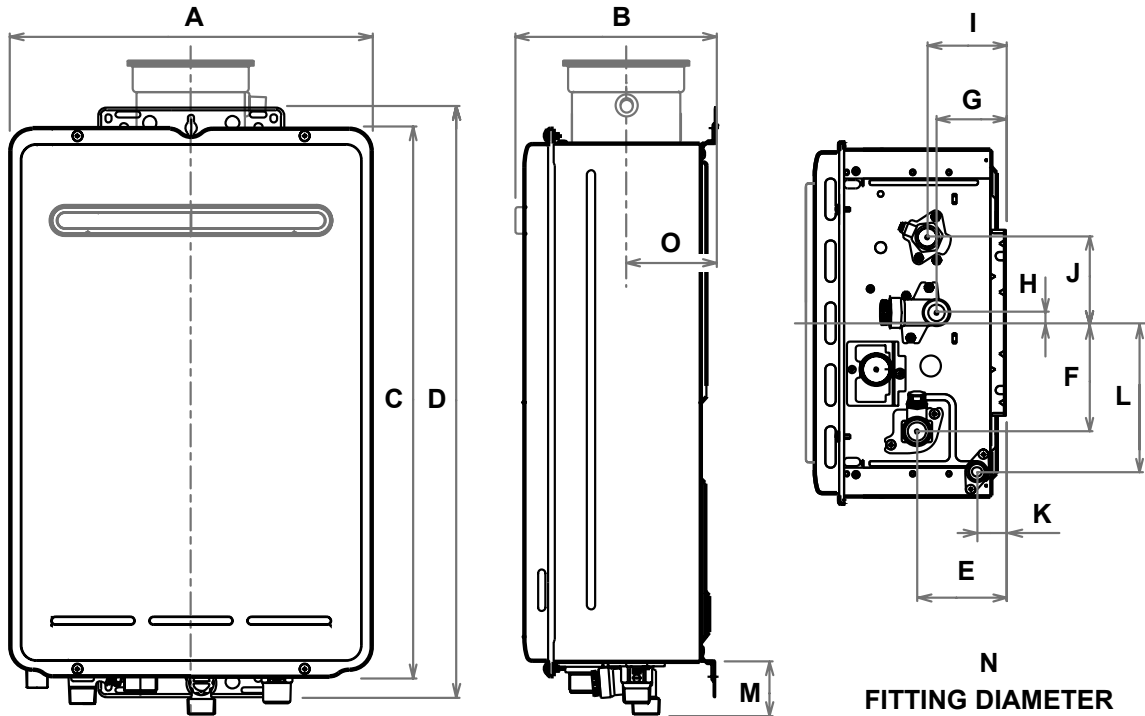

Dim'	Description	REU-VR3237WG REU-VRM3237WC	REU-VR2626WG	REU-VRM2630WD	REU-VR2632FFUG REU-VRM2632FFUC	REU-KM3237WD	REU-KM2635WD	REU-VR2426WB	REU-VR2024WG REU-VR2024WB	REU-VR1620WG REU-VR1620WB	REU-VRM2632WC
A	Width	470	350	355.6	350	470	470	350	350	350	350
B	Depth	244	194	202	235~275	283	283	194	194	194	251
C	Height - Unit	600	530	503	600	670	670	530	530	530	600
D	Height - Including Brackets	644	571	571	641	722	722	571	571	571	636
E	Hot Water outlet (from wall)	115	87	87	91 ~ 131	115	115	87	87	87	96
F	Hot Water outlet (from centre)	61	105	105	110	100	100	105	105	105	110
G	Cold Water inlet (from wall)	99	68	68	70 ~ 110	80	75	68	68	68	75
H	Cold Water inlet (from centre)	52	10	10	27*	28	13	10	10	10	27*
I	Gas Connection (from wall)	61	77	77	99 ~ 139	104	104	77	77	77	104
J	Gas Connection (from centre)	110	83	83	89	103	103	83	83	83	89
K	Condensate outlet (from wall)	-	-	-	-	138	138	-	-	-	-
L	Condensate outlet (from centre)	-	-	-	-	195	195	-	-	-	-
M	Gas Connection Length (from base)	41	40	40	41	40	40	40	40	40	41
	Cold Connection Length (from base)	51	50	50	51	50	50	50	50	50	51
	Hot Connection Length (from base)	42	42	42	42	41	41	42	39	39	42
	Condensate Connection Length (from base)	-	-	-	-	22	22	-	-	-	-
N	Gas: Fitting Diameter	20	20	20	20	20	20	20	20	20	20
	Cold: Fitting Diameter	20	20	20	20	20	20	20	20	15	20
	Hot: Fitting Diameter	20	20	20	20	20	20	20	20	15	20
	Condensate: Fitting Diameter	-	-	-	-	15	15	-	-	-	-
O	Flue Spigot Centreline (from wall, FFU only)	-	-	-	95 ~ 135	-	-	-	-	-	-

* Please note that this measurement is to the left of the centre line.

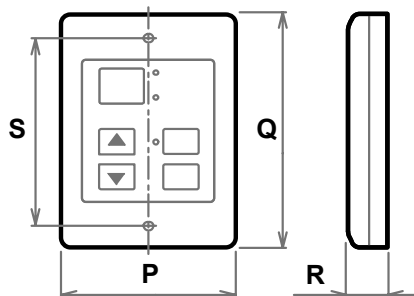

Dim'	Description	MC-91	MC-100V	BC-100V
P	Width	90	128	202
Q	Height	120	120	104
R	Depth	20	20	22
S	Distance between mounting hole centres	83	83	181

GENERAL INSTALLATION INSTRUCTIONS

CO-AXIAL FLUEING FOR INTERNAL MODELS

Rinnai internal models described in this manual must use the Co-Axial Rinnai FFU flue components. The use of non Rinnai FFU flue components may result in a dangerous situation and violates regulations.

The FFU flue system must be installed in accordance with the 'FFU Flue Installation Manual' which is provided with the FFU flue terminal components FFWALLTERM or FFROOFCOWL.

Installations can consist of both horizontal and vertical runs to a maximum length of 9 metres and with a maximum of three 90° bends.

If flue length exceeds 1.5m, dipswitch 1 of SW1 is to be switched to the 'OFF' position.

This increases the combustion speed to overcome the additional friction losses.

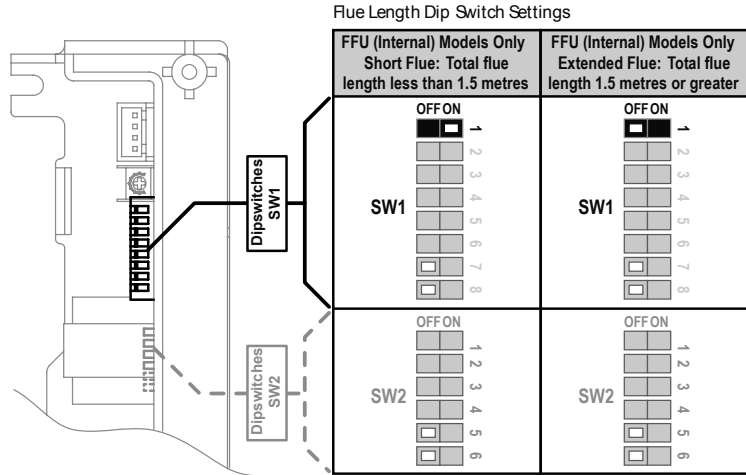

Basic methods of installation

There are four basic flue installation methods available. These are:

- (1.) Direct Horizontal
- (2.) Extended Horizontal
- (3.) Vertical
- (4.) Combination Vertical / Horizontal

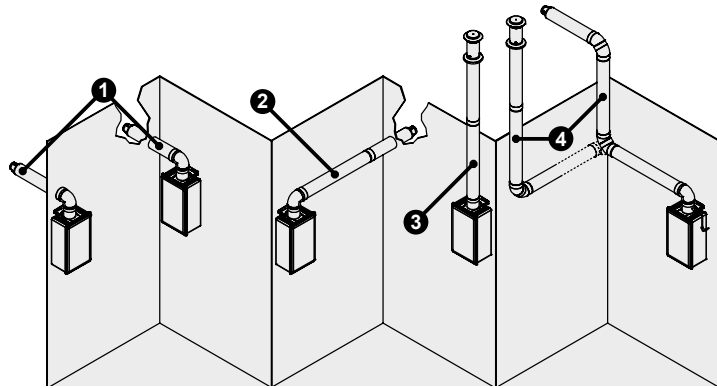

Multiple Terminal Installations

The terminal clearances stated in AS/NZS 5601 do not apply to the Rinnai internal continuous flow water heaters when they are installed side by side.

AGA certification allows for a horizontal separation of 160 mm for roof terminals and 270 mm for wall terminals.

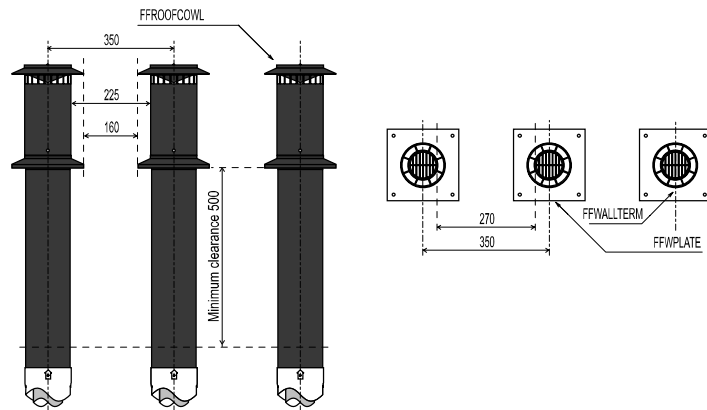

CONDENSATE DRAIN (REU-KM' MODELS ONLY)

The INFINITY ENVIRO range water heaters generate condensate continuously at a rate of up to 5 litres per hour as a by-product of highly efficient gas burner system. This condensate must be drained via a pipe to a suitable point of discharge. Because the condensate is a by-product of gas combustion it is mildly acidic. For this reason copper tube and fittings **MUST NOT** be used as it will corrode. Instead, Rinnai recommend plastic pipes and fittings such as Unplasticised Polyvinyl Chloride (UPVC) or Polyethylene (PE) which is commonly used for irrigation piping.

IMPORTANT CONSIDERATIONS FOR THE CONDENSATE DRAIN PIPE



The content of AS/NZS 3500 'Temperature / Pressure Relief and Expansion Control Valve Drain Lines' has been used as a guide in preparing these considerations.

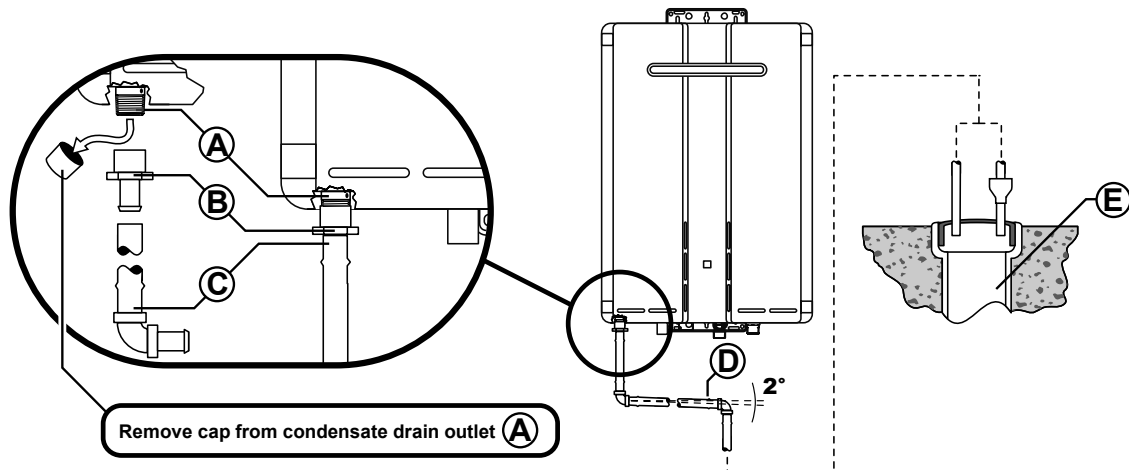

- (A) Water heater drain outlet connection, R $\frac{1}{2}$ " (15 mm) BSP male. Condensate drain outlet connection, 1/2" (15mm) BSP male nylon (**Note: the black plastic shipping cap MUST BE removed from the condensate drain outlet prior to water heater operation**).
- (B) PE R $\frac{1}{2}$ " BSP (15 mm) female to barbed irrigation system connector (13 – 19mm) or equivalent plastic fitting. (C) Drain pipe and fittings to match item (B).
- (D) Continuous fall (of at least 2°) from water heater to discharge point. Lengths and bends in accordance with '**LENGTH AND CHANGES OF DIRECTION**' below.
- (E) Suitable points of discharge are deemed to be drains, sewers or pits. **DO NOT** discharge onto electrical connections, earth stakes, copper pipes, concrete paths or into a pond.

LENGTH AND CHANGES OF DIRECTION

Maximum length and changes of direction greater than 45° should be as follows:

Lengths and changes of direction				
Max length (Metres)	9	8	7	6
Max changes of direction >45°	3	4	5	6

INSTALLATION

- (a) The drain line **MUST NOT** discharge onto electrical connections, earth stakes, copper pipes, concrete paths or into a pond.
 - (b) The point of discharge from each drain line shall be located so that the release of condensate does not cause a nuisance, is readily discernible and incurs no risk of damage to the building.
- In view of (a) and (b), suitable points of discharge are deemed to be drains, sewers or pits.
- (c) There shall be no tap, valve or other restrictions in any line.
 - (d) Each line shall fall continuously from the valve to the approved point of discharge.
 - (e) Drain lines shall not discharge into a storage water heater safe tray.
 - (f) The end of the condensate drain line shall be:
 - (i) not lower than 200 mm or higher than 300 mm above an unpaved surface; or
 - (ii) not lower than 75 mm or higher than 300 mm above a gravel pit not less than 100 mm in diameter in a paved surface.
 - (g) Where discharging over a tundish or gully trap, drain lines shall have an air gap of a size at least twice the diameter of the drain line.

CONDENSATE DRAIN (REU-KM' MODELS ONLY)

INTERCONNECTION OF CONDENSATE DRAIN LINES

Condensate drain lines from multiple water heaters may be joined together provided they conform with the '**INSTALLATION**' requirements on page 28.

COMMON STACK DISCHARGE

Where individual water heaters are installed in a multistorey building, the condensate drain lines may discharge into a common stack, subject to the following:

- (a) The discharge from the common stack is to a tundish, having a discharge line, that is not less than the size of the common stack, directly connected to a fixture trap, and installed in connection with any adjacent soil or waste stack.
- (b) The discharge point of the common stack is such that any discharge is readily visible and not cause any nuisance.
- (c) The common stack is vented by extending the pipe upwards, above the roof level.

TUNDISH DRAIN LINES

The drain line from any tundish shall be not less than DN 20 or less than one size larger than that of the largest drain line discharging into the tundish. Tundish drain lines shall comply with the '**INSTALLATION**' requirements on page 28.

AREAS SUBJECT TO FREEZING

In areas where water pipes are prone to freezing, the drain pipe from any valve shall be insulated and not exceed 300 mm in length. It shall discharge into a tundish through an air gap of not less than 75 mm and not more than 150 mm measured from the outlet of the drain pipe to the rim of the tundish.

WATER CONTROLLER INSTALLATION

RINNAI WATER CONTROLLERS

Water controllers are available as an optional extra. Universal and Deluxe water controllers can be used together and will function as described in the Operation Section of this manual. Please refer to page 7 to confirm the maximum number and combination of water controllers that can be fitted.



Other manufacturers water controllers are **NOT** compatible with Rinnai water heaters. Water controllers **MUST NOT** be used with any Solar Boost water heater. Rinnai water controllers brought in from other countries are not compatible with Rinnai appliances sold in Australia.

POSITIONING OF WATER CONTROLLERS

Water controllers must be installed in shaded and clean locations. They should be fitted out of reach of children (suggested height from floor to be at least 1500 mm). BC-100V remote controllers are water resistant, however, durability is improved when positioned outside the shower recess. All deluxe remote controllers must be installed at least 400 mm above the highest part of a sink, basin or bath.



- Do not install remote controllers near a heat source, such as a cook top, stove or oven. Heat, steam, smoke and hot oil may cause damage.
- Do not install remote controllers in direct sunlight.
- The MC-100V remote controller **MUST NOT** be installed in a bathroom.
- Do not install remote controllers outdoors unless protection from dust ingress and sunlight are provided.
- Do not install remote controllers against a metal wall unless the wall is earthed in accordance with AS/NZS3000.
- Water controllers **MUST NOT** be installed where chemicals such as benzine, alcohol, turpentine or other similar chemicals are in use.

POSITIONING CONSIDERATIONS FOR THE MC-100V WATER CONTROLLER.

The MC-100V uses a Liquid Crystal Display (LCD) for the digital monitor. Light reflections can make the LCD difficult to see at direct eye level.

For best results when installing the MC-100V mount the remote controller lower than your eye-level to avoid these light reflections.

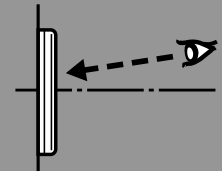

WATER CONTROLLER CABLES

Water controllers operate at extra low voltage (12 Volts DC) which is supplied from the water heater. Each Water controller comes supplied with 15 m of electrical cable. The appliance end of the cables are fitted with spade terminals. Extension cabling is available from Rinnai.



Alternatively two core sheathed (double insulated) flex with minimum cross-sectional area of 0.5 mm² may be used. Maximum individual cable runs should not exceed 50 m.

FITTING THE 'UNIVERSAL' WATER CONTROL (MC-91Q)

1. Determine the most suitable position for the water controller.
2. Mark and drill 3 holes, locating the cable access as shown in Fig. 1.
3. When running cable through the access hole ensure the connector end of the cable is located nearest to the controller (Fig.2).
4. Carefully remove face plate from the water controller, using a screw driver (Fig. 3).
5. Connect the cable to the water controller. Feed any excess cable lengths into the wall cavity to avoid the pinching of cables between the wall and the controller.
6. Fix the water controller to the wall using the appropriate fixings as shown in (Fig. 4).

WATER CONTROLLER INSTALLATION

7. Remove protective film from the water controller face as shown in Fig. 4 and replace face plate.

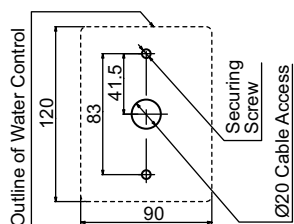

Fig. 1

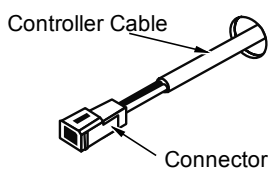

Fig. 2

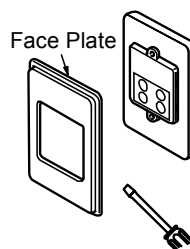

Fig. 3

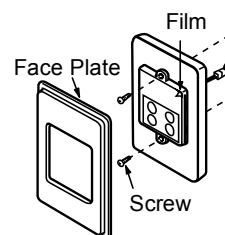

Fig. 4

OPTIONAL PROGRAMMING FOR THE 'UNIVERSAL' WATER CONTROLLER (MC-91Q)



1 Are there four water controllers connected?

IF NO: (You have three water controllers or fewer), go to Question 2.

IF YES: You will need to activate the fourth water controller as follows:

STEP 1: For the water controller in the KITCHEN ONLY, press and hold the 'Transfer' and 'On/Off' buttons simultaneously (see Fig. 5) until a 'beep' is heard (approximately 5 seconds).

STEP 2: Check that the display on ALL FOUR water controllers is lit and displaying a temperature when 'switched on'. If any ONE of the controller displays two dashes (see Fig. 6) repeat STEP 1.

This completes the activation procedure for the fourth controller, you may ignore Question 2.

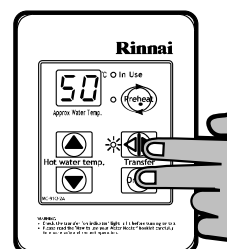

Fig. 5



Fig. 6



2 Is the water heater marked to state it delivers water not exceeding 50°C?

IF YES: No further action required.

IF NO: You will need to program the kitchen controller to enable selection of temperatures higher than 50°C.

STEP 1: For the controller in the KITCHEN ONLY, press and hold the 'Transfer' and 'On/Off' buttons simultaneously (Fig. 7) until a 'beep' is heard (approximately 5 seconds).

STEP 2: When the controller fitted in the KITCHEN is switched On, it should be possible to select temperatures higher than 50°C. If not, repeat STEP 1.

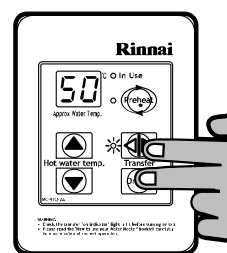

Fig. 7



If the water controller in the kitchen is replaced, repeat STEP 1 above for the replacement controller.

If the water controller in the kitchen is swapped with another controller (for example, the controller fitted in a bathroom), repeat STEP 1 for the controller moved from the kitchen to the bathroom. Then perform STEP 1 for the controller moved from bathroom to the kitchen.

WATER CONTROLLER INSTALLATION

FITTING THE 'DELUXE KITCHEN' WATER CONTROLLER (MC-100V)

1. Determine the most suitable position for the water controller (see notes page 30).
2. Use the wall mounting bracket as a template to mark and drill 3 holes, locating the cable access as shown in Fig. 1.
3. Fix the mounting bracket to the wall using the appropriate fixings.
4. Run the cable through the hole in the wall.
5. Carefully remove face plate from the water controller, using a screw driver (Fig. 2).

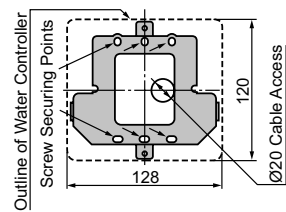

Fig.1

6. Connect the cable to the water controller as shown in Fig 3. At this point cables from other controllers (if fitted) may also be connected to the screw terminals of the Kitchen water controller (Fig. 4) eliminating the need for multiple cable runs directly to the water heater. Water controllers are not polarity sensitive. Feed any excess cable lengths into the wall cavity to avoid the pinching of cables between the wall and the controller.
7. Fasten the controller to the wall mounting bracket as shown in Fig. 5. Avoid the over-tightening of fixings as this may cause damage. Once secured replace the face plate.

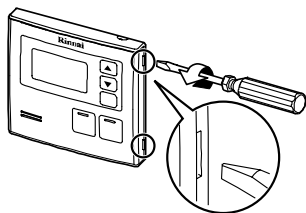

Fig. 2

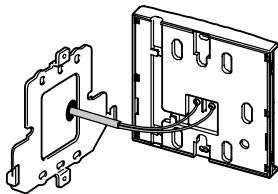

Fig. 3

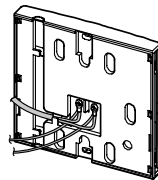

Fig. 4

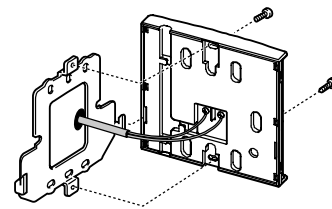

Fig. 5

FITTING THE 'DELUXE BATHROOM' WATER CONTROLLER (BC-100V)

1. Determine the most suitable position for the water controller (see notes page 30).
2. Mark and drill 3 holes, locating the cable access as shown in Fig. 1.
3. When running a cable through the access hole ensure the connector end of the cable is located nearest to the controller (Fig. 2).
4. Affix the double sided self-adhesive seal to the back of the water controller (Fig. 3).

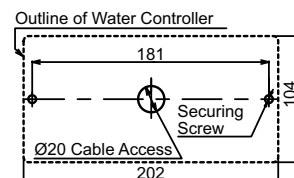

Fig. 1

5. Carefully remove the face plate from the water controller, do this by placing your thumbs on the front of the digital display and while hooking your fingers behind top of plate and gently push as shown in Fig. 4, DO NOT use a screwdriver as this may damage the controller.
6. Connect the cable to the water controller. Feed any excess cable lengths into the wall cavity to avoid the pinching of cables between the wall and the controller.

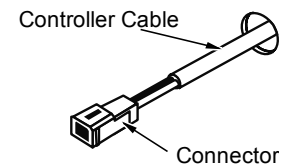

Fig. 2

7. Fix the controller to the wall using the appropriate fixings as shown in Fig. 5, avoid over-tightening of fixings as this may cause damage. Once secured replace the face plate.

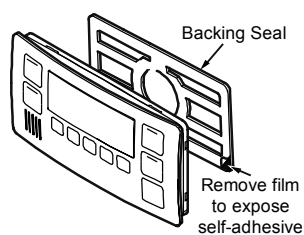

Fig. 3

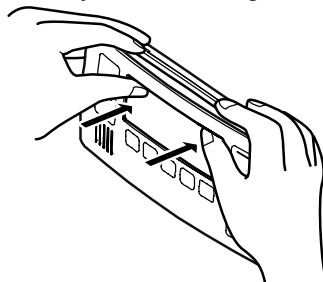

Fig. 4

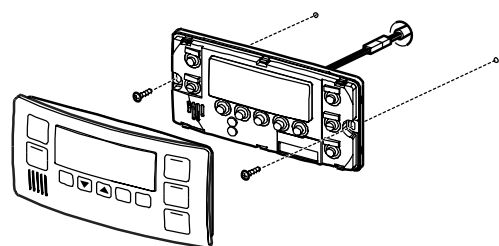

Fig. 5

WATER CONTROLLER INSTALLATION

CONNECTING COMMUNICATION CABLES TO THE WATER HEATER

Communication cables connect the water heater to water controllers and operate at an extra low voltage (12 Volts DC) which is supplied from the water heater. Communication cables are supplied with the water controllers (15m) and are fitted with spade terminals for connection to water heater. Up to two cables can be connected directly to the 'Ezi connect' cable connector at the water heater. Extension cables are available from Rinnai. Alternatively, two core sheathed (double insulated) flex with minimum cross sectional area of 0.5mm² may be used. Cable lengths must not exceed 20 metres.



DO NOT attempt to connect cables to the 'Ezi connect' cable connector at the water heater unless the electric power to the water heater is switched 'off' otherwise damage to electrical components may occur.

To connect up to two cables to the 'Ezi connect' cable connector

1. Isolate the electric power supply by switching the power point off and removing the power plug of the water heater from the electric power socket.
2. Remove the retaining screw **(A)** of the 'Ezi connect' cable connector at the base of the appliance.
3. Swing the 'Ezi connect' cable connector door open and thread the cable through the weather seal of the cable access hole **(B)** in the direction shown allowing sufficient cable length so that the sheath of the cable can be secured with cable clamp **(C)** supplied with the transceiver.
4. Loosen screw terminals **(D)** & **(E)** and connect the cable spade connectors to these terminals and re-tighten. Polarity is not important, either wire colour can be connected to either terminal.
5. Return the 'Ezi connect' cable connector to the original position taking care not to damage cable wires in the process and replace the retaining screw **(A)**.

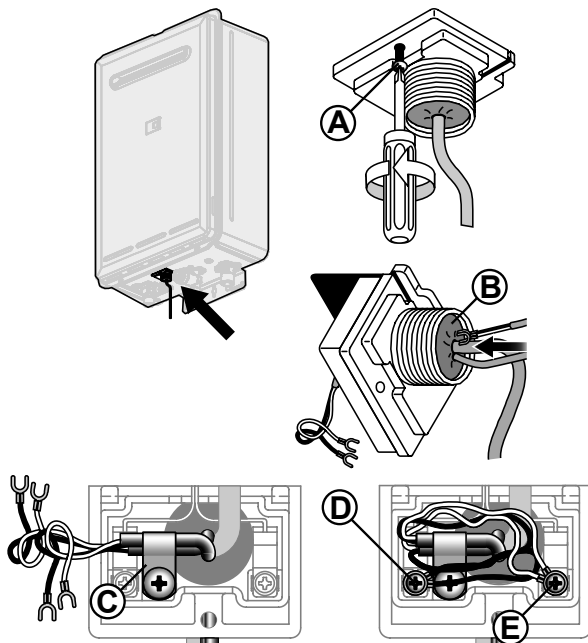

'Ezi connect' cable connector for water heater models:
INFINITY 26, 26 Plus, 20, 16, V1500, V1200.
HD 200e (REU-VM2630WC).

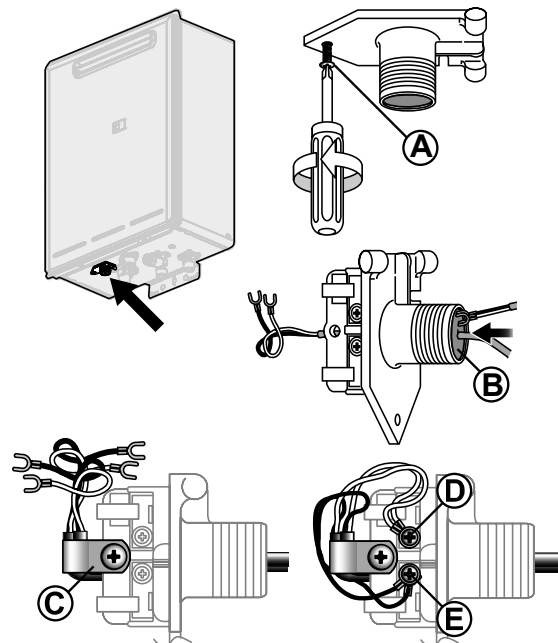

'Ezi connect' cable connector for water heater models:
INFINITY 32, 26i, EVIROSMART
HD 250e, 200e (REU-VRM2632WC), 200i

Connecting Three or Four Controllers

Repeat steps 1, 2 and 3 above.

To connect three or four cables, separate all the cables to be fitted into pairs. Cut off the existing spade connectors from each pair and re-terminate each pair into a new spade connector (available from your local electrical component retailer) **(F)** so that there are only two sets of spade connectors (4 spade connectors in total) to be terminated.

Repeat steps 4 and 5 above.

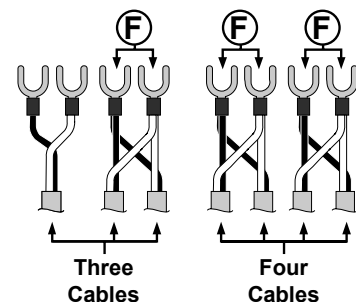

COMMISSIONING

TESTING

1. Before final connection of the water heater purge gas, hot water and cold water supply lines. Swarf in either the gas or water supplies may cause damage.
2. Turn on gas and cold water supplies.
3. Test for water leaks and gas escapes near the unit.
4. Isolate gas supply. Remove test point screw located on the gas inlet connection and attach pressure gauge.
5. Turn the power 'on' at the power point socket and turn on gas.
6. If water controllers are fitted, ensure that the controllers are 'ON', select the maximum delivery temperature and open ALL available hot water taps including the shower. If remote controllers are not fitted, simply open all available hot water taps. (CAUTION: Ensure building occupants do not have access to hot water outlets during this procedure.)
7. Operate ALL other gas appliances at their maximum gas rate, in accordance with manufacturers instructions.
8. With all gas appliances in operation at maximum gas rate, the pressure should read between 1.13 - 3.0 kPa on Natural Gas. On LPG the pressure should be 2.75 - 3.0 kPa. If the pressure is lower, the gas supply is inadequate and the appliance will not operate to specification. It is the Installers responsibility to check the gas meter, service regulator and pipe work for correct operation/sizing and rectify as required. Note that the gas regulator on the appliance is electronically controlled and factory pre-set. Under normal circumstances it DOES NOT need adjustment during installation.
9. Close hot water taps including the shower.
10. Inspect and clean the strainer located on the cold water inlet connection. This procedure may need to be repeated to ensure the strainer remains clear, especially on new installations.
11. If water controllers are fitted, it is necessary to test their operation through the complete range of functions (refer to the Operation sections of this manual).
12. Confirm the hot water delivery temperature(s) using a thermometer. If controllers are fitted, ensure temperatures exceeding 50°C cannot be selected on bathroom or ensuite controllers. Refer to the section 'Delivery Temperature' below for more details.
13. After testing is completed, explain to the householder the functions and operation of the water heater and temperature controllers (if fitted). Ensure the "PRODUCT RECORDS" on page 36 of this manual is filled in and that the booklet is handed to the customer. Reminding the customer to complete the Warranty Card and forward to Rinnai.

DELIVERY TEMPERATURE

"50°C Compliant" appliances are 'factory set' to deliver a maximum temperature not exceeding 50°C. However, they have an incremental adjustment mechanism that allows the installer to increase the appliance delivery temperature incrementally from the 'Factory Set' value to temperatures exceeding 50°C. This is intended to enable compensation for temperature losses in the pipe-work between the water heater and any outlets and achieve the required temperature at the outlet. Instructions for incremental temperature adjustment are located in the instruction pocket inside the appliance front cover.

For "Solar" appliances (labelled S20, S26 or "Solar" on the front cover)

To meet regulatory requirements, the delivery temperature is factory set and sealed. This setting cannot be altered.

For all other models

Rinnai continuous flow water heaters are factory pre-set to various maximum delivery temperatures depending on model and their intended application. For the majority of applications, the factory pre-set temperature is appropriate. In the unlikely event it is not this setting can be increased or decreased by the installer. Instructions for changing the maximum delivery temperature are located in the instruction pocket inside the appliance front cover.

COMMISSIONING

GAS PRESSURE SETTING

The regulator is electronically controlled and factory pre-set. Under normal circumstances it does not require adjustment during installation.

Make adjustments only if the unit is not operating correctly and all other possible causes for incorrect operation have been eliminated.

Instructions for Gas Pressure Setting are to be found in the instruction pocket located inside the appliance front cover.

COMMISSIONING CHECK LIST

A commissioning check list is provided on the appliance front cover to enable the installer to step through the correct commissioning procedure when installing a Rinnai Continuous Flow water heater.

The check list can also assist the installer to identify potential installation errors that may prevent the appliance from operating correctly.

ACCESSORIES

Recess Box:

These allow the appliance to be recessed into the cavity of the wall saving precious space. Suitable for painting.

Pipe Cover:

These hide the plumbing pipe-work and valves underneath the appliance. Two pipe covers can be joined together for longer pipe-work.

Security Cage:

Protect the gas booster unit from theft and damage.

Security Bracket:

Prevent theft of the gas booster by securing it with the custom security bracket.

Sideways Flue Diverter

Designed to redirect flue products when the gas booster is installed on a balcony.

Contact Rinnai for further information about our accessory range and model suitability details.

PRODUCT RECORDS

Please take a moment to record the following information below for your own records.

Model No:	REU- _____	Serial No:	_____
Your Retailer:	_____		
Address:	_____		
Contact Number:	() _____		
Purchase Date :	_____ / / _____		
Your Installer :	_____		
Address :	_____		
Installers License No. :	_____		
Contact Number :	() _____		
Installation Date :	_____ / / _____		
Certificate of Compliance No. :	_____		

Rinnai

Rinnai Australia Pty. Ltd. ABN 74 005 138 769

Head Office

10-11 Walker Street,
Braeside, Victoria 3195
P.O. Box 460
Tel: (03) 9271 6625
Fax: (03) 9271 6622

Rinnai has a Service and Spare Parts network with personnel who are fully trained and equipped to give the best service on your Rinnai appliance. If your appliance requires service, please call our National Help Line. Rinnai recommends that this appliance be serviced every 3 years.

Internet: www.rinnai.com.au E-mail: enquiry@rinnai.com.au

National Help Line

Tel: 1300 555 545* Fax: 1300 555 655*

**Cost of a local call higher from mobile or public phones.*

Hot Water Service Line

Tel: 1800 000 340

U298-925(01)



060 00012 37647 0

Printed in Japan 2012.10