

SWT7055LMWA
SWT7055TMWA
SWT6555TMWA
SWT6055TMWA

REGISTER YOUR TOP LOAD WASHING MACHINE WITH YOUR SMARTPHONE

- 1 Locate the label on the back of the top control panel

Easy register with your smartphone

1. Photograph the camera icon, including the 4 dots (⊙)

2. Then text it to **0488 446 622** (Australia only)



- 2 Photograph the camera icon, including the 4 dots (⊙)
- 3 Text to 0488 446 622 (Australia only)

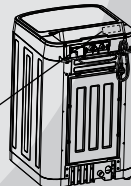

CONTENTS

1. SAFETY INFORMATION	2
2. PRODUCT DESCRIPTION	5
3. CONTROL PANEL	7
4. WASHING INSTRUCTIONS	14
5. DAILY USE	16
6. CARING FOR YOUR WASHING MACHINE	20
7. HELPFUL HINTS IN DEALING WITH WASHING PROBLEMS	23
8. A GUIDE TO STAIN REMOVAL	25
9. TROUBLE SHOOTING	27
10. ENVIRONMENT CONCERNS	30
11. WARRANTY	31

Important Information that may impact your Manufacturer's Warranty

Adherence to the directions for use in this manual is extremely important for health and safety. Failure to strictly adhere to the requirements in this manual may result in personal injury, property damage and affect your ability to make a claim under the Electrolux manufacturer's warranty provided with your product. Products must be used, installed and operated in accordance with this manual. You may not be able to claim on the Electrolux manufacturer's warranty in the event that your product fault is due to failure to adhere to this manual.

CUSTOMER CARE AND SERVICE

We recommend the use of original spare parts.

When contacting Service, ensure that you have the following data available.

The information can be found on the rating plate. Model, PNC, Serial Number.

 Warning / Caution-Safety information.

 General information and tips.

 Environmental information.

Subject to change without notice.

1. SAFETY INFORMATION

CONDITIONS OF USE

- This appliance is intended to be used in household and similar applications such as:
 - Farm houses
 - By clients in serviced apartments, holiday apartments and residential type environments.
- In the interest of your safety and to ensure the correct use, before installing and first using the appliance, read this user manual carefully, including its hints and warnings.
- To avoid unnecessary mistakes and accidents, it is important to ensure that all people using the appliance are thoroughly familiar with its operation and safety features.
- Save these instructions and make sure that they remain with the appliance if it is moved or sold, so that everyone using it through its life will be properly informed on appliance use and safety.
- new hose-sets supplied with the appliance are to be used and that old hose-sets should not be reused.

1.1 GENERAL SAFETY

- It is dangerous to alter the specifications or attempt to modify this product in anyway.

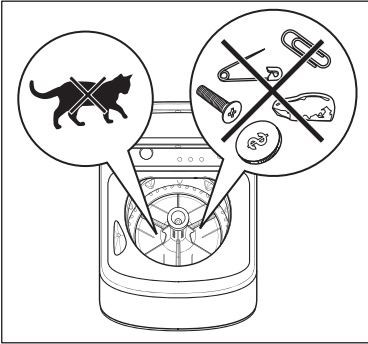

- Make sure that small pets do not climb into the washbowl. To avoid this, please check into the washbowl before using the appliance.
- Any objects such as coins, safety pins, nails, screws, stones or any other hard, sharp material can cause extensive damage and must not be placed into the machine.
- Only use the advised quantities of fabric softener and detergent. Damage to the fabric can ensue if you overfill. Refer to the manufacturer's recommendations of quantities.
- This appliance is not intended for use by persons (including children) with reduced physical, sensory or mental capabilities, or lack of experience and knowledge, unless they have been given supervision or instruction concerning use of the appliance by a person responsible for their safety.
- Wash small items such as socks, laces, washable belts etc in a washing bag or pillow case as it is possible for such items to slip down between the tub and the agitator.

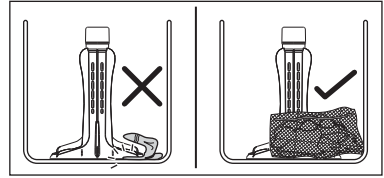

- Do not use your washing machine to wash articles with whale bones, material without hems or torn material.
- Always unplug the appliance and turn off the water supply after use, clean and maintenance.
- Under no circumstances should you attempt to repair the machine yourself. Repairs carried out by inexperienced persons may cause injury or serious malfunctioning. Contact your local Service Centre. Always insist on genuine spare parts.
- If the supply cord is damaged, should the appliance power supply cable need to be replaced, this shall be carried out by our Service Centre.

1.2 INSTALLATION

- When unpacking the appliance, check that it is not damaged. If in doubt, do not use it and contact the Service Centre.
- Appliance should not be installed in a humid place.
- After having installed the appliance, check that it is not standing on the inlet and drain hose.
- If the machine is situated on a carpeted floor, please adjust the feet in order to allow air to circulate freely.
- Always be sure, that there is no water leakage from hoses and their connections after the installation.

- Any plumbing work required to install this appliance should be carried out by a qualified plumber.
- Any electrical work required to install this appliance should be carried out by a qualified electrician.
-  Connect the machine to an earthed socket outlet.
- If this appliance is supplied from a cord extension set or electrical portable outlet device, the cord extension set or electrical portable device must be positioned so that it is not subject to splashing or ingress of moisture.
- Water pressures between minimum 50kPa and maximum 800kPa are acceptable.

1.3 USE

- This appliance is designed for domestic use. It must not be used for purposes other than those for which it was designed.
- Only wash fabrics which are designed to be machine washed. Follow the instructions on each garment label.
- Do not overload the appliance. See the relevant section in the user manual.
- Before washing, ensure that all pockets are empty and buttons and zips are fastened. Avoid washing frayed or torn articles and treat stains such as paint, ink, rust, and grass before washing.
- Garments which have been in contact with volatile petroleum products should not be machine washed. If volatile cleaning fluids are used, care should be taken to ensure that the fluid is removed from the garment before placing in the machine.

- Never pull the power supply cable to remove the plug from the socket, always take hold of the plug itself.

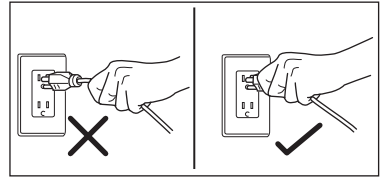

- Never use the washing machine if the power supply cable, the control panel, the working surface or the base are damaged so that the inside of the washing machine is accessible.



For safety reasons do not use double adaptors, extension cords and multi-plug adapters.

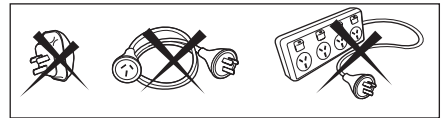

1.4 CHILD SAFETY

- This washing machine is not intended for use by young children or infirm persons without supervision.
- Young children should be supervised to ensure that they do not play with the appliance.
- The packaging components (e.g. plastic film, polystyrene) can be dangerous to children - danger of suffocation! Keep them out of children's reach.
- Keep all detergents in a safe place out of children's reach.
- Make sure that children or pets do not climb into the washbowl.

2. PRODUCT DESCRIPTION

2.1 WASHING MACHINE PARTS

FRONT VIEW

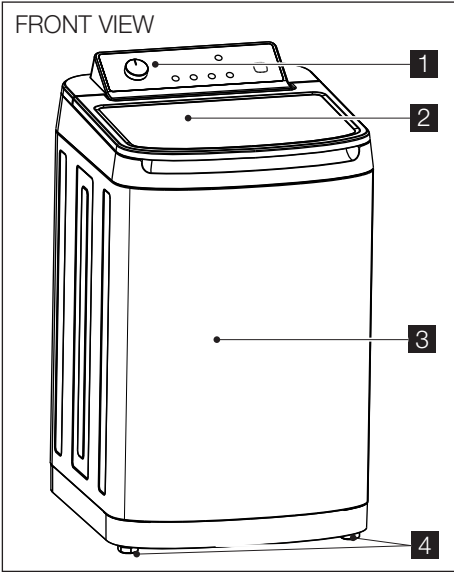

BACK VIEW

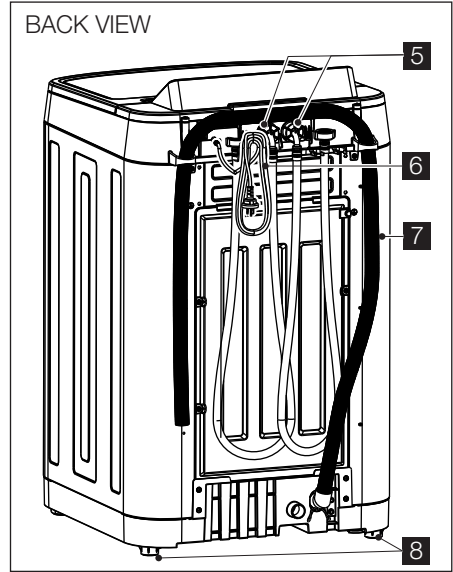
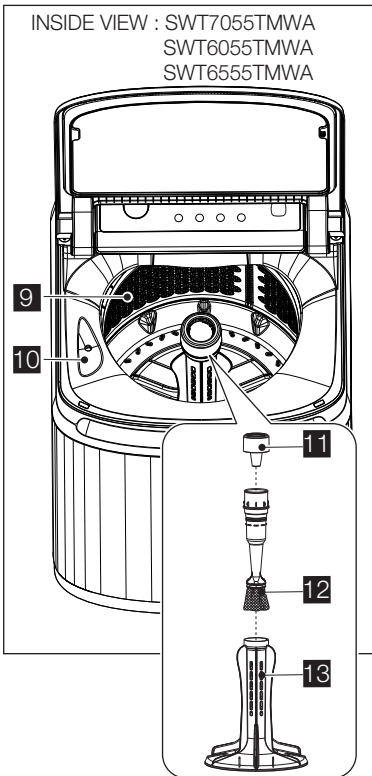
INSIDE VIEW : SWT7055TMWA
SWT6055TMWA
SWT6555TMWA

PARTS LIST

- | | | | |
|-----------|---|-----------|----------------------|
| 1 | Control Panel | | |
| 2 | Lid | | |
| 3 | Cabinet | | |
| 4 | Levelling Adjustable Front Feet | | |
| 5 | Water Inlet Hose
- RED fittings (Hot Water)
- BLUE fittings (Cold Water) | | |
| 6 | Mains Cable | | |
| 7 | Outlet Hose/
Drain Hose (See installation instructions sheet to fit & position drain hose) | | |
| 8 | Back Feet (fixed) | | |
| 9 | Wash Bowl | | |
| 10 | Bleach Dispenser | | |
| 11 | Fabric Softener Dispenser | | |
| 12 | Lint Filter | 14 | Low profile agitator |
| 13 | Agitator | 15 | Softener Drawer |
| | | 16 | Magnet |

INSIDE VIEW : SWT7055LMWA

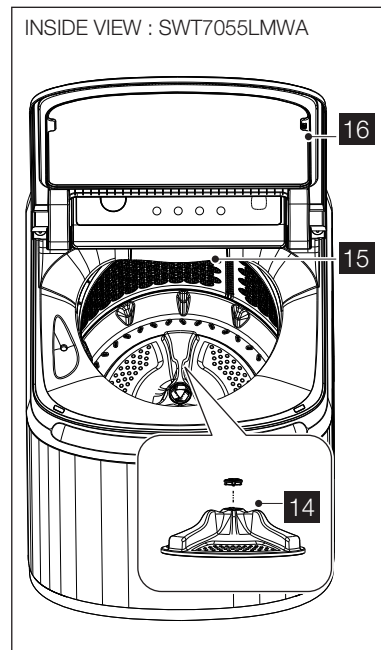

2.2 PRODUCT FEATURES

The Simpson wash system

1) Wash operation

The agitator & bowl rotates while it is filled with water to immerse the clothes.

The agitator then rotate to move the clothes so that the detergent can be dissolved and activated at the selected water temperature.

2) Agitation and dilution

After the wash operation is completed, the bowl is filled with more water. The agitator then moves in an energy efficient mode, generating additional mechanical actions.

Power Failure Recovery

When there is power failure while machine is washing or rinsing or spinning. The machine tries to save the settings at which stage the machine is doing and then when the power returns back the machine will starts washing from the stage where it is left off.

Button Response and Lights

Always press buttons gently. Watch the lights on the control panel to see the effect pressing a button or turning a program selector knob has, and listen for "BEEPS".

When you press a button you will get a short "BEEP" to acknowledge the entry. If the option is not available at the time, the machine will not allow you to select it, and you will here the three short "BEEP" to remind you the option is not available and the display will show " --- " and flashing.

After the machine has started, the entire wash option button will be disabled and the display will show " --- " and flashing with three short beeps to indicate the button is disabled (except Start/Pause button).



All functions of the washing machine will stop when the lid is open.

Enabling/Disabling End-of-Wash Beeping Mode (SWT7055TMWA / SWT7055LWA/SWT6055TMWA)

This mode permits you to either enable or disable the beeping at the end of the wash. As an example, you might wish to disable this beeping when you start a wash before going to bed, so that when the wash finished, it will not disturb you through the night. (Default is BEEP on)

To change the "beeping" selection, proceed as follows:

- If you wish to disable end of wash beeping, switch the machine ON and wait for 7 seconds then press Rinse option and Time adjust buttons simultaneously until you hear 2 beeps. Display will then show "bOF". To enable again follow the steps above until display shows "bOn".



NOTE:

- All error beeping is not disabled by this feature, such as a critical fault, or lid open during fill/agitatespin, or out of balance during spinning.
- Responding sound while pressing the button is not disabled by this feature.

3. CONTROL PANEL

SWT7055LMWA / SWT7055TMWA
/ SWT6055TMWA

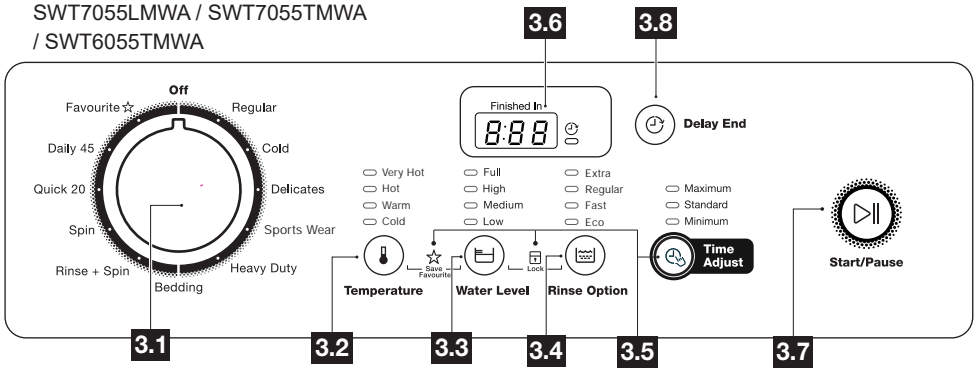

SWT6555TMWA

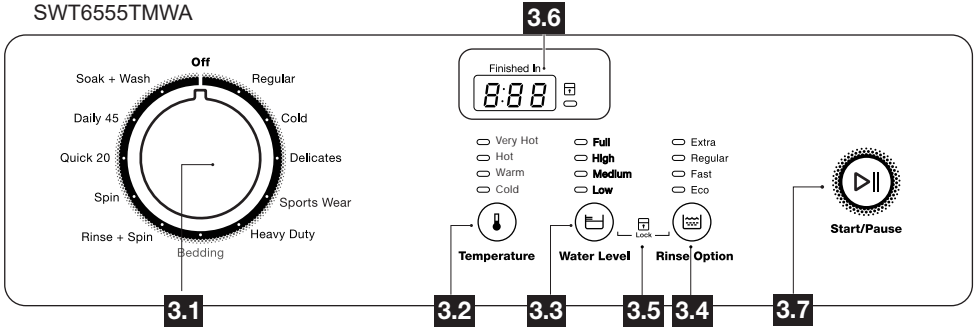

3.1 PROGRAM SELECTOR KNOB

Turn the Program Selector knob to choose the wash program you want. The table “Your Program Guide” shown on page 13 will help you in selecting the right program.

The Program Selector knob is not a timer. Once you select a wash program, the Program Selector knob will stay at that position for the whole wash cycle.

3.2 WATER TEMPERATURES BUTTON

For each wash program your washing machine automatically selects a suitable fill water temperature. If you want to use a different wash water temperature, press the Temperature button repeatedly.

The water temp lights will tell you the temperature for each press of the button.

You have four temperatures to choose from Very hot, Hot, Warm, and Cold.

The temperature of warm water will depend on the temperature and pressure of your hot and cold water supplies. The recommended temperature for warm is 35°C.

You can adjust the flow rate of the water supplies to adjust the Warm temperature. All rinse water temperatures are cold.

Always check your label for the washing temperature symbols which the International Care Labelling Code now uses



i NOTE:

If you have a cold water connection ONLY and the hot inlet valve is capped off (refer installation instructions) you must select Cold washes only. To fill detergent, you must follow steps as below:

1. Measure the correct amount of powder detergent by following the recommendations on the package.
2. Mix powder detergent in one litre of hot or warm water.
3. Add the pre-mixed detergent to the wash load.

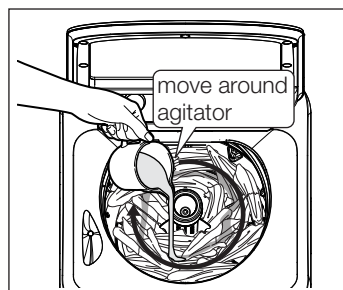

NOTE :

SWT7055LMWA use low profile agitator on page 5

Proportion of Hot and Cold water based on temperature selection.

Temp.	Descriptions	Water from HOT valve	Water from COLD valve
Very hot	for normally soiled white cottons and linen (e.g. teacloths, towels, tablecloths, sheets...).	100 %	0 %
Hot	for normally soiled, colourfast garments (e.g. shirts, night dresses, pyjamas....) in linen, cotton or synthetic fibres and for lightly soiled white cotton (e.g.underwear).	65 %	35 %
Warm	for delicate items (e.g. net curtains), mixed laundry including synthetic fibres and	50 %	50 %
Cold	woollens bearing the label pure new wool, machine washable, non-shrink.	10 %	90 %

IMPORTANT: Components in the washing machine are designed to be used with water no hotter than 70°C. If your water supply is too hot, you should have a temperature limiting valve fitted by a qualified plumber.



Flood diagnostic is explained on page 27. You should refer to this if you have water pouring onto the floor. The display will show “E30” and you will hear rapid short beep continuously to remind you about this problem.

3.3 WATER LEVEL BUTTON

Choose the water level by pressing Water Level button. Use only the amount of water you need for the wash load.

CHOOSE THE WATER LEVEL

Water Level	Appropriate Clothes Load (kg)	
	Model SWT6055TMWA	Model SWT6555TMWA SWT7055LMWA SWT7055TMWA
Full	4 to 6.0	5 to 7
High	3 to 4.5	3 to 5
Medium	1.5 to 3	1.5 to 3
Low	0 to 1.5	0 to 1.5

1. Choose the water level by pressing Water Level button.

You can select:

• **Full, High, Medium and Low**

2. Use only the amount of water you need for the wash load.

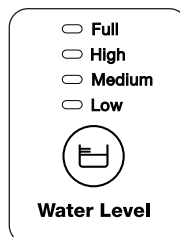

- 1) Model SWT6055TMWA Maximum mass of dry cloth is 6.0 kg.
- 2) Model SWT6555TMWA Maximum mass of dry cloth is 6.5 kg.
- 3) Model SWT7055LMWA Maximum mass of dry cloth is 7.0 kg.
- 4) Model SWT7055TMWA Maximum mass of dry cloth is 7.0 kg.

3.4 RINSE OPTION BUTTON

Pressing the Rinse Option button to choose the rinse type for your wash load. For most washes the machine automatically selects “Regular” rinse for you.

There are four rinses to choose from Extra, Regular, Fast and Eco.

- **Extra rinse**, the machine fills twice, giving you two deep rinses.
- **Regular rinse**, the machine fills once, giving you one regular rinse.
- **Fast Rinse**, Fast rinse uses less time than Eco rinse by performing only 3 Eco sprays but the amount of water in each spray is increased.
- **Eco rinse**, is a spray rinse giving you maximum water saving.

i After cycle has finished, You must drain the water from the washing tub by pressing “Start/Pause” button to continue the cycle.

How does Eco Rinse work ?

When Eco rinse is used, rinse water is sprayed into the washbowl in pulses. After each pulse the washbowl will spin to remove detergent laden water from the clothes.

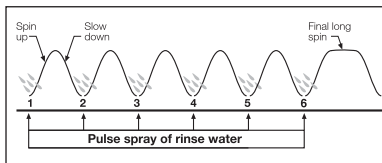

The machine will go through a series of maximum six pulses spray and short spin cycles in this manner, depending on program selection, followed by a final long spin that removes the water from the clothes to complete the full wash program.

i NOTE:

- Compare this with Regular rinse where much more water is used.
- Regular rinse, water enters the machine filling up to the wash water level selected. The washer agitates and finally empties the rinse water through the drain hose.
- Extra rinse, this is special option for those people who suffer from allergies, this extra rinse will provide two Regular rinses to ensure all detergent residue has been removed.
- Eco Rinse and Fast Rinse **CANNOT** be selected with Bedding program.
- **We strongly recommend** you use Eco rinse for your washes whenever you can. There is considerable saving of water when Eco is used instead of Regular or Extra to rinse clothes.
- **Eco and Fast rinse is not designed to be used with fabric softener.** Select **Regular** or **Extra** rinse if you are going to use fabric softener. Regular rinse ensures the fabric softener is correctly dispensed and thoroughly removed from your clothes during rinsing.
- Daily 45 program rinse is fixed with Regular rinse only
- Quick20 program rinse is fixed with Fast rinse only

3.5 TIME ADJUST, FAVOURITE , CHILD LOCK

TIME ADJUST

(SWT7055TMWA / SWT7055LMWA / SWT6055TMWA)

This option allows you to increase/decrease washing time from 3 available options. (Default is “Standard”)

: Standard > Minimum > Maximum

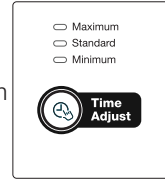

Time adjust is only applicable to

: Regular, Cold, Delicates, Hand Wash, Heavy Duty, Bedding

FAVOURITE

(SWT7055TMWA / SWT7055LMWA / SWT6055TMWA)

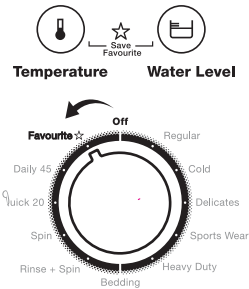

Selector Knob

The favourite function is the ability to tailor individual wash features and save them as a custom programme until the next time.

To save Favourite, select a wash program, Spin, Temperature, Rinse then press and hold Temperature and Water Level buttons simultaneously for > 2 seconds. Buzzer will sound then display will show "FAV". The program is now stored for later use by selecting Favourite via selector knob.

CHILD LOCK

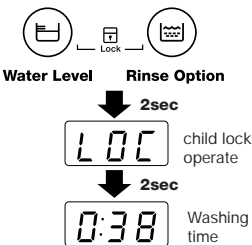

Your appliance is provided with CHILD SAFETY LOCK which permits you to leave the appliance unsupervised with the door closed without having to worry that children might be injured by or cause damage to the appliance.

To Activate the child lock :

: Hold down the “Water Level” and “Rinse Option” buttons at the same time for 2 seconds.

when activated buzzer will sound then display will show "LOC" for 2 seconds before going back to standby mode showing wash time.

(Model SWT6555TMWA display shows "LOC" and  icon will turn on)



To Deactivate the child lock :

: Hold down the “Water Level” and “Rinse Option” buttons at the same time for 2 seconds.

When deactivated buzzer will sound then display will show "unL" for 2 seconds then going back to show washing time.

(Model SWT6555TMWA display shows "unL" and  icon will turn off)



3.6 DISPLAY

The display shows the following information:

Machine In Pause Mode

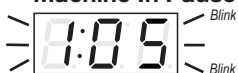

Time digits and colon LEDs at rate of 1s.

Estimated time of the selected program



After selecting a program, the estimated time is displayed in hours and minutes (for example 1.05). The estimated time is calculated automatically on the basis of the maximum recommended load for each program. After the program has started, the time remaining is updated every minute.

End Of Program



When the program is completed display show will show "End".

Alarm Codes



In the event of operating problems, some alarm codes can be displayed, for example E20 (see "Troubleshooting" and "Troubleshooting fault displays" on page 26, 27, 28).

Stand by/ Auto off



Colon ":" LED lights up, Static.

Incorrect Option Selection



If an option is not compatible with selected program, display will flash "---" with 3 consecutive short beeps.

3.7 START/PAUSE BUTTON

To start the selected program, press the "Start/Pause" button.

If you have started your wash and you wish to stop it for some reason, press the "Start/Pause" button to enter PAUSE mode. To restart the program from the point at which it was interrupted, press the "Start/Pause" again.

i If the lid has been opened any time during operation of the machine, the Start/Pause button has to be pressed when the lid is closed to continue operation.

3.8 DELAY END OPTION BUTTON

(SWT6055TMWA, SWT7055TMWA, SWT7055LMWA)

Before you start the program, this option makes it possible to delay the end of the washing program by 2, 4, 6, 8, 10 or 12 hours, by pressing Delay End button to choose the end time as your wish. This option must be selected after choosing the wash program, and before pressing the "Start/Pause" button. If after having set the Delay-End option (and pressed "Start/Pause" button) and you wish the cancel or modify it, follow the below steps:

- set the washing machine to PAUSE by press "Start/Pause" button;
- deselect the Delay-End option, changing the status;
- press the "Start/Pause" to start the program.

YOUR PROGRAM GUIDE

Program	Available Model		Select this program	Recommended			
	SWT7055TMWA SWT7055LMWA SWT6055TMWA	SWT6555TMWA		Water Level	Temp	Spin	Rinse Option
Regular *	Yes	Yes	For normally soiled cotton load at rated load capacity.	Full	Warm	High	Regular /Eco*
Cold	Yes	Yes	For synthetic or mixed fabrics, underwear, coloured garments, non-shrink shirts, blouses.	Full	Cold	High	Regular
Delicates	Yes	Yes	For lingerie, lace, trimmed and embroidered items.	Full	Cold	Medium	Regular
Sports Wear	Yes	Yes	For a Sport ware fabrics labelled "Machine Washable"	Full	Warm	High	Regular
Heavy Duty **	Yes	Yes	For a heavily soiled cotton wash load.	Full	Warm	High	Regular
Bedding	Yes	Yes	For bedding fabrics labelled "Machine Washable"	Full	Hot	High	Regular
Rinse+Spin	Yes	Yes	For items that you want to rinse and spin eg. clothes items you have hand washed in a wash tub.	High	Cold	High	Regular
Spin	Yes	Yes	For very wet clothes to remove the water.	-	-	High	-
Quick 20	Yes	Yes	For a very small load of mixed fabrics.	Low	Warm	High	Fast
Daily 45	Yes	Yes	For a small load of mixed fabrics.	Full	Warm	High	Regular
Soak & Wash	No	Yes	For normally soiled cotton load.	Full	Warm	High	Regular
Favourite ☆	Yes	No	For using favourite program.	-	-	-	-
Delay End	Yes	No	For using Delay End program.	-	-	-	-
Child Lock	Yes	Yes	For using Child Lock program.	-	-	-	-
Favourite (save)	Yes	No	For using Favourite program.	-	-	-	-

Remarks

* "Regular wash, Warm Temp, Full Water Level, No Soak, Eco rinse, Maximum Time Adjust" is recommended for a full load of normally soiled cottons. (SWT7055TMWA/SWT7055LMWA/SWT6055TMWA)

* "Regular Wash, Warm Temp, Full Water Level, No Soak, Eco Rinse" is recommended for a full load of normally soiled cottons. (SWT6555TMWA)

** "Heavy Duty" has a built-in Soak period of 6 minutes.

4. WASHING INSTRUCTIONS

These Washing Instructions are of a general nature and you should get good wash results by following them.

However, due to the variables of fabric types, soil levels, detergent types and available program settings you may find some combinations of these which do not always result in the perfect wash.

If for example you see residuals of detergent or soils on some items, please read the section Residues on washed items paragraph.

Over time you will learn what is the best set-up of programs, detergent and load sorting for different load types and soils.

4.1 SORT YOUR WASHING INTO SEPARATE WASH LOADS



- Each load of washing should contain clothing which needs the same washing conditions. For example, you should not wash delicate clothes with very dirty work clothes.
- Colour fast and non-colourfast fabrics should be separated. Knowing the type of fabrics you have and how dirty they are will help when you make selections from the wash program options.
- Some fabrics are lint collectors and can pick up lint, dirt and colour from other fabrics which are lint producers. Some examples are listed below:

Lint collectors	Lint producers
- Corduroy	- Towels
- Synthetics	- Nappies
- Permanent press fabrics	- Chenille/ Candlewick

i NOTE:

Make sure that you wash lint collectors separately from lint producers.

- Never wash whites and coloureds together. Whites may lose their “whiteness” in the wash.
- New coloured items may run in the first wash; they should therefore be washed separately the first time.
- **!** IMPORTANT!

Make sure that no metal objects are left in the laundry (e.g. hair clips, safety pins, pins).

- Button up pillowcases, close zip fasteners, hooks and poppers.

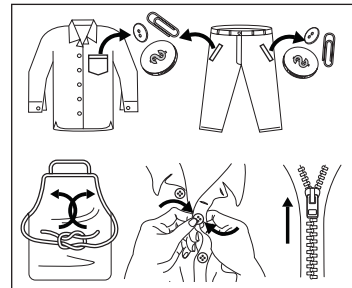

- Tie any belts or long tapes.
- Remove persistent stains before washing.
- Rub particularly soiled areas with a special detergent or detergent paste.
- Treat curtains with special care.

- Wash bras, pantyhose and other delicates in a mesh laundry bag, which you can purchase from your supermarket.

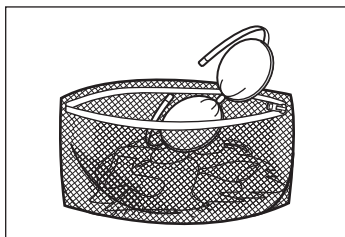

- Remove hooks or tie them up in a bag or net.

4.2 PRE-TREATMENT SPRAYS AND STAIN REMOVERS

! WARNING!

Pre-treatment sprays and stain remover can damage plastic components on your washing machine.

If you use pre-treatment sprays or stain removers, apply them to the clothing well away from your washing machine.

4.3 DETERGENT

Good washing results also depend on the choice of detergent and use of the correct quantities to avoid waste and protect the environment.

Although biodegradable, detergents contain substances which, in large quantities, can upset the delicate balance of nature.

The choice of detergent will depend on the type of fabric (delicates, woollens, cottons, etc.), the colour, washing temperature and degree of soiling.

- Don't use the wrong type of detergent. You must use a low sudsing detergent designed for front load washing machines or high efficiency top loaders, such as Cold Power for Front Loaders and High Efficiency Top Loaders or detergents labelled "Matic".
- Don't use soap-based products in your washing machine.
- Don't use too much detergent. This can result in excessive suds that can cause low spin speeds, poor rinsing and overloading the motor during spin stages of the wash program.
- Don't use too little detergent because you will get a poor wash. If you think you need more, increase dosages by only small amounts to avoid excessive suds.

Quantity of detergent to be used

The type and quantity of detergent will depend on the type of fabric, load size, degree of soiling and hardness of the water used.

Water hardness is classified in so-called "degrees" of hardness.

Information on hardness of the water in your area can be obtained from the relevant water supply company, or from your local authority.

Follow the product manufacturers' instructions on quantities to use.

- Not enough washing powder causes: the washload to turn grey, greasy clothes.
- Too much washing powder causes: sudsing, reduced washing effect, inadequate rinsing.
- Use less detergent if: you are washing a small load, the laundry is lightly soiled, large amounts of foam form during washing.

5. DAILY USE

5.1 STARTING YOUR WASHING MACHINE

1. Connect the mains plug to the mains socket.
2. Turn the water tap on.

5.2 LOAD THE WASHING MACHINE

When loading the clothes into your washing machine, there are four things to remember:

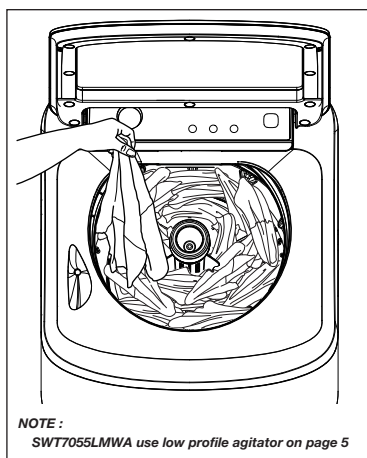

1. Clothes must be loaded evenly around the agitator. For best results load small items first, followed by large items. For example, a typical load should be loaded using the following sequence: handkerchiefs, wash cloths, undershorts, pillow cases, T-shirts, business shirts, tablecloths, sheets, bath towels.
2. Clothes must not be wrapped around the agitator.
3. The washing machine must not be overloaded. Clothes must be able to move during wash.

4. The load should contain only three or four large items, for example sheets. The rest of the load should be small items. A mixed load of large and small items will wash cleaner than a load of all large items.

5.3 ADD THE DETERGENT

1. Measure the correct amount of powder or liquid detergent by following the recommendations on the package.
2. Mix detergent in one litre of hot or warm water.
3. Add the pre-mixed detergent to the wash load.

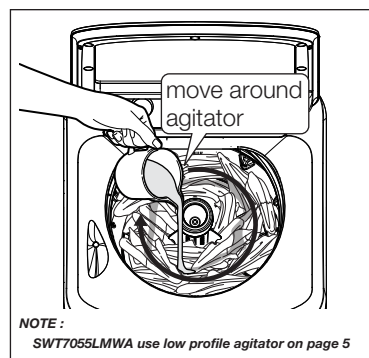

! Don't do these things:

- Using too little detergent will give you a poor wash result.
- Using excessive detergent will create too much suds and may cause overloading of the motor during the spin stage of the wash cycle. To avoid excessive suds, reduce the amount of detergent you use. It is best to use detergent labelled low sudsing. Good quality, front load detergent will perform well in this machine.
- Use soap based products in your washing machine.

5.4 ADD FABRIC SOFTENER

FOR SWT6055TMWA
SWT6555TMWA
SWT7055TMWA

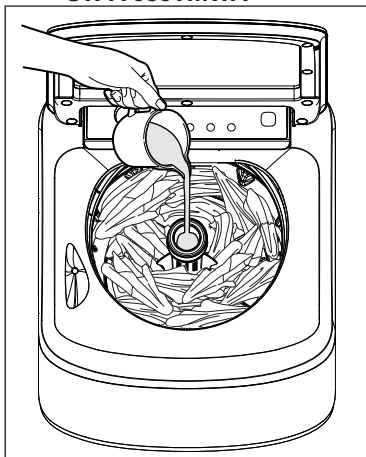

1. Measure the correct amount of fabric softener by following the recommendations on the package.
2. Mix softener with an equal amount of warm water but only mix enough to fill to the line marked inside the cup. The softener cup holds 75ml.
3. Pour the mixed softener into the cup in the top of the agitator. Do not overfill the cup.

! Do not spill fabric softener on the clothes as it may stain them.

4. If you are going to use fabric softener, you must select the Regular rinse option, ie deselect the ECO RINSE option.

NOTE: You do not have to use fabric softener, your washing machine will wash the clothes perfectly well without it.

FOR SWT7055LMWA

Before adding softener to the dispenser, make sure the siphon cap is pushed firmly down onto the spigot in the drawer.

The softener will not siphon out if the cap is incorrectly fitted, is missing or blocked with residue. You are now ready to add fabric softener.

Measure the correct amount as recommended on the softener package into a cup and then pour it into the softener compartment of the dispenser drawer.

Caution: Do not overfill the fabric softener dispenser.

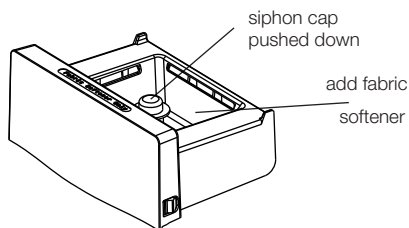

Overfilling and then siphoning out too early can cause softener and detergent to mix resulting in staining problems.

The softener dispenser holds in the drawer when filled up to the MAX marker. Any level lower than MAX will function correctly.

Caution: Only for fabric softener. Do not add detergent in this compartment.

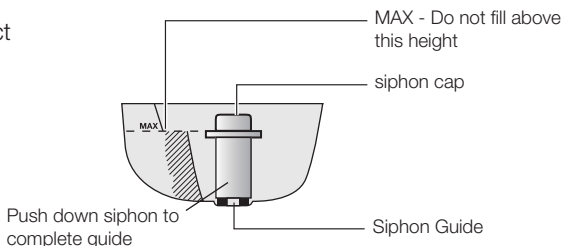

5.5 ADDING BLEACH

Bleaching of clothes can help to remove stains, heavy soiling and to kill bacteria.

Oxygen Type

This is generally a powder type bleach. Mix the required quantity with water and pour down the bleach hole in the top panel during the fill when there is some water in the washbowl.

Chlorine Type

This type of bleach **should not be mixed with detergent**. Mix the bleach with water as per the instructions on the container.

How to soak with bleach, proceed as follows:

1. Turn Program Selector to a Regular Wash position.
2. Press the Start/Pause button to commence water fill.

3.



NOTE :
SWT7055LMWA use low profile agitator on page 5

Pour the bleach solution down the hole in the top panel during fill when there is some water in the wash bowl.

4. Allow the machine to agitate for a few minutes, **then let it stand for the required time by pressing Start/Pause button to pause the machine.**
5. When soaking bleach reached to the required time, turn Program Selector to Drain+Spin position and press the Start/Pause button to empty the wash bowl.

5.6 SETTING A PROGRAM

1. Turn the program selector to the required program.
 - Your washing machine is now in STAND-BY-MODE and ready to wash your clothes.
 - The relevant light will light up.
 - The buzzer will sound.
 - The selector dial can be turned either clockwise or anticlockwise.
 - Once you selected a program, the program selected will stay at that position for the whole of the cycle.
 - The display shows the program duration.

If the settings shown on the control panel are what you want to use, press the Start/Pause button to start your wash.

2. If you want your laundry to be washed with functions different from the one proposed by the machine, press Temperature, Water Level, Soak Time and Rinse Option buttons.

i NOTE:

Different functions can be combined which is dependent on the program selected.

When these buttons are pressed, the corresponding pilot lights come on.

3. If you want to define the end of the washing program, press the "Delay End" button repeatedly to choose your machine end time.

5.7 STARTING A PROGRAM

To start a program, press the Start/Pause button, a default program duration will be displayed on the screen.



NOTE

- When you select the Drain+Spin program, there will be a delay of at least 2 minutes before the washing machine starts to spin. This delay is a pump out (Drain) period to ensure the bowl is empty of water, which is necessary before spin commences. Even though you may have only put wet clothes into an empty bowl, the delay before spin will still occur to be safe and to protect your washing machine.

5.8 CHANGING A PROGRAM

You can turn the Program Selector Knob to a new program position at any time. If you do move the Program Selector Knob the effect will be different depending on the status of the machine at the time you do this, as follows:

- When the machine is running, moving the Knob to a new position will result in the machine continuing the wash and the display will show “ --- ” and flashing with 3 consecutive short beeps to remind you that this option is not allowed.

5.9 INTERRUPTION OF A PROGRAM

If you have started your wash and you wish to stop it for some reason, press the Start/Pause button to enter PAUSE mode. Time digits and colon LEDs blink.

Press the Start/Pause again. The program will continue.

5.10 AT THE END OF THE PROGRAM

- The appliance stops automatically.
- The display will show “ End ”
- Turn the Program Selector knob to the position “Off”.
- Remove the laundry from the appliance. Make sure that the washing tub is empty.
- Keep the lid ajar, to prevent the mildew and odours.
- Turn off the water tap.

6. CARING FOR YOUR WASHING MACHINE

Your washing machine will give you long and trouble-free service, if you follow the instructions in this section. These instructions show you how to care for your washing machine.

6.1 WHAT TO DO AFTER YOU HAVE FINISHED YOUR WASHING.

1. Turn the Program Selector knob to the position "Off".
2. Switch off the electricity at the power point.
3. Turn off the water taps. This will extend the life of the inlet hoses.
4. Leave lid open for a while. This allows time for moisture inside the washing machine to evaporate and for any odours to disperse.

6.2 CLEANING THE LINT FILTER

Lint is a collection of threads and fluff which comes off your clothes during washing. Your washing machine collects this lint in the lint filter. It is important to clean out this lint filter preferably after each wash.

How to clean the lint filter:
SWT6055TMWA/SWT6555TMWA
SWT7055TMWA

1. Remove the softener dispenser cup and filter column from the centre of the agitator.

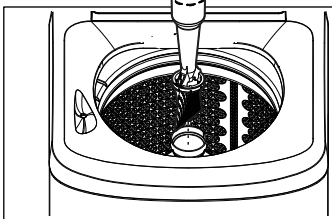

2. Unclip the filter bag from the column.

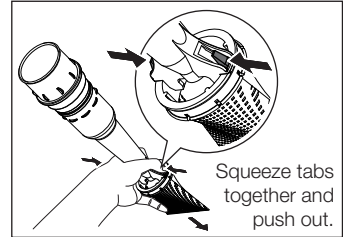

3. Turn the bag inside out and remove the lint.

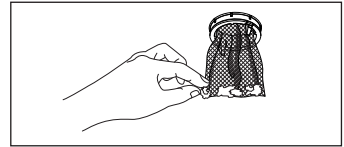

4. Wash the filter bag and dispenser cup in hot water.
5. Reassemble the filter to the column and place it back in the centre of the agitator.

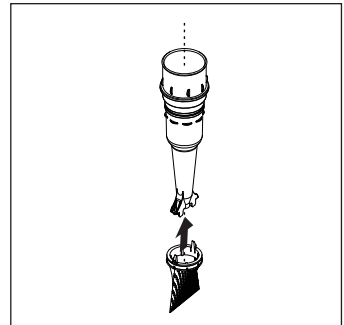

6.3 CLEANING THE DISPENSER (SWT7055LMWA)

The dispenser needs to be cleaned regularly, preferably after each wash. Inspect the dispenser after each wash to see if there is any residue of detergent.

To do this proceed as follows:

- Pull the dispenser drawer forward until it stops.
- Lift the front of the drawer up and forward to remove it from the runners.
- Clean the dispenser drawer with hot water and a brush, eg. an old toothbrush.
- Dry the drawer.
- Before replacing the dispenser back in its recess, clean the inside of the drawer with an old toothbrush.
- Put the dispenser back into its runners and close the drawer.

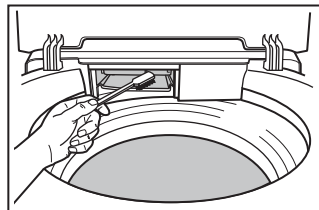

6.4 CLEANING YOUR WASHING MACHINE

To clean the inside and outside of your washing machine you should:

1. Wipe the surface with a mild dishwashing detergent and warm water.
2. Wipe dry with a soft cloth.

i **IMPORTANT:** Never use solvents, aerosol cleaners, spray pack cleaners, glass, cleaners, metal polishes, caustic materials, scourers or general household cleaners on or near top panel and lid, control panel or other parts of your washing machine.

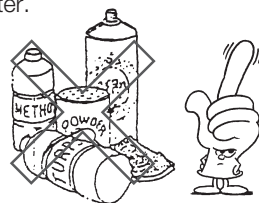

6.5 CLEANING STAINS IN THE WASHBOWL

Stains in the wash bowl can be caused by:

- metal objects such as bobby pins, dressmaking pins and nails;
- salt;
- body oils and grease from very dirty or sweaty clothes being deposited around the top of the washbowl;
- excessive foam during wash if incorrect or too much detergent is used.

i IMPORTANT:

Check all pockets before loading clothes into your washing machine.

Don't leave wet clothing (especially swimwear) in the bowl for too long before you wash it.

How To Clean the Stainless Steel Wash Bowl :

1. Wipe with a cleaning product which is marked suitable for stainless steel.
2. Oily deposits can be removed by wiping surfaces with a mild dishwashing detergent and warm water.

i IMPORTANT:

Never use bleach cleaners or steel wool to clean the stainless steel washbowl.

6.6 AVOIDING BUILD UP OF UNDISSOLVED DETERGENTS

If you only wash with cold water, undissolved detergent and body oils will build up in the washing machine. This build-up can cause spotting on your clothes.

To avoid this build-up :

- do not use too much fabric softener with cold water;
- select a hot water wash at least once a month;
- always dissolve the detergent in one litre of warm water.

7. HELPFUL HINTS IN DEALING WITH WASHING PROBLEMS

7.1 RESIDUES ON WASHED ITEMS

Some detergents have ingredients which do not fully dissolve and as a consequence, may leave white residue or particles evident on the surface of darker clothes in the finished wash load. Similarly some soils may not dissolve fully, resulting in residue evident on lighter coloured clothes.

If you are experiencing residue on some clothes, the following tips will help:

- Check that you are using frontload type detergent to minimise over-sudsing. You may find different brands of detergent give better results. Liquid detergent may be better than powder in your situation.
- Pre-mix the detergent thoroughly in warm or hot water to improve the dissolving.
- Reduce detergent dosage to between a 1/2 and 2/3 of the manufacturer's standard recommendation to avoid over concentration (the lower water usage requires lower detergent usage.)
- Some residue maybe re-deposited lint, so be careful not to have lint-producing items in a load which has darker clothes.
- Select deep rinse and not eco rinse to help flush more particles away.
- Reduce the clothes load size per wash to give more freedom for the clothes to move around in the wash bowl.

- Use another program as below, which has been designed to minimise residual particles (they are in order of increasing benefit and will help you choose the best program for your wash load.)
 - The Colours Program
 - The Heavy Duty Program

7.2 STAINED CLOTHES - HINTS FOR REMOVING STAINS

The guide to stain removal on page 24 may assist you in stain removal.

Treat all stains as soon as possible. The longer you leave a stain the harder it will be to remove. Try soakers and stain removers first.

If you use pre-treatment sprays or stain removers, apply them to the clothes items in a well ventilated area away from your washing machine.

- Avoid the use of hot water on stains as hot water will set stains.
- Use light strokes and don't rub the stain remover into the fabric.
- If you use a chlorine bleach, follow the instructions on the bottle and dilute it before putting it on clothing.
- Test coloured fabrics on an inside seam for colour fastness before using any stain removers or bleaches.
- Test synthetic fabric on an inside seam before using any chemicals or bleaches.

NOTE:

Chemicals referred to for stain removal are available from your local supermarket, hardware store or the chemist.

! WARNING!

Pre-treatment sprays and stain removers can damage plastic components on your washing machine.

! CAUTION!

Do not use dry cleaning fluids or solvents near your washing machine. These fluids will damage your washing machine and may cause an explosion.

7.3 YELLOWING OR GREYING CLOTHES

Problem	Possible causes	What to do
Greyness	<ul style="list-style-type: none"> • Incorrect wash times and using insufficient detergent which can cause redepositing of detergent on clothes. • Using incorrect type or too much detergent can cause poor rinsing and poor spin performance. • Mixing whites with very dirty clothes, eg work clothes. • Using soap flakes instead of laundry detergent. 	<ol style="list-style-type: none"> 1. ONLY use low sudsing, front load washer detergent in this machine, such as Cold Power for Front Loaders and High Efficiency Top Loaders or detergent labelled "Matic". 2. Re-sort load, then re-wash using program selections suitable for the fabric using hot or warm water. 3. If the water is very dirty or very sudsy, repeat 2 above reducing the amount of detergent you use.
Yellowing	<ul style="list-style-type: none"> • A build-up of oils in clothes that come into close contact with the skin, eg underwear, T-shirts. • Ageing of clothes. Iron deposits in the wash water. • Use of chlorine bleaches on fabrics with resin finishes. • Incorrect drying. • Incorrect water temperatures ie. too hot or too cold. 	<ol style="list-style-type: none"> 1. Re-sort load, then re-wash using wash program selections suitable for the fabric using hot or warm water. 2. If the water is very dirty or very sudsy, repeat 1 above reducing the amount of detergent you use. <p><i>NOTE: Synthetics which have been washed in very hot water will not respond to any treatment.</i></p>

8. A GUIDE TO STAIN REMOVAL

Stain	White Cottons And Linens	Washable Coloured Fabrics
Ball Point Pen Ink	Sponge with methylated spirit. Bleach if required.	Same as for whites - use oxygen type bleach.
Beetroot	Rinse as soon as possible under cold water. Bleach if necessary.	Same as for whites - use oxygen type bleach.
Blood, Meat Juice, Egg (Dry Stain)	Cover area with meat tenderiser (msg). Apply warm water to make a paste. Wait 15-20 minutes. Sponge with cool water or with diluted bleach.	Same as for whites but select water temperature suitable to fabric - use oxygen type bleach.
Blood, Meat Juice, Egg (Fresh Stain)	Rinse in cold water. If stain remains, sprinkle with meat tenderiser (msg). Let stand for 15-20 minutes. If stain still remains, then sponge with diluted bleach. Wash using hot water.	Same as for whites but select water temperature suitable to fabric - use oxygen type bleach.
Candle Wax	Scrape off excess, place stain between clean white blotter or several layers of facial tissue. Sponge with dry cleaning fluid. If spot remains, bleach.	Same as for whites - use oxygen type bleach.
Chewing Gum	Rub with ice to harden. Scrape off excess with blunt knife. Sponge with dry cleaning fluid.	Same as for whites.
Chocolate	Soak in warm water with pre-soak product, and wash in lukewarm water. Use dry cleaning fluid (white spirits) to remove any grease spots.	Soak in warm water with pre-soak or detergent solution. Treat any remaining stain with oxygen bleach.
Coffee/tea (Milk Or Cream)	Rinse or soak in cold water. Work detergent into stain. Thoroughly rinse and dry. If a stain remains, sponge with dry cleaning fluid. If stain remains, bleach.	Same as for whites - use oxygen type bleach.
Coffee/tea (Black), Fruit Juice, White Wine	Pour boiling water through stain. Bleach if necessary.	Soak or rinse in cold water or sponge with warm water and detergent. Use oxygen type bleach.
Correcting Fluid	Scrape off as much as possible. Rub clean with paint thinner or white spirits.	Same as for whites.
Cosmetics	Sponge with prewash stain remover, liquid detergent or rub with soap. If greasy stain persists, soak in enzyme product then wash.	Same as for whites.

Stain	White Cottons And Linens	Washable Coloured Fabrics
Curries	Soak/rinse in lukewarm water until a majority of the colour is removed. Sponge with solvent to break down any remaining fats and oils then wash.	Same as for whites. Check for colour fastness before applying solvent.
Fat/Grease/ Oil	Sponge with dry cleaning fluid (white spirits).	Same as for whites.
Fruit	Sponge with warm water and wash. Bleach remaining stain with oxygen bleach.	Pour boiling water through stain. Bleach remaining stain.
Grass, Green Vegetables	Sponge with methylated spirit. Wash using warm water.	Same as for whites. Check colourfastness before applying methylated spirit. For acetate, sponge with dry cleaning fluid.
Ice Cream, Cream Milk	Rinse or soak in cold water then wash. If ice cream contains fruit or chocolate treat as such.	Same as for whites.
Iodine	Wash using hot water.	Wash using warm water.
Iron Rust	Apply oxalic acid and place in sun.	Apply lemon juice and place in sun.
Lipstick	Rub with lard and wash using hot water. Bleach if necessary.	Rub with lard and wash using warm water.
Mildew	Wash using hot water. Moisten with lemon juice and let dry in sun. If stain persists, bleach. Old stains are hard to remove.	Same as for whites but select water temperature to suit fabric.
Mustard	Wash using hot water and bleach.	Wash using warm water and use oxygen bleach.
Nail Polish	Sponge with dry cleaning fluid or nail polish remover. Bleach remove dye.	Sponge with dry cleaning fluid.
Paint (Oil Based)	Scrape off fresh paint. Soften dry paint with lard or oil, then sponge with turpentine (turps).	Same as for whites.
Red Wine	Rub salt into the stain. Pour boiling water through stain. Bleach if necessary.	Same as for whites.
Scorch	Moisten and place in sunlight. Bleach if necessary.	Usually a permanent stain. Brush wools lightly with sandpaper.
Tomato Sauce	Soak in cool water for 10 minutes. Rub in liquid detergent then wash. If stain persists, try dry cleaning fluid or bleach.	Same as for whites - use oxygen type bleach.

9. TROUBLE SHOOTING

DO NOT call for service until you have checked the points listed below.

If you call for service and there is nothing wrong with your washing machine, you will have to pay for the service call.

You will have to pay even when your washing machine is under warranty. Before you call for service, check the points in the table below.

Problem	Display Code	Possible Causes	What to do
Machine not working.		Power not switched on.	Switch on power point.
		No electricity supply through the power point.	Check power point with another appliance.
	E10	Water taps not turned on.	Turn on taps.
	EFO	Out of balance detected.	Open lid, redistribute load and close lid.
	Ld	Lid not fully closed.	Close lid.
Machine has washed load but will not spinning.	EFO	Out of balance.	Open lid, redistribute load, close lid.
	Ld	Lid not fully closed.	Close lid.
Water in wash bowl.	E20	Drain hose blocked.	Check drain hose for blockage. Wait a short while, press start to continue.
Will not fill with water.	E10	Water taps not turned on.	Turn taps on.
		Inlet hoses blocked.	Clean inlet hose filters.
Water flowing into wash bowl indefinitely.	E10	Drain hose too low.	Raise drain hose or fit a syphon break. Refer to installation instructions for correct positioning of hose.
Machine goes out of balance or vibrates excessively when spinning.	EFO	Machine not levelled.	Level the machine properly.
		Levelling feet not adjusted.	Adjust feet to touch the floor.
		Clothes not evenly distributed.	Redistribute clothes evenly.
Water on floor.		Loose inlet hose connections.	Check connections at taps and rear of machine.
		Loose drain hose connections.	Check connections at rear of machine.
Water splash.		Machine not levelled.	Level the machine properly.
		Water Level selection not correct.	See water level description on page 9.

Problem	Display Code	Possible Causes	What to do
Clothes still dirty after wash completed.		Not enough or no detergent.	Check detergent use and rewash clothes.
		maximum load exceeded.	Remove some clothes and rewash.
		Incorrect wash program or temperature selected.	Reselect program or temperature and rewash.
Scraping noise on spin.		Bra wire or other thin items caught between inner and outer washbowls.	If the item is visible, remove it with pliers. Use a wash bag in future.
Humming, clicking and other noises.		Bowl rotation at start of wash.	Normal noise.
		Brake activation when stopping after spin.	Normal noise.

TROUBLESHOOTING FAULT DISPLAYS

If you have a problem with your washing machine and before you call service, make sure you have followed ALL of the instructions that may remedy the problem. You will find instructions in the 'Troubleshooting' section and in the table below.

When the washing machine detects a problem that requires your attention, you will be alerted. The machine will warn you of this problem by displaying a fault code in the digital display, accompanied by "Beeping".

Fault information and the action you should take are described in the following table.

Description	Display Code	Customer action (Summary)
Not filling with water	E10	Make sure both taps are on and hose filters are not blocked. Raise drain hose if water is flowing out of drain hose. Press "Start/Pause" to re-start wash. If problem remains, call Service.
Flood	E30	If the water is pouring onto the floor, turn OFF both taps. Wait a few minutes to see if the fault is corrected. If not, call Service.
Draining problem	E20	Wait a few minutes to see if the fault is corrected. If not, set the washing machine to PAUSE by press "Start/Pause" button then check the drain hose for blockage. Press "Start/Pause" to continue the wash. If problem remains, call Service.
Loss of water, while washing	E10	If water level in wash bowl is low and water is leaking on the floor, rotate the PROGRAM KNOB to "Spin" program, then press "Start/Pause" button. Should this make things worse, turn off the machine and call Service. Otherwise, press "Start/Pause" to continue the wash.
Water level problem	E30	Wait, this fault may clear itself. If not, rotate the PROGRAM KNOB to "Spin" program, then press "Start/Pause" button to drain the wash bowl. If this problem is repeated, call Service.

10. ENVIRONMENT CONCERNS

Packaging materials



The materials marked with the symbol  are recyclable.

>PE<=polyethylene

>PS<=polystyrene

>PP<=polypropylene

This means that they can be recycled by disposing of them properly in appropriate collection containers.

Old machine

Use authorised disposal sites for your old appliance. Help to keep your country tidy!



The symbol  on the product or on its packaging indicates that this product may not be treated as household waste.

Instead it shall be handed over to the applicable collection point for the recycling of electrical and electronic equipment.

By ensuring this product is disposed of correctly, you will help prevent potential negative consequences for the environment and human health, which could otherwise be caused by inappropriate waste handling of this product.

For more detailed information about recycling of this product, please contact your local city office, your household waste disposal service or the shop where you purchased the product.

Ecological hints

To save water, energy and to help protect the environment, we recommend that you follow these tips:

- Normally soiled laundry may be washed without prewashing in order to save detergent, water and time (the environment is protected too!).
- The machine works more economically if it is fully loaded.
- With adequate pre-treatment, stains and limited soiling can be removed; the laundry can then be washed at a lower temperature.
- Measure out detergent according to the water hardness, the degree of soiling and the quantity of laundry being washed.



FOR SALES IN AUSTRALIA AND NEW ZEALAND
APPLIANCE: SIMPSON WASHING MACHINES

This document sets out the terms and conditions of the product warranties for Simpson Appliances. It is an important document. Please keep it with your proof of purchase documents in a safe place for future reference should there be a manufacturing defect in your Appliance. This warranty is in addition to other rights you may have under the Australian Consumer Law.

1. In this warranty:

- (a) 'ACL' or 'Australian Consumer Law' means Schedule 2 to the Competition and Consumer Act 2010;
- (b) 'Appliance' means any Electrolux product purchased by you and accompanied by this document;
- (c) 'ASC' means Electrolux's authorised serviced centres;
- (d) 'Simpson' is the brand controlled by Electrolux Home Products Pty Ltd of 163 O'Riordan Street, Mascot NSW 2020, ABN 51 004 762 341 in respect of Appliances purchased in Australia and Electrolux (NZ) Limited (collectively "Electrolux") of 3-5 Niall Burgess Road, Mount Wellington, in respect of Appliances purchased in New Zealand;
- (e) 'Warranty Period' means the period specified in clause 3 of this warranty;
- (f) 'you' means the purchaser of the Appliance not having purchased the Appliance for re-sale, and 'your' has a corresponding meaning.

2. Application: This warranty only applies to new Appliances, purchased and used in Australia or New Zealand and is in addition to (and does not exclude, restrict, or modify in any way) other rights and remedies under a law to which the Appliances or services relate, including any non-excludable statutory guarantees in Australia and New Zealand.

3. Warranty Period: Subject to these terms and conditions, this warranty continues for in Australia for a period of 24 months and in New Zealand for a period of 24 months following the date of original purchase of the Appliance.

- Inverter motor – Further 8 years

4. Repair or replace warranty: During the Warranty Period, Electrolux or its ASC will, at no extra charge if your Appliance is readily accessible for service, without special equipment and subject to these terms and conditions, repair or replace any parts which it considers to be defective. Electrolux may, in its absolute discretion, choose whether the remedy offered for a valid warranty claim is repair or replacement. Electrolux or its ASC may use refurbished parts to repair your Appliance. You agree that any replaced Appliances or parts become the property of Electrolux.

5. Travel and transportation costs: Subject to clause 7, Electrolux will bear the reasonable cost of transportation, travel and delivery of the Appliance to and from Electrolux or its ASC. Travel and transportation will be arranged by Electrolux as part of any valid warranty claim.

6. Proof of purchase is required before you can make a claim under this warranty.

7. Exclusions: You may not make a claim under this warranty unless the defect claimed is due to faulty or defective parts or workmanship. This warranty does not cover:

- (a) light globes, batteries, filters or similar perishable parts;
- (b) parts and Appliances not supplied by Electrolux;
- (c) cosmetic damage which does not affect the operation of the Appliance;

(d) damage to the Appliance caused by:

- (i) negligence or accident;
- (ii) misuse or abuse, including failure to properly maintain or service;
- (iii) improper, negligent or faulty servicing or repair works done by anyone other than an Electrolux authorised repairer or ASC;
- (iv) normal wear and tear;
- (v) power surges, electrical storm damage or incorrect power supply;
- (vi) incomplete or improper installation;
- (vii) incorrect, improper or inappropriate operation;
- (viii) insect or vermin infestation;
- (ix) failure to comply with any additional instructions supplied with the Appliance;

In addition, Electrolux is not liable under this warranty if:

- (a) the Appliance has been, or Electrolux reasonably believes that the Appliance has been, used for purposes other than those for which the Appliance was intended, including where the Appliance has been used for any non-domestic purpose;
- (b) the Appliance is modified without authority from Electrolux in writing;
- (c) the Appliance's serial number or warranty seal has been removed or defaced.

8. How to claim under this warranty: To enquire about claiming under this warranty, please follow these steps:

- (a) carefully check the operating instructions, user manual and the terms of this warranty;
- (b) have the model and serial number of the Appliance available;
- (c) have the proof of purchase (e.g. an invoice) available;
- (d) telephone the numbers shown below.

9. Australia: For Appliances and services provided by Electrolux in Australia: Electrolux goods come with guarantees that cannot be excluded under the Australian Consumer Law. You are entitled to a replacement or refund for a major failure and for compensation for any other reasonably foreseeable loss or damage. You are also entitled to have the Appliance repaired or replaced if the Appliance fails to be of acceptable quality and the failure does not amount to a major failure. 'Acceptable quality' and 'major failure' have the same meaning as referred to in the ACL.

10. New Zealand: For Appliances and services provided by Electrolux in New Zealand, the Appliances come with a guarantee by Electrolux pursuant to the provisions of the Consumer Guarantees Act, the Sale of Goods Act and the Fair Trading Act. Where the Appliance was purchased in New Zealand for commercial purposes the Consumer Guarantee Act does not apply.

11. Confidentiality: You accept that if you make a warranty claim, Electrolux and its agents including ASC may exchange information in relation to you to enable Electrolux to meet its obligations under this warranty. For more information on how we handle your personal information, see our privacy policy at www.electrolux.com.au/other/privacy/ or www.electrolux.co.nz/other/privacy/

Important Notice

Before calling for service, please ensure that the steps listed in clause 8 above have been followed.

<p>FOR SERVICE or to find the address of your nearest authorised service centre in Australia PLEASE CALL 13 13 49 For the cost of a local call (Australia only)</p>	<p>AUSTRALIA ELECTROLUX HOME PRODUCTS 163 O'Riordan Street, Mascot NSW 2020 electrolux.com.au</p>	<p>FOR SPARE PARTS IN AUSTRALIA please visit shop.simpson.com.au or call 13 13 50 For the cost of a local call (Australia only)</p>
<p>FOR SERVICE or to find the address of your nearest authorised service centre in New Zealand PLEASE CALL 0800 10 66 10 (New Zealand only)</p>	<p>NEW ZEALAND ELECTROLUX (NZ) Limited 3-5 Niall Burgess Road, Mount Wellington electrolux.co.nz</p>	<p>FOR SPARE PARTS IN NEW ZEALAND or to find the address of your nearest spare parts centre in New Zealand PLEASE CALL 0800 10 66 20 (New Zealand only)</p>



REVISION:	DATE:	DETAIL:	REQUESTED BY:	REMARK:
001	5 Feb 2020	New create for Mini 7kg Agitator	Worawoot K.	New Create

NOTE: THIS PAGE IS A GUIDELINE NOT AN ARTWORK
DO NOT PRINT

COLOUR

1	Gray Scale	

BRAND Electrolux	User Manual for MINI-SIMPSON SWT7055LMWA, SWT6555TMWA
BY Worawoot K.	SWT6055TMWA, SWT7055TMWA
DATE -	A12246403 TITLE
SCALE 100%	ARTWORK NO.: G0028013 Rev. 01