

Contemporary
Design
Collection

Oliveri®

Quality
Shines





www.oliverisinks.com

Oliveri | Inspirational designs

The kitchen is the heart of your home. From the time you wake up in the morning right through to late night entertaining, your kitchen plays a major role. Beyond basic practicality, today's kitchens and the various elements that create them are also the centrepiece of style and innovation. It is this pursuit of design excellence that provides



the inspiration behind the latest range of Oliveri sinks. The Oliveri sinkware range has been created to enhance and complement the other appliances in your kitchen. The clever use of custom accessories transform your Oliveri sink into a total food-processing centre, without ever sacrificing your precious bench space. If it's not an Oliveri, it's a compromise.



MO793 shown with AC73 Stainless Steel Utility Tray, AC72 'D' Colander, AC74 Solid Timber Preparation Board all supplied as standard. Shown with optional extra MG513 Mixer Tap.

Contents

- 04 **Monet**
A modern masterpiece
- 06 **Solitaire**
The versatile all-rounder
- 08 **Petite**
Stylish & elegant
- 10 **Ultraform**
Functional & affordable
- 12 **Duoform**
Practicality & capacity
- 14 **Martini**
At home behind the bar
- 15 **Accessories**
Beyond a sink
- 16 **Tapware**
The perfect partner
- 18 **Specifications & dimensions**



www.oliverisinks.com

Monet | A modern masterpiece

Not even the Europeans can match the style and refinement of the Oliveri Monet. The Monet's modern design and soft curved ends are designed to beautifully complement the other stylish items in your kitchen. However, to be a valuable addition to your kitchen, beauty alone is not enough. The Oliveri Monet affords you the best of both worlds by blending refined elegance with unparalleled practicality.



AC73 Stainless Utility Tray
Extend the versatility of your Monet sink.



Stylish Curved Ends
Complements other items in your kitchen.



Optional Linen Finish (MO701L, MO702L)
Enhances the scratch resistance of your Monet.



Included Accessories



AC14
Basket Waste



AC72
'D' Colander



AC74
Solid Timber
Preparation Board



AC73
Stainless Steel Utility Tray
(MO793, MO763, MO715)

MO793 shown with MG513 Mixer Tap as an optional extra.



Features



'D-Shaped' Extra Capacity Main Bowl
The Monet's design allows for a larger capacity main bowl without a reduction in drainer space.



Off-Centre Outlets
By placing the drain outlets to the rear of the bowl the Monet helps to maximise the precious storage space available under your sink.



Generous Capacity $\frac{3}{4}$ or $\frac{1}{2}$ bowl
The larger capacity of Monet's secondary bowls make them wonderfully practical and genuinely useable.



Tap Landing
The Monet's purpose designed tap area is easy to clean and has been precision engineered to accommodate most brands of mixer taps.



18/10 Stainless Steel
Oliveri sinks are manufactured from genuine 18/10, 304 grade stainless steel, for optimum hygiene and durability.



Oliveri Logo
The Oliveri signature represents over 50 years of world class sinkware manufacture in Australia. If it's not an Oliveri, it's a compromise.



MO715



MO763



MO721 (MO722 REVERSE)



MO701 (MO702 REVERSE)



MO701L (MO702L REVERSE) LINEN FINISH



MO793



MO711 (MO712 REVERSE)



MO771 (MO772 REVERSE)



MO753

Optional Accessories



AC73
Stainless Steel Utility Tray



AC71
Stainless Steel Drainer Basket



AC16
Benchtop Drainer Tray



www.oliverisinks.com

Solitaire | The versatile all-rounder

As simply elegant stand alone bowls or stunning combination models, Solitaire sinks combine beauty with functionality. This versatile range is designed to install into all types of modern benchtop materials and features an array of clever accessories that assist in maximizing your precious bench space. A multipurpose stainless steel utility tray with protective rim is included as standard with double bowl models.



Teardrop Tap Landing
Keeps wet area within the sink (LR515, LR525).



Versatile Utility Tray
For drying, draining and defrosting.



Accessory Lip
Suits Oliveri's custom designed accessories.



Included Accessories



AC14
Basket Waste



AC53
Round Stainless Steel
Utility Tray (LR563, LR525)



AC50
Solid Timber Preparation
Board (LR521/L, LR522/L)

LR522 sink shown fitted with MV617/6 extendable spray mixer tap.



Features



Large Round Bowl
The large capacity bowl is big enough to handle just about any pot or pan. As shown, this 28cm frypan fits easily into the bowl.



Low Profile Edge
The new low profile edge design is pleasing to the eye and also helps to eliminate a potential dirt trap, making it both aesthetic and hygienic. (LR515 & LR510)



Laundry Choice
Solitaire's well designed bowl depth is easy on your back, but can still accommodate almost any bucket, vase or planter when used with a high arch tap.



18/10 Stainless Steel
Oliveri sinks are manufactured from genuine 18/10, 304 grade stainless steel, for optimum hygiene and durability.

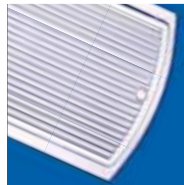

Curved end design
Soft, curved ends create an attractive, elegant shape to complement your other modern kitchen appliances. (LR521/L & LR522/L)



Oliveri Logo
The Oliveri signature represents over 50 years of world class sinkware manufacture in Australia. If it's not an Oliveri, it's a compromise.



LR515/LR510



LR525

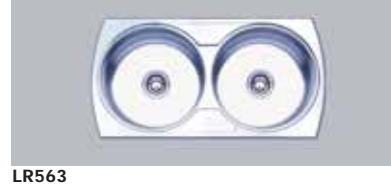

LR563



LR521 (LR522 REVERSE)



LR521L (LR522L REVERSE)

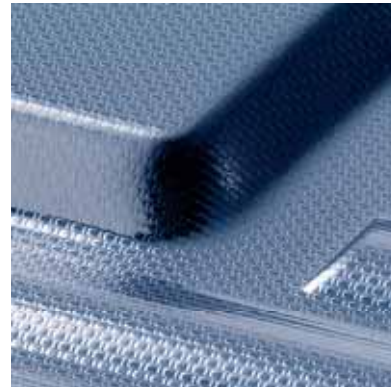

Optional Linen Finish
Enhanced scratch resistance (LR521L, LR522L)



Solitaire makes a perfect addition to any laundry

Optional Accessories



AC50

Solid Timber Preparation Board



AC51

Stainless Steel Drainer Basket



AC53

Round Stainless Steel Utility Tray



www.oliverisinks.com

Petite | Stylish & elegant

The Petite is stylish, elegant and intelligently engineered to set new world standards for stainless steel sinks. The fan-fluted drainers not only look stunning but also efficiently guide more water into the extra capacity, hand finished bowls. When combined with the specialist Oliveri accessories, the Petite is the complete and hygienic food preparation centre and a valuable addition to any kitchen, large or small.



Included Accessories



AC14
Basket Waste



AC15
Solid Timber
Preparation Board



AC18
'D' Colander

PE353 shown with PS113/1 Mixer Tap as an optional extra.



Features



Large Capacity Bowls
The extra capacity bowl of the Petite is designed to accommodate even the biggest pot, pan or wok, making washing-up easier.



Tap Landing
Petite's flat tap landings eliminate dirt traps and have been designed to suit most modern tapware.



Stylish & Functional
Petite's elegant fan fluted drainer, rounded corners and double rim design provide more efficient draining and splash protection.



Bowl Outlet
The drain outlet on most Petite sinks is towards the rear of the bowl, thus saving you valuable under-sink cupboard space.



18/10 Stainless Steel
Oliveri sinks are manufactured from genuine 18/10, 304 grade stainless steel, for optimum hygiene and durability.



Oliveri Logo
The Oliveri signature represents over 50 years of world class sinkware manufacture in Australia. If it's not an Oliveri, it's a compromise.



PE363



PE321 (PE322 REVERSE)



PE301 (PE302 REVERSE)



PE333



PE311 (PE312 REVERSE)



PE371 (PE372 REVERSE)



PE341



PE353

Optional Accessories



AC06

Half Bowl Colander



AC03

Stainless Steel Drainer Basket



AC16

Benchtop Drainer Tray



AC17

Solid Timber Preparation Board



www.oliverisinks.com

Ultraform | Functional & affordable

The Ultraform's functional, intelligent design has resulted in a sink that gives you the best of both worlds. The Ultraform D Series sinks features the special extra-deep bowls that make cleaning larger items a breeze, and yet it takes up less valuable bench space than a regular sink. The highly embossed drainer moves the water quickly away, and with 16 models available, there's sure to be an Ultraform to suit your kitchen.



Included Accessories



AC14
Basket Waste

UF05D shown with PS113/1 Mixer Tap as an optional extra.



Features



Deep Bowl

The Ultraform's extra deep bowl allows you to fully immerse even the largest pot or pan for faster washing or soaking.



Efficient Drainer

The Ultraform's embossed drainer not only looks great but is also designed to drain away water more efficiently.



18/10 Stainless Steel

Oliveri sinks are manufactured from genuine 18/10, 304 grade stainless steel, for optimum hygiene and durability.



Oliveri Logo

The Oliveri signature represents over 50 years of world class sinkware manufacture in Australia. If it's not an Oliveri, it's a compromise.



UF01 (UF02 REVERSE)



UF03D (UF04D REVERSE)



UF05D (UF06D REVERSE)

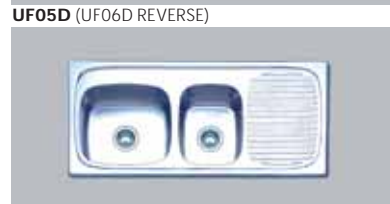

UF07 (UF08 REVERSE)



UF09 (UF10 REVERSE)

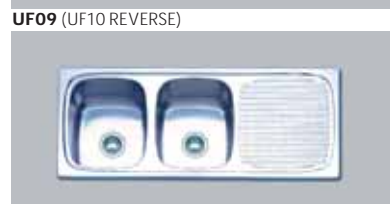

UF11D (UF12D REVERSE)



UF13D



UF14 (UF15 REVERSE)



UF16

Optional Accessories



AC01

Solid Timber Preparation Board



AC02

¼ Bowl Colander



AC06

½ Bowl Colander

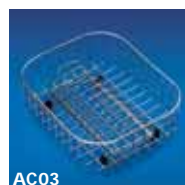

AC03

Stainless Steel Drainer Basket



AC16

Benchtop Drainer Tray



www.oliverisinks.com

Duoform | Practicality & capacity

If you've ever dreamed of a sink with an extra capacity bowl, the Duoform is for you. The mega-size 35 litre bowl is large enough to swallow just about any roasting dish, baking tray or wok and has been ergonomically designed to limit your bending. But this practicality hasn't come at the expense of style. The European inspired design makes Duoform the perfect fashion accessory to any kitchen or laundry.



Included Accessories



AC14
Basket Waste



AC01
Solid Timber
Preparation Board

DU241 shown with PS113/1 Mixer Tap as an optional extra.



Features



35 Litre Mega Bowl
The Duoform features a larger capacity main bowl than most sinks suitable for washing the largest roasting dish or wok with ease.



Stylish & Practical
A stylish and hygienic fan fluted drainer and double rim design is perfect in the kitchen.



Tap Landing
Duoform's rigid tap pad eliminates dirt traps and has been designed to suit most modern mixer taps.



18/10 Stainless Steel
Oliveri sinks are manufactured from genuine 18/10, 304 grade stainless steel, for optimum hygiene and durability.



Oliveri Logo
The Oliveri signature represents over 50 years of world class sinkware manufacture in Australia. If it's not an Oliveri, it's a compromise.



DU231 (DU232 REVERSE)



DU221 (DU222 REVERSE)



DU241 (DU242 REVERSE)

Duoform in the laundry



Economical in the Laundry
In the laundry, the Duoform's main tub holds a water-saving 35 litres whilst still being deep enough to fill large containers.



Practical in the Laundry
Fan-fluted drainers are practical in the laundry when hand-washing delicates.



Ergonomic
Duoform's shallower bowl is both practical and easy on your back for use in the Laundry.



Optional Bypass Plumbing
Fitting bypass behind washing machine is easy with Oliveri Laundry products. These items are not available from Oliveri.

Optional Accessories



AC03
Stainless Steel
Drainer Basket



AC16
Benchtop Drainer Tray



www.oliverisinks.com

Martini | At home behind the bar

Small spaces are a challenge for any sink. How do you retain style and practicality whilst maintaining suitability for small space applications? The Oliveri Martini is up to the challenge, with a compact, slimline design that fits into your bar, boat or caravan. And yet the Martini has all the style and features you've come to expect from every Oliveri sink.

MR502 shown with Mixer Tap PS113/1 as an optional extra.



Features



Slim Width
The Martini's narrow width makes it the perfect choice where space is at a premium.

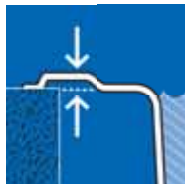

Low Profile Edge
The low profile edge design is pleasing to the eye and also helps to eliminate a potential dirt trap, making it both aesthetic and hygienic.



Large Capacity Bowl
For it's size, the Martini has a generous bowl. There's no need to compromise in your bar, boat or caravan.

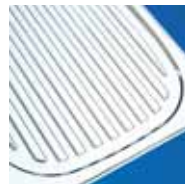

Effective Generous Drainer
The Martini's embossed drainer not only looks great but is also designed to drain away water more efficiently.



18/10 Stainless Steel
Oliveri sinks are manufactured from genuine 18/10, 304 grade stainless steel, for optimum hygiene and durability.



Oliveri Logo
The Oliveri signature represents over 50 years of world class sinkware manufacture in Australia. If it's not an Oliveri, it's a compromise.

Included Accessories



AC14
Basket Waste



AC02
¾ Bowl Colander



Accessories | Beyond a sink

The more you use your Oliveri sink the more you'll enjoy its sophisticated and functional design. The larger and deeper bowls make washing up easier and the impressive range of accessories transform any Oliveri sink into a total food processing centre. For instance, take the solid timber preparation board. In the morning you can use it for making sandwiches, at lunchtime it's simply perfect for preparing a salad, and when evening falls it even doubles as a stylish impromptu cheese board. Just one of the quality accessories that make Oliveri more than just a sink.



AC74

Timber Preparation Board
Fits into bowl to tip chopped vegetables into the colander.
Monet



AC15

Timber Preparation Board
Fits into bowl to tip chopped vegetables into the colander.
Petite



AC17

Timber Preparation Board
The knife friendly hardwood Timber Board fits over bowl.
Petite



AC01

Timber Preparation Board
The knife-friendly hardwood Timber Board fits over bowl.
Ultraform Duoform



AC50

Timber Preparation Board
The knife friendly hardwood finish has a unique cutaway design.
Solitaire



AC71

Stainless Steel Drainer Basket
Drain, rinse or stack. Can be used inside the bowl or on the drainer.
Monet



AC73

18/10 Stainless Utility Tray
Extends the versatility of your Monet by providing extra space.
Monet



AC03

Stainless Steel Drainer Basket
Drain, rinse or stack. Can be used inside the bowl or on the drainer.
All except Solitaire & Martini



AC53

Stainless Steel Utility Tray
Extends the versatility of your Solitaire by providing extra space.
Solitaire



AC51

Stainless Steel Drainer Basket
Drain, rinse or stack. Can be used inside the bowl or on the drainer.
Solitaire



AC72

'D' Colander
The perfect place to strain pasta or rinse vegetables and fits into bowl.
Monet



AC18

'D' Colander
The perfect place to strain pasta or rinse vegetables and fits into bowl.
Petite



AC02

3/4 Bowl Colander
The perfect place to strain pasta or rinse vegetables and fits into bowl.
Ultraform Martini



AC06

1/2 Bowl Colander
The perfect place to strain pasta or rinse vegetables and fits into bowl.
Petite Ultraform



AC16

Benchtop Drainer Tray
Protects your benchtop when draining dishes or defrosting food.
All except Solitaire & Martini

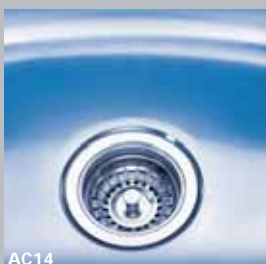

AC14

Basket Waste
Push down to seal, pull up to drain and strain. Remove to empty.
All sinks

Accessories suitable for all sinks in the range specified unless indicated by bowl size icon
See page 18 for bowl sizes.



www.oliverisinks.com

Tapware | The perfect partner

Oliveri tapware has been selected from the world's finest manufacturers. In order to wear the Oliveri signature it must be of the highest quality, elegant in design and functional. The taps are carefully chosen to complement the clean lines of your Oliveri sink while performing with the utmost reliability when connected to a variety of hot and cold water systems.

Versatile and practical

Rinse efficiently in spray mode; reach effortlessly with the extendable neck.



MV617/6 extendable spray head mixer

From washing vegetables to filling large pots, the Oliveri MV617/6 is a kitchen essential. This European made mixer tap features an extendable shower head that delivers either spray or stream at the flick of a button. It also includes a clever 'soft opening' device which reduces splashes. Like all Oliveri tapware, it is of the highest quality, elegant in design and functional, sourced from one of the world's finest manufacturers.

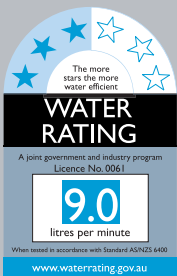
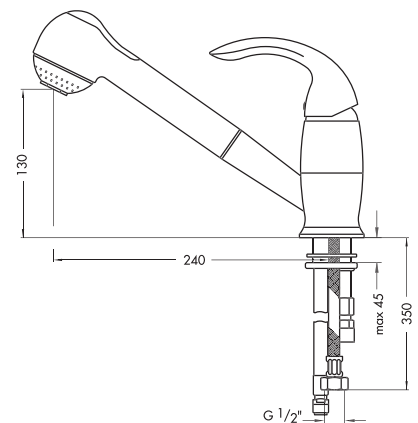

Oliveri mixer taps have a WELS 3 star water efficiency rating, 9.0 l/m.



MG513 mixer tap with gooseneck spout

This tall, elegant mixer tap has smooth curves to accompany the modern design of the larger Oliveri sinks. A generous spout height allows plenty of room to get the biggest roasting dish underneath, while the simple one-touch control lever responds instantly to your command. This European-made beauty will further enhance the finest Oliveri sinks.

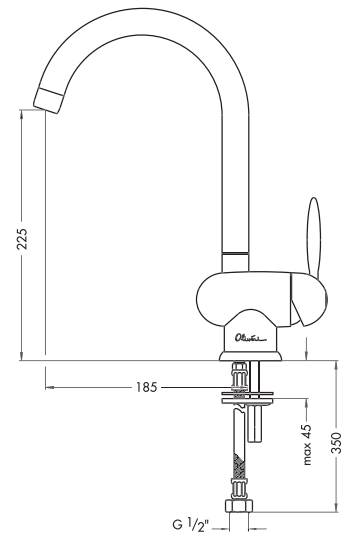

PS113/1 single lever sink mixer

This timeless design incorporates a generous reach swivelling spout with a handle that is smooth and light to operate as well as being easy to keep clean. Finished in bright chrome, this European-made mixer tap is very much at home on any Oliveri sink. The subtle Oliveri signature on the control handle is your sign of quality.

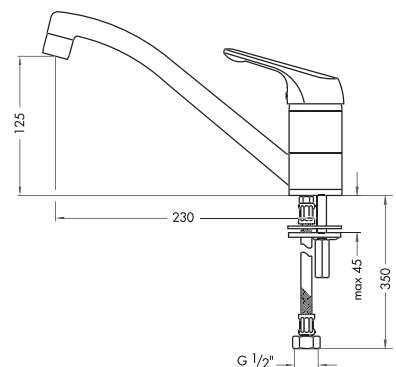

Oliveri Tapware is only available from selected outlets and is suitable for mains pressure water systems.



www.oliverisinks.com

Specifications & dimensions

35 Litre Mega Bowl
520 x 400 x 190mm deep
DU Sinks
35 Litre Capacity

Extra Capacity Bowl
350 x 420 x 180mm deep
MO Sinks
24 Litre Capacity

Round Bowl
420 x 180mm deep
LR Sinks
24 Litre Capacity

Large Capacity Bowl
330 x 400 x 180mm deep
PE Sinks
21 Litre Capacity

Deep Bowl
330 x 385 x 190mm deep
UF / DU Sinks
21 Litre Capacity

Main Bowl
330 x 385 x 155mm deep
UF Sinks
17 Litre Capacity

¾ Bowl
280 x 350 x 130mm deep
MO Sinks
11 Litre Capacity

¾ Bowl
280 x 330 x 130mm deep
PE Sinks
11 Litre Capacity

¾ Bowl
270 x 330 x 155mm deep
UF / MR Sinks
12 Litre Capacity

½ Bowl
215 x 350 x 130mm deep
MO Sinks
9 Litre Capacity

½ Bowl
200 x 290 x 130mm deep
PE / UF Sinks
7 Litre Capacity

Capacities are nominal

Monet

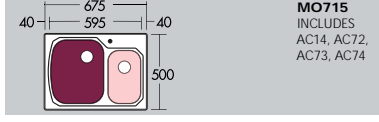
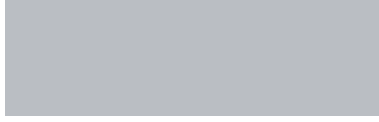
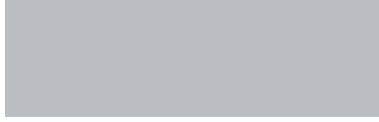
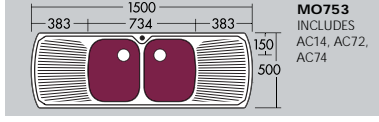
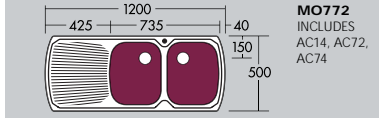
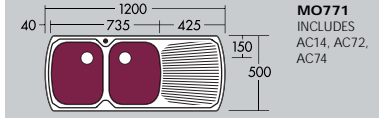
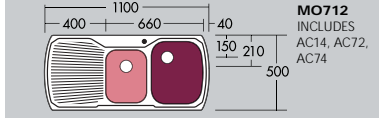
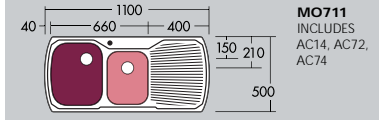
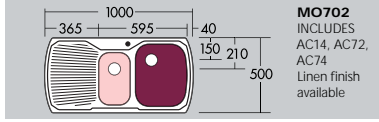
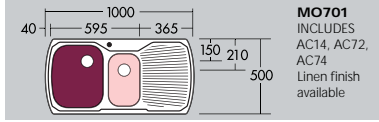
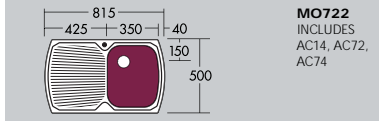
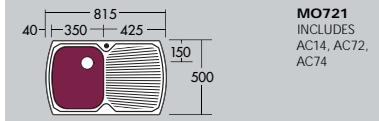

Petite

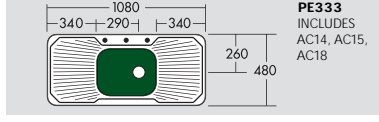
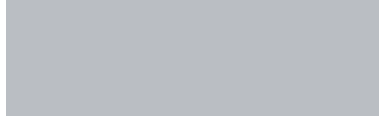
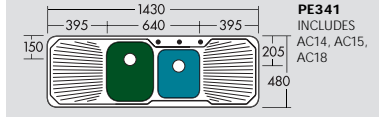
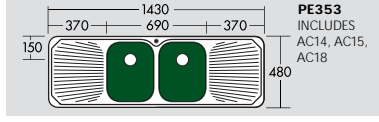
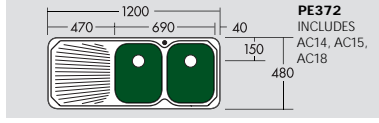
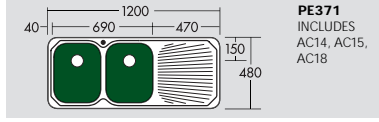
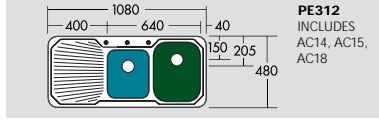
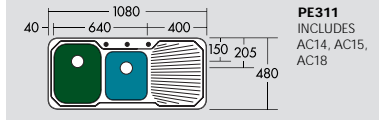
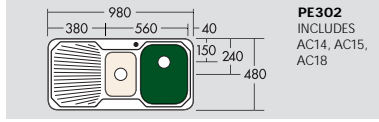
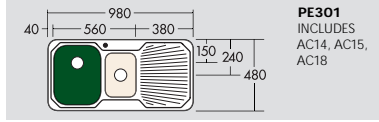
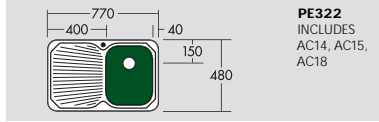
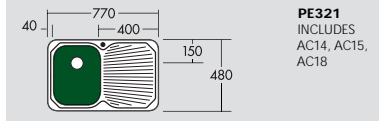

Ultraform

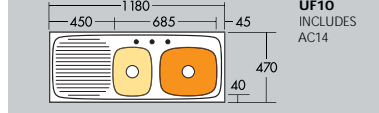
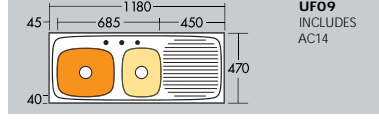
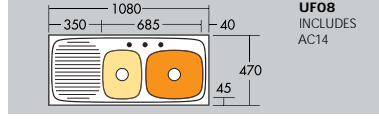
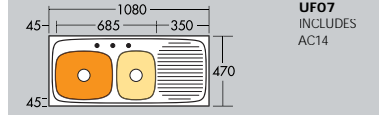
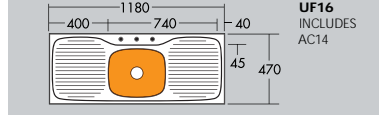
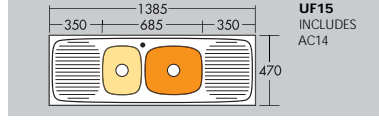
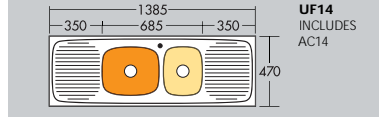
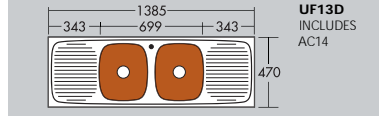
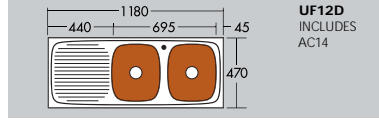
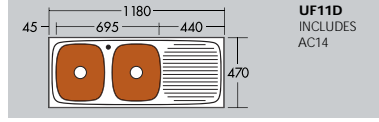
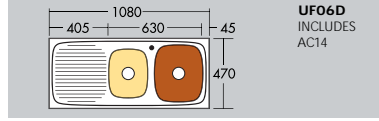
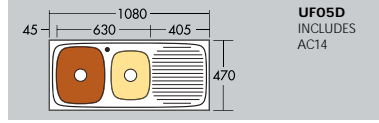
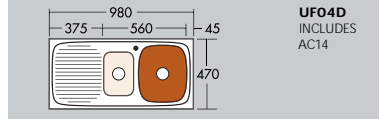
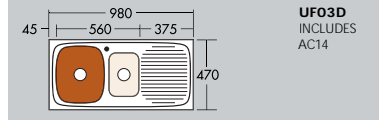
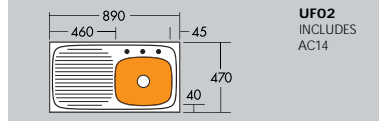
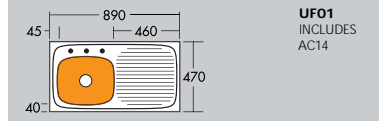

Duoform

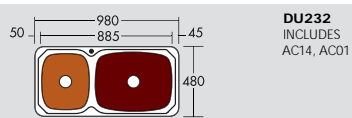
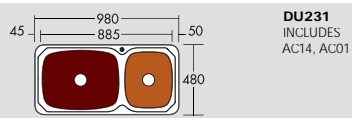
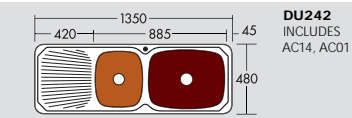
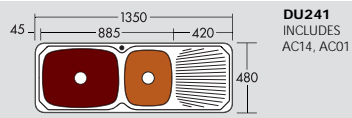
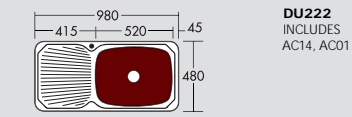
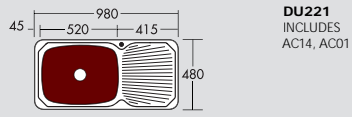

Solitaire

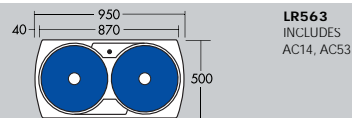
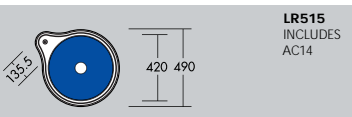
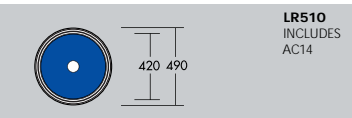
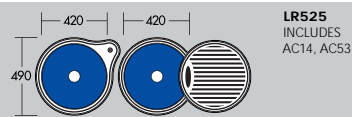
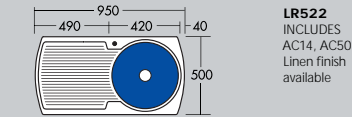
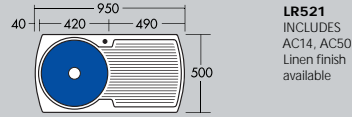

Martini

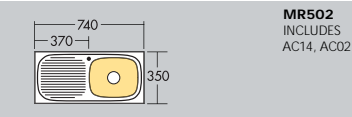
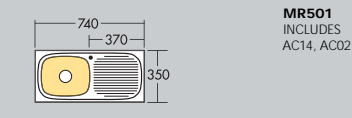

Cut Out Sizes

Sink Model	Size (mm)	Cut Out Size (mm)	Shipping Weight (kg)
Monet			
MO721, MO722	815 x 500	Full size cutout template included in Monet cartons	7
MO701, MO702	1000 x 500	Full size cutout template included in Monet cartons	9
MO711, MO712	1100 x 500	Full size cutout template included in Monet cartons	10
MO771, MO772	1200 x 500	Full size cutout template included in Monet cartons	10
MO753	1500 x 500	Full size cutout template included in Monet cartons	12
MO715	675 x 500	655 x 480	7
MO763	815 x 500	Full size cutout template included in Monet cartons	7
MO793	1060 x 500	Full size cutout template included in Monet cartons	10
Petite*			
PE321, PE322	770 x 480	750 x 460 x 75r	5.5
PE363	770 x 480	750 x 460 x 75r	6.5
PE301, PE302	980 x 480	960 x 460 x 75r	7
PE311, PE312	1080 x 480	1060 x 460 x 75r	7.5
PE333	1080 x 480	1060 x 460 x 75r	8
PE371, PE372	1200 x 480	1180 x 460 x 75r	8.5
PE353, PE341	1430 x 480	1410 x 460 x 75r	10
Ultraform			
UF01, UF02	890 x 470	870 x 450	4.5
UF03D, UF04D	980 x 470	960 x 450	6
UF05D, UF06D	1080 x 470	1060 x 450	6.5
UF07, UF08	1080 x 470	1060 x 450	6.5
UF11D, UF12D	1180 x 470	1160 x 450	7.5
UF09, UF10, UF16	1180 x 470	1160 x 450	7
UF13D, UF14, UF15	1385 x 470	1365 x 450	8.5
Duoform*			
DU221, DU222	980 x 480	960 x 460 x 75r	7
DU231, DU232	980 x 480	960 x 460 x 75r	7
DU241, DU242	1350 x 480	1330 x 460 x 75r	10
Martini			
MR501, MR502	740 x 350	720 x 330	4
Solitaire			
LR515, LR510 Top	490 diam	466 diam	4
LR510 Undermount	490 diam	454 diam	4
LR525 Topmount	490 diam x 2	466 diam x 2	8
LR521, LR522	950 x 500	For further details please refer to installation instructions.	10
LR563	950 x 500	For further details please refer to installation instructions.	9

*Full size cut out template included on Petite and Duoform sinks cartons.

NOTE: Not all sink models are stocked in countries outside Australia. Check availability with your local distributor (see back cover).



World Class Manufacturing

Over the years, the Oliveri signature has earned its reputation as a mark of excellence in design, function and durability. Overseas markets have also been impressed by the quality and innovative accessories that complement every Oliveri sink. Export sales continue to grow, further establishing Oliveri as one of the world's best stainless steel sinks.

The company began life as a general, domestic and metal fabricator in 1948. The founders pioneered the deep drawing technology in Australia, creating seamless, deep drawn stainless steel bowls.

Tasman Sinkware will continue to develop designs and styles suitable for any application where the highest standards are demanded.

Care & Maintenance

Oliveri sinks are manufactured from genuine 18/10, 304 grade stainless steel, for optimum hygiene and durability. However, no stainless steel sink was ever designed to do battle against hardened metal utensils or food processor blades, without incurring at least a few scratches.

The best prevention against scratching is to exercise a little extra care, or even to use one of Oliveri's accessory baskets when washing cutlery and the like.

To maintain the shine on your Oliveri sink, regular maintenance is recommended with any of the easy to obtain, non-abrasive stainless steel cleaners or metal polishes.

Genuine Oliveri

Beware of imitations as no one can match the quality and design of Oliveri sinks and accessories.

The Oliveri signature embossed into the stainless steel surface, as well as the distinctive Australian style packaging, ensures that your sink is a genuine Oliveri.

Solid Surface Collection

Oliveri's dedicated range of stainless steel sinks specially designed for solid surface benchtops.



Individually Inspected

Each Oliveri sink is individually inspected for quality of construction and finish.

Raw materials are sourced worldwide, and must satisfy the highest standards before being accepted into the manufacturing process.

Tasman Sinkware currently produce their sinks and tubs to "world standard" best practice. The company is Quality Endorsed and all products are manufactured to Standard ISO 9001-2000, your guarantee of quality.

Current designs reflect the most modern and innovative styles and are crafted to suit even the most discerning homeowner.



Head Office / Export Enquiries

Tasman Sinkware Pty Ltd

ABN 12 007 551 886
PO Box 2141 Regency Park
SA 5942 Australia
Phone 61 8 8348 6444
Fax 61 8 8348 6495
Website www.oliverisinks.com
Email sinkware@tasbuildpro.com.au

Australia

For more information call 1300 13 SINK (1300 13 7465) to be connected directly to your nearest brand or sales agent (not available from mobiles).



A division of Fletcher Building

Adelaide
(08) 8348 6444

Brisbane
(07) 3209 6679

Canberra
(02) 6280 5736

Darwin
(08) 8947 2101

Hobart
(03) 6275 2600

Tasman Sinkware North America*
1230 Railroad Street,
Corona, CA 92882
northamerica@oliverisinks.com

Melbourne
(03) 9587 1933

Perth
(08) 9446 5711

Sydney
(02) 9602 2322

Townsville
(07) 4775 4096

Wagga Wagga
(02) 6922 8600

New Zealand*
Dux Industries Ltd
0800 FORDUX (0800 367 389)
dux@dux.co.nz

Singapore*
Sim Siang Choon Ltd
6266 6632
sims@simsiangchoon.com

Hong Kong*
Deacon & Co Ltd
2369 6111
imports@deacon.com.hk
United Kingdom*

A.C.Toon Ltd
01246 223900
sales@actoon.co.uk
Canada*

Aquabross
(514) 381 4141

*Ranges, specifications and accessory options may vary outside Australia

Look for the brand with the blue dot



www.oliverisinks.com

Available from



® Registered trademark of Tasman Sinkware. Under its policy of ongoing product development Tasman Sinkware may from time to time change product specification without notice. WARNING: Products in this brochure and all literature pertaining to, are subject to Intellectual Property Protection. All dimensions given are approximate and should be checked prior to installation. Product colour reproduction is as near to actual as printing methods allow.