

PR-D9CL

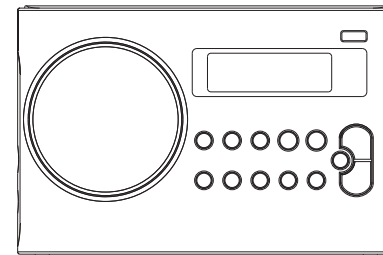

GB

Version 1

Table of contents

<i>Important safety instructions</i>	2-3
<i>Controls</i>	4-6
<i>Operating your radio – Search tuning AM / FM</i>	8
<i>Manual tuning – AM / FM / Setting up the tuning step increment</i>	9-10
<i>FM stereo / mono</i>	11
<i>Presetting stations / Recalling preset station</i>	12-13
<i>Setting the clock manually / Setting the time format</i>	14-15
<i>Display and Audio</i>	16
<i>Information</i>	17

Important safety instructions

1. Read and understand all safety and operating instructions before the radio is operated.
2. Retain instruction: The safety and operating instructions should be retained for future reference.
3. Heed warnings. All warnings on the appliance and operating instructions should be followed.
4. Follow all operations and use instructions.
5. Water and moisture: The appliance should not be used near water. Do not use near a bathtub, washbowl, laundry tub, kitchen sink, wet basement, swimming pool, etc.
6. Unplug the radio from the AC power outlet before cleaning. Use only a damp cloth for cleaning the exterior of the radio.
7. Do not place the radio on an unstable cart, stand, bracket or table. The radio may fall, causing serious personal injury and damage to the radio.
8. Ventilation: This radio should be situated so that its location or position does not interfere with its proper ventilation. For example, the radio should not be used on a bed, sofa, rug or other soft surfaces that may block the ventilation openings. It should not be placed in a built-in situation like a cabinet that may reduce air flow through the ventilation openings.
9. Power sources: The radio should be operated only from the type of power source indicated on the marking label. If you are not sure of the type of power supply to your home, consult your radio dealer or power company.
10. Mains adaptor: The mains adaptor should be positioned so it is not walked on, pinched, or items placed on top of it. Pay particular attention to wires at plugs, convenience receptacles, and the point where they exit from the unit. Unplug the mains adaptor by gripping the adaptor, not the wire. Operate the radio using only the current type of power source indicated. If you are not sure of the type of power supply to your home, consult your dealer or local power company.
11. Do not overload wall outlets or extension cords. This can result in a risk of fire or electrical shock. Never insert objects of any kind into the radio through opening. The objects may touch dangerous voltage points or short out parts. This could cause a fire or electrical shock.
12. If the radio is left unattended or unused for long periods of time, unplug it from the wall outlet. This will prevent damage caused by lightning or power line surges.
13. If the radio is left unattended and used for a long period of time, remove the batteries. The batteries may leak and damage furniture of your radio.

14. Do not attempt to service the receiver yourself. Removing the cover may expose you to dangerous voltage, and will void the warranty. Refer all servicing to authorized service personnel.
15. Never push objects of any kind into this radio through opening as they may touch dangerous voltage points or short-out parts that could result in a fire or electric shock. Never spill liquid of any kind of product.
16. The appliance should be serviced by qualified service personnel when:
 - A. The power supply cord or the plug has been damaged.
 - B. Objects have fallen or liquid had been spilled into the radio.
 - C. The radio has been exposed to rain or water.
 - D. The radio does not appear to operate normally or exhibits a marked change in performance.
 - E. The radio has been dropped, or the enclosure damaged.

Controls

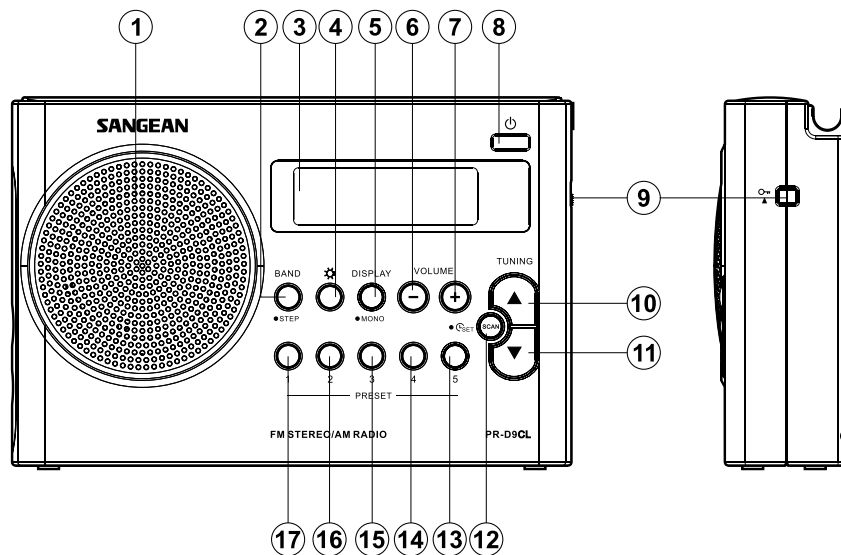

1. Speaker
2. Band / step button
3. LCD display
4. Backlight
5. Display / Stereo - mono
6. Volume down
7. Volume up
8. Standby
9. Lock switch

10. Tuning up
11. Tuning down
12. Scan / Clock time
13. Preset 5
14. Preset 4
15. Preset 3
16. Preset 2
17. Preset 1

Controls

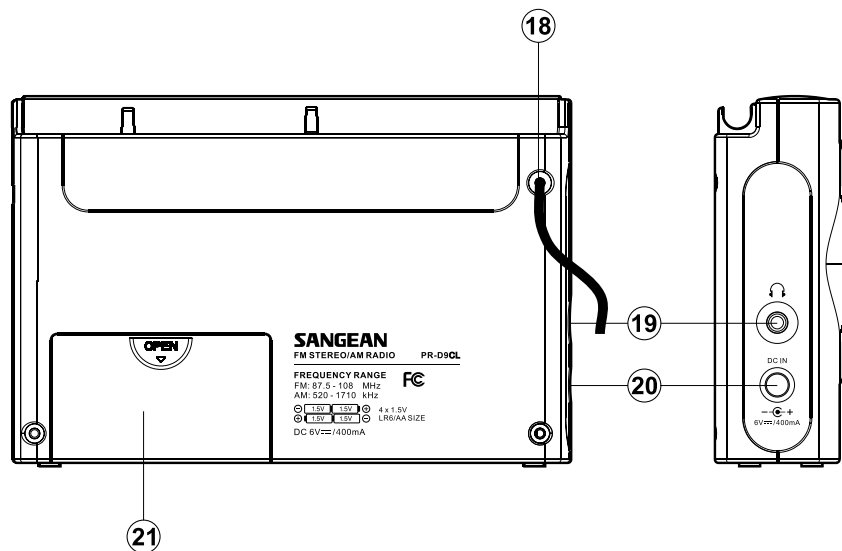

- 18. FM antenna
- 19. Headphone jack
- 20. DC in socket
- 21. Battery compartment

Display icon

- A. Stereo indicator
- B. Lock switch icon
- C. Volume icon
- D. Battery capacity indicator
- E. Memory preset
- F. FM 50kHz display
- G. Time indicator / Frequency display
- H. AM / FM band icon
- I. PM display

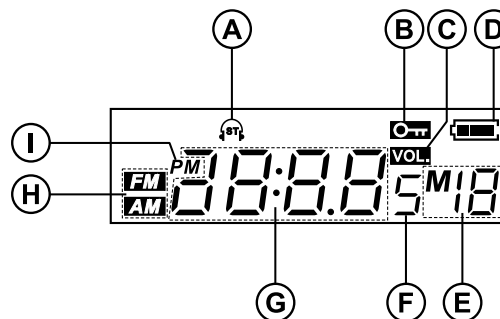

Using the weather alert radio for the first time

Battery operation

1. Remove the battery cover on the rear of the unit by pressing the catch.
2. Insert four UM-3 (AA size) batteries into the spaces in the compartment.
3. Take care to ensure all batteries are inserted with correct polarity as shown on the rear cabinet. Replace the battery cover.
4. Reduced power, distortion, "stuttering sound" and the battery icon flashing on the display are all signs that the batteries need replacing.
5. If the radio is not to be used for any extended period of time, it is recommended that the batteries are removed from the radio.

Using the AC power adaptor

The AC power adaptor required for this unit should be 6 volts DC at 0.4 A center pin positive.

Insert the adaptor plug into the DC socket on the left side of the radio. Plug the adaptor into a standard mains socket outlet.

Whenever the adaptor is used, the batteries are automatically disconnected. The AC adaptor should be disconnected from the main supply when not in use.

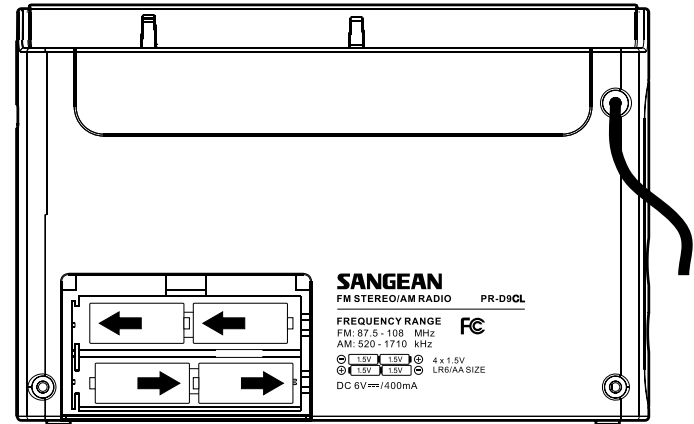

Operating your radio - Search tuning AM / FM

1. Fully extend the antenna above the radio. Press the Standby button to switch on your radio.
2. Press the Band button to select the required band.
3. Press the Scan button to start the search tuning. Your radio will scan in an upwards direction (low frequency to high frequency) and stop automatically when it finds a station of sufficient strength.
4. Press the Scan button or any other buttons (not included the Standby button) to stop the search tuning and you can listen to your desired station.
5. To find other stations, press and release the Tuning Up / Down buttons as before.
6. Adjust the volume control by pressing the Volume up/down button to the required setting.

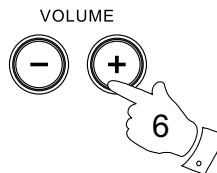
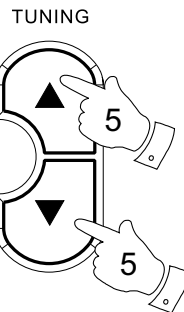
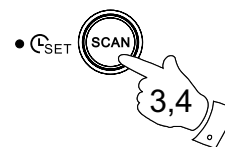
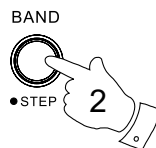
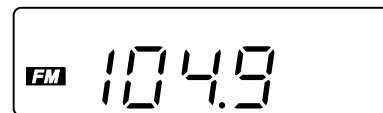
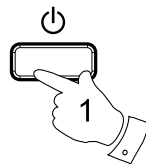

Manual tuning – AM / FM

1. Press the Standby button to switch on your radio.
2. Press the Band button to select the required band. Fully extend the antenna for best reception.
3. Press and release the Tuning up/down button to tune to a station.
The FM frequency will change in steps of 100/200kHz and AM frequency will change in steps of 9/10kHz.
4. When the waveband end is reached the radio will recommence tuning from the opposite waveband end.
5. Set the Volume using the Volume Up/Down buttons to the desired settings.

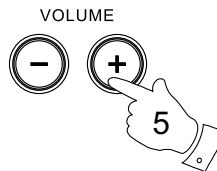
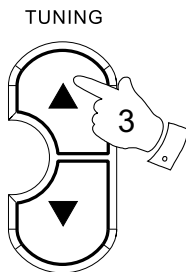
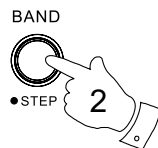
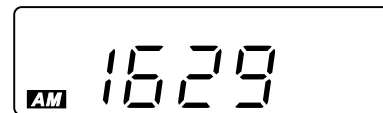
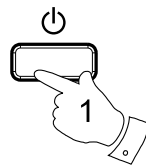

Setting up the tuning step increment

1. Make sure your radio is in power off mode.
2. Press and hold the Band/step button until the FM tuning step setting begins to flash.
3. Press the Tuning Up / Down buttons to select either 100kHz or 200kHz for FM radio, and press and release the Band/step button to confirm the setting. And the AM tuning step setting will begin to flash.
4. Press the Tuning Up / Down buttons to select either 9kHz or 10kHz for AM radio, then press and release the Band/step button to confirm the setting.

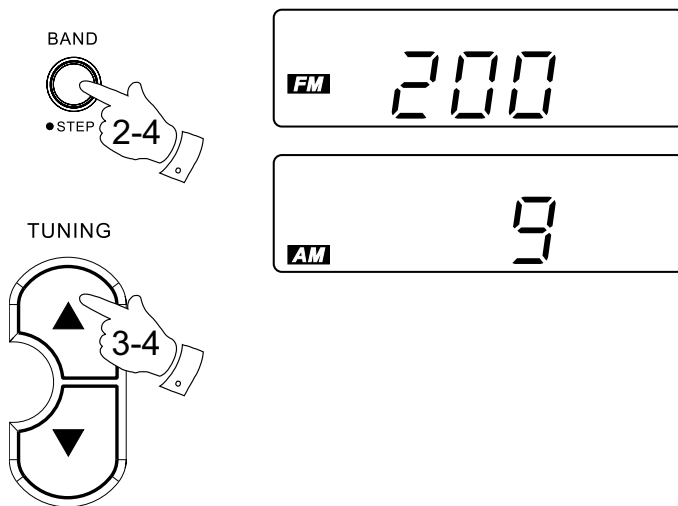

FM stereo (Auto) / mono

If the FM radio station being listened to has a weak signal some hiss may be audible. It is possible to reduce this hiss by forcing the radio to play the station in mono rather than stereo.

1. Press the Step/Band button to select the FM band and tune to the required FM stations as previously described.
2. The display will show the current setting of the station being listened to. The stereo indicator will show on the LCD display when the FM station tuned to has stereo signal.
3. If the setting is Auto, press and hold the Display/St. button to switch to Mono mode to reduce the hiss. The stereo indicator will disappear from the display.
4. To return to Auto (stereo) mode press and hold the Display/St. button again, so that the radio will switch back to Auto mode.

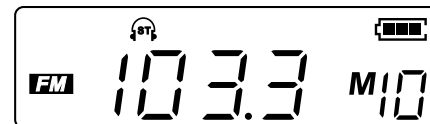
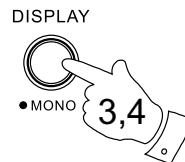
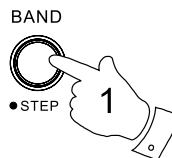

Presetting stations

You may store your preferred AM/FM radio stations to the preset stations (1 to 5). The procedure for setting preset Stations is described below. Note that the radios for AM and FM are saved together in the preset stations so there are 10 of them. Your preset stations are preserved in the event of a power failure.

1. Press the Standby button to switch on your radio.
2. Tune to the required station as previously described.
3. Press and hold the required Preset button (1-5) until the display shows 'M1' for example after the frequency. The station will be stored using the preset number. Repeat this procedure for the remaining presets as you wish.
4. Preset stations which have already been stored may be overwritten by following the above procedure if required.

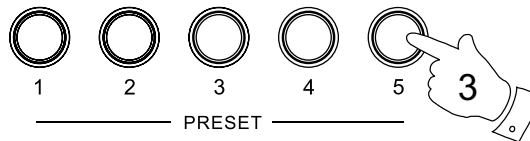
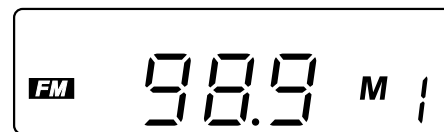
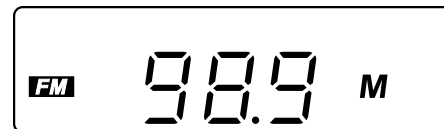
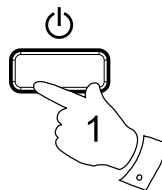

Recalling a preset station

1. Press the Standby button to switch on your radio.
2. Select the required waveband by pressing the Step / Band button.
3. Press and release the required Preset button to allow your radio to tune to one of the stations stored in the preset memory.

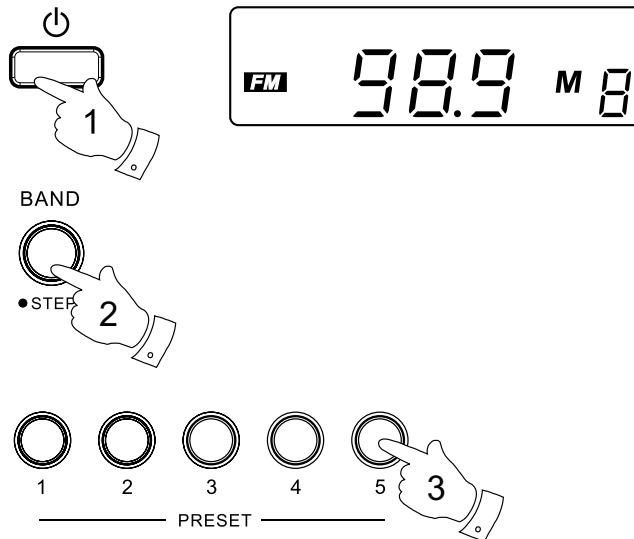

Clock setting

1. Press and hold the clock time button until the radio beeps once and the hour digits of time setting begins to flash.
2. Press the Tuning Up / Down button to adjust the hour setting as required.
3. Press and release the clock time button to enter the setting, and the minute digits of time setting will begin to flash. Press the Tuning Up / Down button to adjust the minute setting as required.
4. Press and release the clock time button again to finish the setting.
Your radio clock is now set.

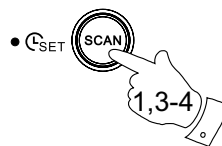

TUNING

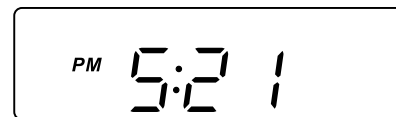
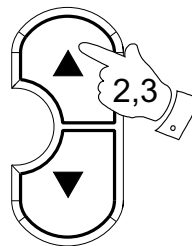

Setting the time format

The clock display used in stand-by mode and on the playing mode screens can be set to 12 or 24 hour format.

1. With your radio switched off, press and hold the Band / step button until the radio beep once and the display will show Software version.
2. Keep pressing and holding the Band / step button, FM tuning step setting will flash. Press and release the Band / step button to enter AM tuning step setting, press and release the Band / step button to enter the time format setting.
3. Press the Tuning up / down to select either 12 or 24 hour format.
4. Press and release the Band / step button to confirm the setting.

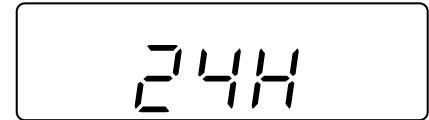
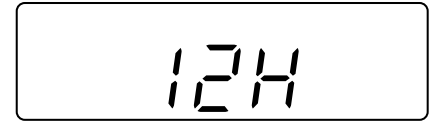
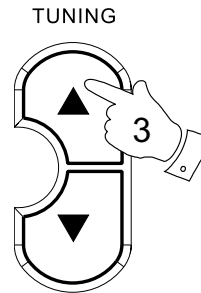
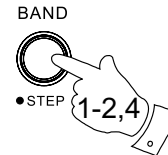

Display and Audio

Brightness control

The brightness of the display can be adjusted when the radio is in Standby mode and when it is in use. Press the Backlight button and the display will illuminate for approx. 10 seconds. To turn off the backlight, press the Backlight button again.

Headphone socket

A 3.5mm stereo headphone socket is provided on the left hand side of your radio for use with headphones. Inserting a plug automatically mutes the internal speaker.

IMPORTANT:

Excessive sound pressure from earphones and headphones can cause hearing loss.

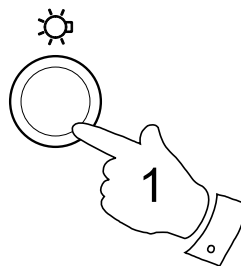

Information

Specifications

Power Requirements

Mains DC in 6V / 0.4 A

Frequency Range

FM 87.5 – 108 MHz

AM 520 – 1710 kHz (USA version)

Battery

4 X 1.5V Size "AA" / UM-3 / LR6

Circuit Features

Loudspeaker 2.25" 8 ohm full range

Output Power 1 Watt (max)

Headphone socket 3.5mm dia.

Aerial System FM Rubber antenna / FM Wire antenna