



Parts List

Latch A 	Exterior Assembly 	Interior Assembly 	
Latch B "B" is not included. If needed, please contact Kwikset to order a drive-in latch for your lock.		For Latch / Strike Strike 03809 	For Lock SmartKey Tool 69316
Adapter Ring 	Mounting Plate 	46780 	48654
Batteries 	Keys 		

ENGLISH

SMARTCODE 914

TOUCHPAD ELECTRONIC DEADBOLT

Installation and User Guide

Required tools

Ruler
Phillips head screwdriver

Kwikset
1-866-863-6584
www.kwikset.com

1 Begin with your smart home app

If you will be using a smart home app with your lock, download the app and set up your controller or hub before proceeding further with lock installation.

2 Prepare the door and check dimensions

If drilling a new door, use the supplied template and the complete door drilling instructions available at kwikset.com/doorprep

A Make sure your door is compatible. If you have a standard deadbolt mounted separately from the handle below it, your door is compatible.

B Remove your existing deadbolt from your door.

C Measure to confirm that the hole in the door is either 2-1/8" (54 mm) or 1-1/2" (38 mm).
Note: Additional door preparation may be required for doors with 1-1/2" (38 mm) holes. Consult the deadbolt drilling instructions at kwikset.com/doorprep

D Measure to confirm that the backset is either 2-3/8" or 2-3/4" (60 or 70 mm).

E Measure to confirm that the hole in the door edge is 1" (25 mm).

F Measure to confirm that the door is between 1-3/8" and 2" (35 mm and 51 mm) thick.

3 Install the latch and strike

For Latch / Strike Bag

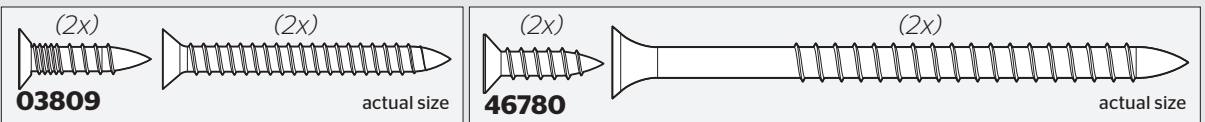

A Extend the latch bolt.

B Hold the latch in front of the door hole, with the latch face flush against the door edge.

C Is the D-shaped hole centered in the door hole?

YES D-shaped hole No adjustment is required. Proceed to next step.	NO D-shaped hole Rotate latch face as shown to extend latch.
---	---

D Install the latch.

E Install the strike on the door frame.

⚠ Make sure the hole in the door frame is drilled a minimum of 1" (25 mm) deep.

Longer screws install closest to the door jamb.
46780 (4x) For Latch/Strike Bag
door frame



4 Install the exterior keypad

For Lock Bag

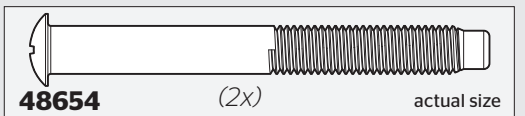

A What is the diameter of the hole in the door?

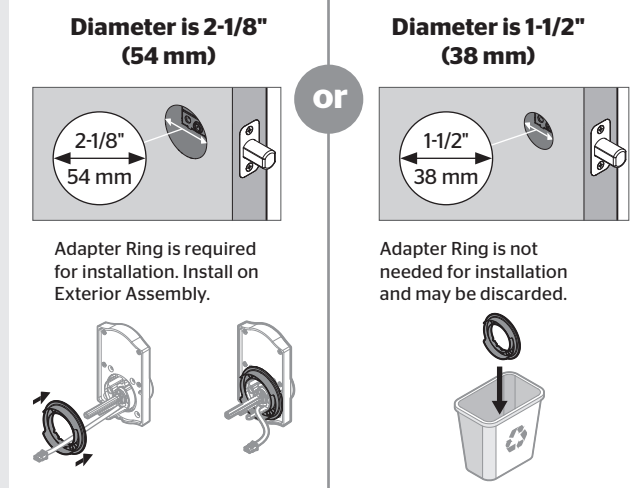

B Locate the screws for step 4C and keep them within reach.

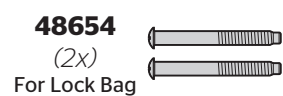

C Install the exterior keypad and mounting plate.

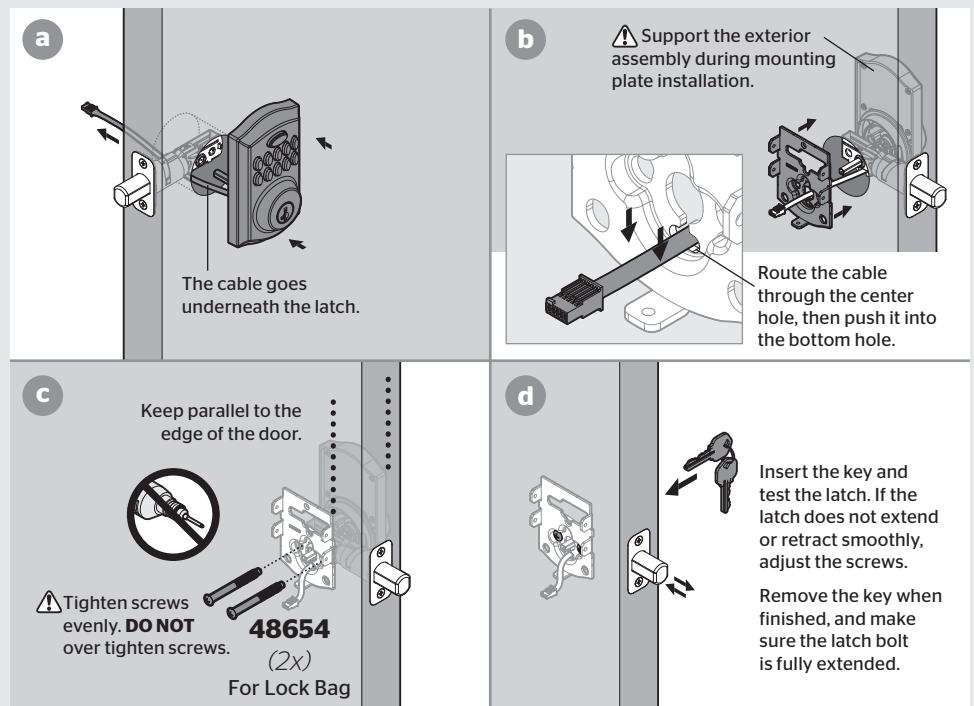

5 Install the interior assembly

For Lock Bag



A Remove the interior cover and battery pack from the interior assembly.

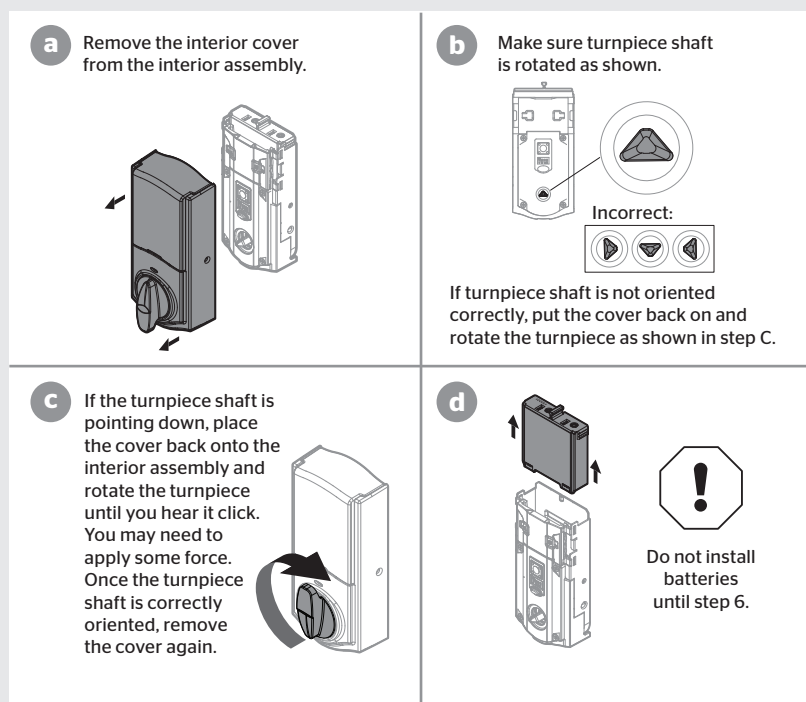

B Install the interior assembly onto the mounting plate.

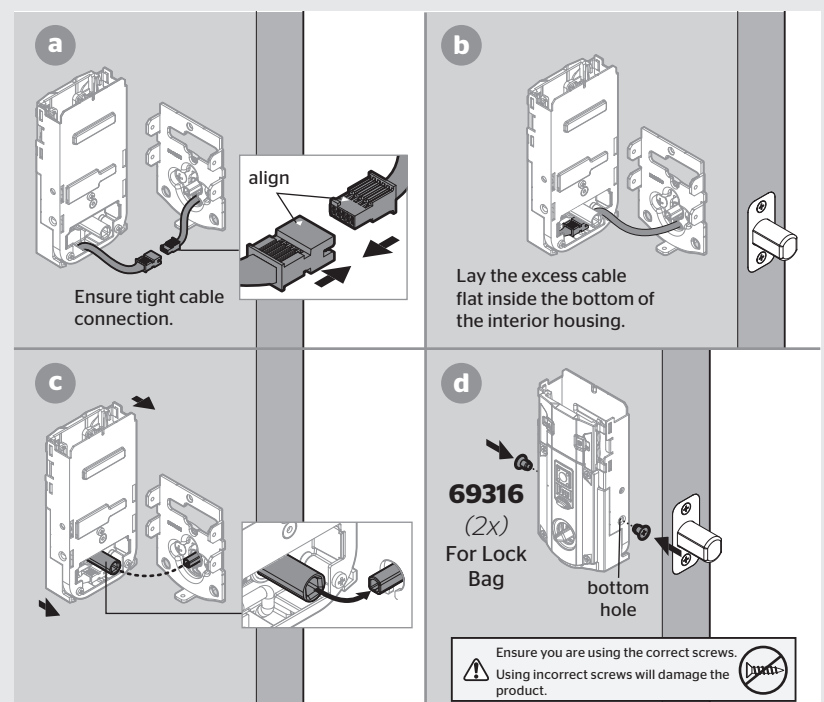

6 Install the batteries and perform the door handing process

This step will teach your lock the orientation of your door and is crucial to lock operation.

A Install 4 AA batteries in the battery pack.

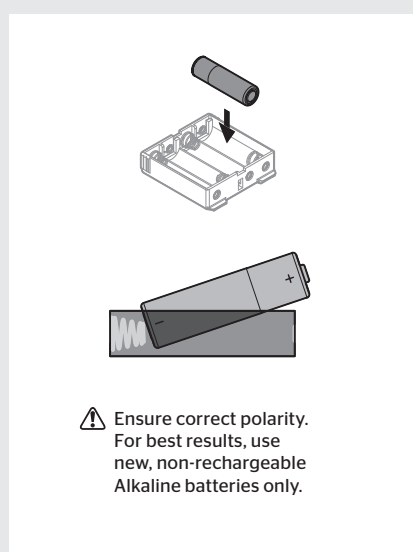

B With the door open, press and HOLD the "Lock" button while installing the battery pack.
Hold the button until the latch bolt starts moving on its own.

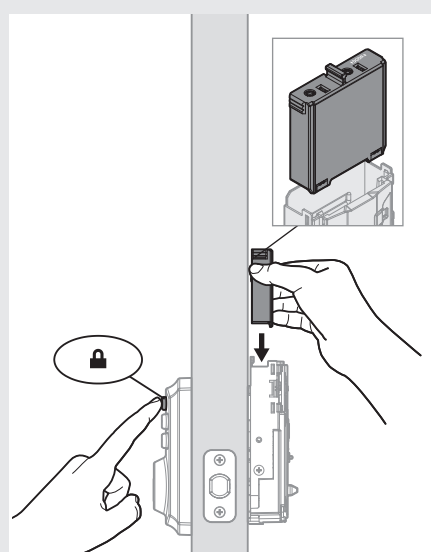

C The latch will retract and extend to learn the orientation of the door.

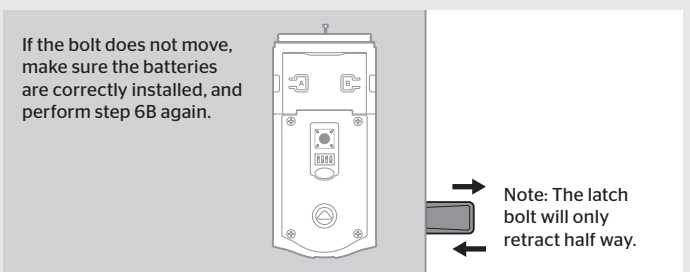

D The Status LED will indicate success or failure.

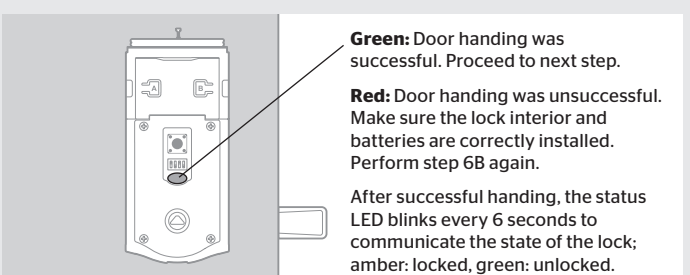

7 Pair the lock with your smart home system

A Initiate the pairing process through your smart home system (either through your smart home app, at your panel, or at your controller or hub).
Refer to your smart home system instructions for more information.

B You may be prompted by your smart home system to scan the QR code on the interior assembly. If not, proceed to step C.

C When prompted by your smart home system to initiate pairing at the lock, press button "A" on the lock interior four times.

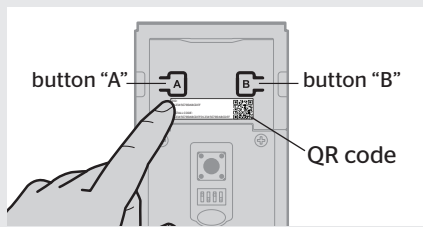

D If the pairing process is successful, re-name the lock in your system (if applicable).

E If the pairing process is unsuccessful, press button "B" nine times.
Perform steps 7A-7D again.
If still unsuccessful, follow your smart home system's instructions to remove (exclude/unpair) the lock from any other network. Then perform steps 7A-7D again.

8 Add user codes (30 maximum)

It is recommended that you add and delete all user codes through your smart home system.
If your system does not allow this, codes may be added directly to the lock as shown here.

A Programming information

Mastercode: For enhanced security, a mastercode may be used when adding and deleting user codes. For more information about the mastercode, download the SmartCode 914 Programming and Troubleshooting Guide at www.kwikset.com.

Programming Timeout: During programming, if no button is pressed for five seconds, the system will time out (indicated by three beeps and a red flashing keypad), and you will need to restart the procedure.

B Make sure the door is open. Press the "Program" button once.

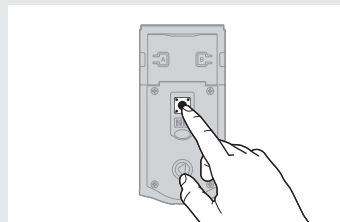

C Enter a new user code. A total of 30 user codes may be programmed.

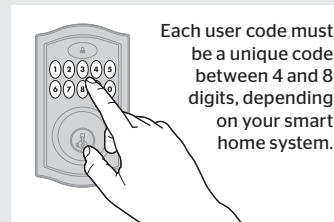

Each user code must be a unique code between 4 and 8 digits, depending on your smart home system.

D Press the "Lock" button once.

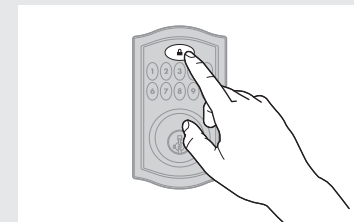

E What lights and sounds does the lock produce?

One green flash with one beep

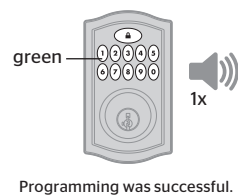

Programming was successful.

OR

Three red flashes with three beeps

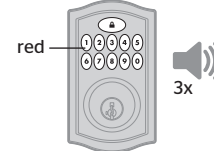

Programming was unsuccessful.

Move swiftly through programming, as the system will time out if no button is pressed for five seconds.

Make sure the user code is not a duplicate and that it is between 4 and 8 digits during your next attempt.

Make sure the lock has room for an additional code. If all user code positions are filled, delete a code to make room for this one.

*Beeping sound will only be heard if switch #3 (on the lock interior) is in the on position.

9 Test the lock and check door alignment

A With the door open, press the "Lock" button. Confirm that the door locks.

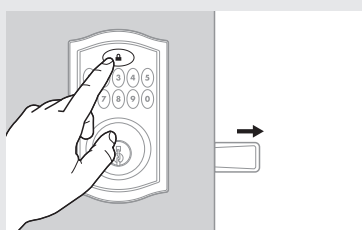

B Enter the user code(s) added in the previous step. Confirm that the door unlocks.

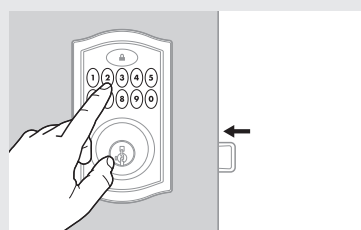

C Close the door. Press the "Lock" button. Confirm that the door locks smoothly without error.

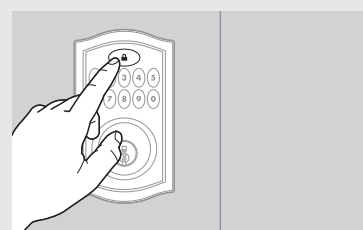

D If your door does not lock smoothly, make sure you replaced your previous latch and strike with those supplied in the box.

If you still experience locking errors, call Kwikset Support to order a Warped Door Service Kit.

Kwikset Support: 1-866-863-6584

10 Install the interior cover

For Lock Bag



Important Information about the interior cover

The window on the interior cover is locked by default to prevent someone from tampering with your lock's settings.

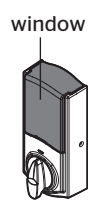

If you wish to unlock the window, you can slide it up for more convenient access to the programming buttons while the cover is installed.

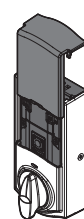

To unlock the window, remove the security screw.

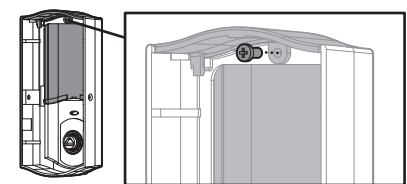

Cover Installation

a Install cover.

Note: You may need to rotate the turnpiece to align with the turnpiece shaft.

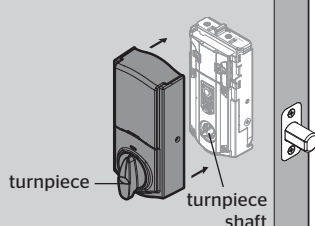

b Install screws.

69316 (3x)
For Lock Bag

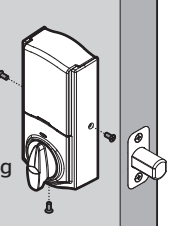

Battery Pack Access

If the window is unlocked, remove the window to access the battery pack.

If the window is locked, remove the interior cover and screws to access the battery pack.



SmartCode at a Glance

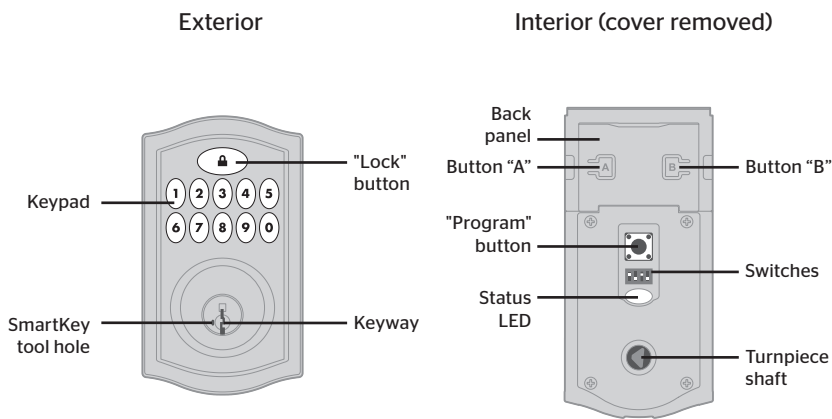

Note: When the cover is removed, the turnpiece shaft can be used to manually lock and unlock the door.

System Alerts

Alert	Reason	Solution
Keypad flashes red once with one beep*	One incorrect code entered.	Re-enter code.
Keypad flashes red three times with three beeps*.	No user code programmed.	Program at least one user code.
	Programming timeout after five seconds.	Attempt programming procedure again.
	Unsuccessful programming.	
Keypad flashes red 15 times with 15 beeps*	Three incorrect codes entered within one minute.	Re-enter code after 60 second keypad lockout.
Keypad flashes red with fast beeping sound for three to four seconds.	Low battery.	Replace batteries.
Keypad flashes red with continuous beeping sound for two seconds.	Door jammed while attempting to lock.	Manually re-lock door. If needed, reposition strike.
Lock beeps continuously.	Interior assembly is disconnected from exterior.	Remove battery pack, reconnect the interior to the exterior, then reinstall battery pack.

*Beeping sound will only be heard if switch #3 is on.

Switches and Status LED colors

These features can be adjusted in some smart home apps. Once the associated functions are set by Zigbee, the setting of switches #1, 2 & 3 no longer affect the lock operation until factory reset.

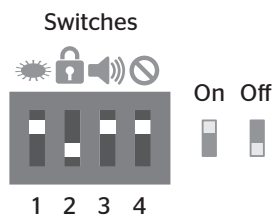

Switch	Function
1	Door lock status LED blinks every 6 seconds
2	Lock automatically re-locks door 30 seconds after unlocking. Disabled if no codes are programmed.
3	Audio
4	Not used.

Color	Lock Status
Blinking green	Unlocked
Blinking amber	Locked
Blinking red	Low battery
Solid red	Door handing process did not work properly. See the online Programming and Troubleshooting Guide.

Troubleshooting

A complete SmartCode 914 Programming and Troubleshooting Guide is available at www.kwikset.com.

Deleting a single user code (manually at the lock)

Note: All codes may be deleted at once if the mastercode is enabled. For more information about the mastercode, consult the SmartCode 914 Programming and Troubleshooting Guide at www.kwikset.com.

1 Keep door open. Press "Program" button once.	2 Press "Lock" button once.	3 Enter user code to be deleted.	4 Press "Lock" button once.
5 Re-enter user code.	6 Press "Lock" button once.	If unsuccessful Make sure to enter the same valid code in steps 3 and 5.	⚠ Test code While the door is open, test the user code to make sure it no longer unlocks the door.

If no button is pressed for five seconds, the system will time out, and you will need to restart the procedure.

Factory Reset

A factory reset will delete all codes associated with the lock, and it will remove it from your smart home system.

1 Remove battery pack.	2 Press and HOLD the "Program" button while reinserting the battery pack. Keep holding the button for 30 seconds until the lock beeps and the status LED flashes red.
3 Press the "Program" button once more. When the LED flashes green and you hear one beep, the lock has been reset.	4 Perform the door handing process again to teach the lock the orientation of the door, pair the lock with your smart home system, and add user codes to your lock.

Network Information

ZigBee System Notes

ZigBee is a "Wireless mesh network," and results may vary based on building construction and communication path, with 35+ feet being typical installed distance in a standard home environment and 250 feet+ when the lock has a clear line of sight with the smart home controller or hub. It may be necessary to install additional ZigBee devices to enhance the communication path between the lock and controller/hub for a more robust ZigBee network.

Removing the lock from the network

Press button "B" on the lock interior nine times.

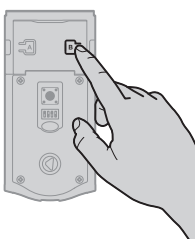

SmartKey Re-Keying

Re-key the lock to work with your existing key. See the supplied SmartKey Re-key instructions for more information.

Note: If Auto-Lock is enabled (see "Switches and Status LED Colors"), remove the battery pack before re-keying your lock.

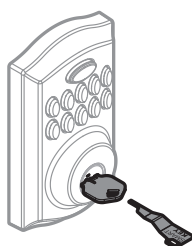

Important Safeguards

1. Read all instructions in their entirety.
2. Familiarize yourself with all warning and caution statements.
3. Remind all family members of safety precautions.
4. Protect your user codes and mastercode.
5. Dispose of used batteries according to local laws and regulations.

⚠ CAUTION: Prevent unauthorized entry. Since anyone with access to the back panel can change the user codes, you must restrict access to the back panel and routinely check the user codes to ensure they have not been altered without your knowledge. The use of a mastercode can help protect your system's settings.

⚠ WARNING: This Manufacturer advises that no lock can provide complete security by itself. This lock may be defeated by forcible or technical means, or evaded by entry elsewhere on the property. No lock can substitute for caution, awareness of your environment, and common sense. Builder's hardware is available in multiple performance grades to suit the application. In order to enhance security and reduce risk, you should consult a qualified locksmith or other security professional.