

OTIC[®]

Bluetooth Turntable

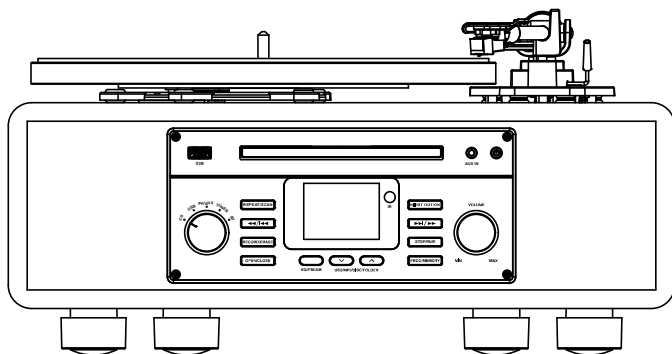

Model: JC-9021

Instruction Manual

WARNING



CAUTION: TO REDUCE THE RISK OF ELECTRIC SHOCK, DO NOT REMOVE COVER (OR BACK). NO USER SERVICEABLE PARTS INSIDE. REFER SERVICING TO QUALIFIED SERVICE PERSONNEL.



DANGEROUS VOLTAGE: The lightning flash with arrowhead symbol within an equilateral triangle is intended to alert the user to the presence of uninsulated dangerous voltage within the product's enclosure that may be of sufficient magnitude to constitute a risk of electric shock to persons.



ATTENTION: The exclamation point within an equilateral triangle is intended to alert the user to the presence of important operating and maintenance (servicing) instructions in the literature accompanying the appliance.



WARNING: Invisible laser radiation when open and interlock failed or defeated. Avoid direct exposure to laser beam.



This equipment is a Class II or double insulated electrical appliance. It has been designed in such a way that it does not require a safety connection to electrical earth.

FCC Warning

This device complies with part 15 of the FCC Rules. Operation is subject to the following two conditions: (1) This device may not cause harmful interference, and (2) this device must accept any interference received, including interference that may cause undesired operation.

Note: This equipment has been tested and found to comply with the limits for a Class B digital device, pursuant to part 15 of the FCC Rules. These limits are designed to provide reasonable protection against harmful interference in a residential installation. This equipment generates, uses and can radiate radio frequency energy and, if not installed and used in accordance with the instructions, may cause harmful interference to radio communications. However, there is no guarantee that interference will not occur in a particular installation. If this equipment does cause harmful interference to radio or television reception, which can be determined by turning the equipment off and on, the user is encouraged to try to correct the interference by one or more of the following measures:

- Reorient or relocate the receiving antenna.
- Increase the separation between the equipment and receiver.
- Connect the equipment into an outlet on a circuit different from that to which the receiver is connected.
- Consult the dealer or an experienced radio/TV technician for help.

Note: The Grantee is not responsible for any changes or modifications not expressly approved by the party responsible for compliance. Such modifications could void the user's authority to operate the equipment.

The device has been evaluated to meet general RF exposure requirement.

To maintain compliance with FCC's RF exposure guidelines, the distance must be at least 20 cm between the radiator and your body, and fully supported by the operating and installation.

Important Safety Instructions

1. Read these instructions – All the safety and operating instructions should be read before this product is operated.
2. Keep these instructions – The safety and operating instructions should be retained for future reference.
3. Heed all warnings – All warnings on the appliance and in the operating instructions should be adhered to.
4. Follow all instructions – All operating and use instructions should be followed.
5. Do not use this apparatus near water – The appliance should not be used near water or moisture – for example, in a wet basement or near a swimming pool, and the like.
6. Clean only with a dry cloth.
7. Do not block any ventilation openings. Install in accordance with the manufacturer's instructions.
8. Do not install near any heat sources such as radiators, heat registers, stoves, or other apparatus (including amplifiers) that produce heat.
9. Protect the power cord from being walked on or pinched particularly at the plugs, power outlets, and at the point where they exit from the apparatus.
10. Only use attachments/accessories specified by the manufacturer.
11. Use only with the cart, stand, tripod, bracket, or table specified by the manufacturer, or sold with the apparatus. When a cart or rack is used, use caution when moving the cart/apparatus combination to avoid injury from tip-over. 
12. Unplug the apparatus during lighting storms or when unused for long periods of time.
13. Refer all servicing to qualified personnel. Servicing is required when the apparatus has been damaged in any way, such as power supply cord or plug is damaged, liquid has been spilled or objects have fallen into the apparatus has been exposed to rain or moisture, does not operate normally, or has been dropped.
14. The mains plug is used as disconnect device, the disconnect device shall remain readily operable.
15. **WARNING:** To reduce the risk of fire or electric shock, do not expose this apparatus to rain or moisture. The apparatus shall not be exposed to dripping or splashing and that no objects filled with liquids, such as vases, shall not be placed on apparatus.
16. The use of the equipment in moderate climate.
17. The ventilation should not be impeded by covering the ventilation openings with items, such as newspapers, tablecloths, curtains, etc.
18. Do not place open flame sources, such as lighted candles, on the apparatus.
19. The symbol with \sim indicates AC voltage.
20. **CAUTION:** These servicing instructions are for use by qualified service personnel only. To reduce the risk of electric shock do not perform any servicing other than that contained in the operating instructions unless you are qualified to do so.

PRODUCT OVERVIEW

Turntable

1. Turntable Platter
2. Turntable Spindle
3. Counterweight
4. Cue Lever
5. Speed Indicator
6. Speed Selector
7. Hold Down Clip
8. Tone Arm
9. Cartridge

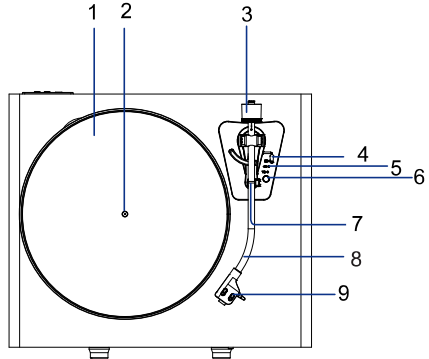

Front Panel

1. USB Port
2. Disc tray
3. Display
4. Remote sensor
5. AUX IN Jack
6. Power Button
7. Function Knob
8. Repeat/Scan Button
9. Rewind/Previous Button
10. Open/Close Button
11. Record/Erase Button
12. EQ/FM/AM Button
13. USB/MP3/DISC/FOLDER Buttons
14. Play/Pause/Bluetooth OUT/OK Button
15. Fast Forward/Next Button
16. Program/Memory Button
17. Stop/Pair Button
18. Volume Knob

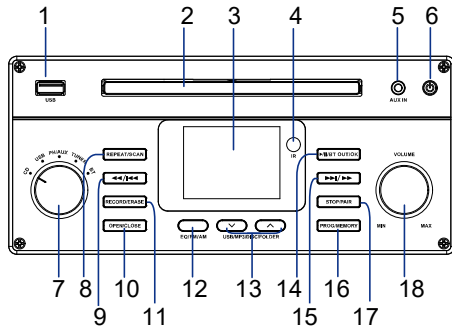

Back Panel

1. FM Antenna
2. DC IN Jack
3. Line Out Jack

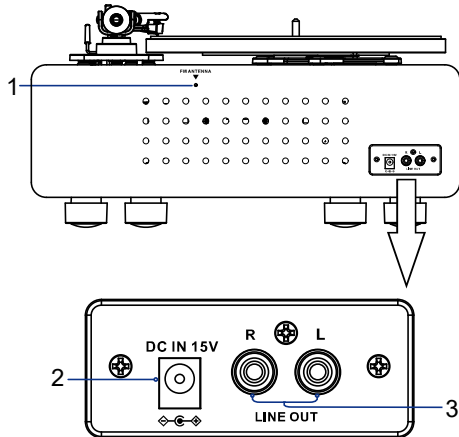

REMOTE CONTROL

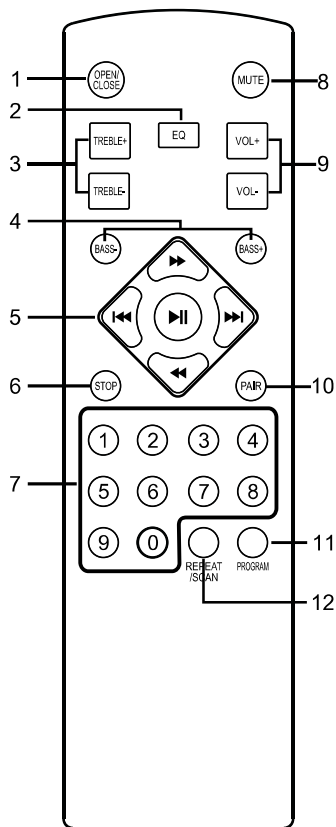

1. **OPEN/CLOSE button**
Open or close the Disc tray.
2. **EQ button**
Change the EQ effects(NOR/ROCK/CLASS/
GAME/MOVIE/NEWS/POP/JAZZ).
3. **TREBLE+/- buttons**
Adjust the treble effect.
4. **BASS+/- buttons**
Adjust the bass effect.
5. **◀◀ button**
Skip to previous track.
▶▶ button
Skip to next track.
◀◀ button
Press and hold to rewind to the part you want to listen.
▶▶ button
Press and hold to fast forward to the part you want to listen.
▶|| button
Play or pause the track.
6. **STOP button**
Stop the tracks.
7. **NUMERIC buttons**
Enter number to choose the desired track.
8. **MUTE button**
Press to mute the unit, press again to resume.
9. **VOL+/- buttons**
Adjust the volume.
10. **PAIR button**
Press to disconnect the Bluetooth device.
11. **PROGRAM button**
Press to program playback sequences.
12. **REPEAT/SCAN button**
Repeat the tracks; search and store stations in Radio mode.

Note: The remote control does not always function in all modes.

SETUP & BASIC OPERATION

Essential Setup

1. Unpack the unit and remove all packaging materials.
2. Place the unit on a flat and level surface. The selected location should be stable and free from vibration.
3. Plug the power adaptor into the electrical outlet and connect another end to the back of the unit.
4. Press the **⏻** Button on the upper right corner of the front panel. The display will light up and playback mode will appear on the display.
5. When the unit is playing music, the playback status will appear on the display.

Panel Control

- Press the **⏸/BT OUT/OK** button to pause the playback, press it again to resume playback.
- Press the **⏮/⏪** or **⏩/⏭** button to skip to previous or next track.
- To search for a part of track: press and hold the **⏮/⏪** or **⏩/⏭** button and release it when the part you want is found.
- Search for a folder, press the **USB/MP3/DISC/FOLDER** Buttons to choose the folder.
- Press the **STOP/PAIR** button to stop playing.
- Press the **EQ/FM/AM** button on unit to change the EQ effects.
- Press **REPEAT/SCAN** button to select **“REP 1”** (repeat one) or **“REP ALL”** (repeat all).

Note: These controls do NOT always function in all playback mode.
Repeat function only works in CD and USB mode.

Program Function

This function enables you to set the playback of tracks into an ordered playlist.

1. Press the **STOP/PAIR** button; then press the **PROG/MEMORY** button to activate the program feature. The display will show “PROG”, “P01” and blinking “000”.
2. Press the **⏮/⏪** or **⏩/⏭** button to select your track.
3. Press the **PROG/MEMORY** button again to confirm.
4. Repeat the step 2 and 3 to program other tracks.
5. After finished, press the **⏸/BT OUT/OK** button to start playback.
6. Press the **STOP/PAIR** button once to stop.
7. Press the **STOP/PAIR** button twice to erase the programmed track, and “PROG” will disappear from the display.

Note:

- This feature functions in CD and USB mode.
- This unit can program up to 20 tracks in CD mode and up to 99 tracks in USB mode.
- Turning the power off or switching to other playback modes by turning the Function Knob will automatically erase the programmed playlist.

TURNTABLE BELT SETUP

1. Unpack the unit and remove all packaging materials.

2. Place the belt on the motor pulley. Align one of the platter openings with the motor pulley, and while pulling both ends of the red ribbon that comes attached to the belt, place the belt on the motor pulley, as per the diagram. When doing this, be careful not to twist the belt.

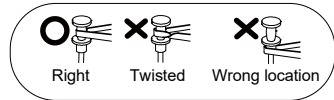
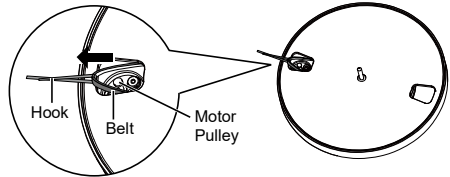

3. Remove the red ribbon from the belt.

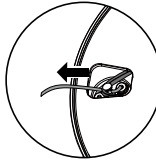

4. Using your hands, slowly rotate the platter 2-3 circles in a clockwise direction. This step is for resetting the auto mechanism, getting rid of any twists in the belt and making sure the belt rides smoothly along the drive rim on the underside of the platter.

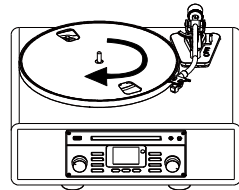

5. Place the slip mat on top of the platter. Make sure the logo on the mat is facing up.

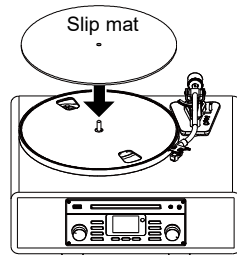

Note:

- The belt is a consumable part. Replace the belt if the speed of playback slows down or irregular rotation occurs. As a rule of thumb, we suggest replacing the belt once a year.
- Before replacing the belt, be sure to unplug the AC adapter from the outlet.

ADJUST THE COUNTERWEIGHT

The supplied Counterweight is suitable for cartridges weighing 2.0 - 4.5g. Each mark of the dial represents 0.1g.

The recommended tracking force for the default cartridge is $3.5 \pm 0.5g$. You can choose one of the following methods to adjust the counterweight.

Note: The counterweight is installed by default and the short line is aligned to "1.5" on the dial.

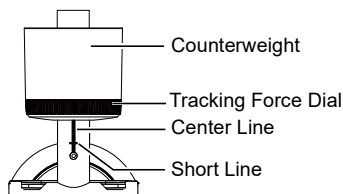

Method 1

Gently rotate the counterweight in the direction of the arrow until the short line is aligned to the number "1.5" on the dial.

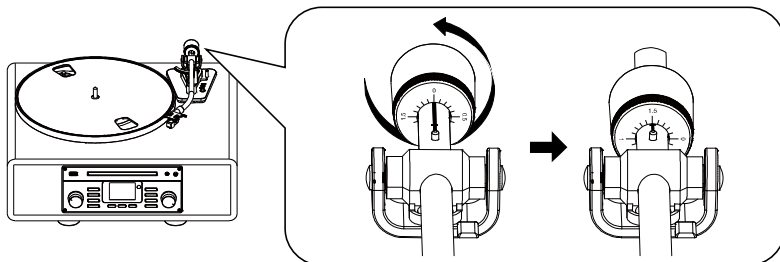

Method 2

1. Slowly move the tone arm away from the tone arm support. Pull out the stylus protector.

Note: Applying a downward force may cause the stylus to come off the cartridge. If the stylus has come off, please reattach the stylus refer to "HOW TO REPLACE THE STYLUS".

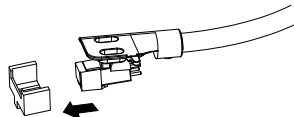

2. Carefully rotate the Counterweight until the tone arm achieves a neutral balance.

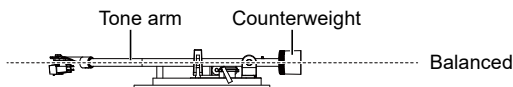

3. When the tone arm is balanced, move the tone arm to the support. Hold the counterweight in one hand and rotate the tracking force dial with the other hand until the "0" is aligned with the center line.

Note: Make sure the tone arm is still neutrally balanced.

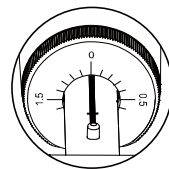

4. Gently rotate the counterweight for 1.75 circles in the direction of the arrow until the center line is aligned with the number "1.5" on the dial.

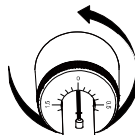

RADIO OPERATION

1. Set the Function Knob to **TUNER** position.

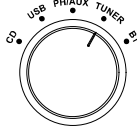

2. Press and hold the **EQ/AM/FM** button to receive AM or FM signals. Note to extend the FM antennae when you want to listen to FM stations.
3. To search for available stations, you can:
 - a. Press and hold the **◀◀/▶▶** or **▶▶/▶▶** button on unit.
 - b. Press the **◀◀** or **▶▶** button on remote control.
 - c. Press **REPEAT/SCAN** button on unit or remote control to search and store the available stations automatically, and it can store 20 stations.
4. Adjust the volume by switching the **VOLUME +/-** Knob.
5. You can store your favorite station to the unit and listen to it conveniently by following steps:
 - a. When you are listening to a radio channel, press **PROG/MEMORY** button on unit or **PROGRAM** button on remote control, "P01" will appear and blink on the display.
 - b. Press **USB/MP3/DISC/FOLDER** buttons to select a number as the serial number of the current channel.
 - c. Press **PROG/MEMORY** button again to confirm.
 - d. Repeat the b-c steps to store other your favorite radio channels.
 - e. To listen to the stored radio channels, just press **USB/MP3/DISC/FOLDER** buttons on unit or **◀◀** and **▶▶** button on remote control to select the serial number of your favorite radio channel, then the selected channel starts to play.

You can improve the signal receiving strength by:

- Extending the FM Antenna to a higher position.
- Turn the unit to face different directions.
- Move the unit to a different place.
- Connect the FM Antenna to your outdoor antenna.

CD OPERATION

1. Set the Function Knob to **CD** position.

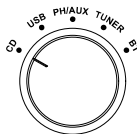

2. Press the **OPEN/CLOSE** button to open the disc tray.
3. Place your desired audio CD on the tray with its label side up.
4. Press the **OPEN/CLOSE** button to close the tray.
5. The CD will start to play automatically.

Note:

- Do not pull or push the disc tray manually.
- Ensure the disc is placed in the center of the disc tray with its label side up.
- Be sure the inserted disc is an Audio CD / MP3 CD, not DVD or any other type of disc.

AUX IN OPERATION

1. Insert one end of the 3.5mm AUX in cable into the AUX IN Jack on the upper right of the front control panel, the other end to your playing device.

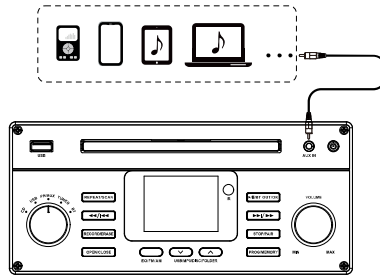

2. Set the Function Knob to **PH/AUX** position.

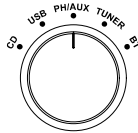

3. Start to play your favourite music on your playing device.

USB OPERATION

1. Set the Function Knob to **USB** position.

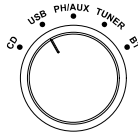

2. Insert a USB device (only with .mp3 audio files) to the USB Port.
3. The unit will start playback automatically.
4. Use the volume and control buttons to control playback.

Note: Control buttons may not work with all USB devices due to manufacturing differences.

Recording with USB

With this function you can record music from your player onto a USB device in .mp3 format.

1. Insert a USB device into the USB port.
2. Play music in the CD, Phono, AUX, BT mode.
3. The operations are different in specific modes:
 - a. When playback in CD mode, press the **RECORD/ERASE** button and then press **◀◀/▶▶** or **▶▶/▶▶** button to select “**SEL ONE**” (record one) or “**SEL ALL**” (record all). Finally press the **RECORD/ERASE** button to confirm and “**REC**” will appear on the display. Recording starts.
 - b. When playback in other modes, press the **RECORD/ERASE** button and “**REC**” will appear on the display which indicating recording starts.
4. Press the **STOP/PAIR** button on unit to stop recording, and “**REC-END**” will appear on display. Now the recording process ends.

Note: If you want to listen to the latest record track, just press **◀◀/▶▶** button when play in USB mode.

Erasing Files on the USB Device

1. Insert a USB device into the USB port and play the song you want to delete.
2. Press and hold the **RECORD/ERASE** button for about two seconds, "DEL ONE" will appear on the display.
3. Press the **◀/▶** or **▶/▶** button to select:
 - a. DEL ONE - erase the current track
 - b. DEL FOLD - erase all the audio tracks in the entire folder
 - c. DEL ALL - erase all the audio tracks of the USB device
4. Press the **RECORD/ERASE** button again to confirm. "DEL WAIT" will appear, and erasing process starts.
5. When all tracks and folders erased, "NO SONG" will be shown on display.

BLUETOOTH® OPERATION

With the Bluetooth® in function, you can play music from an external Bluetooth® device on the speakers of this unit.

1. Set the Function Knob to **BT** position. "Disconnect" will blink on display.

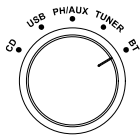

2. Turn on your external Bluetooth® device and pair with the "JC-9021" device.
3. When the Bluetooth® connection is established, you will hear a short confirmation sound from the unit, and "Connected" will appear on display.
4. Start to play your favorite music on the connected device.
5. To disconnect the current Bluetooth® device, press and hold **STOP/PAIR** button on unit or press **PAIR** button on remote control.

Bluetooth® Transmitter

You can play music from this unit on external Bluetooth® speakers, soundbar, earbuds, or headphones.

1. Set the unit to CD/ Phono/ AUX/ USB/ Tuner mode.
2. Press and hold **▶/BT OUT/OK** button to activate Bluetooth® Transmitter function. "BT" will blink on display.
3. Power on your Bluetooth® device and activate its Bluetooth® pairing mode.
4. Press and hold **REPEAT/SCAN** button on the unit or remote control to search for the external device.
5. After a few seconds, the panel will appear the Bluetooth® names of external devices, then press **◀/▶** or **▶/▶** button to select the desired one and press **▶/BT OUT/OK** button to confirm.
6. After a few seconds, the external device will connect to this unit successfully. "BT" will stop blinking.
7. To turn off BT OUT mode, press and hold **▶/BT OUT/OK** button.

VINYL RECORD OPERATION

1. Press the **Power Button** to turn on the unit and open the cover.
2. Set the Function Knob to **PH/AUX** position.

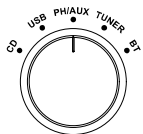

3. Detach the stylus protector by pulling straight in the direction shown.

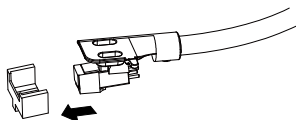

4. Place a vinyl record on the Turntable by aligning the Turntable Spindle to the record hole.
5. Press the Speed Selector to select 33, 45 or 78 to match the play speed of the record.
6. Unlock the Hold Down Clip.

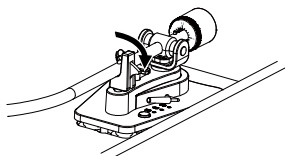

7. Raise the Cue Lever to lift the tone arm off the tone arm support.
8. Gently move the tone arm to the edge of the record (or the starting point of a track).
9. Release the Cue Lever to put the tone arm onto the record. Turntable will begin playback.
10. Turn the VOLUME +/- Knob to adjust the volume. To pause/stop during playback, raise the Cue Lever to lift the tone arm off the record.
11. When finished listening:
 - a. Raise the Cue Lever to lift the tone arm off the record.
 - b. Move the tone arm to its support.
 - c. Lower the Cue Lever to release the tone arm.
 - d. Lock the Hold Down Clip.

Note:

- Make sure there is no AUX IN cable inserted in the unit, or it will be in AUX IN mode.
- Put the 45 RPM Adapter across the Turntable Spindle firstly if playing a 45 RPM record.
- After you play 78 RPM vinyl record, it will stop in about 120 seconds.

CARE & MAINTENANCE

Always keep the turntable clean. If the surface of the unit gets dirty, wipe with a soft dry cloth or use a diluted mild liquid soap. Be sure to remove any excess liquid completely. Do not use thinner, benzene or alcohol as they may damage the surface of the unit. Allow the surface of the unit to dry completely before using.

Beware of condensation

When the unit (or a record/disc) is moved from a cold to warm place, or used after a sudden temperature change, condensation may form; vapor in the air could condense on the internal mechanism, making correct operation erratic or impossible. To prevent this, or if this occurs, leave the unit turned off for one or two hours. The unit will stabilize at the temperature of its surroundings.

Using Compact Discs

Discs which can be played on this unit:

- Conventional audio CD
- Properly finalized CD-R and CD-RW discs
- Always place the disc on the disc tray with the label side up. (Compact discs can be played or recorded only on one side.)
- To remove a disc from its storage case, press down on the center of the case and lift the disc out, holding it carefully by the edges. Should the disc become dirty, wipe the surface radially (from the center hole outward towards the outer edge) with a soft, dry cloth.



How to remove the disc



How to hold the disc



How to clean the disc

- Never use such chemicals as record sprays, antistatic sprays or fluid, benzene or thinner to clean the discs. Such chemicals will do irreparable damage to the disc's plastic surface.
- Discs should be returned to their cases after use to avoid dust and scratches that could cause the laser pickup to "skip."
- Do not expose discs to direct sunlight or high humidity and temperature for extended periods. Long exposure to high temperatures will warp the disc.
- Do not play any disc that is warped, deformed or damaged. Playing such discs may cause irreparable harm to the playing mechanisms.
- CD-R and CD-RW discs are more sensitive to the effects of heat and ultraviolet rays than ordinary CDs. It is important that they are not stored in a location where direct sunlight will fall on them, and away from sources of heat such as radiators or heat-generating electrical devices.
- Printable CD-R and CD-RW discs are not recommended, as the label side might be sticky and damage the unit.
- Do not stick papers or protective sheets on the discs and do not use any protective coating spray.
- Use a soft oil-based felt-tipped pen to write the information on the label side. Never use a ball-point or hard-tipped pen, as this may cause damage to the recorded side.
- Never use a stabilizer. Using commercially available CD stabilizers with this unit will damage the mechanisms and cause them to malfunction.
- Do not use CDs with an irregular shape (octagonal, heart shaped, business card size, etc.). CDs of this sort can damage the unit:

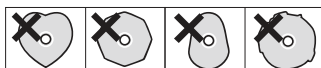

- If you are in any doubt as to the care and handling of a CD-R/CD-RW disc, read the precautions supplied with the disc, or contact the disc manufacturer directly.

CARE & MAINTENANCE

Using Cassette Tapes

Tape Handling:

- Use your finger or a pencil to turn the cassette tape's hub and take up any slack tape.
- Avoid touching the tape. Fingerprints attract dust and dirt.
- Avoid dropping or subjecting cassettes to excessive shocks.
- As C-120 tapes are physically weak and could become entangled in the transport mechanism, do not use them.

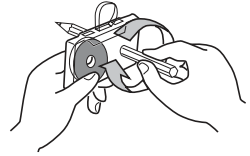

Do not store tapes in the following places:

- On top of heaters, exposed to direct sunlight or in any other places with high temperatures.
- Near speakers, on TV sets or amplifiers or where they would be exposed to strong magnetic fields.
- Where humidity is high or in dirty, dusty places.

Head Maintenance

The head and tape path should be cleaned and demagnetized periodically. Please use a cassette type head cleaning tape and demagnetizer. For specific details on the proper use of either item, please read each item's instruction manual.

Maintaining Vinyl Records

- Do not touch the record's grooves. Only handle records by edges or label.
- Make sure your hands are clean. Skin oils from even clean hands can leave a residue on the record surface that will gradually deteriorate the quality of your record.
- Keep your records away from dust. Store in a cool, dry place.
- Keep records in sleeves and jackets when not in use to avoid dust and scratches.
- Store records upright on edges. Records stored horizontally will bend and warp.
- Do not expose records to direct sunlight or high humidity and temperature. Long exposure to high temperatures will warp records.
- Do not store records in the trunk of a car.
- Store records in an area with a stable temperature and low humidity.
- Should the record become dirty, gently wipe surface in a circular motion, using a soft anti-static cloth.

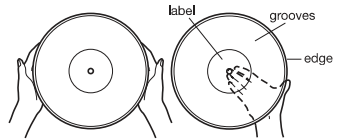

HOW TO REPLACE THE STYLUS

The stylus should last about 200 hours under normal use. However, it is recommended that the stylus be replaced as soon as you notice a change in sound quality. Prolonged use of a worn-out stylus may damage the record. Wear and tear on the stylus will be accelerated when playing 78 RPM records. The higher speed of 78 RPM records can wear the stylus more quickly .

Caution:

- Do not bend the stylus.
- To avoid injury, do not touch the needle.
- Turn off the unit's power before you replace the stylus.
- Keep out of the reach of children.
- Handle with care, as the stylus is delicate. Use of a bent or broken stylus may damage the record and cause the turntable to malfunction.
- Do not expose stylus to extreme heat.
- Contact a qualified repair company if you experience difficulty in changing the stylus.

Remove and install the stylus

1. Pull down the front of the stylus and then pull out in straight direction.

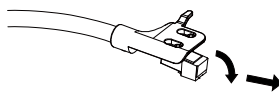

2. Engage the stylus in the cartridge as the follow diagram. Lift the stylus up until you hear a click.

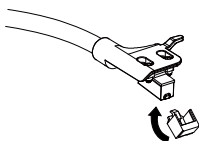

Note: Make sure there is no gap between the stylus and the cartridge.

TROUBLESHOOTING GUIDE

In case of trouble with the unit, please look through the problems below and see if you can solve them yourself before calling your dealer.

Function	Problem	Solution
General	No power	<ul style="list-style-type: none"> Check the connection to the AC power source. Make sure the AC source is not a switched outlet and if it is, turn the switch on. Make sure there is power to the AC outlet by plugging another item such as a lamp or fan.
	No sound	<ul style="list-style-type: none"> Adjust the volume. Connect the AUX IN cables into the correct jack.
	The sound has interference	<ul style="list-style-type: none"> The unit is too close to a TV set or similar appliance. Relocate the unit further away from them or turn the other appliances off.
Radio	Cannot listen to any station or signal is weak	<ul style="list-style-type: none"> Tune in the station properly. If a TV is near the unit, turn it off. Rotate the unit or antenna wire for the best reception position.
Record Player	Will not play	<ul style="list-style-type: none"> Turn the VOLUME KNOB clockwise. Loosen the screw and detach the stylus guard. The stylus guard is a white plastic cover that protects the stylus during transportation. Failing to remove this guard will not allow the needle to contact the grooves of the record and no sound will be heard! If the stylus is worn-out, change the stylus. Select the correct playback speed.
	Sound skips	<ul style="list-style-type: none"> Place the unit on a stable surface to avoid vibration and shock. Make sure the unit is level both front to back and side to side. Clean the surface of the record/disc. Do not use scratched, damaged or warped records/discs.
CD Player	Will not play	<ul style="list-style-type: none"> Turn the VOLUME knob clockwise and rotate the FUNCTION KNOB to "CD". Load a disc with the playback side facing down. If the disc is dirty, clean the surface of the disc. A blank disc has been loaded. Load a pre-recorded disc. Depending on the disc, it may not be possible to play back CD-R/CD-RW discs. Try again with another disc. You cannot play unfinalized CD-R/CD-RW discs. Finalize and try again.
Bluetooth®	Will not play	<ul style="list-style-type: none"> Device is NOT paired properly; turn OFF Bluetooth, turn ON Bluetooth and repair device.

SPECIFICATIONS

Turntable Speed: 33-1/3, 45, 78 RPM

Speaker Output: 10W x 2

Speaker Frequency: 20Hz-20KHz

Compatible CD Formats: CD / CD-R / CD-RW / CD-MP3

AM Frequency Range: 520 - 1710 KHz

FM Frequency Range: 87.5-108 MHz

Bluetooth® Version: 5.3

Input: Aux In, USB

Output: Line Out

Power Source: AC 100-240V~50/60Hz, DC 15V/1.5A

Accessories Included: AC Adaptor, Felt Slipmat,
Remote Control, 45RPM Adapter, Aux In Cable, User Manual

Support@otic.shop

Shenzhen Junlan Electronic Ltd.

Add: No. 71 Lijing South Road, Pingshan District, Shenzhen, CHINA



Made in China

