

RADDY VP7

PROFESSIONAL WEATHER STATION User Manual



Thank you for your purchase.

Please read this operation guide carefully and keep it properly before use.

Contents

Features ----- 2

Weather Station Appearance ----- 3

Multi-combination Wireless Remote Sensor Appearance ----- 5

Temperature | Humidity Wireless Remote Sensor Appearance (Optional sensor) ----- 6

Setup Preparation ----- 7

Quick Setup ----- 7

Time and unit settings ----- 7

Radio control clock (Abbreviation: RCC) timing ----- 8

Alarm function control ----- 9

Alarm and Snooze settings ----- 9

Temperature | Humidity Readings | History | Trend ----- 10

Wind Readings | History ----- 10

Rain Readings | History ----- 11

Wireless sensor connection ----- 11

Weather alerts viewing and setting ----- 12

Weather alert trigger ----- 13

Weather forecast ----- 13

Background lighting ----- 14

Mounting Instructions (wireless sensor) ----- 15

Specification ----- 16



Features

- WWVB Radio control time function
- Perpetual Calendar Up to Year 2099
- Day of week in 7 languages user selectable: English, German, Italian, French, Spanish, Netherlands and Danish
- Two daily alarms
- Automatic snooze function (OFF or 5~60min)
- Temperature:
 - Indoor temperature measurement ranges: 0°C (32°F) to 50°C (122°F)
 - Outdoor temperature measurement ranges: -40°C (-40°F) to 70°C (158°F)
- Humidity:
 - Indoor and outdoor humidity measurement ranges: 20% to 95%
- Air pressure:
 - Air pressure range: 600 to 1100 hPa (17.72 to 32.48 inHg or 450 to 825.1 mmHg)
- Rain
 - Rain range: 0 to 9999mm (0-393.6 inches)
- Wind
 - Wind speed range: 0 to 180 km/h (0 to 111 mph)
 - Wind direction range: 0 to 359 degrees
- Wireless Outdoor Sensor.
 - 433.92MHz RF transmitting frequency
 - 100 meters (300 feet) transmission range in an open area, not including walls or floors
- Record of temperature, humidity, wind speed and rainfall
- Alert of temperature, humidity, wind speed, rainfall
- Display of feels like temperature, wind chill temperature, heat index, dew point temperature
- The weather forecasting function
- Level 3 display backlight
- USB charging function
- Power Supply:
 - Weather station:
 - Power Adapter: DC5V 1.2A
 - Battery: 2 x LR3 AAA 1.5V
 - Multi-combination Wireless Remote Sensor:
 - Battery: 3 x LR6 AA 1.5V
 - Temperature | Humidity Wireless Remote Sensor
 - Battery: 2 x LR6 AA 1.5V

F.Y.I.:

The wireless remote sensor can work at -30°C to +70°C. Please choose the right battery according to the limit temperature of the wireless sensor:

Alkaline zinc manganese battery can work at -20°C to +60°C

Polymer lithium ion rechargeable battery can work at -40°C to +70°C



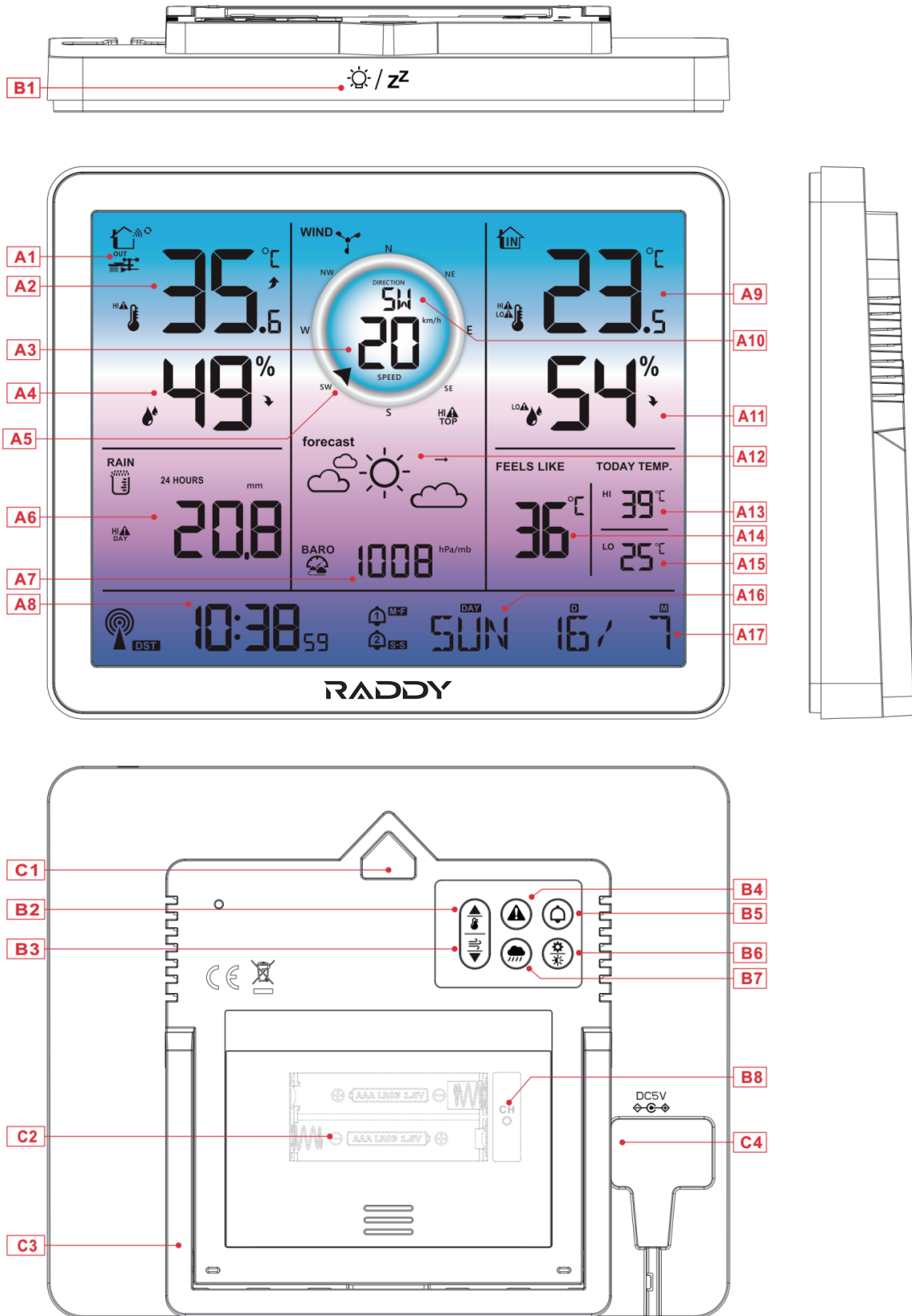





Weather Station Appearance











Part A - Positive LCD

- A1: Outdoor wireless channel: OUT | CH1 | CH2 | CH3
- A3: Value of wind speed
- A5: Wind direction steering wheel
- A7: Air pressure
- A9: Indoor temperature
- A11: Indoor humidity
- A13: Today's highest temperature record
- A15: Today's lowest temperature record
- A17: Calendar

- A2: Outdoor temperature
- A4: Outdoor humidity
- A6: Rainfall
- A8: Time
- A10: Wind direction or wind top speed of 1Hr
- A12: Weather forecast
- A14: Feels like temperature
- A16: Day of the week

-  RCC Signal Icon
-  DST Summer time icon
-  Alarm 1 icon
-  Alamm 2 icon
-  M-F Monday-Friday repeat alarm icon
-  S-S Saturday-Sunday repeat alarm icon
-  Alarm snooze icon
-  Wireless receiving icon
-  Wireless channel loop icon

-  Battery low pressure icon
-  HI High temperature alert icon
-  LO Low temperature alert icon
-  HI DAY 24-hour rainfall alert icon
-  HI RATE Rainfall intensity alert icon
-  HI TOP Top wind speed alert icon
-  Wind icon
-  Temperature | humidity up trend arrow
-  Temperature | humidity down trend arrow

Part B - Buttons

- B1: "  /  " touch location
- B2: "  " button
- B3: "  " button
- B4: "  " button
- B5: "  " button
- B6: "  " button
- B7: "  " button
- B8: " CH " button

Part C - Exterior

- C1: Hanging hole
- C2: Battery compartment
- C3: Support frame
- C4: Power supply socket



Multi-combination Wireless Remote Sensor Appearance

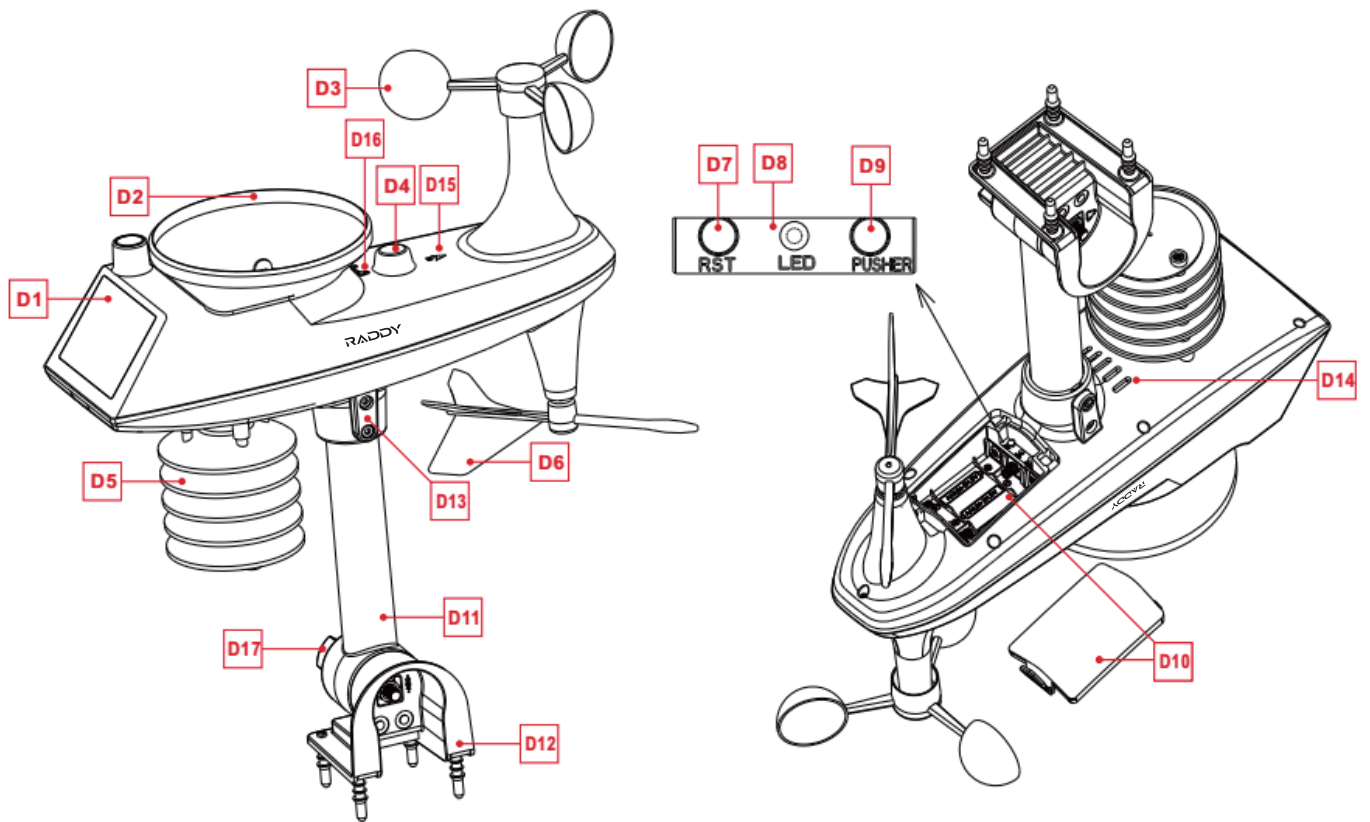

Part D - Exterior

- D1: Solar panel
- D2: Rain funnel
- D3: Wind cups
- D4: Bubble level
- D5: Temperature | humidity induction box
- D6: Wind Directional Vane
- D7: Reset button
- D8: LED indicator
- D9: Manual transmit signal button
- D10: Battery compartment
- D11: Support rod
- D12: Fixed base
- D13: Socket head cap screws
- D14: Drain vents For rain sensor
- D15: North direction mark
- D16: Rain funnel rotation mark
- D17: Large nut for fixing the support rod and the base



Temperature | Humidity Wireless Remote Sensor Appearance (Optional sensor)

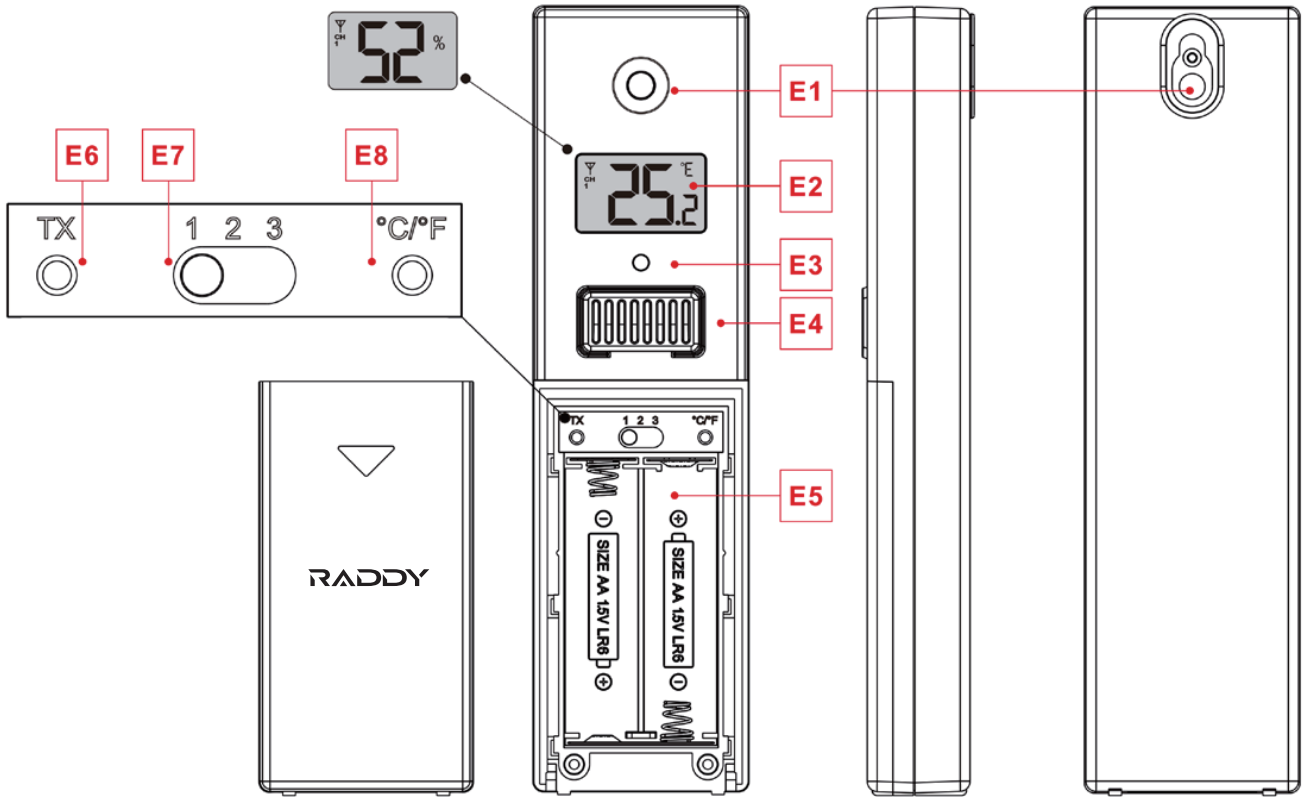

Part E - Exterior

- E1: Hanging hole
- E2: LCD display
- E3: LED indicator
- E4: Temperature | Humidity sensing louver
- E5: Battery compartment
- E6: Manual transmit signal button "TX"
- E7: "CHANNEL 1 or 2 or 3" switch
- E8: Reset button



Setup Preparation

Items you will need to setup your station (not included):

1. Crosshead screwdriver and hex driver for assembly.
2. Fresh Batteries:
 - 2 (two) AAA alkaline or lithium batteries for the weather station.
 - 3 (three) AA alkaline or lithium batteries for the multi-combination sensor.
 - 2 (two) AA alkaline or lithium batteries for the temperature | humidity sensor (Optional)

For best results:

- Remove weather station and sensors from the package and place together on a table or bench, within easy reach.
- Place batteries and screwdriver within reach of setup location.
- Keep sensors and weather station 0.15-0.3 meter or 5-10 feet for at least 15 minutes after installing batteries, to allow the sensors and station to connect repeatedly.

Quick Setup

1. Insert 3 AA batteries into the multi-combination wireless remote sensor
2. 3-AA battery entry temperature humidity wireless remote sensor
3. Then plug the power cord into the weather station
4. Configure basic settings. Set time, date, unit, etc.
5. Insert 2 AAA batteries into the weather station (when the power adapter is unexpectedly powered off, the settings will not be lost)
6. Move the remote sensor to outdoor or other location after 5 minutes
7. Move the weather station to the appropriate location, with a minimum distance of 2.5 meters from all sources of interference, such as a television or computer monitor, radio reception is weaker in rooms with concrete walls (e.g..in cellars) and in offices. In such extreme circumstances, place the weather station close to the window.

Note: The weather station has a radio control clock calibration time function. After power-on, after searching the wireless sensor for 3 minutes or all channels successfully search for the wireless sensor, the weather station will automatically enter the radio control clock timing mode. If you need to set the time and unit manually, you need to press and hold the "▲" button to exit the radio time mode, and then continue to the next step.

Time and unit settings

- Press and hold the "⏸" button for 3 seconds to enter the time setting mode.
Press and release the "▲" or "▼" button to adjust the value. Hold the "▲" or "▼" button to adjust quickly.
Press and release the "⏸" button to confirm and move to the next item.

Note: After 20 seconds without pressing any button or touch the "🌞/z" location button at any time to exit the settings.

Settings order:

1. BEEP ON/OFF
2. Temperature unit: °C | °F
3. Pressure unit: hPa | inHg | mmHg
4. Wind speed unit: KM/H | MPH
5. Wind degree (angle) or direction (letter) selection
6. Rainfall unit: MM | inch
7. Radio control clock function: ON | OFF
8. Time zone: -1 to 2 hr
9. Hour format: 24Hr | 12Hr
10. Hour
11. minutes
12. Calendar display format Month/Date | Date/Month
13. Year
14. Month
15. Date
16. Week display language: a total of seven countries
17. Initialize weather settings

Note: When the weather station is in the same area as Germany, the time zone is set to 00, one hour slower than German time, the time zone is set to -01, one hour faster than German time, the time zone is set to 01, 2 hours faster than German time, time zone Set to 02

Note: Exceeding the German signal tower diameter of 1500KM or more, the signal received by the radio clock signal is very poor. It is recommended to set the RCC to OFF

Note: In the set time, the number of minutes of the change, automatically from the zero second forward

Note: There are 8 languages of Weekday. English, Deutsch, Francais, Italian, Espafiol, Nederlands and Dansk.

Week language display

Language	Sunday	Monday	Tuesday	Wednesday	Thursday	Friday	Saturday
English, ENG	SUN	MON	TUE	WED	THU	FRI	SAT
German, GER	SON	MON	DIE	MIT	DON	FRE	SAM
French, FRE	DIM	LUN	MAR	MER	JEU	VEN	SAM
Spanish, SPA	DOM	LUN	MAR	MIE	JUE	VIE	SAB
Italian, ITA	DOM	LUN	MAR	MER	Glo	VEN	SAB
Dutch, DUT	ZON	MAA	DIN	WOE	DON	VRI	ZAT
Danish, DAN	SON	MAN	TIR	ONS	TOR	FRE	LOR

Radio control clock (Abbreviation: RCC) timing

- After the weather station searches for the wireless sensor after power-on, (up to 3 minutes) will automatically enter the RCC timing mode. The weather station will automatically search for the RCC signal for 7 minutes, the RCC signal icon will flash and the backlight will automatically turn off.

Note: Enter the RCC signal search mode. Since the RCC signal search requires the device to be in a static working state as much as possible, the backlight is automatically turned off to prevent signal interference. Please try not to control the weather station within seven minutes. If you need to exit the search mode of the RCC signal, press and hold the "▲" button for 3 seconds to exit.



- The weather station will automatically perform an RCC signal search at 1:00 / 2:00 / 3:00 every day to correct any deviation from the precise time. If this sync attempt is unsuccessful (the radio mast icon disappears from the display) the system will automatically try another sync for the next full hour. This process is automatically repeated up to 5 times a day.
- If you need to manually search for RCC signals, press and hold the "📶" button for 3 seconds to enter the search mode. Again, the longest search is 7 minutes.
Note: The flashing radio mast icon indicates that the RCC signal search is in progress. Continuous display of the continuously displayed radio mast icon indicates that the successful RCC signal finding is completed and the calibration time is successful. The icon "DST" indicates that the calibration time is the daylight saving time.

Alarm function control

- Press and release the "🔔" button to view the alarm 1 time, press and release the button to view the alarm 2 time, the third release and release the button to exit the viewing mode.
- In the mode of viewing the alarm 1 time or the alarm 2 time, press and release the "🔔" button to control its alarm function to be turned on or off.
Note: When the function of Alarm 1 or Alarm 2 is turned on, the symbol "🔔1" or "🔔2" is displayed. At the same time, the relevant alarm repeat symbol "M-F" | "S-S" is displayed
Note: After 20 seconds without pressing any button or touch the "🌞/z" location button at any time to exit the view mode.

Alarm and Snooze settings

- Press and hold the "🔔" button for 3 seconds to enter the alarm and snooze setting mode.
- Press and release the "⬆️" or "⬇️" button to adjust the value. Hold the "⬆️" or "⬇️" button to adjust quickly.
- Press and release the "🔔" button to confirm and move to the next item.
Note: After 20 seconds without pressing any button or touch the "🌞/z" location button at any time to exit the settings.

Settings order:

1. Alarm 1 hour
2. Alarm 1 minutes
3. Alarm 1 repeat: M-FISS IMS
4. Alarm 1 snooze time: 5 to 60minutes | OFF
5. Alarm 2 hour
6. Alarm 2 minutes
7. Alarm 2 repeat: M-F | S-S | M-S
8. Alarm 2 snooze time: 5 to 60minutes | OFF

- Note:** The alarm is repeatedly set to M-F, the alarm function will be activated from Monday to Friday, the Saturday and Sunday will be invalid. The alarm is repeatedly set to S-S, and the alarm function will be activated on Saturday and Sunday, and will expire from Monday to Friday. When the alarm is repeatedly set to display both M-F and S-S, the alarm function will be activated throughout the week.

- Note:** The snooze time setting range: 5~60MIN, OFF, when set to OFF, means no snooze function. Snooze time unit is minutes.
- Note:** The alarm will sound for 1 minutes if you do not deactivate it by pressing any button. In this case the alarm will be repeated automatically after 24 hours.
- Note:** Rising alarm sound (crescendo, duration: 2 minutes) changes the volume 4 times whilst the alarm signal is heard.

Switching off the alarm signal

- The alarm sound when the trigger, press any buttons except the "☀/zZ" touch button or touch and hold the "☀/zZ" button for more than 3 seconds to stop the alarm signal.

Snooze function

- When the time is up to the alarm, touch and release the "☀/zZ" touch button, the alarm signal stops, and enter the snooze timing mode. At the end of the snooze timer, it will ring again (can repeat snooze)
- In snooze timing mode, press any buttons except the "☀/zZ" touch button or touch hold down the "☀/zZ" touch button for more than 3 seconds to exit the snooze mode

Temperature | Humidity Readings | History | Trend

- Press and release the "▲" button to view High | Low temperature and humidity and feels like temperature, dew point temperature, heat index, wind chill index.
- In the view High | Low temperature or humidity mode. press and release the "CH" button to switch to view the records of other channels.
Note: feels like temperature, dew point temperature, heat index and wind chill index is related to the value detected by the multi-combined wireless remote sensor.
- In the mode of viewing temperature | Humidity history, press and hold the "🗑" button for 3 seconds to clear all history of indoor | outdoor remote temperature Humidity.
Note: Indoor | outdoor remote temperature | Humidity reading will reset to current value.
Note: After 20 seconds without pressing any button or touch the "☀/zZ" location button at any time to exit the view mode.
- Indoor | outdoor remote temperature | humidity will have trend change tips
 ↗ : Temperature / humidity is rising.
 ↘ : Temperature/humidity drops.
 No display: temperature/humidity remains unchanged.

Wind Readings | History

- In the main display interface, press and hold the "🌀" button for 3 seconds to convert the display to wind direction or display as 1 hour top speed
Note: WIND SPEED: average speed over the past 30 seconds
 1HR TOP SPEED: Highest speed in the past hour
 WIND DIRECTION: In letters or degrees

Note: The conversion is displayed as a wind direction display or 1 hour top speed can only be operated under the main display interface.

- View history. Press and release the "  " button to view the maximum wind history values: 1 Hour (default) | 24 Hour | 7 Days | Month | Year

Note: One Hour: past 60 minute period (default Top Speed record, already shown)

24 hour: Past 24 hour period, from last record

7 Days: Past 7-day period, from last record

Month: Defined by Calendar Month i.e. January 1 - January 31

Year: Defined by Calendar Year i.e. January 1 - December 31

- In the mode of viewing wind speed history, press and hold the "  " button for 3 seconds to clear all history of wind speed.

Note: Wind speed reading will reset to current wind speed.

Note: After 20 seconds without pressing any button or touch the "  / zZ " location button at any time to exit the view mode.

Rain Readings | History

- In the main display interface, press and hold the "  " button for 3 seconds to convert the display to cumulative value of rainfall or rate of rainfall

Note: Rainfall: from current to past (1 hour | 24 hours | day | 7 days | month | year | total) total accumulated rainfall

Rainfall rate: average rainfall over the past 12 hours per hour

Press and release the "  " button to view the rain history

Note: NOW: cumulative value over the past 30 minutes

HOUR: cumulative value over the past 60 minutes

24 HOURS: The cumulative value of the past 24 hours

DAY: 24 hr period from 0:00 - 23:59 (12:00am - 11:59pm). Cumulative value with today

7 DAYS: In the past 7 days, the cumulative value of the last record begins

MONTH: The cumulative value defined by the calendar month (ie January 1st - January 31st).

YEAR: The cumulative value is determined by the calendar year, from January 1 to December 31.

TOTAL: The cumulative value of the total run time (no time stamp) since the weather station was started

- In the mode of viewing rain history, press and hold the "  " button for 3 seconds to clear all history of rain.

Note: The rain reading will reset to 0 mm (in).

Note: After 20 seconds without pressing any button or touch the "  / zZ " location button at any time to exit the view mode, The weather station will resume normal time display and display the last rainfall record you viewed. When the rain shows the rain rate before entering the observation mode. it still shows the rain rate when returning from the observation mode to the normal time display.

Wireless sensor connection

- The weather station can connect up to 1 Multi-combination wireless sensor and 3 different channels of temperature | humidity wireless sensor.

- The weather station automatically searches for all wireless sensors within 3 minutes of power-on and registers the sensor IDs. Each sensor generates a random ID after power-on to distinguish the sensors.
- In the main display interface, press and release the "CH" button to view the value of the wireless sensor on the different channels.
Note: In view mode, the ID of the wireless sensor can be displayed.
- The temperature/humidity data of the additional channel wireless sensor needs to be displayed on the normal time display interface. After selecting the channel in the viewing mode. touch the "☀️/z" location button to exit the viewing mode.
Note: The temperature and humidity values shown in the OUTDOOR REMOTE column after exit are the select edchannels. At the same time, in the channel icon (displaying the position of A15), the number of channels isdisplayed: OUTDOOR (representing Multi-combination wireless sensor) | 1 or 2 or 3 (representing 3channels of temperature | humidity wireless sensor)
Note: When the weather station loses sensor signals or the sensor is not connected to the channel, the value of the channel is displayed as "--"
- If you need to add a new sensor or replace the sensor. In channel view mode. press and hold the "🔌" button for more than 3 seconds, the weather station will search for the 3 minute signal again, and the new channel sensor will be added to the weather station within 3 minutes.
Note: When adding a new sensor or replacing a sensor (old sensor replacement battery), you need to turn on the sensor power first, then follow the steps above to control the weather station.
Note: When the channel icon (the position of the display A15) displays the low voltage icon "🔋", the battery of the corresponding channel wireless sensor is replaced according to the channel number of the channel icon. Then follow the steps above to re-add the wireless sensor to the weather station.
- In the normal time display interface, press and hold the "CH" button for 3 seconds. the wireless channel in the OUTDOOR REMOTE column will enter the loop mode, and the channel will be changed every 5 seconds (OUTDOOR | CH1 | CH2 | CH3), and the automatic conversion display will be diferent. Channel temperature | humidity value
Note: In the cycle mode, only the values of temperature and humidity are being converted, and the values of wind speed, wind direction, rainfal, etc. are not converted, and the values are still derived from the Multi-combination wireless sensor.

Weather alerts viewing and setting

- Press and release the "⚠️" button to view the weather alerts mode. Continue to press and release the "⚠️" button to confirm and move to the next item.
Note: After 20 seconds without pressing any button or touch the "☀️/z" location button at any time to exit the view mode.
Note: View Outdoor | REMOTE Temperature | Humidity alert, press and release the "CH" button to switch to other channels. (A total of 4 channels: outdoor | CH1 | CH2 | CH3)
- In each weather alert view item, press and hold the "🔌" button to turn the alert on or off.
Note: The weather alert is initially turned off by default, and the display is OFF. When the weather alert is turned on, it is displayed as ON.
- Press and hold the "⚠️" button for 3 seconds to enter the weather alert setting mode.
- Press and release the "⬆️" or "⬇️" button to adjust the value. Hold the "⬆️" or "⬇️" button to adjust quickly.
- Press and release the "⚠️" button to confirm and move to the next item.
Note: After 20 seconds without pressing any button or touch the "☀️/z" location button at any time to exit the settings.
Note: Set Outdoor | REMOTE Temperature | Humidity alert, press and release the "CH" button to switch to other channels. (A total of 4 channels: outdoor | CH1 | CH2 | CH3)

View and Settings order:

1. Outdoor | remote high temperature
2. Outdoor | remote low temperature
3. Outdoor | remote high humidity
4. Outdoor | remote low humidity
5. Indoor | remote high temperature
6. Indoor | remote low temperature
7. Indoor | remote high humidity
8. Indoor | remote low humidity
9. High wind speed
10. High 24-hours rainfall
11. High rainfall rate



Weather alert trigger



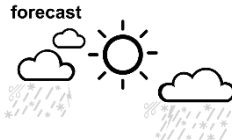
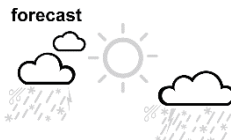

- When armed alert value is reached, station will beep 5 times each minute, until Out of alert range.
- The flashing alert icon will indicate if is a LOW or High alert.
- Press any button to stop the alert sound.
- The alert icon will flash while value is in alert range.

Note: If you want to permanently cancel the alert, enter the weather view mode, switch to the item you want to cancel, press and release the "🔔" button to set to OFF

Weather forecast

- The weather station calculates a weather forecast for about the next 12 hours based on the barometric pressure trend. Of course this forecast can't compare to that of professional weather services supported by satellites and high performance computers, it provides only an approximate indication of the current weather development in a small local area. Please take the weather forecast from your local weather forecasting service into account as well as the forecast from your weather station. If there are discrepancies between the information from your device and from the local weather forecasting service, please take the advice of the latter as authoritative.
- The weather station displays the following weather icon:

Sunny	Mostly cloudy	Cloudy	Rainy	Thunder Rainy
forecast 	forecast 	forecast 	forecast 	forecast 



Snow	Gale		Storm	Snowstorm
forecast 	forecast 	forecast 	forecast 	forecast 

Note: The Snowy icon will only appear if the outdoor temperature (refers to the temperature detected by multiple combined sensors) is below -4°C (+25°F) and the forecast would be rainy or Thunder Rainy.

The Gale icon will only appear if the wind speed is above 50KM/H and the forecast would be Sunny or Mostly Cloudy or Cloudy.

The storm icon will only appear if the wind speed is above 50KM/H and the forecast would be rainy or thunder rain.

The Snowstorm icon will only appear if the outdoor temperature (refers to the temperature detected by multiple combined sensors) is below -4°C (+25°F) and the wind speed is above 50KM/H and the forecast would be rainy or Thunder Rainy.

- After the weather station needs 7-10 days of air pressure calibration, the weather forecast will tend to be stable with an accuracy rate of 70%-75%.
- The weather station can display the barometric pressure trend.
- You may see the following displays.
 -  : The barometric pressure will rise
 -  : The barometric pressure will remain constant.
 -  : The barometric pressure will fall.

Background lighting

- If the product is powered by batteries, Touch the "☀/z" location button. Backlight lit 15 seconds.
- When the power supply of the product is inserted into the power supply adapter, the battery will automatically disconnect the power supply. and the backlight will always be bright. Press the "☀" button to adjust the brightness of the backlight, you can adjust the 4 state: 3 different brightness backlight and close the backlight. When the backlight brightness is not at the maximum brightness. press the "☀/z" button. Backlight turns to maximum brightness of 10 seconds.

Note: During the reception of the time radio wave signal, the backlight will be automatically closed to prevent the interference of the radio wave.

Low battery:

- If the "indoor sensor" column is display the battery icon "🔋", you need to replace the weather station's battery as soon as possible.



Mounting Instructions (wireless sensor)

Multi-combination Wireless Remote Sensor

- Mount in an open area clear for 15 meters (50 feet) in all directions.
- The sensor needs to be mounted on a sturdy platform or bracket that is mounted 1.5 m (5 ft) above the ground.
- The base of the sensor is screwed to the platform and the support frame. Tighten the large nut that secures the support rod to the base.
- When installing, adjust the sensor body so that the solar panel faces south, otherwise the wind direction will be wrong. Note the “N” North Embossed Mark on the top of the sensor (requires a compass for proofreading, and the “N” North Emboss mark is identical to the “N” of the compass).
- When installing the sensor, use the top bubble level to ensure the sensor level, otherwise the accuracy of the rainfall reading will be affected.
- After completing the above two steps, lock the two hexagon socket screws on the side of the sensor body.
- When installing, the fixing screws of the wind cup and the wind direction cursor should be tightened and tightened.
- The rainforest structure of the sensor needs to be cleaned regularly (recommended cycle 1-3 months, depending on the frequency of rain):
 1. Remove the rainwater funnel (turn the rain sand funnel according to the direction of rotation shown).
 2. Gently remove debris or insects from the rainsensor.
 3. Remove debris from the rainwater funne itself, especially debris from the funnel drain.
 4. Remove the debris from the drain.
 5. Reinstall the rainwater bucket.
 6. Note: Do not apply oil to the rain sensor.

Note: Make sure the wireless sensor is installed within 100 meters of the weather station (empty, unobstructed). According to the thickness of the obstacle between the wireless sensor and the weather station, the distance should be shortened as much as possible (the distance after the wireless signal penetrates the obstacle will be shortened), otherwise the data transmission may be disturbed.

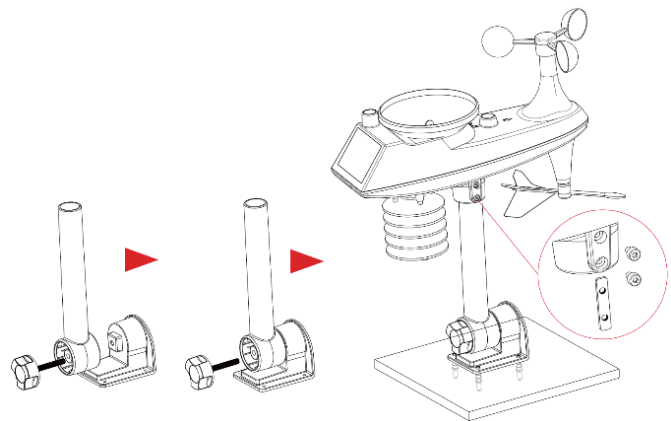

Installation method 1

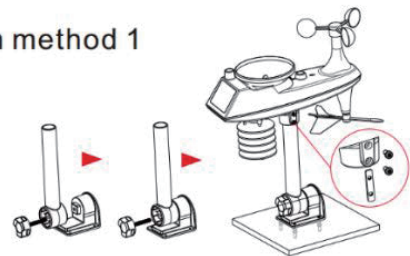

Installation method 2

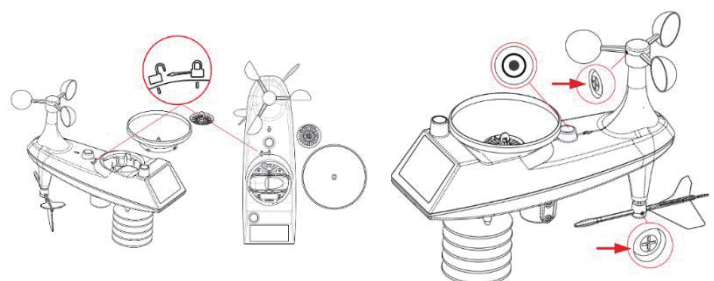
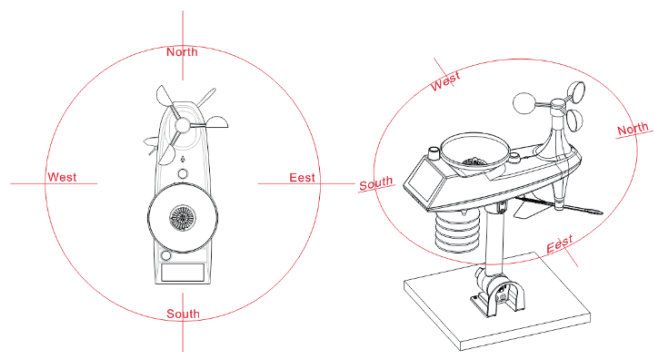
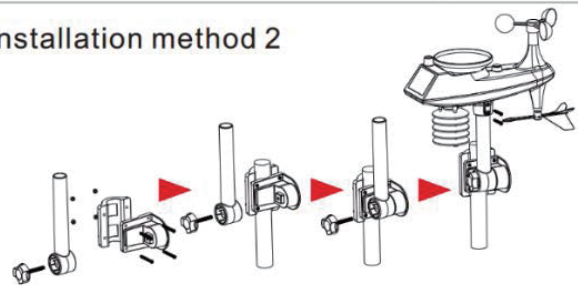

Temperature | Humidity Wireless Remote Sensor (Optional sensor)

Option 1:

- Mount the mounting screws to the wall.
- Hang the wireless sensor on the screw

Option 2:

- Insert the mounting screws through the front of the wireless sensor into the wall.
- Tighten the screws to fit snugly (do not overtighten).
- If the wireless sensor is placed outdoors, install the temperature | humidity wireless sensor on a north facing wall or any shadow. The sun will make it even higher.
- The quadrail under the eaves or under the deck is preferred.
- Make sure the wireless sensor is installed vertically to vent moisture.

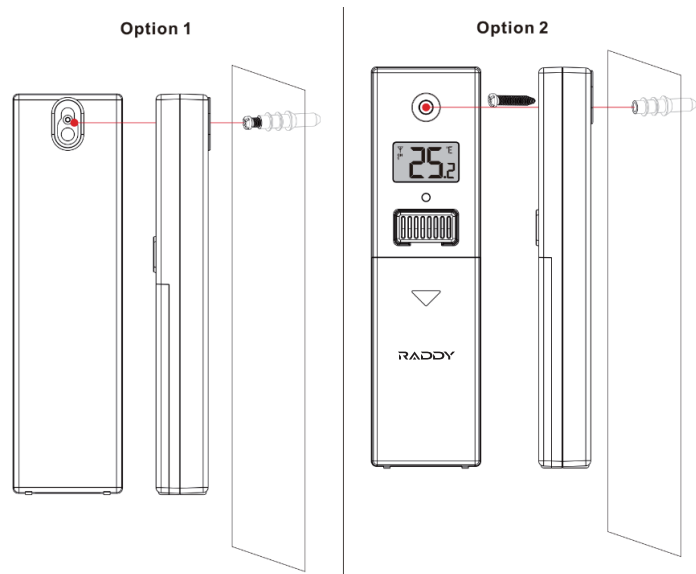

Specification

- INDOOR's temperature detection range: -20°C ~ +60°C & -4°F ~ +140°F, display resolution: 0.1°C & °F
- The detection temperature of INDOOR is lower than -20°C & -4°F, displayed as LL.°C & °F, higher than +60°C & +140°F, displayed as HH.H°C & °F.
- INDOOR humidity display range: 20% RH~95% RH, display resolution: 1% RH
- If the detected humidity of INDOOR is lower than 20% RH, it will be displayed at 19% RH, and if it is higher than 95% RH, it will also be displayed at 96% RH.
- The temperature and humidity detection cycle of INDOOR is 60 seconds
- Temperature display range of OUTDOOR: -40°C ~ +70°C & -40°F ~ +158°F, display resolution: 0.1°C & °F
- The detection temperature of OUTDOOR is lower than -40°C & -40°F, displayed as LL.L°C & °F, higher than +70°C & +158°F, displayed as HH.H°C & °F
- Humidity display range of OUTDOOR: 1% RH ~ 99% RH, display resolution: 1% RH ----- Humidity display range 20 ~ 95%
- When the detected humidity of OUTDOOR is lower than 1% RH, it will be displayed at 1% RH, and if it is higher than 99% RH, it will also be displayed at 100% RH.
- The update period of OUTDOOR's temperature and humidity is the same as the synchronization period of RF (see 5.3 for details).
- Wind speed detection range: 0 KM/H ~ 180 KM/H & 0 MPH ~ 111 MPH, display resolution: 0.1KM/H & MPH (display value 0 ~ 99.9) 1 KM/H & MPH (display value above 100)
- When the detected value of wind speed is higher than 180 KM/H or 112 MPH, it will be displayed as HH KM/H or HH MPH.
- Detection range of rainfall: 0 MM ~ 9999 MM & 0 IN ~ 393.7 IN, display resolution: 0.254 MM or 0.01 IN.
- Rain intensity detection range: 0 MM/H ~ 999.9 MM/HR & 0 IN/HR ~ 39.37 IN/HR, display resolution: 0.254 MM/H or 0.01 IN/H
- Air pressure detection range: 600 hPa/mb ~ 1100 hPa/mb & 17.72 inHg ~ 32.50 inHg & 450 mmHg ~ 825 mmHg, display resolution: 1 hPa/mb & 0.01 inHg & 0.1 mmHg

RADDY

 support@iraddy.com

 www.iraddy.com



Made in China