

Whirlpool

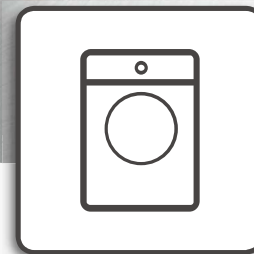

**Health & Safety, Use & Care, Installation Guide and  
Online Warranty Registration Information**

Model: HWEC8002IG  
HWEC8002IW

# CONTENTS



THANK YOU FOR BUYING A WHIRLPOOL PRODUCT.



Read operator's manual

## SAFETY NOTICE AND PRODUCT INTRODUCTION

SAFETY NOTICE.....	2-4
INSTALLATION INSTRUCTIONS.....	4-5
SPECIFICATION SHEET.....	6
NAME OF PARTS.....	7
ACCESSORIES.....	7

## OPERATION INTRODUCTION

DOOR.....	7
INTRODUCTION TO CONTROL PANEL.....	8-9
PROGRAMME CHART.....	9-10
FIRST-TIME AND DAILY USES.....	10
OTHER FUNCTIONS.....	10
HINTS AND TIPS.....	11
INDICATORS.....	12

## CLEANING, MAINTENANCE AND TROUBLESHOOTING

CLEANING AND MAINTENANCE.....	12-14
NO-FAILURE CONDITION.....	14
TROUBLESHOOTING GUIDE.....	15
AFTER-SALES SERVICE.....	16

# SAFETY NOTICE (be sure to observe)

- Please read carefully before use (Precautions) and use it correctly. Any malfunction or loss caused by failure to comply with the precautions stipulated in this installation and usage manual is not covered by the warranty of our company, and our company will not bear any related responsibility.
- The product should not be used by individuals with physical, sensory or mental disabilities or those lacking experience and knowledge in its use (including children), unless they are supervised or guided by a person responsible for their safety in connection with the use of the product.
- Children should be taken good care of to ensure that they do not play with this product.
- In order to prevent harm to users and others or damage to property, the following explanations are made regarding the matters that must be adhered to in terms of safety:
- This appliance is intended to be used in household and similar applications such as staff kitchen areas in shops, offices and other working environments, farm houses, by clients in hotels, motels, and other residential type environments.

### Beware of electric shock

- Except for professionals, no one is allowed to disassemble, repair or modify this machine.
- The specifications and safety details of household power supply systems (current, voltage, cables) such as fuses refer to the "Product Nameplate" standards.
- Please make sure that the power socket that matches the power plug has a grounding connection and the grounding is reliable.
- If the power cord is damaged, to avoid danger, it must be replaced by the manufacturer, its service agency or similar professionals.
- Please hold the power plug with your hand. Do not drag the power cord to unplug it.
- Do not use the power cord when the power plug is loosely connected to the power cord.
- Do not touch the power plug with wet hands. Please wipe off the dust and water droplets on the power plug with a dry cloth. Never touch the power plug with wet hands.
- Do not bend the power cord excessively or place it under heavy objects.
- Do not use if the power cord/socket/power plug is damaged or broken.

### Beware of explosion or fire

- Do not put flammable liquids or gases such as gasoline, petroleum or alcohol into or near the machine. Do not put clothes containing flammable liquids into the machine.
- When there is a leakage of gas or other flammable gas, do not connect or disconnect the power plug.
- Be cautious of fire, short circuit or leakage accidents.
- Do not install this machine near fire sources or heat sources.
- Please do not place any burning candles or cigarettes on this machine.
- Do not install this machine in a place prone to dampness or rain, as water on the electrical components can damage the machine and cause accidents.
- Do not install this machine in direct sunlight to prevent the plastic and rubber parts from aging.
- Do not use the water spray device when cleaning the machine.

### ISO7010 W021: Risk of fire/flammable materials

The Symbol mean: caution, risk of fire Oil-affected items can ignite spontaneously, especially when exposed to heat sources such as in a tumble dryer. The items become warm, causing an oxidation reaction in the oil. Oxidation creates heat. If the heat cannot escape, the items can become hot enough to catch fire. Piling, stacking or storing oilaffected items can prevent heat from escaping and so create a fire hazard. If it is unavoidable that fabrics that contain vegetable or cooking oil or have been contaminated by hair care products be placed in a tumble dryer they should first be washed in hot water with extra detergent - this will reduce, but not eliminate, the hazard.

## SAFETY NOTICE(be sure to observe)

- To avoid fire caused by excessive drying, do not use this machine to dry the following items: MATS, quilts, etc. (These items will accumulate heat).
- When using detergent on clothes, make sure to give them an extra rinse before putting them in the dryer.
- Make sure all pockets are empty and then put the clothes into the dryer.
- Items that have been soiled by substances such as cooking oil, acetone, alcohol, gasoline, kerosene, stain remover, turpentine, wax and wax remover should be washed with hot water and an additional amount of detergent before being dried in the dryer.
- If chemicals are used to clean clothes, the drum dryer cannot be used.
- Cotton shavings are not allowed to accumulate around the drum dryer. Make sure the opening at the bottom is not blocked by the carpet.
- The hot air discharged from the dryer cannot be shared with the exhaust channels of other equipment that burn gases or other fuels.

### Warning

- Do not use this product in a damp environment and ensure that the product's ventilation outlets are unobstructed.
- Do not damage the refrigerant circuit.
- Do not stop the machine in the middle to take out the clothes. They must be taken out only after they have cooled down to prevent burns.
- This machine must not be connected to external power sources or circuits with arbitrary switches on public facilities at will to prevent personal injury.
- Make sure the drum has completely stopped before removing the clothes from the dryer.
- When the dryer is in operation, children and pets should stay away to ensure they are not trapped or injured. Before closing the door, be sure to carefully check the rollers to ensure that they won't get trapped and injured.
- Lint must not be allowed to accumulate around the tumble dryer.

### Other explanations

- This machine is designed for household use and cannot be used for any purpose other than this design.
- Do not dry fabrics other than those permitted by this product, and follow the instructions on each clothing label.
- Any electrical work required for the installation of this machine should be carried out by a qualified electrician or a capable person.
- For appliances with ventilation openings at the bottom, the carpet must not clog the openings.
- Do not climb onto the dryer. Do not place heavy objects with water or liquid leakage, nor items with heating devices, to prevent the panel and plastic parts from deforming.
- Do not put sharp and hard materials such as coins, pins, nails, screws or stones in the bucket. Because it may cause damage to the dryer.
- After installing this machine, check whether it is pressed against its power cable or drainage hose.
- Foam rubber (latex foam), shower caps, waterproof textiles, items lined with rubber, clothes or pillows with foam rubber pads and other items should not be dried in a dryer.
- After use, the power supply should be cut off and the machine should be cleaned and maintained.
- Do not overload the machine. Please refer to the recommended load in the manual for use.
- Wet clothes should not be put in the dryer.
- Do not use the dryer if the control panel, workbench or base is damaged.
- If industrial chemicals (such as flammable, corrosive or conductive cleaning liquids) are used to clean this product, please stop using it.
- Please do not take out the clothes directly before the program is completely over to avoid scalding.



## SAFETY NOTICE(be sure to observe)

- Please install the dryer in an environment where the door can be fully opened, clean, dry and free of flammable materials for use.
- When using a dryer, to minimize vibration and noise, it should be placed on a stable and flat surface.
- If the dryer is not completely flat, the front feet need to be adjusted. Rotate counterclockwise to lower the dryer and clockwise to raise it until it stops shaking.
- Sufficient ventilation space must be provided to prevent the gas flowing back from the product from entering and igniting other substances.
- Clothes mixed with acetone, detergent, turpentine, wax or wax remover, etc. should all be washed and dehydrated in hot water with detergent before being put into the dryer for drying.
- Make sure not to leave things such as matches and lighters in your clothes and bring them into the dryer.
- Clothes stained with oil should not be put into the dryer.

## CLEANING AND MAINTENANCE

 **WARNING:** Ensure that the appliance is switched off and disconnected from the power supply before performing any maintenance operation; never use steam cleaning equipment -risk of electric shock.

## DISPOSAL OF PACKAGING MATERIALS

 The packaging material is recyclable and is marked with the recycle symbol  . The various parts of the packaging must therefore be disposed of responsibly and in full compliance with local authority regulations governing waste disposal.

## DISPOSAL OF HOUSEHOLD APPLIANCES

 This appliance is manufactured with recyclable or reusable materials. Dispose of it in accordance with local waste disposal regulations. For further information on the treatment, recovery and recycling of household electrical appliances, contact your local authority, the collection service for household waste or the store where you purchased the appliance. By ensuring this product is disposed of correctly, you will help prevent negative consequences for the environment and human health.

The symbol  on the product or on the accompanying documentation indicates that it should not be treated as domestic waste but must be taken to an appropriate collection center for the recycling of electrical and electronic equipment.

## INSTALLATION INSTRUCTIONS

### Unpack the machine

Before using this machine, all packaging must be removed, the foam on the transportation safety packaging must be cleared, and it should be kept away from the reach of children.

#### Remove foams inside the drum.

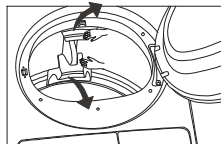

1. Open the machine door.
2. Take out two packaging foams from the drum.



**There are two packaging foams inside the drum. To prevent the belt from breaking, the foams must be removed before operation.**

# INSTALLATION INSTRUCTIONS

## Installation and Horizontal adjustment



**Warning** The temperature of the hot air generated by this machine during operation can reach 60°C. Therefore, this machine cannot be installed on the ground that cannot withstand high temperatures.

### Horizontal adjustment

When placing the dryer, you can press the diagonal position on the top cover plate with your hand to see if there is any shaking.

If the dryer is not in a horizontal position, The adjustable feet can be adjusted to level the dryer

Do not insert wooden chips or other objects under the adjusting feet for adjustment.



Adjustable feet

### Drainage modification

If you do not want the condensate water to be pumped into the water tank, you can drain it out by connecting the attached drainage pipe directly to the sewer. The operation is as follows:

Pull out the drain pipe in the direction of the arrow in Figure 1 (if it is difficult to do so, please use a pair of pointed-nose pliers). At the same position, connect the included drain pipe properly (See Figure 2), and then place the other end of the drain pipe at the inlet of the sewer.

If you have any difficulties, please have a professional install it.



Figure 1



Figure 2

### Warning

The minimum distance that the machine needs to keep from the wall is as follows

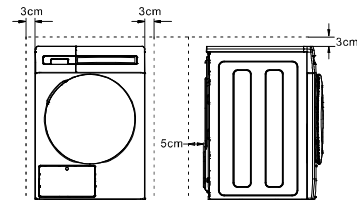

# SPECIFICATION SHEET

Dryer model	HWEC8002IG   HWEC8002IW
Dryer capacity	8kg
Voltage frequency	220-240V/50Hz
Rated power	650W
Net Weight(kg±10%)	49kg
Dimensions (Width x Depth x Height)	595x650x848mm
Ambient temperature range	5~35°C

### Dimension(mm)

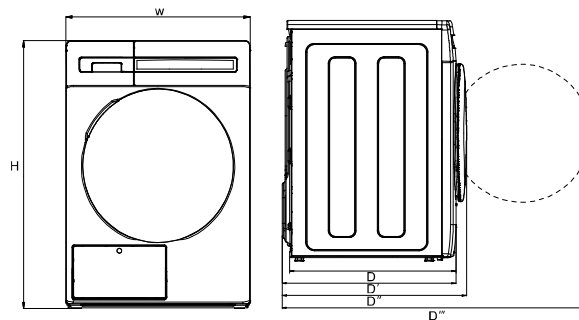

W	595	D	586
H	848	D'	613
		D''	650
		D'''	1088

## NAME OF PARTS

1. Water tank
2. Operation panel
3. Door frame filter screen
4. Machine door
5. Filter
6. Lower panel
7. Adjust the foot

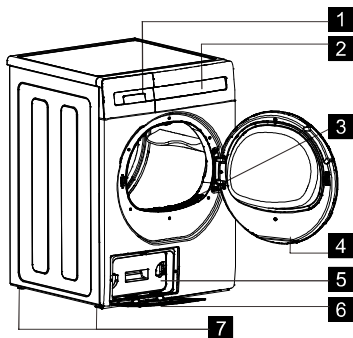

## ACCESSORIES

Instruction manual	Drainage pipe

## DOOR

Push to close the door.

The <img alt="Door closed icon" data-bbox="85 745 100 760"/> will light up when the door is closed properly.

If the door is not closed properly,

the <img alt="Door not closed icon" data-bbox="85 775 100 790"/> will flash with an alert,

<img alt="Door not closed icon" data-bbox="85 795 100 810"/> error code will be shown.

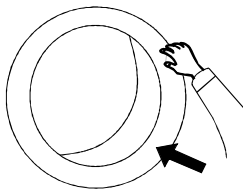

## INTRODUCTION TO CONTROL PANEL

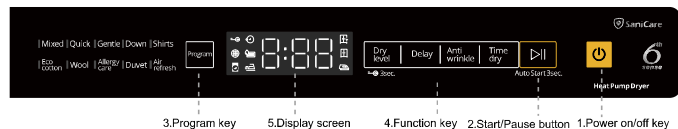

### 1. Power on/off key

- This is for turning on/off the machine.
- When the program finishes, machine will switch off automatically.

### 2. Start/Pause button

- Press button once to start and press again to pause.



### 3. Program key

- Choose a suitable program according to types of clothing or fabric.
- This product is equipped with a humidity sensor function and can automatically adjust the drying time to achieve the best drying effect. This automatic control system is not applicable to the "Quick" and "Air refresh" programs.

### 4. Function key

#### • Dry level:

Before starting the machine, you can choose the drying intensity. The drying intensity available for different programs varies, and the drying degree selection for some programs is restricted. The drying intensity is divided into three levels:

(  Extra    Cupboard    Iron )

#### • Time dry :

In standby or scheduled operation mode, the drying time can be selected based on the actual situation.

The default drying time is 20 minutes. Each time the "Time dry" key is pressed, the drying time increases by 10 minutes.

The selectable cycle range is from 20 minutes to 210 minutes.

The timing function of some programs is restricted.



**Warning**

Some thick clothes (jeans, large sweaters) are difficult to dry in some places due to the material properties.

If you find that they are not completely dry at the end of the program, it is recommended to use the "Time dry" function to dry them again.

## INTRODUCTION TO CONTROL PANEL

### • Anti wrinkle :

In standby or scheduled operation mode, the Anti-wrinkle function can be selected. Some programs might limit the activation of Anti-wrinkle function. During the Anti-wrinkle stage, the indicator light will flash. Manually opening the door or pressing the Start/Pause key can prematurely end the Anti-wrinkle stage. The Anti-wrinkle indicator light will go out and display "END". (Note: The default Anti-wrinkle time is 10 minutes. After selecting the Anti-wrinkle function, the Anti-wrinkle time increases to 120 minutes.)

### • Delay:

After pressing the "Delay" button, the maximum delay time you can make is 24 hours. The "Delay" button is only available in standby mode. This function must be used after selecting the program and before pressing "▶||" to begin drying. Each press of the "Delay" button increases the delay start time by 1 hour. The delay start time can be selected within the range of 1 to 24 hours. When "▶||" is pressed, the delay function is activated, the corresponding indicator icon will flash, and the countdown begins.

## 5. Display screen

The display screen shows the following information:

### • Display the remaining time :

After selecting the program, the display screen will show the remaining time of the program (in hours and minutes).

The display screen will automatically time according to different types of fabrics and the required degree of drying.

After the program starts, the display screen will show the remaining time and switch the display every minute.

### • Display the delay time :

If you select the delay start time, the display will show the remaining delay start times. As long as you press the "▶||" button, this machine will start running at the selected scheduled time.

## PROGRAMME CHART

### Laundry weights:

Cotton quilt (double layer)	1500g	Women's shirt	150g
Cotton quilt (double layer)	1000g	Cotton shirt	300g
Bed sheet (double layer)	500g	Shirt	250g
Bed sheet (single layer)	350g	Cotton skirt	500g
Large tablecloth	700g	Formal dress	350g
Large tablecloth	250g	Jeans	700g
Rag	100g	Handkerchief	100g
Bath towel	700g	T-shirt	125g
Hand towel	350g		

## PROGRAMME CHART

Programme	Application	Max load
Mixed	Ideal for drying clothes in cotton, linen, synthetics, fibres and mixed fibres.	4.0kg
Eco cotton	<b>Standard cotton programme, suitable to dry normally wet cotton laundry.</b> <b>Most efficient programme in terms of energy consumption for drying cotton laundry.</b>	8.0kg
Quick	Suitable for drying small amount of cotton clothes after high-speed spin drying in washing machine.	0.5kg
Wool	Suitable for wool garments.	1.0kg
Gentle	Ideal for drying of delicate fabrics.	5.0kg
Allergy care	Effective in removing bacteria and allergens. Ideal for cotton or mixed fabrics.	4.0kg
Down	For drying down clothings.	2.0kg
Duvet	Ideal for drying large clothing items, bed sheets or quilts.	2.0kg
Shirts	Suitable for cotton, synthetic and blended fabrics.	3.0kg
Air refresh	This program uses fresh air to refresh garments by removing bad odours. Not recommended for damp clothes.	0.5kg

**Eco cotton: is the test programme in accordance with AS/NZS 2442.1 and AS/NZS 2442.2. Tested at rated load capacity and dryness level Cupboard Dry.**

## FIRST-TIME AND DAILY USES

### First use

- Ensure that the electrical connections comply with the installation instructions.
- Remove foam blocks, and other accessories from the roller.
- Before using the dryer for the first time, it is recommended that you place a few wet cloths inside the machine and let them dry for 30 minutes, as there may be dust inside a brand-new dryer.

### Daily use

- Open the door.
- Please put the clothes into the drum one by one.
- Close the door and check if the clothes are stuck between the door or the filter screen of the door frame.
- After pressing the power button "⏻" to start, Select the corresponding program and press the start key "▶||".

## OTHER FUNCTIONS

### AUTO START 3 sec.

During shutdown state, long press 3sec on the "▶||" button to activate Auto Start (Mixed program).

### CHILD LOCK FUNCTION

In the running state, user can activate the Child Lock function by long press 3sec on the "Dry level" key. To deactivate, repeat the steps again. The child lock function will be automatically released under the following circumstances:

- Open the door
- Remove the filter
- The water tank is full
- The program malfunctions or ends.

## HINTS AND TIPS

### Drying hints

- Don't over-dry laundry, this avoids creasing and saves energy.
- Avoid drying dark clothes with light coloured fluffy items such as towels as they could attract the fluff.
- The laundry must be thoroughly spun before tumble drying.
- Easy-care items, too, e. g. shirts, should be briefly pre-spun before drying.
- Knitted textiles (knitted underwear) may shrink a little during drying. Please do not over-dry items of this type.

It is advisable to allow for shrinkage when choosing the size of new purchases.

- You can also put starched items into your dryer. To remove any starch residues, wipe out the internal drum after drying with a moist cloth and then rub it dry.
- To avoid a static charge when drying is completed, use either a fabric softener when you are washing the laundry or a fabric conditioner specifically for tumble dryers.
- Remove the laundry when the dryer has finished drying.
- If individual items are still damp after drying, set a brief post-drying time, but at least 30 minutes. This will be necessary particularly for multilayered items (e.g. collars ,pockets, etc.)
- When putting clothes into the machine, all the metal objects inside (such as hair clips, safety pins, pins, etc.) should be taken out.
- Turn the double-layer fabric clothes inside out (for example: if it is a cotton-lined trench coat, the cotton layer should be the outermost one). This can dry better.
- Take out all the items from the pocket, such as lighters and matches.
- Fabric softeners, or similar products, should be used as specified by the fabric softener instructions.

Never tumble dry the following :Particularly delicate items such as net curtains ,woolen ,silk , fabrics with metal trim, nylon tights ,bulky materials such as anoraks ,blankets, eiderdowns, sleeping bags, feather quilts and any items containing rubber foam or materials similar to rubber foam .

#### Always follow the instructions on garment labels:

- |  |  |
|--|--|
|  May be tumble died              |  Delicate drying(low temperature) |
|  Normal drying(high temperature) |  Do not tumble dry                |

- Close pillowcases and covers with fasteners to prevent small laundry items getting tangled inside them.
- Close press studs, zips and hooks and tie belts and apron strings. Sort laundry according to type and degree of drying required.

### Usage Tips









#### 1. Change the program

- If the program is in standby mode, press the "Program" key to select a new program.
- If the program is in the running or paused stage, reselecting the program is not supported.

#### 2. The program ends

- After the drying process is completed, some programs will immediately execute the default anti-wrinkle function for 10 minutes, with the anti-wrinkle indicator light flashing. At this stage, opening the door or pressing the start/pause button can prematurely end the anti-wrinkle state.
- After the program ends, the display screen shows "End", the end prompt sound sounds three times, the filter screen cleaning icon and the water collection box reminder icon light up, and all other ICONS go out.
- In the end state, you can return to the standby state and start a new drying program by pressing the program selection button. After the program ends, if there is no operation within 10 minutes, it will automatically enter the shutdown state. After use, please clean the door frame filter screen and empty the water tank.

## INDICATORS

	Child lock	After child lock function activated,this indicator will light up,all buttons (except for power button) will be locked.
	Delay	After select delay function,this indicator will light up. During running,this indicator will flash.
	Filter screen cleaning	This indicator will light up,prompt you to clean the door frame filter screen after each program end.
	Water Tank	This indicator will light up to remind you to empty the water tank after each program ends. This indicator will flash when the water tank is full. <b>Attention! After each program end , the water tank should be emptied to avoid an alarm when used next time.</b>
	Door Close	This indicator will light up when the door is closed properly. If the door is not closed properly, the indicator will flash with an alert, <do> error code will be shown.
	Anti-wrinkle	This indicator will light up after select anti-wrinkle function. During the anti-wrinkle stage,the indicator will flash.
	Extra	This indicator will light up when set Extra drying level.
	Cupboard	This indicator will light up when set Cupboard drying level.
	Iron	This indicator will light up when set Iron drying level.

## CLEANING AND MAINTENANCE

- You must DISCONNECT the appliance from the electricity supply, before you can carry out any deaning or maintenance work.
- Do not clean the dryer by directly spraying water. Clean with soapy water and dry thoroughly. Do not clean the dryer with benzene, thinner, alcohol ,acetone or similar products. Otherwise, it may cause discoloration, deformation, damage, electric shock or fire.
- During the drying period, moisture may accumulate on the control panel or door. When cleaning the product, please be sure to unplug the power cord.

### Control panel

- Clean with a soft and damp cloth. Do not use abrasive substances.
- Do not spray the cleaner directly on the panel.
- The surface of the control panel may be damaged by some dust and cleaning agent products.
- Please immediately wipe off any spilled or over-sprayed detergent and keep these products away from your dryer.

## CLEANING AND MAINTENANCE

### Stainless steel products

- When cleaning stainless steel products, use a damp cloth and a mild, non-corrosive cleaner suitable for the stainless steel surface.
- Please dry the residue of the cleaner with a clean cloth.

### Cleaning the door

- Clean periodically the interior part of the door to remove any fluff. Accurate cleaning ensures correct drying.



### Outside the dryer

- The exterior of the dryer has a high gloss. Clean with a soft damp cloth. Do not use abrasive substances. Protect the surface from being scratched or damaged by sharp objects.
- Do not place any heavy or sharp items or any leaky liquids on the dryer.

### Clean the filter screen of the door frame

- Open the door, take out the door frame filter screen, and then open the door frame filter screen.
- Clean the cotton fluff, fibers and cotton by hand or with a soft cloth. Turn off the door frame filter screen and put it back.

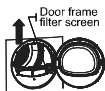

**Warning** After each drying program is completed, please clean the door frame filter screen immediately. If the filter screen is clogged, it may cause abnormal vibration during machine operation or fail to dry properly

### Empty the water tank

The water tank needs to be emptied after each drying cycle. If the water tank is full, the program will pause. The lights  will flash and the buzzer will sound. Please empty the water tank immediately

- Take out the water tank
- Pour water into the sink
- Put it into the water tank
- Press the start/pause button

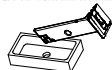

### Humidity sensor

Please regularly wipe the lint and impurities on the surface of the humidity sensor with a dry and soft cotton cloth to ensure the normal operation of the machine.



### Clean the filter

Please make sure to clean the filter every three months. Because the lint clogs the filter screen and the filter screen sponge of the filter, it may cause the dryer to vibrate during operation. Abnormal or not dry properly. The specific operation is as follows:

## CLEANING AND MAINTENANCE

- Press the button on the lower panel to open the lid.
- Unfasten the fixator.
- Take out the filter.
- Clean the lint and impurities on the filter screen by hand or with a soft cloth, and then rinse the filter screen sponge with clean water.
- After the filter screen sponge is dried, reinstall it into the filter tank.

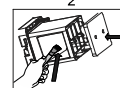
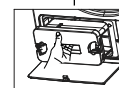
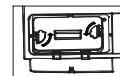
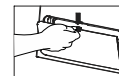

### Clean the evaporator

- Clean the accumulated lint on the evaporator behind the filter with a vacuum cleaner or a soft brush. If you wear protective gloves, you can also clean it by hand.
- It is recommended to clean at least twice a month.



**Warning** Never try to clean it by hand. The evaporator can hurt your hands!



## NO-FAILURE CONDITION

Malfunction	Possible Cause	Solution
Dryer does not work	Mains plug is not plugged in.	Plug in at main socket.
	Loading door is open.	Close loading door.
	The filter is not installed properly.	Install the filter properly.
	The filter screen of the door frame is not installed properly.	Install the filter screen of the door frame properly.
Drying results unsatisfactory	Have you pressed the <b>▶  </b> button?	Press the <b>▶  </b> button again.
	Wrong programme selected.	Select a different programme the next time you dry (see "Drying Programme" section).
	The filter screen of the door frame is clogged.	Clean the filter screen of the door frame.
	Filter clogged.	Clean lint filter.
	Incorrect volume of laundry.	Observe recommended loading volumes.
Drying cycle ends shortly after programme starts	The sediment on humidity sensor.	Washed humidity sensor surface.
	Drying load is too little or too dry for the selected programme.	Select Time dry function or a higher drying level (e.g. Extra instead of Iron).
Drying cycle lasts an unusually long time	Load volume is too big.	Reduce load volume.

## TROUBLESHOOTING GUIDE

Display screen alarm code	Fault description	Fault conditions	Possible causes of failure	Treatment method
dOP	Filter prompt	The filter is not installed properly	1.The filter lock is not installed properly. 2.The terminals of the microswitch wiring harness are loose or the wiring harness is faulty. 3.The microswitch device is damaged. 4.Computer board malfunction.	1.Install the filter lock properly. 2.Check whether the terminals of the wiring harness are firmly connected or replace the wiring harness. 3.Replace the microswitch. 4.Replace the computer board.
	Door lock malfunction	After startup, the door was not locked	1.The door wasn't closed properly. 2.The terminal blocks are not properly inserted or the wiring harness is faulty. 3.Door lock malfunction. 4.Computer board malfunction.	1.Check if the door is closed properly. 2.Check whether the terminals of the wiring harness are firmly connected or replace the wiring harness. 3.Replace the door lock. 4.Replace the computer board.
	Door frame filter screen Hint	The filter screen of the door frame is not installed properly	1.The filter screen of the door frame was not installed correctly. 2.The magnet of the door frame filter screen is damaged or fallen off. 3.Fault in the reed switch circuit. 4.Computer board malfunction.	1.Install the door frame filter screen properly. (Pay attention to the installation direction). 2.Check if the magnet is damaged or fallen off. 3.Check the reed switch circuit and the terminal blocks. 4.Replace the computer board.
E1	Temperature sensor -Air outlet	The sensor is open circuit or short circuit	1.The terminal blocks are not properly inserted or the wiring harness is faulty. 2.Computer board malfunction. 3.Sensor failure.	1.Check whether the terminals of the wiring harness are firmly connected or replace the wiring harness. 2.Replace the computer board. 3. Replace the sensor.
E3	Temperature sensor -Compressor	The sensor is open circuit or short circuit		
E2	Low-temperature failure	The temperature was detected to be lower than-10 after startup	1.The terminal blocks are not properly inserted or the wiring harness is faulty. 2. The ambient temperature is too low. 3.Computer board malfunction.	1.Check whether the terminals of the wiring harness are firmly connected or replace the wiring harness. 2.Change the placement of the machine. 3.Replace the computer board.

## AFTER-SALES SERVICE

### BEFORE CALLING THE AFTER-SALES SERVICE

1. See if you can solve the problem by yourself with the help of the suggestions given in the "Troubleshooting Guide" section.
2. Switch the appliance off and back on again to see if the fault persists.

### IF AFTER THE ABOVE CHECKS THE FAULT STILL OCCURS, GET IN TOUCH WITH THE NEAREST AFTER-SALES SERVICE

When contacting our After-sales service, always specify:

- a brief description of the fault;
- the type and exact model of the appliance;
- your full address;
- your telephone number.

If any repairs are required, please contact an authorised after-sales service (to guarantee that original spare parts will be used and repairs carried out correctly).