

*Fisher & Paykel*

**ActiveSmart™ refrigerator**

Ice & Water and non-Ice & Water  
E372B, E402B, E442B &  
E522B models

RF372B, RF402B, RF442B, RF522B,  
RF522W, RF522A, RF610A &  
RF540A models

**Installation instructions  
and User guide**

NZ AU GB IE EU AE HK SG





Introduction	2
Safety and warnings	3
Installation instructions	7
Moving or storing your appliance	21
Soft closing door	22
ActiveSmart™ operating instructions	23
External display (Ice & Water models)	27
Using your water dispenser (Ice & Water models)	28
Water filter (Ice & Water models)	29
Using your ice maker (Ice & Water models)	31
Manual ice system (non-Ice & Water models)	33
ActiveSmart™ special features (all models)	34
Cleaning care – Exterior	36
Cleaning care – Interior	38
Cleaning care	39
Storing food in your refrigerator	41
Storing food in your freezer	43
Defrosting food in your refrigerator	45
User warnings and sounds	46
Troubleshooting	47
Manufacturer's Warranty	51
Customer Care	53
European directive 2012/19/EU on Waste Electrical and Electronic Equipment (WEEE)	55
Filter performance data sheet	56

---

## **Important!**

### **SAVE THESE INSTRUCTIONS**

*The models shown in this User Guide may not be available in all markets and are subject to change at any time. For current details about model and specification availability in your country, please visit our website listed on the back cover or contact your local Fisher & Paykel dealer.*

*Note that the word "refrigerator", throughout this User Guide, refers to combination refrigerator/freezer products.*

### **Registration**

*Register your product with us so we can provide you with the best service possible.*

*To register your product visit our website:  
[www.fisherpaykel.com](http://www.fisherpaykel.com)*

## 2 Introduction

Thank you for buying a Fisher & Paykel *ActiveSmart™* refrigerator.

At Fisher & Paykel we are very proud of this refrigerator. This refrigerator combines size and storage space with the latest features and functions.

Thousands of hours of food care research and refrigeration experience has been programmed into your refrigerator to give you the best possible performance.

We hope you enjoy your new refrigerator.

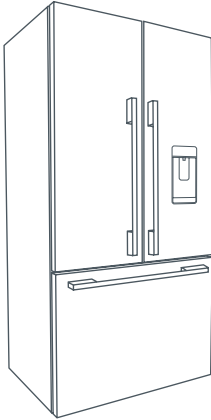

Refrigerator French door  
and freezer drawer

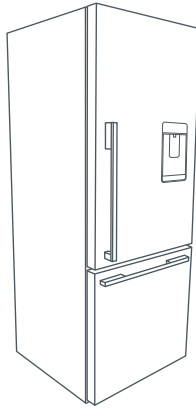

Refrigerator door  
and freezer drawer

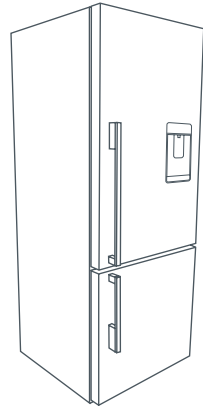

Refrigerator door  
and freezer door

Note: non-Ice & Water models do not have an external water dispenser.

**⚠ WARNING!****Electric Shock Hazard**

Read and follow the SAFETY AND WARNINGS outlined in this User Guide before operating this appliance.

Failure to do so can result in death, electric shock, fire or injury to persons.

**R600a**

This refrigerator contains flammable refrigerant isobutane (R600a).

Use this appliance only for its intended purpose as described in this User Guide.

## ***Important safety precautions***

### **Warning**

*When using this appliance always exercise basic safety precautions including the following:*

- *This appliance is not intended for use by persons (including children under the age of 8 years) with reduced physical, sensory or mental capabilities, or lack of experience and knowledge, unless they have been given supervision or instruction concerning use of the appliance by a person responsible for their safety.*
- *Young children should be supervised to ensure they do not play with the appliance.*
- *The manufacturer's installation instructions for product and cabinetry ventilation must be followed when installing the appliance.*
- *To avoid hazard due to instability of the appliance refer to the stability bracket and leaflet supplied.*

## 4 Safety and warnings

- *Keep ventilation openings, in the appliance enclosure or in the built-in structure, clear of obstruction.*
- *Do not use mechanical devices or other means to accelerate the defrosting process.*
- *Do not damage the refrigerant circuit.*
- *In case of damage to the refrigerant circuit, ventilate the area by opening all windows. Do not operate electrical equipment or any other equipment that may produce arcs, sparks or flames in the area. Contact your Fisher & Paykel Authorised Repairer immediately to arrange for the appliance to be repaired.*
- *It is hazardous for anyone other than an authorised service person to service this appliance. In Queensland the authorised service person must hold a gas work licence or authorisation for hydrocarbon refrigerants to carry out service or repairs which involve removal of covers.*

### Electrical

- *This appliance must be installed in accordance with the installation instructions before use.*
- *To allow disconnection of the appliance from the supply after installation, incorporate a switch in the fixed wiring in accordance with the wiring rules.*
- *Never unplug your refrigerator by pulling on the power cord. Always grip the plug firmly and pull straight out from the outlet.*
- *Do not plug in any other appliance at the same power point as your refrigerator or use extension cords or double adapters.*
- *Repair or replace immediately all electric service cords that have become frayed or otherwise damaged. Do not use a cord that shows cracks or abrasion along its length or at either the plug or appliance end.*
- *If the power supply cord is damaged, it must only be replaced by your Fisher & Paykel Authorised Repairer because special purpose tools are required.*

- *When moving your appliance away from the wall, be careful not to roll over or damage the power cord.*
- *Do not use electrical appliances inside the food storage compartments of the appliance.*

## ***Important!***

*Your refrigerator is designed to operate for many years without the need for service checks. However, if your refrigerator is malfunctioning, have it attended to by your Fisher & Paykel Authorised Repairer as soon as possible. All electrical repairs must be carried out by an adequately trained service technician or qualified electrician.*

## **Cleaning**

- *Many commercially available cleaning products contain solvents that may attack the plastic components of your refrigerator and cause them to crack.*
- *Avoid using anti-bacterial cleaning products on either the interior or exterior of the cabinet as they may cause rusting of metal components and cracking of plastic components.*
- *Please refer to the 'Cleaning care' section of this user guide for further information.*

## **Disposal**

- *Extreme care must be taken when disposing of your old appliance to avoid hazards:*
  - *The flammable refrigerant gas must be safely removed.*
  - *The thermal insulation foam in this appliance contains flammable insulation blowing gases, any exposed foam may be highly flammable and must be carefully treated during disposal.*
  - *The doors and panels should be removed and the shelves left in place so that children may not easily climb inside.*

## 6 Safety and warnings

- *Your Fisher & Paykel Authorised Repairer will be able to give advice on environmentally friendly methods of disposing of your old refrigerator or freezer.*

### Storing food and drinks

- *Do not store explosive substances such as aerosol cans with a flammable propellant in this appliance.*
- *Never store volatile or flammable materials in your refrigerator as they may explode.*
- *Never freeze liquids in glass containers. Liquid expands during freezing, which may cause the container to explode.*
- *Never freeze carbonated drinks. They may explode.*
- *Do not consume food if it is too cold. Food removed from the freezer compartment may be cold enough to cause damage when brought into contact with bare skin, eg frozen ice cubes.*

### Power failure – food safety

- *Do not refreeze frozen foods that have thawed completely. The food may be dangerous to eat. Follow the recommendations below if you discover food in your freezer has thawed:*
  - *Ice crystals still visible – food may be refrozen but should be stored for a shorter period than recommended.*
  - *Thawed but refrigerator cold – refreezing generally not recommended. Fruits and some cooked food can be refrozen but use as soon as possible. Meat, fish, poultry – use immediately or cook then refreeze. Vegetables – discard as they usually go limp and soggy.*
  - *Thawed and warmer than 5°C (41°F) – discard all food.*

Please follow the installation steps below to ensure your appliance operates correctly.

## Power

- The appliance must be installed so the plug is accessible.
- To ensure that the appliance is not accidentally switched off, connect your refrigerator to its own power point. Do not plug in any other appliance at this power point or use extension cords and double adaptors, as the combined weight of both power cords can pull the double adaptor from a wall outlet socket.
- For power requirements, refer to the information on the serial plate located at the front bottom right-hand side of the refrigerator when the door is open.
- It is essential that the appliance is properly grounded (earthed).

## Location

- Your refrigerator should not be located in direct sunlight or next to any heat generating appliance such as a cooktop, oven or dishwasher.

## Ice & Water models

- Your Ice & Water refrigerator must be installed by an authorised plumber or Fisher & Paykel Authorised Repairer as incorrect plumbing can lead to water leaks.
- Fisher & Paykel Appliances does not accept responsibility for damage (including water damage) caused by faulty installation or plumbing.

### Ventilation and installation – Freezer door models (Ice & Water and non-Ice & Water)

- To ensure adequate ventilation for your refrigerator or vertical freezer, see recommended cabinetry dimensions below.
- If integrating your refrigerator, please follow installation instructions provided with the integration kits.

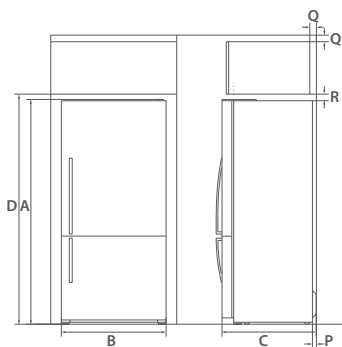

Flush with refrigerator chassis – full door rotation

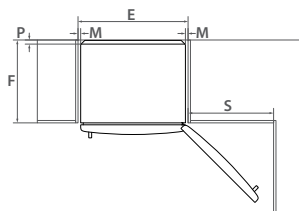

Flush with refrigerator door – full door rotation

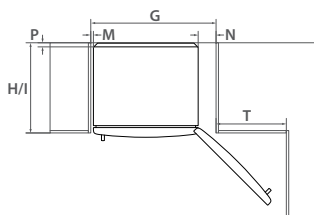

Flush with refrigerator door – 90° door rotation

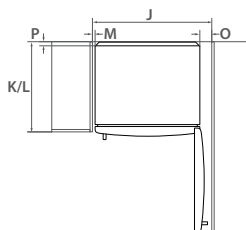

Note: these drawings and dimensions are also true for Ice & Water models.

Product dimensions (mm)	E372B RF372B	E402B RF402B	E442B RF442B	E522B RF522B
<b>A</b> overall height of flat door product	1620	1720	1720	1720
<b>A</b> overall height of curved door product	1595	1695	1695	1695
<b>A</b> overall height of curved door with Ice & Water product	n/a	n/a	n/a	1705
<b>B</b> overall width of product	635	635	680	790
<b>C</b> overall depth of flat door product (excludes handle, includes evaporator)	n/a	695	695	695
<b>C</b> overall depth of curved door product (excludes handle, includes evaporator)	715	715	715	715
<b>Cabinetry dimensions (mm) (including minimum clearances)</b>				
<b>D</b> inside height of cavity	1645	1735	1735	1735
<b>Flush with refrigerator chassis – full door rotation</b>				
<b>E</b> inside width	675	675	720	830
<b>F</b> inside depth	620	620	620	620
<b>Flush with refrigerator door – full door rotation</b>				
<b>G</b> inside width	790	790	835	945
<b>H</b> inside depth flush to curved door	680	680	680	680
<b>I</b> inside depth flush to flat door	n/a	695	695	695
<b>Flush with refrigerator door – 90° door rotation (for full drawer/shelf access, the doors need to be open past 90°)</b>				
<b>J</b> inside width	745	745	790	900
<b>K</b> inside depth flush to curved door	680	680	680	680
<b>L</b> inside depth flush to flat door	n/a	695	695	695
<b>Minimum clearances</b>				
<b>M</b> side clearance	20	20	20	20
<b>N</b> side clearance – hinge side flush with door – full rotation	135	135	135	135
<b>O</b> side clearance – hinge side flush with door – 90° rotation	90	90	90	90
<b>P</b> rear clearance (incl. evaporator tray)	30	30	30	30
<b>Q</b> vent – around top of cupboard (optional)	50	50	50	50
<b>R</b> top clearance – above refrigerator cabinet	50	50	50	50
<b>S</b> door clearance – hinge side flush with chassis – full rotation	520	520	555	645
<b>T</b> door clearance – hinge side flush with door – full rotation	405	405	440	530

Ventilation and installation – Freezer drawer models  
(Ice & Water and non-Ice & Water)

RF522W

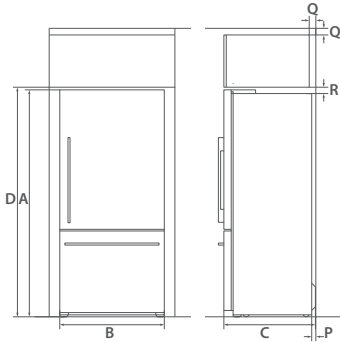

Flush with refrigerator chassis – full door rotation

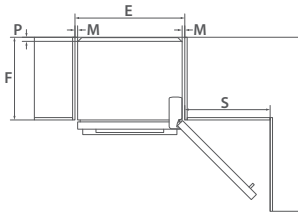

Flush with refrigerator door – full door rotation

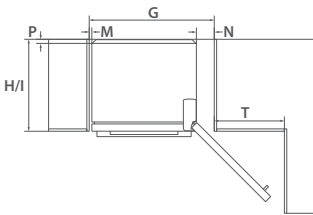

Flush with refrigerator door – 90° door rotation

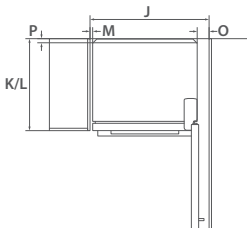

RF522A/RF610A/RF540A

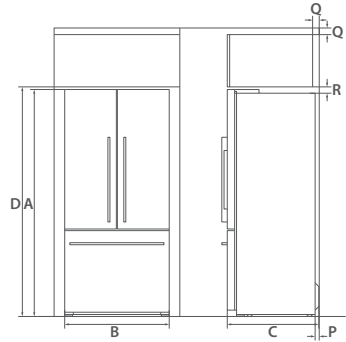

Flush with refrigerator chassis – full door rotation

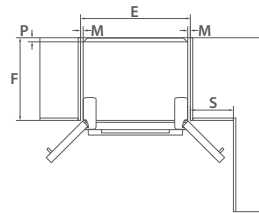

Flush with refrigerator door – full door rotation

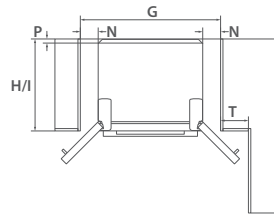

Flush with refrigerator door – 90° door rotation

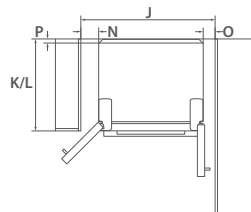

Note: these drawings and dimensions are also true for Ice & Water models.

To ensure adequate ventilation for your refrigerator see recommended cabinetry dimensions below.

Product dimensions (mm)	RF522W	RF522A	RF610/ RF540A
<b>A</b> overall height of product	1720	1720	1795
<b>B</b> overall width of product	790	790	900
<b>C</b> overall depth of product (excludes handle, includes evaporator)	695	695	695
<b>Cabinetry dimensions (mm) (including minimum air clearances)</b>			
<b>D</b> inside height of cavity	1735	1735	1810
<b>Flush with refrigerator chassis – full door rotation</b>			
<b>E</b> inside width	830	830	940
<b>F</b> inside depth	620	620	620
<b>Flush with refrigerator door – full door rotation</b>			
<b>G</b> inside width	945	1060	1170
<b>H</b> inside depth flush to curved door	–	–	–
<b>I</b> inside depth flush to flat door	695	695	695
<b>Flush with refrigerator door – 90° door rotation (for full drawer/shelf access, the doors need to be open past 90°)</b>			
<b>J</b> inside width	900	1015	1125
<b>K</b> inside depth flush to curved door	–	–	–
<b>L</b> inside depth flush to flat door	695	695	695
<b>Minimum clearances</b>			
<b>M</b> side clearance	20	20	20
<b>N</b> side clearance – hinge side flush with door – full rotation	135	135	135
<b>O</b> side clearance – hinge side flush with door – 90° rotation	90	90	90
<b>P</b> rear clearance (incl. evaporator tray)	30	30	30
<b>Q</b> vent – around top of cupboard (optional)	50	50	50
<b>R</b> top clearance – above refrigerator cabinet	50	50	50
<b>S</b> door clearance – hinge side flush with chassis – full rotation	645	325	365
<b>T</b> door clearance – hinge side flush with door – full rotation	530	210	250

## 12 Installation instructions

### Connecting water (Ice & Water models only)

#### Contents of filter kit

- 1 1 x 4 m (13 ft) long x Ø6 mm (¼") tubing
- 2 1 x 200 mm (8") short Ø6 mm (¼") tubing
- 3 1 x pressure reducing valve (PRV)
- 4 1 x double sided foam
- 5 2 x locking keys
- 6 1 x water filter cartridge and head
- 7 1 x tap connection – 15 mm (½") BSP

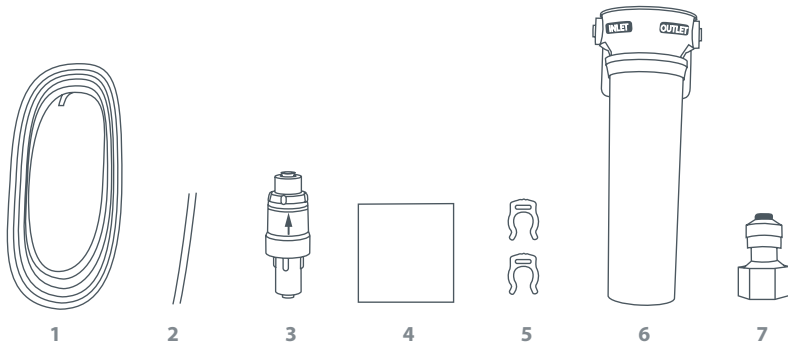

Water connection kit

### **Important!**

- *It is imperative the pressure reducing valve (PRV) is fitted prior to the filter. If the PRV is not fitted to the connection line, the Ice & Water features may not function in some circumstances.*
- *The water connection to your Ice & Water refrigerator must be installed by an authorised plumber or Fisher & Paykel Authorised Service Agent.*
- *The water connection instructions below are intended only for the professional installer.*
- *The new tubings supplied with the refrigerator are to be used, old tubings from old Ice & Water connections should not be used.*
- *Replacement parts are available through Customer Care or online at [www.fisherpaykel.com](http://www.fisherpaykel.com) (this service is available to selected markets only).*

## Installation precautions/warnings

- DO NOT use with water that is microbiologically unsafe or of unknown quality without adequate disinfection before or after the system.
- WARNING – connect to potable water supply only.
- DO NOT install on line pressure above 119 psi (827 kPa) or below 22 psi (150 kPa).
- DO NOT use on hot water supply (100°F [38°C max.]).
- DO NOT cut any length of tube shorter than 8" (200 mm).
- DO NOT install near electrical wires or water pipes that will be in the path of drilling when selecting the location of filter system.
- DO NOT mount filter in such a position so that it will be struck by other items, such as wastebaskets, etc.
- DO NOT install the filter or any water tubing in direct sunlight as prolonged exposure to light can weaken plastic components.
- DO NOT install in a location that is susceptible to freezing temperatures as damage to the housing could occur.
- DO NOT screw filter to the refrigerator.
- DO NOT install the filter or any water tubing in high temperature areas eg in a ceiling cavity.
- AVOID contamination of pipes during installation.
- DO NOT use copper tubing. The plastic tubing supplied should always be used.
- DO NOT continuously dispense water for longer than 2 minutes.

### Connecting your water filter cartridge

- 1 Ensure the refrigerator is not plugged into a power supply.
- 2 Locate isolation tap for water connection – cold water feed only (dishwasher or sink mixer taps). Tee and tap fitting not supplied.
- 3 Connect the short 200 mm (8") tubing to the outlet of the PRV (blue collet) and the inlet connection of the water filter cartridge (refer to Diagram 1). Gently pull on both ends to ensure it is locked.
- 4 Connect the long 6 mm (¼") tubing to the outlet of the water filter cartridge (refer to Diagram 2). Gently pull to ensure it is locked.
- 5 Measure the required length of tubing to run from the PRV to the water connection point (no less than 250 mm (10")).
- 6 Cut from the long tube making sure the ends are square and clean.
- 7 Connect the tubing to the tap connection and the base of the PRV (white collet) and then to the tap (refer to Diagram 3). Take care not to over-tighten the tap connection. Please note that the tap connection supplied should fit most installation situations.
- 8 Connect one locking key to each side of the water filter cartridge in between the cartridge and the locking collet (refer to Diagram 4).
- 9 To flush the water filter of any trapped air, harmless carbon fines and to also check for leaks, aim the end of the tubing into a bucket, turn isolating tap on and run at least 10 litres (10 qt) of water through. Once complete, turn isolating tap off.
- 10 Locate desired position for water filter noting carefully the following points:
  - It is recommended to fit the water filter in a vertical orientation with the water filter head at the top. This will minimise water leakage when replacing cartridge.
  - Ensure the filter is in a convenient location to access every 6 months for replacement. We suggest that this location is beside the water filter supply tap in a cupboard beside the refrigerator.
  - A minimum clearance of 64 mm (2½") from the bottom of the filter cartridge is required to perform cartridge removal.
  - Do not screw the water filter to the refrigerator.
- 11 Attach double sided foam to the back of the water filter head (refer to Diagram 5). Write the date to be replaced on the filter (date installed + 6 months). Remove double sided foam backing and attach filter to the desired position as located in step 10 (refer to previous page).
- 12 Run the 6 mm (¼") tubing to the back of the refrigerator ensuring there is enough tubing to pull the refrigerator out for service.

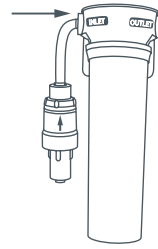

Diagram 1  
PRV connection

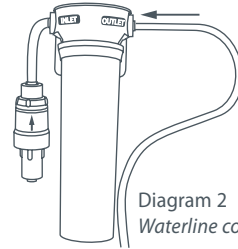

Diagram 2  
Waterline connection

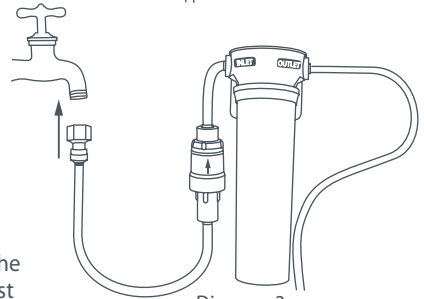

Diagram 3  
Tap connection

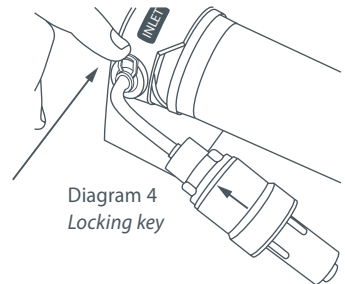

Diagram 4  
Locking key



Diagram 5  
Double sided foam attachment

## Important!

- All connections must be checked for leaks.
- Ensure 6 mm (¼") tubing is routed away from sharp objects, sharp corners (beware of kinking tube as this will stop water flow), clear of the refrigerator unit compartment and not in a location where it can be squashed.
- Ensure all push-fit connections are firmly pushed into place. The tube should be pushed in 16 mm (5/8") before reaching the stop.
- If tubing is removed at any point, re-cut the end and re-insert. Tubing must be fully inserted to avoid leaks.
- To remove tube from connection points, turn off the isolating tap, push in the collet and gently pull tubing at the same time (refer to Diagram 6).

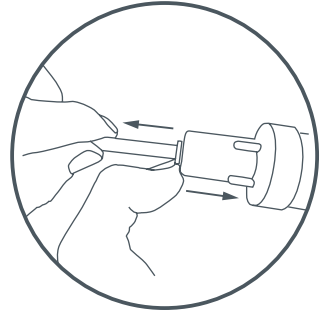

Diagram 6

## Open rear compartment installation

- 1 Mark a line of 16 mm (5/8") on the end of the tube. Firmly push the marked water tube into the water (solenoid) valve located on the right hand side of the rear compartment until the marked line is not visible (refer to Diagram 7). Beware of hot pipes.
- 2 Pull gently on tubing to ensure it is locked (refer to Diagram 8).
- 3 The completed installation should look like Diagram 9. Turn isolating tap on and check that all connections are dry and free of drips.
- 4 Coil water line tubing behind the refrigerator and push into position being careful not to kink or squash the water line running into the water (solenoid) valve.

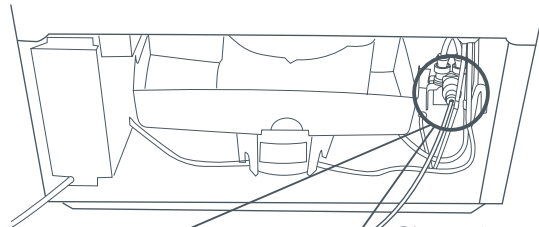
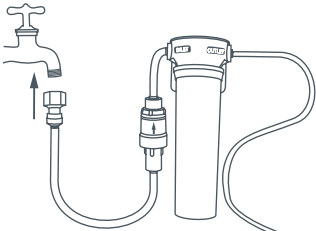

Diagram 9  
Completed installation

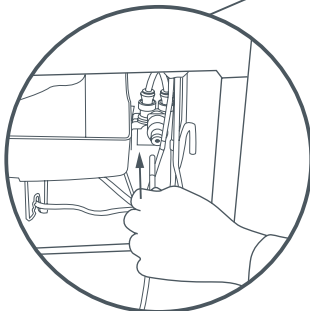

Diagram 7

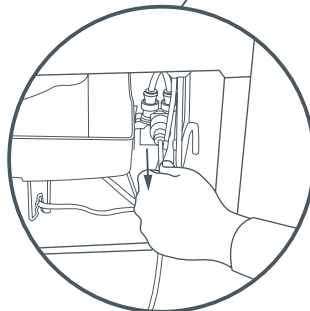

Diagram 8

## 16 Installation instructions

### Rear compartment cover installation

- 1 Using the measurement guide located on the rear compartment cover. Mark out 16 mm ( $\frac{5}{8}$ " ), on the end of the tubing (refer to Diagram 10).
- 2 Firmly insert the marked water tube into the water (solenoid) valve until the marked line is not visible (refer to Diagram 11).
- 3 Pull gently on tubing to ensure it is locked (refer to Diagram 12).
- 4 The completed installation should look like Diagram 13. Turn isolating tap on and check that all connections are dry and free of drips.
- 5 Coil water line tubing behind the refrigerator and push into position being careful not to kink or squash the water line running into the water (solenoid) valve.

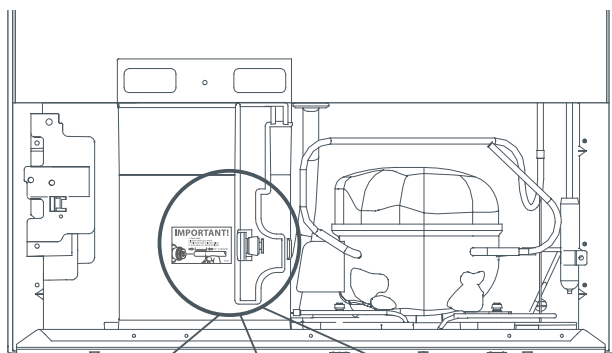

Diagram 13  
Completed installation

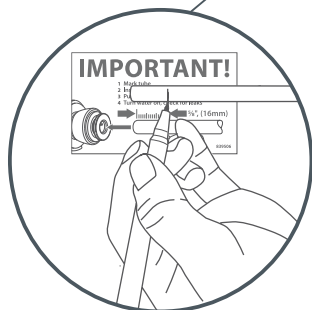

Diagram 10

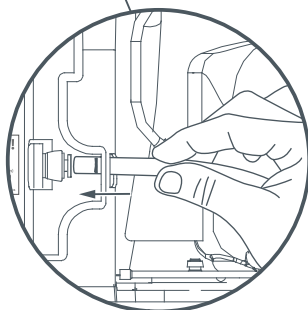

Diagram 11

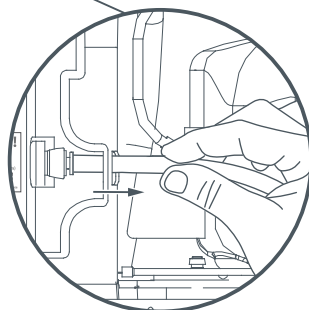







Diagram 12

The water filtration system is tested and certified by NSF International against NSF/ANSI Standard 53 for the reduction of Asbestos, Atrazine, Benzene, Cyst, Carbofuran, Lead, Lindane, Mercury, P-Dichlorobenzene, Toxaphene & Turbidity; against Standard NSF/ANSI 42 for the reduction of Chlorine Taste and Odour and Nominal Particulate Class I to a capacity of 2,838 Litres (750 gallons).

## Before you start using your Ice & Water refrigerator

### To flush the water filtration system

- Ensure your refrigerator is switched on, and the isolation tap has been connected and turned on.
- Run your water dispenser pad until water dispenses, this will displace trapped air in the water tank and filter system. This will take at least 2 minutes. Once water has dispensed, rest the dispenser pad for 2 minutes.
- Dispense and discard 4 litres (4 qt) of water, then rest the dispenser pad for a further 2 minutes.
- Dispense and discard a further 4 litres (4 qt) of water. Failure to do this will result in excessive dripping from your dispenser.
- Please note, once installation is complete a few drips may appear out of the dispenser over the next few days to clear the remaining trapped air.
- Turn the ice maker on by pressing the  button. The light above the  button will be illuminated when the ice maker is on.
- Press and hold the ,  and  buttons together for 4 seconds and then close the refrigerator compartment door to force an ice maker cycle. The ice tray will flip twice. Repeat to force another ice maker cycle. The ice tray will flip twice and spill water into the ice bin. Empty the water, dry and replace the bin. Note that the ice tray will not flip until the refrigerator compartment door is closed.
- Please discard the first 3 harvests of ice (8 cubes per harvest).
- Ensure your refrigerator has cooled for at least 2 hours before use.

You are now ready to enjoy ice and water from your refrigerator.



Water dispenser

## 18 Installation instructions

Your Fisher & Paykel *ActiveSmart*™ refrigerator is fitted with front and rear rollers, designed for moving the product in the forwards and backwards direction.

Avoid moving the product in a sideways direction as this may damage the rollers or the floor covering/surface.

- A** Your refrigerator will arrive with the front feet wound up making moving the product into its final location a simple task.
- B** Roll the refrigerator into its final position making sure there is the correct air gap between the product and surrounding cabinetry.
- C** Adjust the front feet down until the refrigerator is leaning backward with the front approximately 10 mm (½") higher than the back. This will ensure a good door closing action.
- (Non French door models only)**
- D** Aligning your refrigerator with cabinetry.
- Align the sides of the refrigerator with the cabinetry by adjusting the hinge side front foot.
  - Adjust the handle side foot until it touches the floor and takes a small amount of weight.
  - Once the refrigerator is in place and aligned with cupboards/alcove gently push on the front top and check if the product is rocking or stable.

### Levelling of refrigerator doors (French door models only)

- For uneven surfaces, front feet can be used to align the 2 doors.
- If left hand door is too low, then unscrew the left hand foot to lift up the cabinet until the two doors top edges are aligned.
- If right hand door is too low, then adjust the right hand foot in the same way.

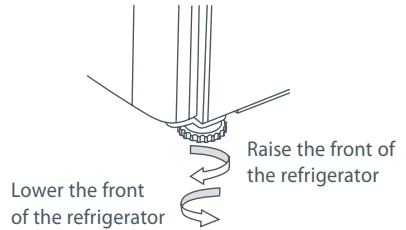

*Adjusting refrigerator feet*

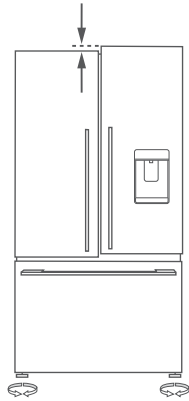

*Uneven door alignment*

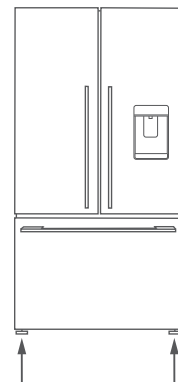

*Even door alignment*

## What to do if your product is unstable

- A** Gently push the refrigerator back until the rear rollers contact the floor.
- Measure the gap under the front foot, which has come off the floor.
  - Obtain some solid packing material (hardwood, plastic, etc) which fits firmly into the gap under the foot.

Note: do not use metallic materials that may corrode, stain and/or damage floor coverings.

- B** Wind both front feet up and roll the product out of position.
- Place the packing material in the location diagonally opposite the front roller that lifts off the floor.
  - Make sure the packing material stays in place when the product is pushed back into position.
  - Ideally, the packing material is large enough to rest against the back wall so as to prevent it from moving when the cabinet is pushed into position.

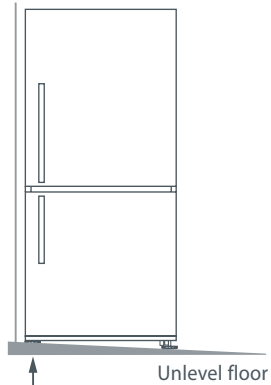

This foot lifts off the floor when top front is gently pushed back

*Example of an unstable refrigerator*

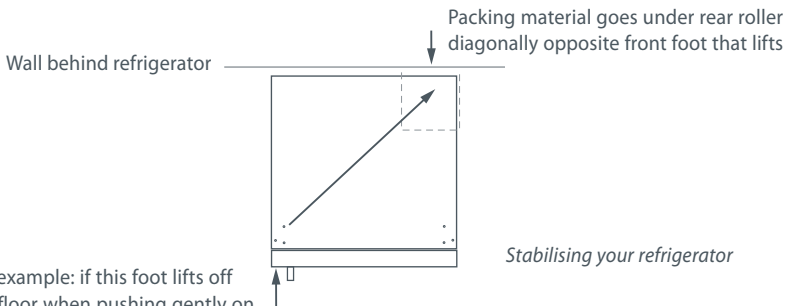

*Stabilising your refrigerator*

- C** Roll the refrigerator back into position and adjust front feet down until the refrigerator is leaning backward with the front approximately 10 mm (½") higher than the back. This will ensure a good door closing action.
- Make small adjustments to front feet where necessary.
  - Check that the product is stable (all 4 feet are on the floor). If not, repeat **A** and **B** of 'What to do if your product is unstable' section.

## Before placing food in the fresh food or freezer compartments

- Remove all internal packaging. Ensure that all transit clips are removed from the refrigerator. These are small rubber stoppers located at the back of the shelves.
- Clean the inside of the appliance with a mix of warm water and a small amount of liquid detergent, and a soft cloth to remove manufacturing and transportation dust.
- Allow the refrigerator and freezer to run empty for 2 – 3 hours to allow each compartment to cool to the appropriate temperature.
- The appliance may have an odour on its initial operation, but this will go when the refrigerator and freezer have cooled sufficiently.

## Energy efficiency

For the most energy efficient use of your appliance:

- Ensure your refrigerator has adequate ventilation as recommended in the installation instructions.
- Ensure you vacuum around the appliance to remove dust and possible pet hair accumulation. Also keep the appliance and its cabinetry free of dust by wiping down with a dry, lint-free cloth (refer to 'Cleaning care' section).
- Do not cover your appliance with any material that will prevent air from flowing around the cabinet sides.
- Allow good clearances in front of air ducts within the cabinet for maximum cold air distribution.
- Cool hot foods down before placing them in the appliance.
- Do not overfill the compartments.
- Keep door openings to a minimum.
- Select a temperature setting that isn't too cold.
- Check your door seals for leaks.

If your refrigerator is turned off for any reason, wait 10 minutes before turning it back on. This will allow the refrigeration system pressures to equalise before restarting.

## Moving your refrigerator

- Turn off the appliance and unplug from the power point. Remove all food.
- Turn the adjustable feet to the right as far as they will turn.
- Ease the refrigerator out of its position. Tuck the power cord away, tape the shelves in place and tape the doors closed. If the cabinet needs to be placed at an angle or laid down, carefully lay it on its side (the right hand side when viewed from the front).
- Relocate and install. If the appliance has been left on its side for any length of time, leave it standing upright as long as possible (as least a few hours) before turning it on.

## Storing your refrigerator

- When storing your cleaned appliance, leave the doors open. This allows air to circulate and prevents the build up of bacteria and moulds.
- Before using again, clean well using a mixture of warm water and a small amount of liquid dishwashing detergent. Rinse with clean water and dry with a soft lint-free cloth.

## Holiday time

We recommend you leave your refrigerator operating while you are on holiday.

## Soft closing door

### Soft closing refrigerator door feature (where fitted)

The fresh food compartment of your refrigerator has been fitted with a soft closing door feature. You do not need to push the door fully closed as this feature will automatically close the door from a 45° (approximate) opening angle.

### All soft close models

You may notice a little more resistance when opening the door(s) to what you are used to.

The closing speed of the door(s) decelerates at the end of closing. This is to prevent the door(s) from slamming and to ensure your food items are cared for.

#### The speed of soft closing can depend on:

- The load stored in the door shelves.
- The temperature of the fresh food compartment.
- The ambient temperature.

### French door soft close models only

The soft closing feature enables you to shut either the left or right door first.

You may notice that the closing speed of the left hand door is slightly faster than that of the right hand door. This is perfectly normal.

The freezer drawer is fitted with an additional mechanism to soft close within the last 50 mm (2").

### ***Important!***

- *Keep hands and food items clear of the door opening when the gap less than 45° (the soft close activation range).*
- *The soft closing feature is located inside the door cavity therefore it is not serviceable by the user. If a problem occurs, please contact your Fisher & Paykel Authorised Repairer.*

<b>Models:</b>	<b>635 mm wide</b>	<b>E372B, E402B, RF372B, RF402B</b>
	<b>680 mm wide</b>	<b>E442B, RF442B</b>
	<b>790 mm wide</b>	<b>E522B, RF522A, RF522W, RF522B</b>
	<b>900 mm wide</b>	<b>RF610/RF540A</b>

The control panel enables you to view and modify all the features and options on your refrigerator.

## Temperature control (all models)

- When the refrigerator is first turned on, the powerful cooling system will automatically cool both refrigerator and freezer compartments to their set temperatures. This will take between 2 – 3 hours.
- The two compartment temperatures are accurately and independently controlled and do not change with the temperature or humidity of the surroundings; whether summer or winter.
- If you wish to alter the temperature of either the fresh food compartment or freezer compartment, this can be easily done by using the internal control panel located at the front right of the refrigerator compartment.

## Internal control panel to adjust temperatures

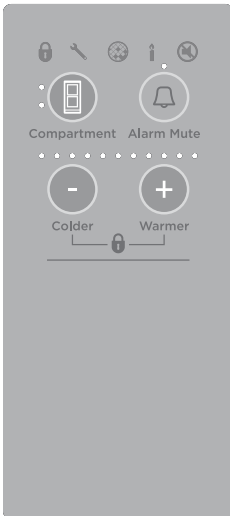

*Internal control panel for Tasman models*

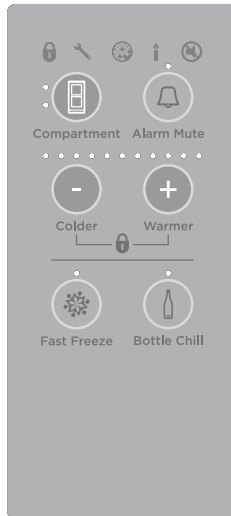

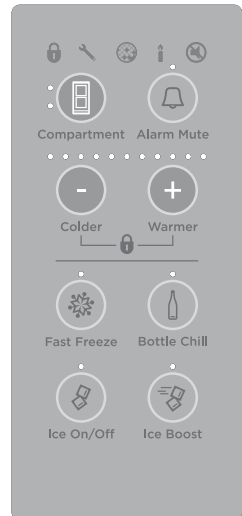

*Internal control panel for non-Ice & Water models*







*Internal control panel for Ice & Water models*

### Fresh food compartment (all models)



- The fresh food compartment light will automatically be illuminated. The temperature for this compartment will show as a series of lights.
- The temperature may be altered by pressing the  or  buttons. One press on either of these buttons will reduce or increase the number of lights by one which indicates a small change in temperature.
- Fewer lights illuminated means a cooler temperature for the compartment selected.

### Freezer food compartment (all models)

- To adjust the freezer temperature press the  button once so the freezer compartment light is illuminated.
- The freezer temperature can be altered by pressing the  or  buttons.
- One press on either of these buttons will reduce or increase the number of lights illuminated which indicates a small change in temperature.
- Fewer lights illuminated means a cooler temperature for the compartment selected.  
Note: successively pressing the  button will automatically scroll between the compartments.
- When the door is re-opened the control panel will return automatically to the fresh food compartment setting.

### Alarm Mute (all models)

For times when you require the door to be open longer than normal eg when cleaning the interior of your refrigerator press the ALARM MUTE button to silence the door alarm for 20 minutes.

- To activate, press the  button once. The ALARM MUTE light will be illuminated when the function is activated.
- ALARM MUTE will deactivate after 20 minutes and the door alarms will return to normal.
- To deactivate ALARM MUTE manually, press the  button again. When ALARM MUTE is deactivated the light is off.

Note: when the fresh food or freezer compartment door is left open for long periods of time food quality and/or safety may be compromised.





### Door alarms (all models)

- If the fresh food compartment door is left open the alarm will beep after 90 seconds and if the freezer door is left open the alarm will beep after 60 seconds.
- While either door remains open, subsequent beeps will sound every 30 seconds for 5 minutes.
- A continuous alarm will sound if either of the doors have been left open for 5 minutes or longer and the interior compartment light(s) will turn off. The alarm will stop only when the door(s) is closed.

Note: if ALARM MUTE has been activated the door alarms will be silenced for 20 minutes. After 5 minutes of the doors being left open the compartment light will turn off however the normal door alarms will be suspended. The ALARM MUTE light will be illuminated to indicate that the appliance is in this mode.







## Key Mute (all models)

KEY MUTE allows you to silence all button presses.



- To activate KEY MUTE and silence buttons, press and hold the  button for 4 seconds.
- The  icon on the internal control panel will be illuminated.
- The keys will be silenced when KEY MUTE is activated.
- Door alarms and BOTTLE CHILL alarm will still operate.
- KEY MUTE will not automatically deactivate. To manually deactivate, press and hold the  button for 4 seconds.
- The  icon will no longer be illuminated.

## Key Lock (all models)





KEY LOCK allows you to disable the buttons on the internal control panel. This is useful when cleaning your refrigerator.

- To activate KEY LOCK press and hold the  and  buttons for 4 seconds.
- The  icon on the internal control panel will be illuminated.
- Pressing any of the buttons will cause a raspberry beep to tell you that they are disabled.
- KEY LOCK will not automatically deactivate. To manually deactivate, press and hold the  and  buttons for 4 seconds.
- The  icon will no longer be illuminated.

## Sabbath mode activation (all models)

- To activate SABBATH MODE, open the door(s) of the fresh food compartment and freezer compartment and then press and hold the ,  and  buttons on the internal control panel for 4 seconds.
- The candle icon will illuminate when SABBATH MODE has been activated.







### When the product is in Sabbath mode:

- The  icon on the internal control panel will be illuminated.
- All lights on the internal control panel except for the candle icon will be off.
- The fresh food or freezer compartment lights will not operate when the door(s) is opened.
- The door alarms will not operate.
- The internal control panel will not function except to indicate SABBATH MODE is active as stated above.
- Opening the door(s) will not affect the compressor or fans.
- If the power to the refrigerator is turned off whilst in this mode, the product will continue in SABBATH MODE when the power is restored.
- SABBATH MODE will automatically de-activate 80 hours after activation.
- To de-activate earlier than 80 hours press and hold the ,  and  buttons for 4 seconds. The candle icon will no longer illuminate on the internal control panel and functionality of the internal control panel will return to normal.

## Special Functions



### Bottle Chill (selected models only)

This function allows you to chill your beverages more rapidly in the freezer without the worry of forgetting about them. The timer is set for 15 minutes however the time taken to chill depends on the size of your beverage. If after 15 minutes your beverage is not cold enough, simply place it back in the freezer and reset the BOTTLE CHILL function.

- To activate, press the  button on the internal control panel. The BOTTLE CHILL light will be illuminated when the function is activated. The  icon will be illuminated on the external display (Ice & Water models only).
- An alarm will sound after the 15 minute time has elapsed.  
**For non-Ice & Water models:** open the fresh food compartment door and press the  button on the internal control panel to silence the alarm.  
**For Ice & Water models:** the  icon will flash on the external display. Press the  button on the external display to silence the alarm.
- Remember to remove your beverage from the freezer.
- To deactivate BOTTLE CHILL before 15 minutes has elapsed, press the  button again. When the function is deactivated the BOTTLE CHILL light is off on the internal control panel and the  icon is not visible on the external display (Ice & Water models only).

### Fast Freeze (selected models only)





We have created the FAST FREEZE feature to help you get the best possible results when freezing fresh food. FAST FREEZE boosts the freezing speed by dropping the freezer to its coldest temperature for 12 hours, which helps to ensure vital freshness, texture and taste are retained during the freezing process.

- To activate, press the  button on the internal control panel. The FAST FREEZE light will be illuminated when the function is activated.
- To deactivate before the 12 hours has elapsed, press the  button again. When FAST FREEZE is deactivated the light is off.
- For best results we recommend that you activate the function before it is required. Alternatively, activate it when placing food into the freezer.

### Ice boost function (Ice & Water models only)

This function is designed to be used for times when you require more ice eg when you are having a party. The ICE BOOST function will increase ice production up to 30%\* from standard ice making and deactivate automatically after 24 hours.



\*Dependent on your current temperature settings.

- When you first turn your ice maker on, the ICE BOOST function will be off.
- To turn this function on, press the  button. The light above the  button will be illuminated when the ICE BOOST function is on.
- The ICE BOOST function is paused once your ice bin is full.
- To manually deactivate this feature press the  button again. The light above the  button will be off when the ICE BOOST function is off.
- Activating the ICE BOOST function will automatically turn ice making on.
- Deactivating ice making will automatically deactivate the ICE BOOST function.

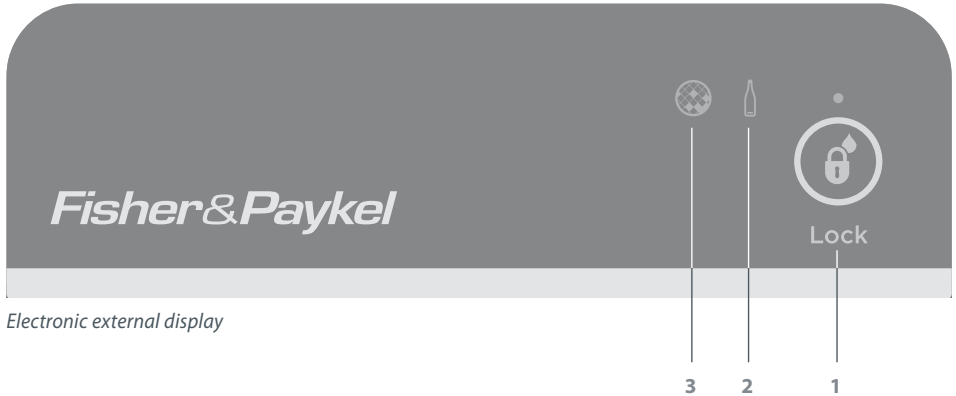
This screen enables you to lock the water dispenser, indicates to you when BOTTLE CHILL is activated and when your water filter requires changing.



## Keys

 Lock	<b>1. Dispenser lock button and light</b> Locks/unlocks the water dispenser. Light is on when the water dispenser is locked.
	<b>2. Bottle Chill indicator</b> Indicates when BOTTLE CHILL is on and flashes when beverage is ready.
	<b>3. Filter change indicator</b> Indicates when the water filter requires changing.

Note: icons will be visible only when the functions are active.

## Using your water dispenser (Ice & Water models)

Ensure your ice and water system has been correctly installed by following the 'Installation instructions' section before using your water dispenser.

### Dispensing

- Your water dispenser has been designed for one-handed operation.
- To dispense water push the dispensing pad gently, using a glass or container. This pad requires only a gentle press to activate.
- To stop the flow of water, simply pull your glass away from the dispensing pad.



Water dispenser

Please remember that pressing very hard against the dispensing pad will not encourage the dispenser to operate faster or produce greater quantities of water.



### **Important!**

*To avoid damage to property or personal injury do not put hands, fingers or objects up the dispenser opening.*

Please note that once installation is complete a few drips may appear out of the dispenser over the next few days as the remaining trapped air is cleared.

### Dispenser Lock

The DISPENSER LOCK prevents water from being dispensed. This is useful when you are cleaning the external display or when there are small children around.

- Press and hold the  button for 4 seconds to activate DISPENSER LOCK.
- The light above the DISPENSER LOCK icon will be illuminated.
- Pressing the water dispenser pad will cause a raspberry sound indicating to the user that water cannot be dispensed.
- To de-activate the DISPENSER LOCK, press and hold the  button for 4 seconds. The light above the DISPENSER LOCK icon will no longer be illuminated and water dispensing will be enabled.

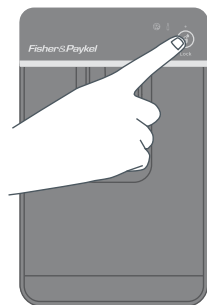

Dispenser Lock

All the water to your refrigerator is filtered to remove impurities through a filter cartridge located in a position of your choice outside the refrigerator. This will need changing approximately every 6 months.

- There is a filter change icon  on the internal control panel and external display which will appear when the filter needs replacing. It will flash, as a reminder, when water is dispensed.
- Replacement filter cartridges are available through Customer Care or online at [www.fisherpaykel.com](http://www.fisherpaykel.com) (this service is available to selected markets only). The details of the replacement filter cartridge are on the label of the cartridge. Alternatively filter cartridges can be purchased from your Fisher & Paykel Authorised Repairer.

## Changing the water filter cartridge

It is not necessary to turn off the water supply before attempting to change the water filter cartridge.



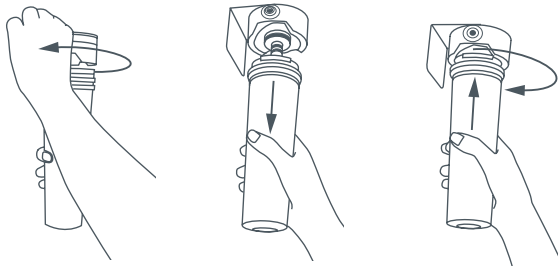

- 1 Grasp and firmly twist the cartridge in an anticlockwise direction (to the left when installed in the recommended orientation).
- 2 Pull the cartridge away from the filter head (down when installed in the recommended orientation). It is not unusual for a few drops of water to be present when the filter is removed.
- 3 Discard the old filter.
- 4 Filter installation:
  - Remove protective cap on spigot on head.
  - Push the cartridge up towards filter head while rotating it in a clockwise direction (to the right when installed in the recommended orientation).
- 5 Reset filter indicator icon on the display (this will remind you when the filter is due to be replaced again).
- 6 To flush the water filter of any trapped air, harmless carbon fines and to also check for leaks, disconnect the tubing from the back of the refrigerator, aim the end of the tubing into a bucket, turn isolating tap on and run at least 10 litres (10 qt) of water through. Once complete turn isolating tap off. Reconnect the tubing.
- 7 A few drips may appear out of the dispenser over the next few days as the remaining trapped air is cleared.



*Changing the water filter cartridge*



## To reset the filter change icon

### **Important!**

- *We recommend the water filter be used from the time of installation, and the change filter icon be reset only when a replacement is installed.*
- *Do not reset the change filter icon before the filter is changed or the filter monitoring will be inaccurate.*
- *We recommend the water filter cartridge is replaced when the internal and external  icons illuminate. This will happen every 6 months.*
- Press and hold  and  buttons for 4 seconds on the internal control panel.
- The filter icon  on the internal and external displays will turn off when reset.

## To disable the filter change icon

If the change filter icon is disabled you will not be reminded of when to next change your filter cartridge. We only recommend disabling this function when no filter cartridge is fitted.

- Press and hold   and  button for 4 seconds to turn this feature off.
- We recommend that you do not disable the filter indicator if you have a filter fitted to the connection.





### **Important!**

- *To avoid serious illness or death, do not use the water filter where water is unsafe or of unknown quality.*
- *The water filter cartridge needs to be changed when the filter indicator icon flashes on the interface panel.*
- *If the water filtration system has been allowed to freeze, replace filter cartridge.*
- *The rate of water flow through the water dispenser can slow down as the filter cartridge accumulates any sediment which may be present in the water supplied to your home. This varies depending upon your local water quality, which may require your filter cartridge to be changed more frequently.*
- *In cases of excessively reduced filter life we recommend that you consult a local plumber or your water supplier for advice on suitable filtration requirements for the water supplied to your home.*
- *Filter replacement is the consumer's responsibility and will not be covered by the Manufacturer's Warranty except in the case of faulty parts or materials within the filter cartridge.*
- *If the water has not been dispensed for some time or water has an unpleasant taste or odour, flush system by dispensing 4 litres (4 qt) of water.*
- *If unpleasant taste or odour persists, you may wish to fit a new filter cartridge.*

## Ice On/Off

Your automatic ice maker is designed to dispense ice cubes into the ice storage bin below until it senses the bin is full. If you require more ice, the storage bin can be removed and ice will dispense into the top freezer bin.

### Before you start using you automatic ice maker

- When you first turn your refrigerator on after installation, the ice maker will be off.
- To turn your ice maker on press the  button. The light above the ICE ON/OFF icon will be illuminated when the ice maker is on.
- Press and hold ,  and  buttons together for 4 seconds then close the door(s). The ice tray will flip twice and empty the water into the bin below. The ice tray will flip only after the doors are closed.
- Force another cycle, this step helps remove any manufacturing and transportation dust in the ice tray.
- Empty the water and correctly replace the bin, ensuring the scoop is located at the front of the bin.
- If the bin is full of ice, inserted incorrectly or if all bins are removed, the ice maker will not operate. When the bin is inserted correctly the scoop will be on the right hand side of the bin or at the front of the bin.
- Once your ice maker is in operation, discard the first 3 harvests of ice (8 ice cubes are produced per harvest). This will flush away any impurities in the water line and ensure that you get the best quality ice. We recommend that you also do this after vacations or extended periods of not using ice.
- We recommend that you turn the ice maker off if:
  - The water supply is to be off for several hours, or
  - The ice storage bin is to be removed for a period of time, or
  - You are going on holiday/vacation.



*Turning ice maker on*

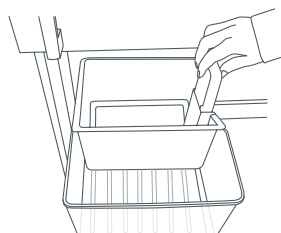

E402B, E442B, E522B,  
RF402B, RF442B, RF522A,  
RF522W and RF522B

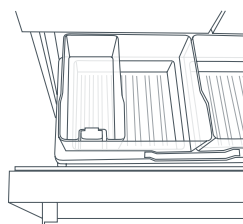

RF610A/RF540A

*Ice storage bin and  
scoop in correct position*

## Information about your automatic ice maker

- Your Ice & Water product comes with a ice storage bin located inside the top freezer bin, and a hygienic scoop for ice. This scoop provides hygienic access to clean, clear ice cubes.
- Your automatic ice maker will produce approximately eight cubes of ice every 3 – 4 hours, depending on the freezer compartment temperature and the number of door openings.
- The ice cube tray will fill with filtered water.
- When cubes are frozen, they will be dispensed from the ice tray and into the ice storage bin below.
- Ice making will continue until the storage bin is full, and only resume once you start to use the stored ice.
- When the 'Ice Boost' function is activated, ice production will increase up to 30%\* from standard ice making. This function automatically deactivates after 24 hours.

\*Dependent on your current temperature settings.

- If large amounts of ice are required, remove an ice storage bin and allow ice to fill the top freezer bin.
- For maximum ice storage, level the stored cubes with the ice scoop.
- If ice is not used often, old cubes will become cloudy, taste stale, will shrink and may stick together. Empty the ice storage bin periodically and wash in lukewarm water. Dry thoroughly and place back into the correct position.

## ***Important!***

- *Avoid contact with the moving parts of the ice maker ejector mechanism, and do not place your fingers on the automatic ice making mechanism while the refrigerator is in operation.*
- *Do not use ice cubes that may have become discoloured, usually with a green-blue colour. If such discolouration is noted, discard the ice cubes and contact your Fisher & Paykel Authorised Repairer.*
- *Ensure the ice maker is connected to the filter and to a drinkable water supply only.*
- *Installation of the water connection to the ice maker must be completed by a qualified service technician or a qualified plumber (see installation instructions).*

## Manual ice system (RF522W, RF522A and RF522B models)

An ice storage bin which sits inside the upper top freezer bin provides storage for and gives you access to clean, clear ice cubes.

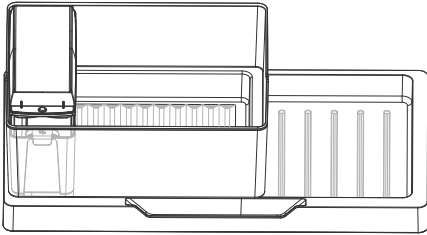

*Upper left freezer bin, ice storage bin, ice tray, lid and scoop in correct position*

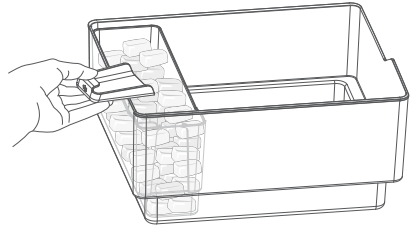

*Accessing your ice*

## Information about your manual ice system

- To make ice, take the ice tray and lid from on top of the ice storage bin. Remove the lid from the ice tray and fill the tray with water. Place the lid back on the ice tray and carefully position it back onto the ice storage bin.
- Once the ice is solid, take the ice tray and lid off the ice storage bin, remove the lid from the tray and twist the ice tray at each end in opposite directions. Turn the ice tray over the ice storage bin to dislodge the cubes into the bin.
- Fill the ice tray with clean water and repeat to fill the ice storage bin.
  
- Attached to the ice storage bin is the ice scoop which provides hygienic access to ice.
- To access ice cubes, take the ice tray and lid from the top of the ice storage bin and place onto a flat surface. Take the scoop from the front of the bin, scoop cubes into vessel and then replace the scoop, tray and lid back to the top of the bin.
- For maximum ice storage, level the stored cubes around the bin with the ice scoop.
- If ice is not used often, old cubes will become cloudy, taste stale, will shrink and may stick together. Empty the ice storage bin periodically and wash in lukewarm water. Dry thoroughly and place back in the correct position.

## Ice trays and lid

- To make ice, remove the lid from the ice tray and fill the tray with water. Place the lid back on the ice tray and carefully position it on a flat surface in the freezer compartment.
- To empty the ice cubes into the lid, hold the tray and lid together and twist the ends of the tray in opposite directions to dislodge.
- Refill the ice tray with water and store in the freezer.
- Ice cubes are best stored in a closed container or plastic bag as they readily absorb odours and tastes from other foods.

### Fruit and vegetable bins and humidity control lid

- The unique humidity control lid functions to seal the bins and provide a humid microclimate to extend the storage times of fruit and vegetables.
- During times of high humidity the lid also functions to prevent condensation from dripping onto the fruit and vegetable by retaining this moisture in the lid's specially designed grooves.

### Fruit and vegetable bins and humidity slide

- Each fruit and vegetable bin has an adjustable humidity slide which enables you to choose a fruit or vegetable setting depending on your storage needs.
- If there is too much water in the bins (due to high humidity), the control can be adjusted towards the setting with fewer drips (fruit setting, 🍊) and/or the water can be wiped dry when required.
- Remember a small amount of water in the bins is beneficial for fruit and vegetable storage.
- When storing vegetables; which are ethylene sensitive produce such as lettuce, spinach, broccoli, cabbage, carrots. We recommend using the vegetable setting, 🥬.
- When storing fruits which are generally high ethylene producers; such as citrus fruits, stone fruits and some tropical fruits. We recommend using the fruit setting, 🍊.
- When storing a combination of fruit and vegetable, we recommend adjusting the humidity slide to the centre.
- Ideally store whole fruits and vegetables without external packaging, if possible, and in separate bins. Separating fruit and vegetables will prevent ethylene-sensitive produce from ripening too quickly, and help extend their storage life.

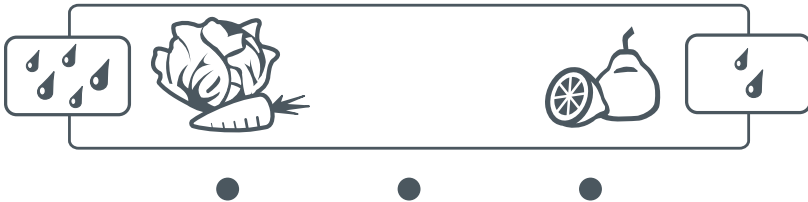

*Humidity control graphic*

### Slim storage drawer (where fitted)

The slim bins at the bottom of the fresh food compartment provide storage space for items that you may want to keep separate from the rest of the refrigerator. These slim storage bins can be used for deli item storage, beverages or for defrosting foods.

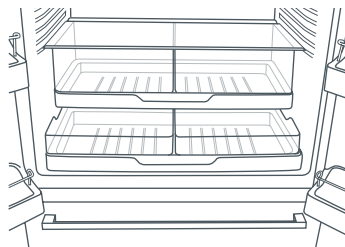

*Slim storage drawer*

### Bottle holder (where fitted)

- The bottle holders can be used to store a variety of bottles.
- To position the bottle holder in your refrigerator, simply slot the back edge of the bottle holder onto the back trim of any shelf in the fresh food compartment.
- If you are not using all or some of the bottle holders, the unused bottle holders can be stacked up on top of one another so they do not take up unnecessary shelf space.
- Bottles are best stored with the neck of the beverage facing the front of the refrigerator.
- Additional bottle holders are available through Customer Care or online at [www.fisherpaykel.com](http://www.fisherpaykel.com) (this service is available to selected markets only).

### Glass shelves

- Glass shelves can be repositioned in the cabinet as desired.
- Remove shelves by lifting up the back of the shelf and then pulling the shelf forward.

### Drip tray (Ice & Water models only)

- The drip tray is designed to fit into the bottom of the water dispenser panel.
- To insert the tray always ensure that the rounded sides are fitted into the dispenser panel first.
- The purpose of the tray is to capture any odd drips of water that may fall after dispensing.
- The tray can be easily removed for cleaning.

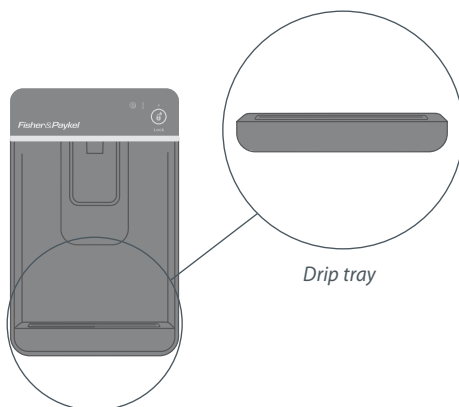

## Exterior (all models)

### Stainless exterior doors

- It is important when cleaning the exterior door surface of your refrigerator, to only use liquid dishwashing detergent dissolved in warm water and a soft cloth.
- Dry the door with a clean, lint free cloth.
- The use of any abrasive or stainless steel cleaners and solvents will damage the door surface.



### Other exterior surfaces (all models)

- Clean all other exterior surfaces with a mix of warm water and liquid dishwashing detergent, and a soft cloth.
- If necessary, clean the magnetic door gasket and the centre door gaskets with an old toothbrush, warm water and liquid dishwashing detergent.

### Rear compartment cover (model dependent)

- To maximize operating efficiency regularly vacuum the flooring around your appliance.
- Cleaning behind the appliance is required once or twice a year. More frequent cleaning may be necessary for dusty homes or those with pets shedding hair.
- To do this wind up the feet and carefully ease the refrigerator out of its position. Switch off and unplug.
- Vacuum the flooring behind your appliance and around the rear compartment cover to remove dust accumulation. Use a dry lint-free cloth to clean the appliance walls and surrounding cabinetry.
- After cleaning, plug in and switch on. Push the appliance into position and wind feet down.

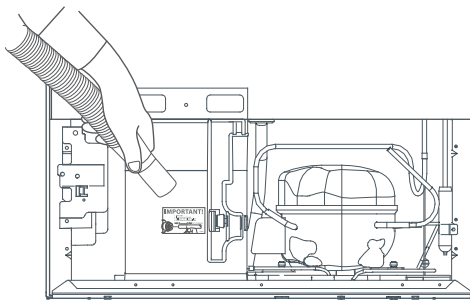

*Cleaning your rear compartment cover*

## Water dispenser pad and interface (Ice & Water models only)

- We have incorporated a Dispenser and KEY LOCK function in your refrigerator to make cleaning easier. This will help you to avoid accidental water dispensing while you clean.
- Clean the pad and interface panel with a microfibre cloth and a mixture of warm water and liquid dishwashing detergent.

## Drip tray (Ice & Water models only)

- To clean, take the tray out of the dispenser panel and pull the two halves of the tray apart.
- Clean in warm water with a mild detergent. Dry the tray and clip back together.
- Reinsert the tray back into the dispenser panel.

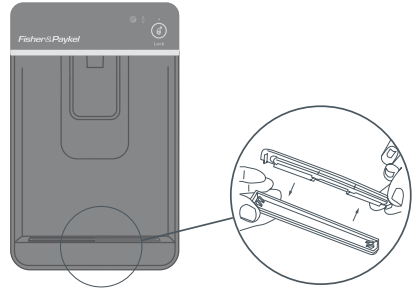

*Cleaning the drip tray*

## Interior (all models)

- It is important to keep the interior of the refrigerator and freezer clean to help prevent food from becoming contaminated during storage.
- The amount and types of food stored determines how often cleaning should be carried out in the refrigerator (ideally once every 1 to 2 weeks).
- Remove the shelves from cabinet and door. Wash shelves and storage bins in warm water and detergent; rinse in clean water and dry before replacing.
- Wipe over the interior surfaces with warm water and liquid dishwashing detergent. Alternatively you can use 1 tsp baking soda dissolved in 500 ml (½ qt) of warm water. Rinse with clean water.
- To help remove “old stale refrigerator” smells add a few drops of vanilla essence or vinegar to the water before cleaning.
- Clean interior surfaces with warm water and liquid dishwashing detergent. Use a toothbrush for the magnetic door gasket.
- Do not use harsh, abrasive cloths on any part of the refrigerator or freezer.

## Glass shelves (all models)

Clean with warm water and detergent or a glass cleaner.

## Bottle holder (where fitted)

Clean with warm water and detergent. The use of abrasive cleaners and solvents may cause damage.

## Automatic ice maker (Ice & Water models)

- We do not recommend you cleaning the ice maker components, but it is important to regularly clean your ice bin and discard any old ice in the bottom of the bin(s).
- When going on vacation/holiday we recommend you turn the ice maker OFF on the internal control panel and shut off the water supply to the refrigerator (if accessible). Refer to ‘Using your ice maker’ section.
- On your return turn on the water supply to the refrigerator (if accessible). Flush the water filtration system by dispensing 4 litres (4 qt) of water and discarding. This will ensure the tank is refilled with fresh water.
- Turn on the ice maker and discard the first 3 harvests of ice (8 ice cubes are produced per harvest). Refer to ‘Using your ice maker’ section.

## Humidity Control System

### **Important!**

*When cleaning the shelf above the vegetable bins, we recommend that you do not disassemble the Humidity Control System from the shelf.*

In the event that the humidity control lid (plastic lid) and humidity slides become separated from the glass shelf, follow these instructions to reassemble.

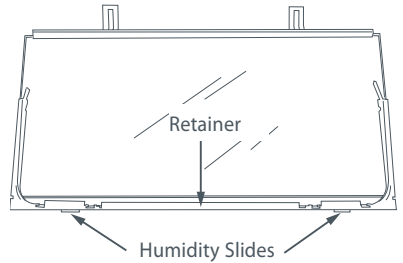

- 1 Turn shelf upside down
- 2 To attach humidity slides onto shelf front corners, fit bottom clips into shelf front trim. Next, slide sideways towards shelf until arm clips onto glass.

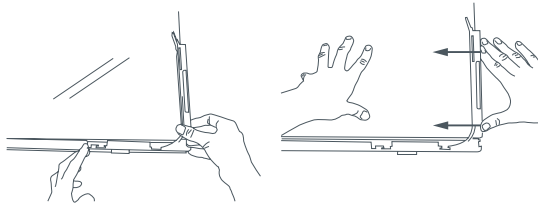

- 3 To attach humidity control lid – with text facing you, align lid with front of shelf. Hold lid vertically and fit front end into retainer on shelf. Ensure lid fits into retainer as well as underneath humidity slides.

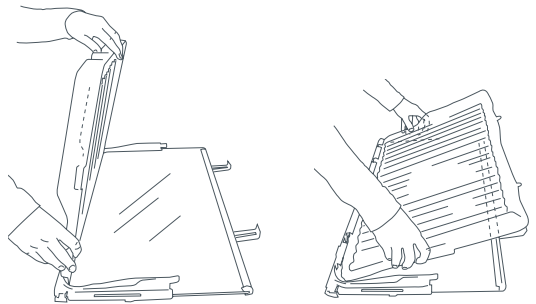

- 4 At the sides of the shelf, adjust humidity slide tabs so that the plastic lid is between the shelf and the tabs.
- 5 If clips on back of shelf are present, fasten lid with rear clips. Ensure that the cover is fully secure at front and back of shelf.

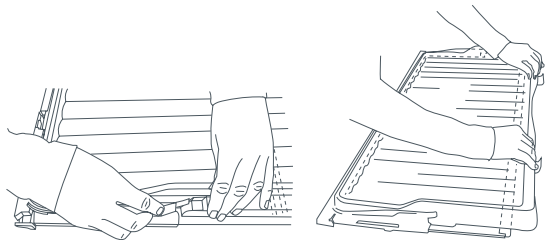

*Humidity Control System cleaning*

### To remove produce bins or upper freezer bins

- To remove bins, roll out the tray and then use two hands when picking up a bin. Picking up a bin one-handed may cause it to crack or break.
- Remove the bins, wash and replace back onto trays.

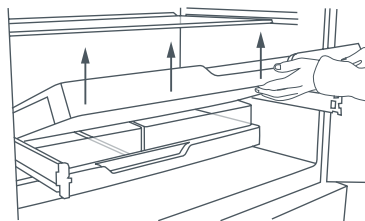

Tray removal

### To remove trays

- For ease of removal, empty food from tray/remove the bins from the tray first.
- Hold the centre front of the tray handle.
- Lift vertically to unclip from the runners and pull tray towards you to remove.
- Push both runners back into refrigerator.

### To replace trays

- With the runners pushed back into the refrigerator, place the tray on top of the runners. Push the tray back slowly until you feel it clip back onto the runners.

## **Important!**

- *Ensure that trays are securely clipped onto the runners before use.*
- *Tray runners are pre-lubricated, and will not need to be re-lubricated during their life. Do not attempt to clean grease from the runners, as this will affect their ability to function. Do not immerse runners in water.*

### Permanently fixed bins and trays (Freezer drawer models only)

The freezer bins and trays in this model are permanently fixed. They cannot be removed from the freezer compartment. To clean simply wipe with a soft, damp cloth.

### Ice storage bin

#### All models

- When going on vacation/holiday we recommend cleaning your ice bin and discarding any old ice in the bottom of the bin(s) before leaving.
- When cleaning use only liquid dishwashing detergent dissolved in warm water and a soft lint-free cloth. Rinse with clean water and dry with a clean, lint-free cloth.
- When replacing the bin ensure that the ice scoop is positioned at the front.

Your refrigerator is designed to help prolong the storage life of fresh and cooked foods. Each compartment's specialised zones along with a constant cold temperature delays the onset of food spoilage – particularly the metabolic growth of bacteria, moulds and yeasts causing chemical and physical changes.

## General fresh food care

The quality of food before being placed in the refrigerator is critical to successful storage. This determines how long foods stay fresh for, and how long they can be kept refrigerated.

### For best results:

- Only select foods of high quality and freshness.
- Only purchase foods you plan to use within the recommended storage time. If extra is purchased, plan to freeze the foods.
- Before storing foods, ensure they are wrapped in suitable packing material.
  - This will prevent food from dehydrating, deteriorating in colour or losing flavour and will help maintain freshness. It will also prevent odour transfer.
  - Fruit and vegetables do not require wrapping and are recommended to be stored in the vegetable bins of the refrigerator.
- Ensure perishable foods are stored in the refrigerator immediately after purchase; this will prolong their shelf life. Storing at room temperature increases the rate of deterioration.
- Avoid placing food directly in front of air outlets; this may freeze foods and decrease the efficiency of cold air in the refrigerator to maintain safe food storage.
- Keep door openings to a minimum and do not open unnecessarily.
- Ensure hot foods and drinks are cooled sufficiently before placing them in the refrigerator. Hot foods may cause other foods to warm to unsafe temperatures. If in contact with plastic components of your refrigerator, hot containers may cause damage. Additionally hot foods may cause an increase in energy consumption.
- Ensure raw and cooked foods are stored in separate air tight containers to prevent cross contamination. We recommend storing raw foods on the bottom shelf of the refrigerator.
- Keep the refrigerator clean by frequently wiping the inside walls and shelves (refer to 'Cleaning care' section).
- Pay attention to the quality of foods in your refrigerator.
  - Discard foods that show signs of spoilage (by visual inspection and odour).
  - Pay particular attention to protein rich foods (meats, fish and poultry) as some deteriorate faster than others.
  - Use foods within the recommended storage dates.

### Dairy foods and eggs

- We recommend high-in-fat dairy products eg butter, cheeses are stored in the covered door shelves of the refrigerator as these foods are easily tainted by strong odorous foods.
- We recommend eggs stored in the covered door shelves of the refrigerator or in their carton as the porous egg structure is susceptible to absorbing odours.
  - When using eggs in baked goods it is ideal to use room temperature eggs. Be sure to remove the required eggs 2 hours beforehand.
- Ensure pre-packed dairy products stamped with recommended 'use by/best before/best by' dates are consumed within the recommended storage time.
- Ensure dairy products are stored in their original packaging until ready to consume. Once opened, package any remaining in suitable packing material eg cling film to avoid the transfer of odours.

## Storing food in your refrigerator

### Precooked foods and leftovers

- Ensure cooked foods are stored in suitable covered containers, this will prevent foods from drying out.
- Keep for only 1 – 2 days.
- Reheat leftovers only once and until steaming hot.

### Red meats

- Ensure raw and cooked foods are stored in separate air tight containers to prevent cross contamination from the loss of raw meat juices.
- Ensure delicatessen meats are consumed within the recommended storage time. These can be stored in the slim storage bin if you want to keep separate.

### Poultry

- Keep whole poultry or poultry pieces in the original packaging until just before use.
- We recommend placing the packaged poultry in a dish and storing on the bottom shelf of your refrigerator to prevent any potential spills from contaminating other foods.
  - Whole poultry or poultry pieces should only be stuffed right before cooking. Preparation in advance may result in food poisoning.
- Ensure stuffing is removed from cooked poultry, and both are sufficiently cooled then covered before storing in the refrigerator.

### Fish and seafood

- Whole fish and fillets are ideally consumed on the day of purchase. Ensure they are stored in suitable covered containers or packaging, this will prevent foods from drying out and transferring odours.
- If storing overnight or longer, ensure whole fish is cleaned and dried before covering and storing, preferably on a bed of ice, in your refrigerator.
- Ensure fish fillets and other seafood are treated the same way.
- Keep shellfish chilled at all times and consume within 1 – 2 days.

### Fruit and vegetables

- Not all fruit and vegetables are suitable for prolonged refrigeration storage at temperatures below 5°C (41°F).
  - Undesirable physical and chemical changes will result from low temperature storage, such as loss of rigidity, browning, increased rate of deterioration and potential loss of flavour.
- Try to store fruit and vegetables separately, as each emit different ethylene levels – the cause of ripening.
- Ensure fruits are not washed before storage, this increases the rate of deterioration.
- Ensure vegetables are sorted and damaged parts are discarded.

### Beverages

- Ensure beverages are stored tightly on the door shelves of the refrigerator. This prevents the bottles from tipping or falling out when the refrigerator door is opened. Otherwise use bottle holders to store beverages on the shelves.
- The door shelves are held by support lugs and are fully adjustable to suit your storage requirements.

Freezing and storing foods at temperatures  $-18^{\circ}\text{C}$  ( $-0.4^{\circ}\text{F}$ ) or colder helps retain the physical quality and nutritional value of foods. Low temperatures inhibit the growth of bacteria, moulds and yeasts, thereby restricting chemical and physical reactions to extend the food's storage life.

## General fresh frozen food care

Successful freezing depend on the foods' quality, packaging and proportions. We recommend freezing foods fast to maintain moisture content and to prevent the formation of large ice crystals.

### For best results:

- Only select foods of high quality and freshness.
- Ensure foods are packaged in suitable packaging material before freezing.
- Ensure foods freeze as quickly as possible and in small quantities. Do not attempt to freeze more than 1 kg of meat per 25 litres (26 qt) of freezer storage volume.
  - Freezing in smaller quantities helps retain the nutrient qualities and appearance of the food as best as possible.
- When freezing many foods at once, we recommended activating the 'Fast Freeze' function 2 hours beforehand.
  - Ensure fresh food to be frozen does not come into contact with already frozen foods. This will cause frozen foods to start defrosting.
- When freezing foods containing liquids or semi-solids ensure there is a 20 – 50 mm ( $1\frac{3}{16}$  – 2") head space to allow the foods to expand as they freeze.
- Keep door openings to a minimum and do not open unnecessarily.
- Ensure all air is removed from food packaging. This will avoid large formation of ice crystals and prevent freezer-burn on foods. The formation of small ice crystals is normal.
- Ensure hot foods and drinks are not placed directly into the freezer. Hot containers may damage shelves and walls of the refrigerator, increase energy consumption and cause already frozen foods to defrost.
- Ensure there is a constant turnover of foods. Use older items of food first and do not exceed the recommended storage times. See table below.
- Ensure partially or fully defrosted foods are never re-frozen. Defrosted foods can only be refrozen after it has been cooked.

## Recommended freezer storage times for freshly frozen foods

These times should not be exceeded.

Months	Type of food stored
1	Bacon, casseroles, milk
2	Bread, ice cream, sausages, pies, prepared shellfish, oily fish
3	Non-oily fish, shellfish, pizza, scones and muffins
4	Ham, baked goods, beef and lamb chops, poultry pieces
6	Butter, blanched vegetables, whole eggs and yolks, cooked crayfish, raw minced meats
12	Dried fruits or fruit in syrups, egg whites, raw beet, whole chicken, raw lamb, fruit cakes

## Storing food in your freezer

### Precooked foods and leftovers

- Ensure cooked food are stored in suitable covered containers and away from raw frozen foods.
- Not all foods are suitable for freezing; some separate on defrosting such as cooked egg whites, custards and cream fillings, meringue toppings, milk porridges, gelatine or jelly-like dishes and salad dressings.

### Red meats, poultry and game

- We recommend selecting lean meats as opposed to fatty meats. These have a lower fat content, freeze much better and can be stored longer.
  - When packaging meats (chops, steaks, cutlets) separate with sheets of plastic freezer film, then package all together. This prevents the meats forming into a solid block on freezing.
- Ensure stuffing is removed from poultry prior to freezing. Whole poultry or poultry pieces should only be stuffed right before cooking. Preparation in advance may result in food poisoning.

### Fish and seafood

- Ensure whole fish are rinsed inside and out with cold running water to remove loose scales and dirt, then dried and packaged before storing in the freezer.
  - Seal the whole fish or fillets well to prevent transfer of odours and flavours to other foods.

### Fruit

- Choose high quality, mature, and ready to eat fruits. Only select fruit varieties recommended for freezing.
- Avoid purchasing unripe or over-ripe fruits.
- Most packaged fruits can be stored for 8 – 12 months.
  - Fruits packed in syrup are ideal for desserts, while fruits packed without sugar are better used for cooking.

### Vegetables

- Not all vegetables are suitable for freezing eg lettuce, radishes, and onions. Only select mature and ready-to-eat vegetables recommended for freezing.
- Ensure vegetables are sorted and damaged parts are discarded.
- We recommend blanching vegetables before freezing. This technique inhibits vegetable enzymes and helps preserve the colour, flavour and nutritional value of the vegetables without chemical or physical damages.
  - To blanch, boil vegetables in boiling water for 2 – 4 minutes, remove and cool quickly in ice-cold water. Drain well then package.
  - Do not season blanched vegetables before freezing, only lightly season after cooking. If seasoned beforehand the flavour can intensify on freezing more than what is expected.

### Beverages

- We recommended cooling carbonated beverages only when the 'Bottle Chill' function is active.
- Do not store carbonated drinks without this function in the freezer, failure to remove beverages could lead to freezing liquid and the likelihood of bottle/can explosion.

### Ice cubes (for non-Ice & Water models)

- Ensure ice trays are only filled  $\frac{3}{4}$  of the way. This allows enough room for water to expand on freezing.
  - Leftover gravy can be made into gravy cubes for next cooking use. To make, fill ice trays  $\frac{3}{4}$  of the way with is sufficiently cooled gravy mixture then freeze.

Your refrigerator is also designed to help defrost/thaw foods in a safe manner by avoiding the growth of bacteria, moulds and yeasts – major causes of food spoilage.

## General defrosting food care

### For best results:

- Ensure foods are defrosted in the refrigerator, microwave oven or multifunction oven.
  - Never defrost foods at room temperature, this could potentially promote the growth of bacteria and cause food poisoning even after cooking.
  - Foods can be defrosted in the slim storage drawer (where fitted) if you want to keep separate from the rest of the refrigerator.
- Ensure partially or fully defrosted foods are never re-frozen. Defrosted foods can only be refrozen after it has been cooked.

### Red meats, poultry and game

- Red meat can be cooked from frozen, or from the partly or completely defrosted states. Ensure extra cooking time is given when cooking from the frozen state.
- Ensure poultry is completely defrosted before cooking and never use the frozen juices for cooking. We recommend washing your hands thoroughly to avoid the chances of food poisoning, especially salmonella poisoning.

### Fish and seafood

- Ensure fish does not come into contact with other foods when defrosting in the refrigerator.
- For best results, cook from either the frozen or partly defrosted state.

### Fruit and vegetables

- Defrost frozen fruits in the refrigerator. Alternatively they can be used as part of frozen desserts.
- Frozen vegetables are best cooked from their frozen state.

## Recommended refrigerator packaging materials

Do use	Don't use
Polyethylene film/cling film/plastic food wrap	Wrapping paper/cellophane
Heavy-duty aluminium foil	Grease-proof/cooking paper
Air-tight containers with lids	Permeable wraps
Plastic freezer film	Plastic carrier bags
Freezer bags	Rubbish bags

## User warnings

### Faults

In the unlikely event a fault occurs the  icon will illuminate on the internal control panel and an alarm will sound when the fresh food compartment door is opened.

- Please count the number of beeps made when the fresh food compartment door is opened. Please also take note of the number and sequence of temperature lights displayed on the internal control panel and contact our Customer Care Centre.
- To silence the fault alarm press any button on the internal control panel. The  icon will remain illuminated until the fault is corrected.

## Normal refrigerator sounds



*ActiveSmart™* refrigerators, with their excellent energy ratings and cooling performance, can produce sounds somewhat different to your old refrigerator.

### Normal operational sounds include:

- Fan air flow sound. *ActiveSmart™* refrigerators have fans which change speed depending on demand. During cooling periods, such as after frequent door openings, fans circulate the cold air in the refrigerator and freezer compartments producing some air flow sound. This is quite normal.
- Cracking or popping sounds. This may occur when the automatic defrost function is operating.
- Running water sound. This is the liquid refrigerant in the system and can be heard as a boiling or gurgling noise.
- An audible hissing sound after closing the freezer door. This is due to the pressure difference between the warm air that has entered the cabinet and suddenly cooled, and the outside air pressure.
- Humming sounds. This is the compressor running and is quite normal.
- Gasket noises which can normally occur over time due to a build up of dirt and/or grime. See 'Cleaning Care – Exterior' section.
- Ice maker and water dispenser sounds:
  - Motor operation (low humming).
  - Running water as the ice maker and/or water tank fills.
  - Water valve opening and closing (hissing sound).
  - Ice being loosened from the ice moulding tray (cracking).
  - Ice dropping into bin (clunking).
- Other sounds may be heard for the following reasons:
  - Cabinet not level
  - Floor uneven or weak
  - Bottles or jars rattling on shelves

If there is a problem with your appliance, please check the following points before contacting your local Fisher & Paykel Authorised Repairer or the Customer Care Centre.



Product parts and accessories can be purchased through Fisher & Paykel Customer Care Centre or online at [www.fisherpaykel.com](http://www.fisherpaykel.com) (this service is available to selected markets only).

All models		
Problem	Possible causes	What to do
<b>Appliance does not operate.</b>	No electricity at power outlet.	Check that the plug is correctly connected and power switched on. Check another appliance at the same outlet. Check house fuse.
<b>Light not working.</b>	Light not functioning.	The LED light cannot be serviced by the user. Contact your Fisher & Paykel Dealer or Fisher & Paykel Authorised Repairer.
	Refrigerator not working.	Check refrigerator is turned on at wall.
<b>Light and display not working.</b>	Product in SABBATH MODE.	Press and hold  ,  and  buttons together for 4 seconds.
<b>Motor operates for long periods.</b>	Hot weather. Frequent door openings. Large amount of food recently added.	Minimise door openings to allow temperature to stabilise.
	Temperature control set too low.	See 'Operating instructions' section.
	Doors not sealing properly.	Check that cabinet is level and gasket seals are clean. See 'Cleaning Care – Exterior' section.
<b>Storage compartments too warm.</b>	Temperature setting not correct.	See 'Operating instructions' section.
	Frequent door openings. Large amount of food recently added.	Minimise door openings to allow temperature to stabilise.
<b>Food freezing in the refrigerator.</b>	Temperature setting not correct.	See 'Operating instructions' section.
	Food placed directly in front of air outlets.	Move chill sensitive foods away from the centre back of the shelves.
<b>Unfamiliar noises.</b>	Cabinet not stable or level.	See 'Installation instructions' section.
	Freezer is defrosting.	This is normal.
<b>Water in the vegetable bins.</b>	Condensation is formed by the water produced by fruit and vegetables.	A small amount of condensation is beneficial for fruit and vegetable storage. Wipe out water with a cloth.

All models		
Problem	Possible causes	What to do
Exterior of cabinet is warm.	This is normal.	–
Warm area on central door seal (French door models only).	This is normal.	–
Condensation on outside of refrigerator/freezer.	Not unusual during periods of high humidity.	Wipe dry.
Condensation inside fresh food compartment.	Frequent or long door openings.	Minimise door openings.
	Door gasket leaking.	Check that gasket is sitting flat and sealing tightly.
	Not unusual during periods of high humidity.	Wipe dry.
Door handles out of alignment.	With time and usage, movement may occur.	See 'Installation Instructions' section.
Tray/bin does not slide in and out evenly.	Packaging trapped.	Check to ensure no food or packaging is trapped behind the tray/bin.
	Runners not extending fully.	Holding onto sides of tray/bin, extend the runners fully by using a firm pull – this will reset the runner.
Ice cubes taste tainted.	Unsealed packages may be transmitting odour/taste.	Discard ice cubes and clean ice storage bin. See 'Cleaning Care – Interior' section.
		Wrap or cover strong smelling foods.
Excessive gasket noise.	May be due to a build up of dirt and/or grime.	See 'Cleaning Care – Exterior' section.
Door not closing.	An obstruction is blocking door closing.	Move obstruction.
	Soft closing door feature failure (soft closing door models only).	Soft closing door feature is not serviceable by user.
Appliance operating inefficiently.	Accumulation of dust on or behind the rear compartment cover.	Refer to 'Cleaning care' section. If problem persists please contact Customer Care.

## Ice & Water models only

Problem	Possible causes	What to do
<b>Automatic ice maker does not work.</b>	Ice maker has not been turned on.	Switch on ice maker, see 'Using your ice maker' section.
	Bin is in the wrong way or there is no bin in place.	Place bin so scoop is on the right side. Ice bin sits directly under ice maker on top left side of freezer.
	Water supply turned off or not connected.	Connect water supply.
	Freezer compartment not working.	Contact Customer Care.
	Water pressure too low.	Check water pressure.
	Water line kinked/squashed.	Check water line for kinks/squashing.
	Filter clogged.	Water filter may need replacing.
<b>Ice cubes taste tainted.</b>	Unsealed packages may be transmitting odour/taste.	Discard ice cubes and wrap or cover strong smelling foods.
	Interior of freezer needs cleaning.	Clean ice storage bin. See 'Cleaning Care – Interior' section.
	Poor taste from incoming water.	Filter may need changing. A new filter may need to be installed.
<b>Slow ice cube freezing.</b>	Door may have been left ajar.	Close door.
	Freezer compartment too warm.	Turn temperature to a colder setting. (See 'Operating instructions' section).
<b>Warm spot on central door seal. (French door models only)</b>	You may feel a warm spot at times on the central seal between the two refrigerator doors.	This is perfectly normal and is part of the normal refrigerator operation.
<b>Wet ice/ ice clumping.</b>	Low water pressure.	Check water pressure.
	Filter blocked.	Replace filter cartridge, see 'Water filter' section.
	Long freezer door openings. High ambient temperature. Ice bin left out of freezer compartment for a length of time. Ice will stick together over time.	Gently tap ice with scoop to unstick or, if large clumps occur, empty ice bin and make new ice.

Ice & Water models only		
Problem	Possible causes	What to do
Water has poor taste/odour.	Refrigerator not used for an extended period.	Dispense 10 litres (10 qt) of water through the water filter to replenish with a fresh water supply.
Water dispenser does not work.	Water supply turned off or not connected.	Turn water on. Run your water dispenser pad until water dispenses, this will displace trapped air in the water tank and filter system. This will take at least 2 minutes. Once water has dispensed reset the dispenser pad for 2 minutes.
	Supply line may be blocked. On first installation there may be air trapped in water system.	Check supply for kinks or leaks. To remove air, run 4 litres (4 qt) of water through the dispenser.
	Filter may be blocked and need replacing.	Replace filter cartridge, see 'Water filter' section.
	DISPENSER LOCK activated.	Press and hold the  button for 4 seconds.
	Water frozen in tank.	Increase temperature to a warmer setting in fresh food compartment and freezer.
Water in first glass is warm.	Water dispenser not used for extended period.	Discard first glass of water dispensed.
	Tank capacity used recently.	Allow water time to cool.
Filter warning light  is flashing.	Filter needs replacing.	Replace filter cartridge, see 'Water filter' section.
Drips overflow drip-shelf.	Air trapped in tank.	Flush 4 litres (4 qt) water through dispenser, stopping intermittently.
	New filter installed.	Flush 10 litres (10 qt) water through filter and then 4 litres (4 qt) through dispenser.
Water flow rate has slowed down.	Filter cartridge is restricted.	Replace filter cartridge, see 'Water filter' section.
Ice buildup inside freezer compartment.	Freezer door not closing tightly.	Arrange items in freezer so door can close tightly. Check and clean door gasket seal.
Ice maker makes unfamiliar sounds or seems too loud.	Normal ice maker operation.	See 'User warnings and sounds' section
Ice boost function not increasing rate of ice production.	Ambient temperature very warm. Refrigerator is in high usage.	Minimise door openings.

You automatically receive a 2 year Manufacturer's Warranty with the purchase of this refrigerator covering parts and labour for servicing within the countries: New Zealand, Australia, Singapore and The Republic of Ireland and Northern Ireland. All other countries are excluded.

## **Fisher & Paykel undertakes to:**

Repair or, at its option, replace without cost to the owner either for material or labour any part of the Product, the serial number of which appears on the Product, which is found to be defective within TWO YEARS of the date of purchase.

### **Note**

This Manufacturer's Warranty is an extra benefit and does not affect your legal rights.

## **This Manufacturer's Warranty DOES NOT cover**

- A** Service calls to which are not related to any defect in the Product. The cost of a service call will be charged if the problem is not found to be a Product fault. For example:
  1. Correcting the installation of the Product.
  2. Instructing you how to use the Product.
  3. Replacing house fuses or correct house wiring or plumbing.
  4. Correcting fault(s) caused by the user.
  5. Noise or vibration that is considered normal, eg drain/fan sounds, refrigeration noises or user warning beeps.
  6. Correcting damage caused by pests, eg rats, cockroaches, etc.
  7. Replacement light bulbs.
- B** Defects caused by factors other than:
  1. Normal domestic use or
  2. Use in accordance with the Product's User Guide.
- C** Defects to the Product caused by accident, neglect, misuse or Act of God.
- D** The cost of repairs carried out by non-authorized repairers or the cost of correcting such unauthorised repairs.
- E** Normal recommended maintenance as set out in the Product's User Guide.
- F** Repairs when the appliance has been dismantled, repaired or serviced by other than a Fisher & Paykel Authorised Repairer or the selling dealer.
- G** Pick-up and delivery.
- H** Transportation or travelling costs involved in the repair when the Product is installed outside the Fisher & Paykel Authorised Repairer's normal service area.
- I** Filter replacement except in the case of faulty parts or materials within the filter cartridge.
- J** Damage (including water damage) caused by faulty installation or plumbing.

This Product has been designed for use in a normal domestic (residential) environment. This Product is not designed for commercial use (whatsoever). Any commercial use by a Customer will affect this Product's Manufacturer's Warranty.

## Manufacturer's Warranty

Service under this Manufacturer's Warranty must be provided by a Fisher & Paykel Authorised Repairer (refer to the 'Customer care' section at the back of this book). Such service shall be provided during normal business hours. This Manufacturer's Warranty certificate should be shown when making any claim.

### **For Australian Customers**

This Manufacturer's Warranty is an extra benefit and does not affect your legal rights. Our goods come with guarantees that cannot be excluded under the Australian Consumer Law. You are entitled to a replacement or refund for a major failure and for compensation for any other reasonably foreseeable loss or damage. You are also entitled to have the goods repaired or replaced if the goods fail to be of acceptable quality and the failure does not amount to a major failure.

**Please keep this User Guide in a safe place.**

## Before you call for service or assistance...

Check the things you can do yourself.

Refer to your User Guide and check:

- 1 Your appliance is correctly installed.
- 2 You are familiar with its normal operation.
- 3 You have read the problem solving at the back of the book.

If after checking these points you still need assistance, please refer to your nearest Fisher & Paykel Authorised Repairer, or contact us through our website listed on the back cover.

## In New Zealand if you need assistance...\*

Call your Fisher & Paykel retailer who is trained to provide information on your appliance, or if we can be of any further help, please contact our Customer Care Centre.

**Toll Free:** 0800 FP CARE or 0800 372 273

**Fax:** (09) 273 0656

**Website:** [www.fisherpaykel.com](http://www.fisherpaykel.com)

**Postal address:** Fisher & Paykel Appliances Ltd, PO Box 58550, Botany, Auckland 2163

## If you need service...\*

Fisher & Paykel has a network of independent Fisher & Paykel Authorised Repairers whose fully trained technicians can carry out any service necessary on your appliance. Your dealer or our Customer Care Centre can recommend a Fisher & Paykel Authorised Repairer in your area.

## In Australia if you need assistance...\*

Call the Fisher & Paykel Customer Care Centre and talk to one of our Customer Care Consultants.

**Toll Free:** 1300 650 590

**Fax:** (07) 3826 9298

**Website:** [www.fisherpaykel.com](http://www.fisherpaykel.com)

**Postal address:** Fisher & Paykel Appliances Ltd, PO Box 798, Cleveland QLD 4163

## If you need service...\*

Fisher & Paykel has a network of Fisher & Paykel trained and supported service technicians responsible for servicing only Fisher & Paykel branded appliances. Our Customer Care Centre can recommend a Fisher & Paykel trained and supported service technician in your area.

## In United Kingdom if you need assistance...\*

**Phone:** 08000 886 605

**Fax:** 08000 886 606

**Website:** [www.fisherpaykel.com](http://www.fisherpaykel.com)

**Postal Address:** Fisher & Paykel Appliances Ltd, Maidstone Road, Kingston, Milton Keynes, Buckinghamshire, MK10 0BD

**In Ireland if you need assistance...\*****Phone:** 1800 625 174 or 01-8077960**Fax:** 1800 635 012**Website:** [www.fisherpaykel.com](http://www.fisherpaykel.com)**Postal address:** Fisher & Paykel Appliances, Unit D2, North Dublin Corporate Park, Swords, Co. Dublin**In Singapore if you need assistance...\***

Please call our Fisher &amp; Paykel Service line.

**Phone:** 6741 0777**Fax:** 6547 0123**Website:** [www.fisherpaykel.com](http://www.fisherpaykel.com)**Postal address:** Fisher & Paykel Appliances PTE Ltd, 150 Ubi Avenue 4, Sunlight Building ##03-01A, Singapore 408825**For the rest of the world...\***

Call your Fisher &amp; Paykel retailer/dealer from whom you purchased the product. They are trained to provide information on your appliance. If we can be of any further help, please contact us on:

**Phone:** +64 9 273 0660**Fax:** +64 9 273 0580**Website:** [www.fisherpaykel.com](http://www.fisherpaykel.com)**Postal address:** Fisher & Paykel Appliances Ltd, PO Box 58550, Botany, Auckland 2163, New Zealand

\*If you call, write or contact our website please provide: your name and address, model number, serial number, date of purchase and a complete description of the problem. This information is needed in order to better respond to your request for assistance.

**Product details**

Fisher &amp; Paykel Appliances

**Model** \_\_\_\_\_ **Serial no.** \_\_\_\_\_**Date of purchase** \_\_\_\_\_ **Purchaser** \_\_\_\_\_**Dealer** \_\_\_\_\_ **Suburb** \_\_\_\_\_**Town** \_\_\_\_\_ **Country** \_\_\_\_\_

# European directive 2012/19/EU on Waste Electrical and Electronic Equipment (WEEE) 55

**EU** This appliance is marked according to the European directive 2012/19/EU on Waste Electrical and Electronic Equipment (WEEE). By ensuring this product is disposed of correctly, you will help prevent potential negative consequences for the environment and human health, which could otherwise be caused by inappropriate handling of this product.

The symbol  marked on the serial plate, or on the documents accompanying the product, indicates that this appliance cannot be treated as household waste. It shall be handed over to the applicable collection point for the recycling of electrical and electronic equipment. Disposal of the appliance shall be carried out in accordance with the local environment regulations for waste disposal and ensure the refrigerant circuit is not damaged.

For more detailed information about treatment, recovery and recycling of this product, please contact your local city office, your household waste disposal service or your Fisher & Paykel retailer/dealer from whom you purchased this product.

State of California  
Department of Health Services  
Water Treatment Device  
Certificate Number

06 - 1806

Date Issued: July 18, 2006

**Trademark/Model Designation**

Fisher & Paykel 836860

**Replacement Elements**

836848

**Manufacturer:** Cuno Incorporated

The water treatment device(s) listed on this certificate have met the testing requirements pursuant to Section 116830 of the Health and Safety Code for the following health related contaminants:

**Microbiological Contaminants and Turbidity**

Cysts  
Turbidity

**Inorganic/Radiological Contaminants**

Asbestos  
Lead  
Mercury

**Organic Contaminants**

Atrazine  
Benzene  
Carbofuran  
Lindane  
p-dichlorobenzene  
Toxaphene

**Rated Service Capacity:** 750 gal

**Rated Service Flow:** 0.78 gpm

**Conditions of Certification:**

Do not use where water is microbiologically unsafe or with water of unknown quality, except that systems certified for cyst reduction may be used on disinfected waters that may contain filterable cysts.

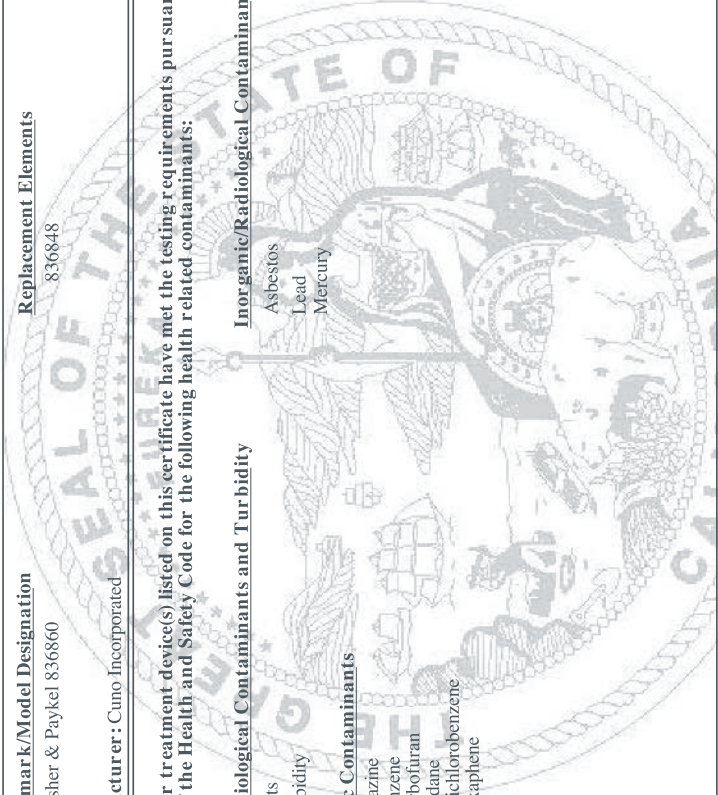

# Performance Data Sheet For Fisher & Paykel Filter System Model: 836860

## Replacement Cartridge: 836848

This system has been tested according to NSF/ANSI 42 and 53 for the reduction of the substances listed below. The concentration of the substances in water entering the system was reduced to a concentration less than or equal to the permissible limit for water leaving the system as specified in NSF/ANSI 42 & 53.

System tested and certified by NSF International against NSF/ANSI Standard 53 for the reduction of Asbestos, Atrazine, Benzene, Cyst, Carbofuran, Lead, Lindane, Mercury, P-Dichlorobenzene, Toxaphene and Turbidity; against Standard NSF/ANSI 42 for the reduction of Chlorine Taste and Odor and Nominal Particulate Class 1.

Note that while the testing was performed under standard laboratory conditions, actual performance may vary.



To a capacity of 2,838 liters (750 gallons)

Substance	USEPA MCL	Influent Challenge concentration (mg/L)	Standard 53: Health Effects		Effluent		% Reduction		Min. Required Reduction
			Influent Average	Effluent Average	Maximum	Maximum	Average	Maximum	
Turbidity	1 NTU**	11±1 NTU**	10.7 NTU**	0.31 NTU**	0.49 NTU**	<1	<1	95.20%	95.20%*
Cysts	99.95% reduction	Minimum 50,000 #/L 10 <sup>7</sup> to 10 <sup>8</sup> fibers/L;	166500 #/L	<1	#/L	<1	#/L	<99.99%	<99.99%
Asbestos	99% reduction	fibers greater than 10 um in length	155 MF/L	<1	MF/L	<1	MF/L	<99.99%	<99%
Lead @ pH 6.5	0.015 mg/L	0.15mg/L ±10%	0.153 mg/L	<0.001 mg/L	<0.001 mg/L	<0.001 mg/L	<0.001 mg/L	99.35%	99.29%
Lead @ pH 8.5	0.015 mg/L	0.15mg/L ±10%	0.150 mg/L	<0.001 mg/L	<0.001 mg/L	<0.001 mg/L	<0.001 mg/L	99.33%	99.29%
Mercury @ pH 6.5	0.002 mg/L	0.006mg/L ±10%	0.006 mg/L	0.0003 mg/L	0.0005 mg/L	0.0003 mg/L	0.0005 mg/L	95.70%	90.02 mg/L
Mercury @ pH 8.5	0.002 mg/L	0.006mg/L ±10%	0.006 mg/L	0.0008 mg/L	0.0015 mg/L	0.0008 mg/L	0.0015 mg/L	86.22%	75.31%
Atrazine	0.003 mg/L	0.009mg/L ±10%	0.009 mg/L	<0.002 mg/L	<0.002 mg/L	<0.002 mg/L	<0.002 mg/L	76.99%	75.31%
Benzene	0.005 mg/L	0.015mg/L ±10%	0.014 mg/L	0.0006 mg/L	0.0011 mg/L	0.0006 mg/L	0.0011 mg/L	95.74%	92.14%
Carbofuran	0.04 mg/L	0.08mg/L ±10%	0.081 mg/L	<0.001 mg/L	<0.001 mg/L	<0.001 mg/L	<0.001 mg/L	98.74%	98.46%
p-dichlorobenzene	0.075 mg/L	0.225mg/L ±10%	0.208 mg/L	<0.0005 mg/L	<0.0005 mg/L	<0.0005 mg/L	<0.0005 mg/L	99.76%	99.74%
Lindane	0.0002 mg/L	0.002mg/L ±10%	0.002 mg/L	0.000025 mg/L	0.00007 mg/L	0.000025 mg/L	0.00007 mg/L	98.72%	98.50%
Toxaphene	0.003 mg/L	0.015±10%	0.015 mg/L	<0.001 mg/L	<0.001 mg/L	<0.001 mg/L	<0.001 mg/L	92.97%	91.67%

### Standard 42: Aesthetic Effects

Substance	USEPA MCL	Influent Challenge concentration (mg/L)	Effluent		% Reduction		Min. Required Reduction
			Average	Maximum	Average	Maximum	
Chlorine Taste & Odor	~	2.0mg/L ±10%	1.88 mg/L	0.051366364 mg/L	0.06 mg/L	97.26%	96.84%
Nominal Particulate*	~	at least 10,000 particales/mL	5,700,000 #/ml	30,583 #/ml	69,000 #/ml	99.95%	98.94%

\* Measurement in Particles/ml. Particles used were 0.5 - 1 microns.

\*\*NTU = Nephelometric Turbidity Units

Operation Specifications	
Water pressure	172-827 kPa (25-120psi)
Water temperature	0.6-38°C (33-100°F)
Service flow	2.9 lpm (.78 gpm)
Filter capacity	2,838 liters (750gallons)

Systems must be installed and operated in accordance with manufacturer's recommended procedures and guidelines. Follow any and all local plumbing codes and requirements.

Some local codes may require the use of a licensed plumber or a certified installer when disrupting a potable water line.

**Important: Failure to follow instructions may result in voidance of warranty.**

**Important: Do not use with water that is microbiologically unsafe or of unknown quality without adequate disinfection before or after the system.** Systems certified for cyst reduction may be used on disinfected water may contain filterable cysts.

EPA Establishment Number 070595-MN-001

**Install on cold water line only.**

**IMPORTANT: Change the filter cartridge at least every 6 months.**

**CAUTION:** To reduce the risks associated with water leakage, which, if not avoided, may result in property damage - check with your plumbing professional to verify that water pressure is less than 827 kPa (120 psi).

For estimated cost of replacement element, please call 1-888-936-7872 or contact your local appliance distributor or dealer.

# Fisher & Paykel

Manufactured by : CUNO Incorporated, a 3M Company  
1000 Apollo Road  
Eagan, MN 55121

NSF is a registered trademark of National Sanitation Foundation.

© 3M Company. All rights reserved.  
INSTR7069 0706

[www.fisherpaykel.com](http://www.fisherpaykel.com)

***Fisher & Paykel***

Copyright © Fisher & Paykel 2015. All rights reserved.

The product specifications in this booklet apply to the specific products and models described at the date of issue. Under our policy of continuous product improvement, these specifications may change at any time. You should therefore check with your Dealer to ensure this booklet correctly describes the product currently available.