

KLIPSCH NEW YORK

MANUAL



LEGENDARY AMERICAN SOUND



SINCE 1946

TABLE OF CONTENTS

TABLE DES MATIÈRES • TABLA DE CONTENIDO • INHALTSVERZEICHNIS • INDICE • ÍNDICE • 目錄 • 目錄 • 目次 • 클립쉬 커넥트 플러스 앱

- 1. Klipsch Connect Plus App**
- 2. What's in the Box**
- 3. Product Overview**
- 4. Power and Battery**
- 5. Lighting Control**
- 6. Bluetooth Connection**
- 7. Aux Connection**
- 8. USB Connection**
- 9. Microphone/Guitar Input**
- 10. TWS Pairing**
- 11. Broadcast Mode Pairing**
- 12. Factory Reset**
- 13. Care and Cleaning**

KLIPSCH CONNECT PLUS APP

APPLICATION KLIPSCH CONNECT PLUS • APLICACIÓN KLIPSCH CONNECT PLUS • KLIPSCH CONNECT PLUS APP • APP KLIPSCH CONNECT PLUS • APLICATIVO KLIPSCH CONNECT PLUS

KLIPSCH CONNECT PLUS 应用程序 • KLIPSCH CONNECT PLUS 應用程式 • KLIPSCH コネクトプラスアプリ • 클립쉬 커넥트 플러스 앱

Scan the QR code for enhanced functionality.

Scannez le code QR pour une fonctionnalité améliorée. Escanee el código QR para obtener una funcionalidad mejorada. Scannen Sie den QR-Code für erweiterte Funktionalität. Scansiona il codice QR per funzionalità avanzate. Digitalize o código QR para funcionalidade aprimorada. 扫描二维码以获取增强功能。 掃描二維碼以取得增強功能。 拡張機能についてはQRコードをスキャンしてください。 향상된 기능을 보려면 QR 코드를 스캔하세요.

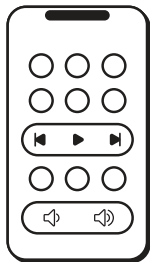

VIRTUAL REMOTE

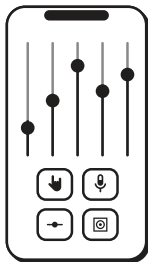

EQUALIZER

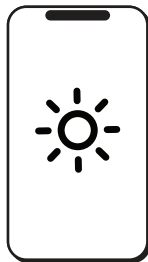

LIGHT SHOW CONTROL



SUPPORT

Virtual Remote Télécommande virtuelle Control remoto virtual Virtuelle Fernbedienung Telecomando virtuale Remoto virtual 虚拟遥控器 虛擬遙控器 仮想リモート 가상 원격	Equalizer Égaliseur Igalada Equalizer Equalizzatore Equalizador 均衡器 均衡器 イコライザ 평형 장치	Light Show Control Contrôle du spectacle lumineux Control del espectáculo de luces Lichtshow-Steuerung Controllo dello spettacolo di luci Controle de show de luzes 灯光秀控制 燈光秀控制 ライトショーコントロール 라이트 쇼 컨트롤	Support Soutien Apoyo Unterstützung Supporto Apoiar 支持 幫助 サポート 지원하다
---	---	--	---

INSIDE

CONTENU • CONTENIDO • INHALT • CONTENUTO • CONTEÚDO • 内 • 含量 • 内部 • 내용물 내부

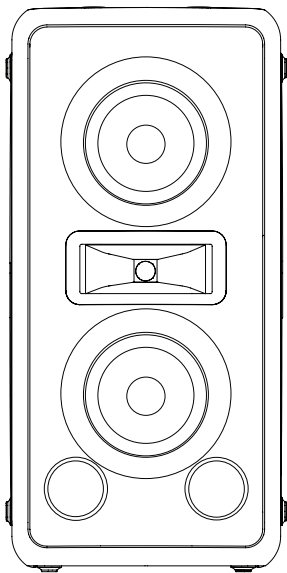

**SAFETY AND
WARRANTY
INFORMATION**

**QUICK
START
GUIDE**

CONTROLS

CONTRÔLES • CONTROLES • STEUERUNG • CONTROLLI • CONTROLES • 控制 • 控制装置 • コントロール • 통제 수단

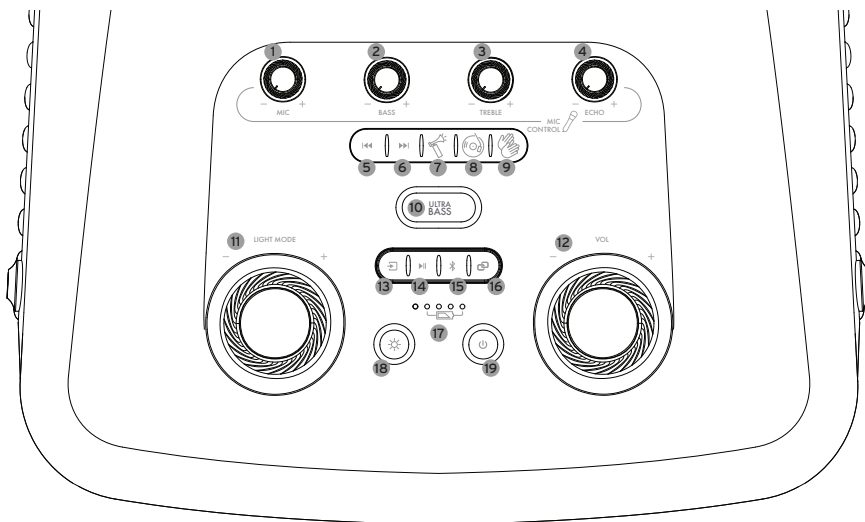

1. Microphone Volume Knob: Controls volume of microphone.
2. Bass Level Knob: Controls bass level of microphone input.
3. Treble Level Knob: Controls treble level of microphone input.
4. Echo Knob: Controls amount of echo in microphone.
5. Previous Button: Plays the previous song from the beginning.
6. Next Button: Plays the next song from the beginning.
7. Airhorn Button: Plays an airhorn sound effect.
8. Record Scratch Button: Plays a record scratch sound effect.
9. Applause Button: Plays an applause sound effect.
10. Ultra Bass Button: Enables ultra bass mode, boosting bass levels.

11. Light Mode Knob: Controls selection of light modes.
12. Volume Knob: Controls output volume of speaker.
13. Input Button: Controls which input the speaker is connected to. Only live inputs are available.
14. Play/Pause Button: Allows the user to play and pause the music.
15. Bluetooth Button: Used to connect the speaker to other devices. (phones, laptops, etc.)
16. TWS/Broadcast Button: Used to connect the speaker to other Music City Party speakers.
17. Battery Indicator Lights: Shows the current battery level.
18. Light Button: Toggle the light show on and off.
19. Power Button: Turns the speaker on and off.

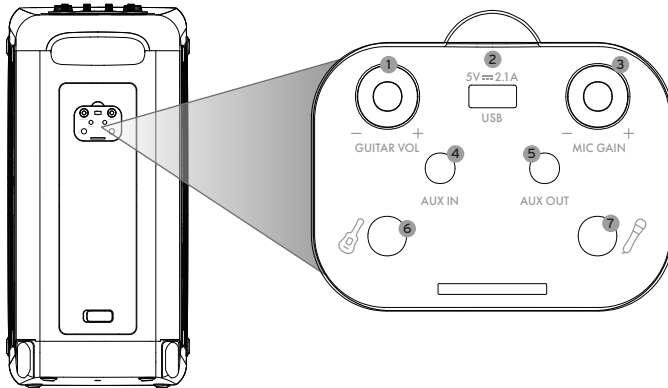

1. Guitar Volume Knob: Controls input level of guitar input.
2. USB Port: Allows reverse-charging of devices via USB connection and for firmware updates.
3. Microphone Gain Knob: Controls input level of microphone.
4. Aux Input: Allows input via Aux connection from compatible devices.
5. Aux Output: Allows output via Aux connection to compatible devices.
6. Guitar Input: Allows input via 1/4" cable connection for instruments.
7. Microphone Input: Allows input via 1/4" cable connection for microphones.

POWER AND BATTERY

PUISSANCE ET BATTERIE • POTENCIA Y BATERÍA • STROM UND BATTERIE • ALIMENTAZIONE E BATTERIA • POTÊNCIA E BATERIA • 電源和電池

電源和電池 • 電源とバッテリー • 전원 및 배터리

ON

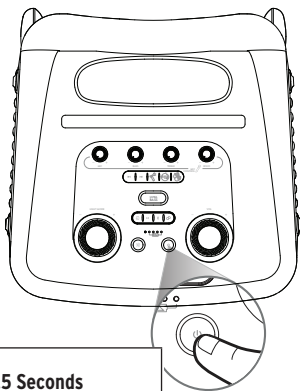

Hold >0.5 Seconds

Appuyer pendant >0.5 secondes
Mantenga oprimido durante >0.5 segundos
>0.5 Sekunden gedrückt halten
Tenere premuto per >0.5 secondi
Manter pressionado por >0.5 segundos
保持 >0.5 秒
維持 >0.5 秒
>0.5秒間押し続ける
>0.5초 동안 유지

OFF

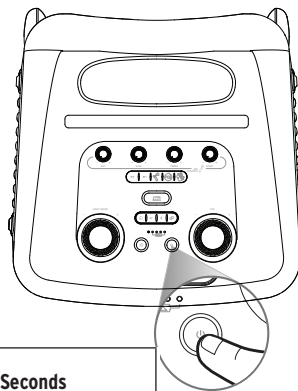

Hold 2 Seconds

Appuyer pendant 2 secondes
Mantenga oprimido durante 2 segundos
2 Sekunden gedrückt halten
Tenere premuto per 2 secondi
Manter pressionado por 2 segundos
保持 2 秒
維持 2 秒
2秒間押し続ける
2초 동안 유지

POWER AND BATTERY

PUISSANCE ET BATTERIE • POTENCIA Y BATERÍA • STROM UND BATTERIE • ALIMENTAZIONE E BATTERIA • POTÊNCIA E BATERIA • 电源和电池
電源和電池 • 電源とバッテリー • 전원 및 배터리

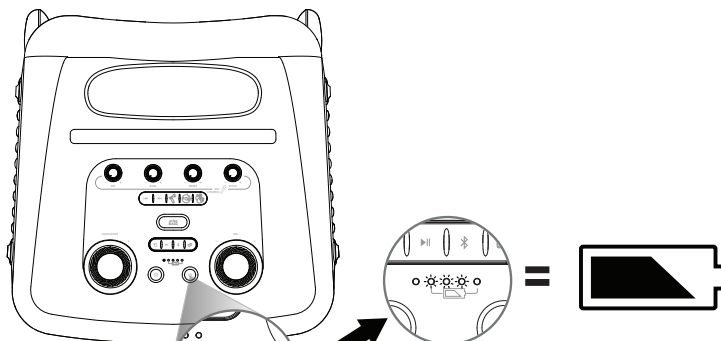

Press x1

Appuyer 1 fois
Oprima 1 vez
Ix drücken
Premere 1 volta
Pressionar uma vez
按 1 次
按x1
X1を押します
1번 누르기

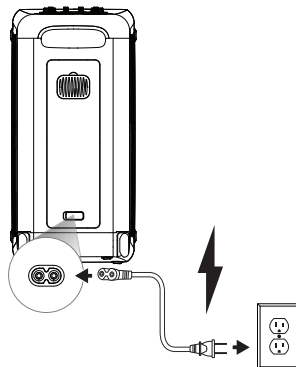

LIGHT CONTROL

CONTRÔLE DE LA LUMIÈRE • CONTROL DE LUZ • LICHTSTEUERUNG • CONTROLLO DELLA LUCE • CONTROLE DE LUZ • 灯光控制 • 光控 • 照明制御
조명 제어

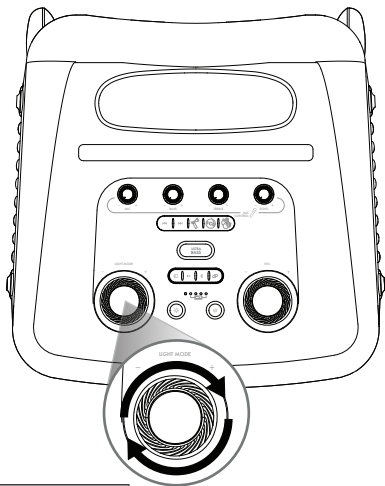

Turn

Tourner
Doblar
Drehen
Giro
Vez
转动
轉動
ターン
회전하다

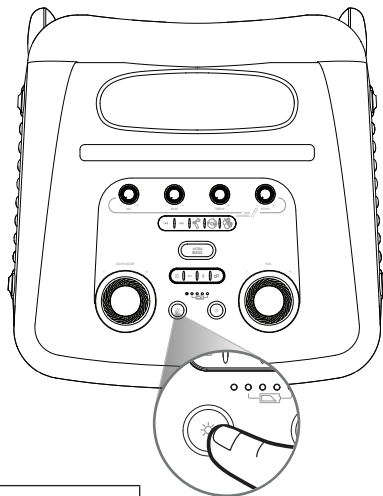
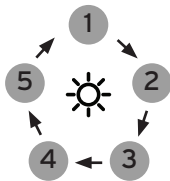

Press x1

Appuyer 1 fois
Oprima 1 vez
Ix drücken
Premere 1 volta
Pressionar uma vez
按 1 次
按 x1
X1 を押します
1번 누르기

FRONT + SIDE LIGHTS ON
↓
LIGHTS OFF
↓
FRONT LIGHT ON

BLUETOOTH® PAIRING MODE

MODE DE COUPLAGE **BLUETOOTH®** • MODO DE EMPAREJAMIENTO **BLUETOOTH®** • **BLUETOOTH®**-KOPPLUNGSMODUS • MODALITÀ DI ABBINAMENTO **BLUETOOTH®**
MODO DE EMPARELAMENTO **BLUETOOTH®** • **BLUETOOTH®** 配对模式 • **BLUETOOTH®** 配对模式 • **BLUETOOTH®**ペアリングモード
BLUETOOTH® 페어링 모드

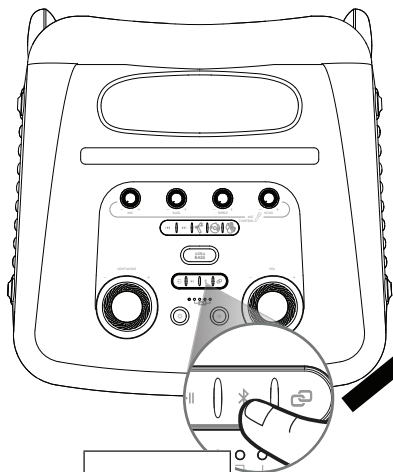

Press x1

Appuyer 1 fois
Oprima 1 vez
Ix drücken
Premere 1 volta
Pressionar uma vez
按 1 次
按 x1
X1 を押します
1번 누르기

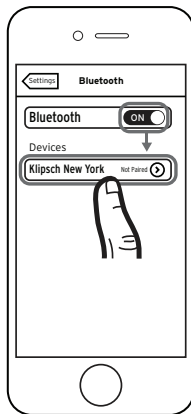

Blue / Flashing

Bleu / Clignotant
Azul / Destello
Blau / Blinkt
Blu / Lampeggiante
Azul / Intermitente
蓝色 / 闪烁
藍色 / 閃爍
青色 / 点滅
파란색 / 깜박임

CONNECTIONS - AUXILIARY

CONNEXIONS - AUXILIAIRE • CONEXIONES - AUXILIAR • ANSCHLÜSSE - AUX • CONNESSIONI - INGRESSO AUSILIARIO • CONEXÕES - AUXILIAR • 连接 - 辅助 • 接続 - 補助 • 연결 - 보조

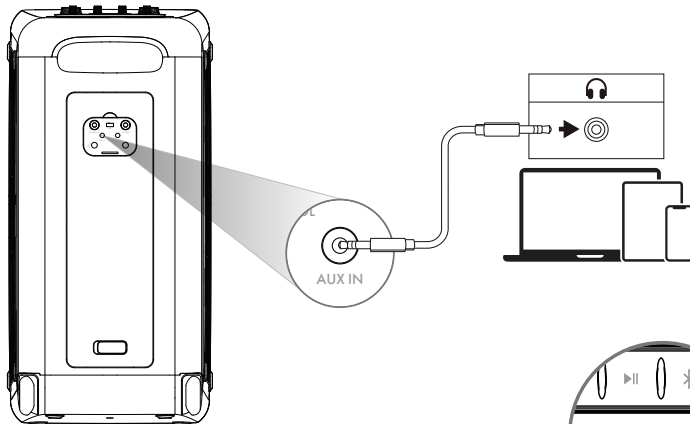

DAISY-CHAIN

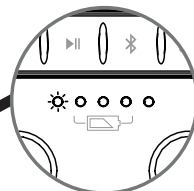
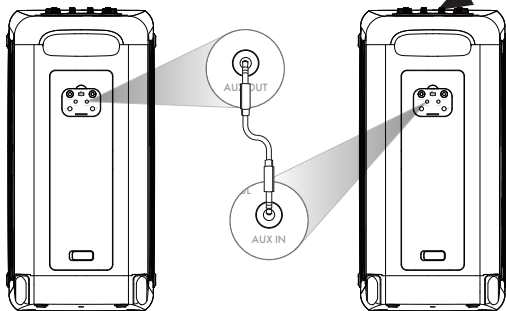

Green

Vert
Verde
Grün
Verde
Verde
綠色的
綠色的
綠
녹색

CONNECTIONS - USB

CONNEXIONS - USB • CONEXIONES - USB • ANSCHLÜSSE - USB • CONNESSIONI - USB • CONEXÕES - USB • 连接 - USB • 接続 - USB • 연결 - USB

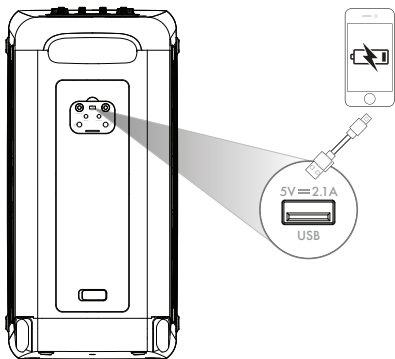

The Klipsch New York must be powered on to charge your device.

LE KLIPSCH NEW YORK DOIT ÊTRE SOUS TENSION POUR CHARGER VOTRE APPAREIL.
EL KLIPSCH NEW YORK DEBE ESTAR ENCENDIDO PARA CARGAR SU DISPOSITIVO.
DER KLIPSCH NEW YORK MUSS EINGESCHALTET SEIN, UM IHR GERÄT AUFZULADEN.
O KLIPSCH NEW YORK DEVE ESTAR LIGADO PARA CARREGAR SEU DISPOSITIVO.

IL KLIPSCH NEW YORK DEVE ESSERE ACCESSO PER CARICARE IL TUO DISPOSITIVO.

必須打开 KLIPSCH NEW YORK 才能为您的设备充电。

KLIPSCH NEW YORK 必須開機為您的裝置充電。

デバイスを充電するには、KLIPSCH NEW YORK の電源が入っている必要があります。

기기를 충전하려면 Klipsch New York의 전원이 켜져 있어야 합니다.

CONNECTIONS - USB

CONNEXIONS - USB • CONEXIONES - USB • ANSCHLÜSSE - USB • CONNESSIONI - USB • CONEXÕES - USB • 连接 - USB • 接続 - USB • 연결 - USB

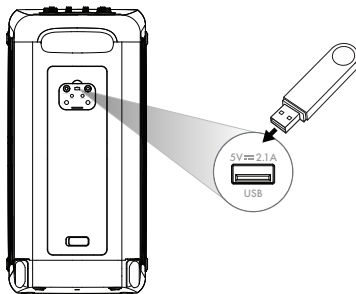

The USB feature is used for firmware updates, as well as playback of audio files. File formats supported are MP3 and WAV. The thumb drive must be formatted as FAT32.

La fonction USB permet les mises à jour du firmware et la lecture de fichiers audio. Les formats de fichiers pris en charge sont MP3 et WAV. La clé USB doit être formatée en FAT32.

La función USB se utiliza para actualizaciones de firmware y reproducción de archivos de audio. Los formatos de archivo compatibles son MP3 y WAV. La memoria USB debe estar formateada en FAT32.

Die USB-Funktion dient zum Aktualisieren der Firmware sowie zum Abspielen von Audiodateien. Unterstützte Dateiformate sind MP3 und WAV. Der USB-Stick muss im FAT32-Format formatiert sein.

La funzionalità USB è utilizzata per gli aggiornamenti del firmware e per la riproduzione di file audio. I formati di file supportati sono MP3 e WAV. La chiavetta USB deve essere formattata come FAT32.

O recurso USB é usado para atualizações de firmware, bem como reprodução de arquivos de áudio. Os formatos de arquivo suportados são MP3 e WAV. O pen drive deve ser formatado como FAT32.

USB 功能用于固件更新以及音频文件播放。支持的文件格式为 MP3 和 WAV。拇指驱动器必须格式化为 FAT32。

USB 功能用于軟體更新以及音訊檔案播放。支援的檔案格式是 MP3 和 WAV。此拇指驅動器必須格式化為 FAT32。

USB 機能は、ファームウェアのアップデートやオーディオファイルの再生に使用されます。サポートされているファイル形式は MP3 と WAV です。USB ドライブは FAT32 としてフォーマットする必要があります。

USB 기능은 펌웨어 업데이트와 오디오 파일 재생에 사용됩니다. 지원되는 파일 형식은 MP3와 WAV입니다. 썸 드라이브는 FAT32로 포맷해야 합니다.

CONNECTIONS - USB

CONNEXIONS - USB • CONEXIONES - USB • ANSCHLÜSSE - USB • CONNESSIONI - USB • CONEXÕES - USB • 连接 - USB • 接続 - USB • 연결 - USB

1

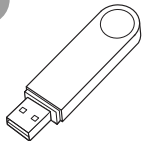

Ensure your thumb drive is formatted as FAT32 and contains MP3 or WAV files.

ASSUREZ-VOUS QUE VOTRE CLÉ USB EST FORMATÉE EN FAT32 ET CONTIENT DES FICHIERS MP3 OU WAV.
ASEGÚRESE DE QUE SU UNIDAD USB ESTÉ FORMATEADA COMO FAT32 Y CONTENGA ARCHIVOS MP3 O WAV.
STELLEN SIE SICHER, DASS IHR USB-STICK ALS FAT32 FORMATIERT IST UND MP3- ODER WAV-DATEIEN ENTHÄLT.
ASSICURATI CHE LA TUA CHIAVETTA USB SIA FORMATTATA COME FAT32 E CONTENGA FILE MP3 O WAV.
CERTIFIQUE-SE DE QUE SEU PEN DRIVE ESTEJA FORMATADO COMO FAT32 E CONTENHA AROUVIOS MP3 OU WAV.
確保您的拇指驅動器格式化為 FAT32 且包含 MP3 或 WAV 文件。
確保您的拇指驅動器格式化為 FAT32 且包含 MP3 或 WAV 檔案。

サムドライブが FAT32 としてフォーマットされ、MP3 または WAV ファイルが含まれていることを確認します。
썸 드라이브가 FAT32로 포맷되어 있고 MP3 또는 WAV 파일이 저장되어 있는지 확인하세요.

2

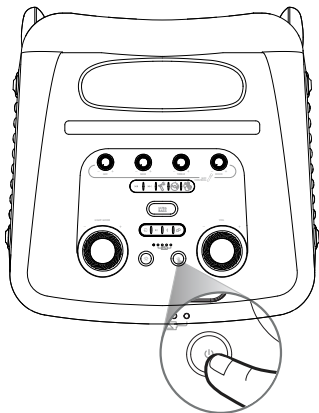

Power on the product and wait a few seconds for the device to fully come online.

ALLUMEZ LE PRODUIT ET ATTENDEZ QUELQUES SECONDES QUE L'APPAREIL SOIT COMPLÈTEMENT EN LIGNE.
ENCIENDA EL PRODUCTO Y ESPERE UNOS SEGUNDOS HASTA QUE EL DISPOSITIVO ESTÉ COMPLETAMENTE EN LÍNEA.
SCHALTEN SIE DAS PRODUKT EIN UND WARTEN SIE EINIGE SEKUNDEN, BIS DAS GERÄT VOLLSTÄNDIG ONLINE IST.
ACCENDERE IL PRODOTTO E ATTENDERE QUALCHE SECONDO AFFINCHÉ IL DISPOSITIVO SIA COMPLETAMENTE ONLINE.
LIGUE O PRODUTO E AGUARDE ALGUNS SEGUNDOS PARA QUE O DISPOSITIVO FIGUE TOTALMENTE ON-LINE.

打开产品电源并等待几秒钟让设备完全上线。

打開產品電源並等待幾秒鐘讓設備完全上線。

製品の電源を入れ、デバイスが完全にオンラインになるまで数秒待ちます。

제품의 전원을 켜고 장치가 완전히 온라인 상태가 될 때까지 몇 초 동안 기다리세요.

CONNECTIONS - USB

CONNEXIONS - USB • CONEXIONES - USB • ANSCHLÜSSE - USB • CONNESSIONI - USB • CONEXÕES - USB • 连接 - USB • 接続 - USB • 연결 - USB

3

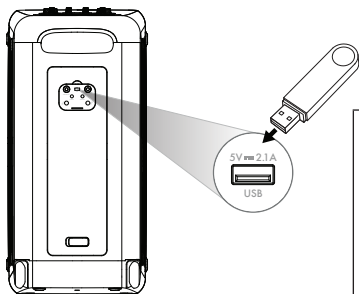

Insert the thumb drive into the USB port as shown.

INSÉREZ LA CLÉ USB DANS LE PORT USB COMME INDICUÉ.
INSERTE LA UNIDAD USB EN EL PUERTO USB COMO SE MUESTRA.
STECKEN SIE DEN USB-STICK WIE GEZEIGT IN DEN USB-ANSCHLUSS.
INSERIRE LA CHIAVETTA USB NELLA PORTA USB COME MOSTRATO.
INSIRA O PEN DRIVE NA PORTA USB, CONFORME MOSTRADO.
如图所示，将拇指驱动器插入 USB 端口。
如圖所示，將拇指驅動器插入 USB 連接埠。
図のように、USB ポートにサムドライブを挿入します。
그림과 같이 USB 포트에 썸 드라이브를 삽입합니다.

4

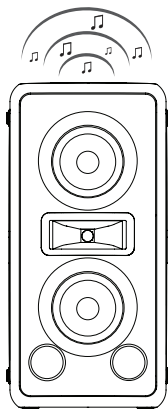

Audio files from the thumb drive should now be playing.

LES FICHIERS AUDIO DE LA CLÉ USB DEVRAIENT MAINTENANT ÊTRE LUS.
AHORA DEBERÍAN REPRODUCIRSE LOS ARCHIVOS DE AUDIO DE LA UNIDAD USB.
AUDIODATEIEN VOM USB-STICK SOLLTEN JETZT ABGESPIELT WERDEN.
ORA I FILE AUDIO DALLA CHIAVETTA USB DOVREBBERO ESSERE RIPRODOTTI.
OS ARQUIVOS DE ÁUDIO DO PEN DRIVE AGORA DEVEM ESTAR SENDO REPRODUZIDOS.
现在应该正在播放拇指驱动器中的音频文件。
現在應該正在播放拇指碟中的音訊檔案。
これで、サムドライブからのオーディオファイルが再生されるはずです。
이제 썸 드라이브의 오디오 파일이 재생되어야 합니다.

CONNECTIONS - 1/4" INPUT

CONNEXIONS - ENTRÉE 1/4" • CONEXIONES - ENTRADA 1/4" • ANSCHLÜSSE - 1/4" EINGANG • CONNESSIONI - INGRESSO 1/4" • CONEXÕES - ENTRADA 1/4"
连接 - 1/4" 输入 • 连接 - 1/4" 输入 • 接続 - 1/4" 入力 • 연결 - 1/4" 입력

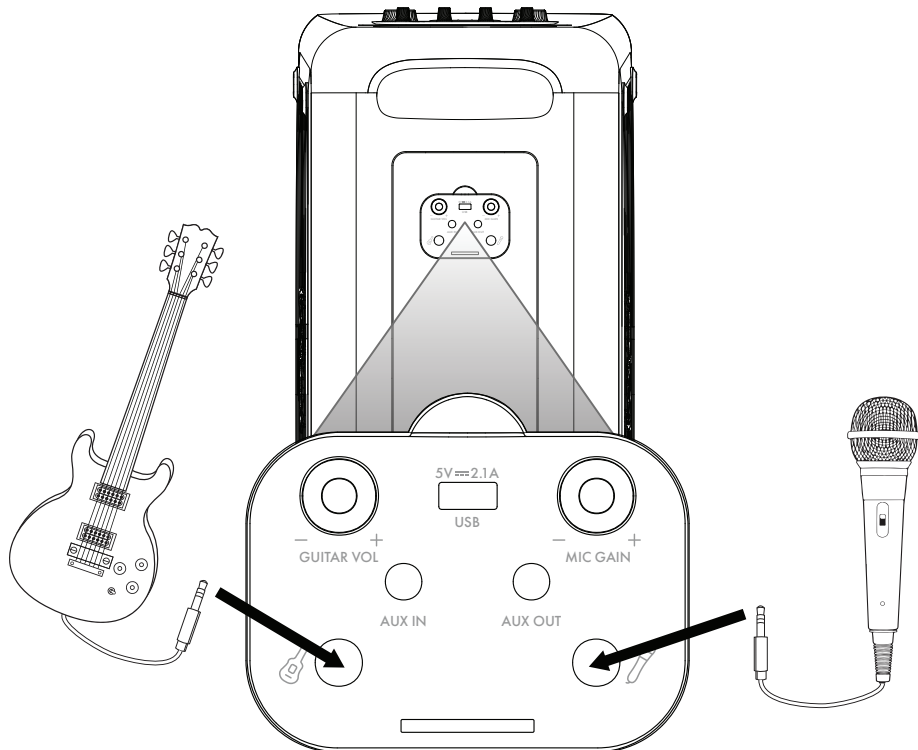

TRUE WIRELESS STEREO PAIRING

VÉRITABLE COUPLAGE STÉRÉO SANS FIL • VERDADERO EMPAREJAMIENTO ESTÉRÉO INALÁMBRICO • ECHE KABELLOSE STEREO-KOPPLUNG • VERO ACCOPPIAMENTO STEREO WIRELESS • EMPARELHAMENTO ESTÉRÉO SEM FIO VERDADEIRO

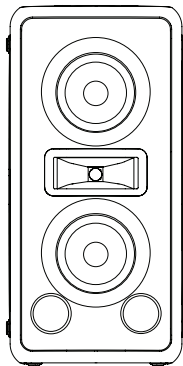
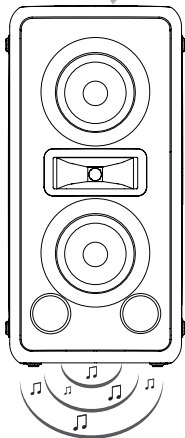
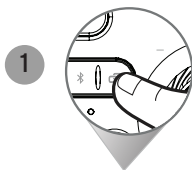
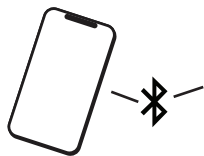

Hold >1 Second

Appuyer pendant >1 seconde
Mantenga oprimido durante >1 segundo
>1 Sekund gedrückt halten
Tenere premuto per >1 secondo
Manter pressionado por >1 segundo
保持 >1 秒
>1秒間押します
>1초 유지

TRUE WIRELESS STEREO PAIRING

VÉRITABLE COUPLAGE STÉRÉO SANS FIL • VERDADERO EMPAREJAMIENTO ESTÉRÉO INALÁMBRICO • ECHE KABELLOSE STEREO-KOPPLUNG • VERO ACCOPPIAMENTO STEREO WIRELESS • EMPARELHAMENTO ESTÉRÉO SEM FIO VERDADEIRO

2

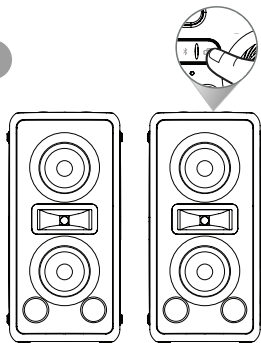

Press x1

Appuyer 1 fois
Oprima 1 vez
1x drücken
Premere 1 volta
Pressionar uma vez
按 1 次
按x1
X1を押します
1번 누르기

3

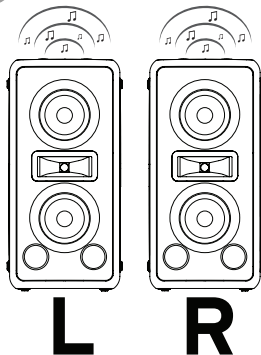

L

R

BROADCAST MODE PAIRING

COUPLAGE EN MODE DIFFUSION • EMPAREJAMIENTO DEL MODO DE TRANSMISIÓN • KOPPLUNG IM BROADCAST-MODUS • ACCOPIAMENTO IN MODALITÀ TRASMISIONE • EMPARELHAMENTO DO MODO DE TRANSMISSÃO • 广播模式配对 • ブロードキャストモードのペアリング • 브로드캐스트 모드 페어링

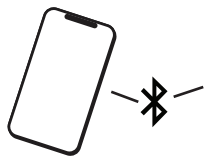

1

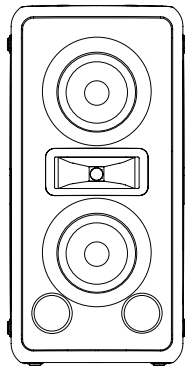
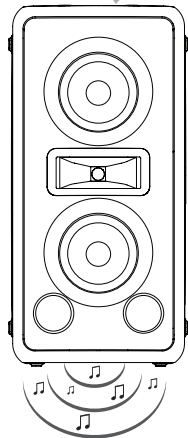
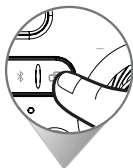

Press x2

Appuyer 2 fois

Oprima 2 vez

2x drücken

Premere 2 volta

Pressionar duas vez

按 2 次

按x2

X2를 押시 ㅁㅁ

2번 누르기

BROADCAST MODE PAIRING

COUPLAGE EN MODE DIFFUSION • EMPAREJAMIENTO DEL MODO DE TRANSMISIÓN • KOPPLUNG IM BROADCAST-MODUS • ACCOPIAMENTO IN MODALITÀ TRASMISIONE • EMPARELHAMENTO DO MODO DE TRANSMISSÃO • 广播模式配对 • ブロードキャストモードのペアリング • 브로드캐스트 모드 페어링

2

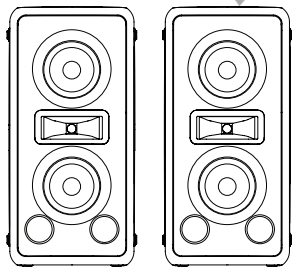

Press x1

Appuyer 1 fois
Oprima 1 vez
Ix drücken
Premere 1 volta
Pressionar uma vez
按 1 次
按x1
X1 を押します
1번 누르기

3

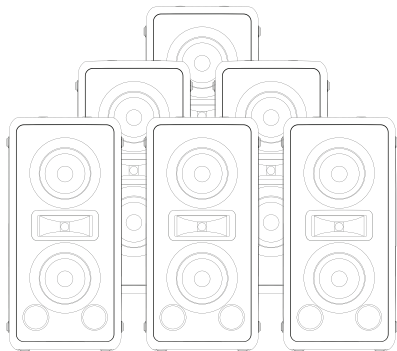
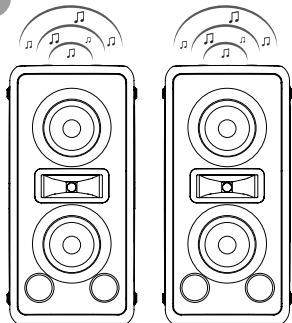

FACTORY RESET

RÉINITIALISATION • RESTABLECIMIENTO DE FÁBRICA • RÜCKSETZUNG AUF WERKSEINSTELLUNG • RIPRISTINO IMPOSTAZIONI DI FABBRICA
RESTABELECIMENTO DAS CONFIGURAÇÕES DE FÁBRICA • 恢复出厂设置 • 恢復出廠設定 • ファクトリーリセット • 공장 초기화

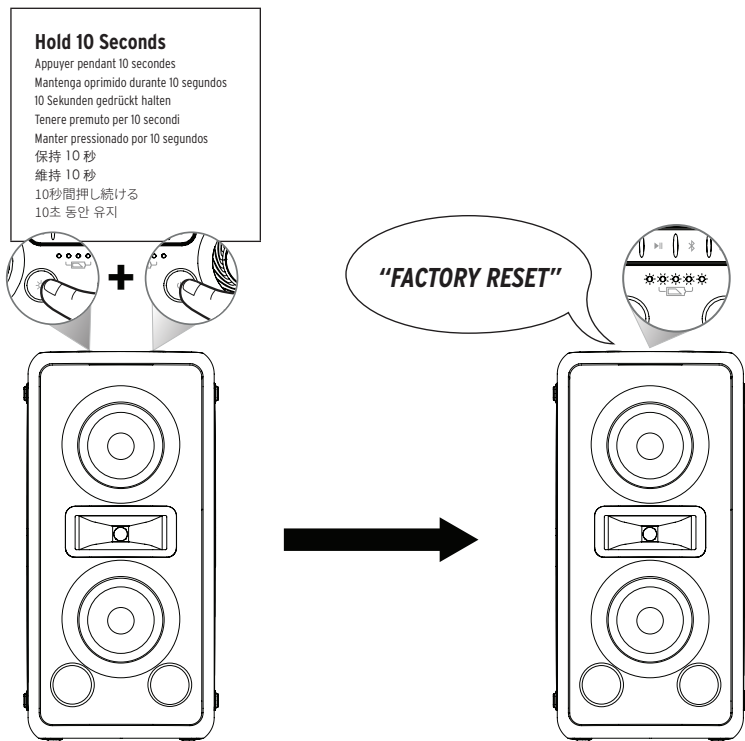

CARE AND CLEANING

ENTRETIEN ET NETTOYAGE • CUIDADO Y LIMPIEZA • PFLEGE UND REINIGUNG • CURA E PULIZIA • CUIDADOS E LIMPEZA • 保养与清洁 • お手入れ • 護理
和清潔 • 관리 및 청소

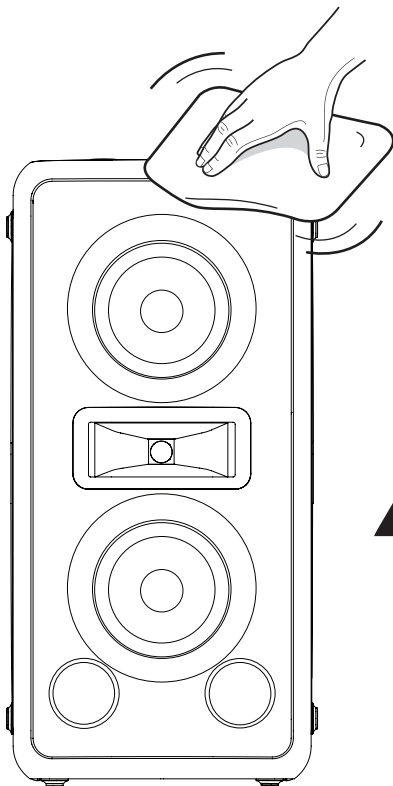

The Klipsch logo is rendered in a bold, black, handwritten-style script. The letter 'K' is particularly prominent, with a double-stroke effect on its vertical bar. The 'i' in 'Klipsch' has a small starburst or sparkle above it. A registered trademark symbol (®) is located at the end of the word.

3502 WOODVIEW TRACE, INDIANAPOLIS, IN, USA

KLIPSCH.COM

©2025 Premium Audio Company, LLC, a wholly owned subsidiary of Gentex Corporation (NASDAQ: GNTX). Klipsch and Keepers of the Sound are trademarks of Klipsch Group, Inc., registered in the United States and other countries. The *Bluetooth*® word mark is a registered trademark owned by Bluetooth SIG, Inc. and any use of such mark by Klipsch Group, Inc. is under license.

V06 - 260226