

User Manual

Enjoy Now, Master Your Moment

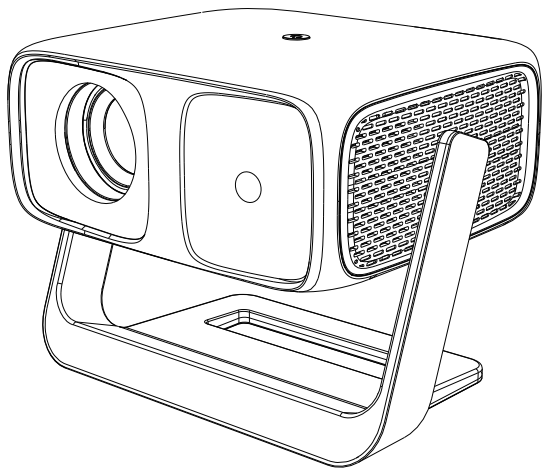

Model: K7

Please read this manual carefully before using the projector.

Catalogue

Important Safety Considerations	1
Projector Description	2
Remote Control Button Function	4
Quick Start	5
Screen Adjustment	7
Connection	11
Screen Casting & Mirroring	14
Google Assistant & Projector Settings	15
Specification	16
FAQS	17
FCC Statement	19
ISED Warning	20
TOP SERVICE	21

Important Safety Considerations

Attentions:

Thank you for purchasing this series of video projectors.

Please read through this User's manual for proper use of this product.



Friendly Reminder:

- 1 Do not look directly into the lens while the projector is running, as strong light may damage your eyes.
- 2 Do not block the air outlet to prevent the projector from cooling down because internal electronics are damaged.
- 3 Keep the projector and accessories out of the reach of children.
- 4 Please make sure that the working environment of the projector is dry and ventilated.
- 5 To prevent electric shock, please keep the projector out of the rain and away from moisture, it is recommended to switch off the projector after it has run for 6 hours non-stop.
- 6 Do not press hard on the projector, as it may damage the product.
- 7 Do not throw, hit, or shake the projector to avoid damaging the circuit board.
- 8 Any questions after receiving the projector, please contact us, we will quickly and correctly solve your problem within 24 hours and give you a satisfactory answer.

Package Contents

Power Cord *1

HDMI Cable *1

Remote Control *1

User Manual *1

Projector *1

Projector Description

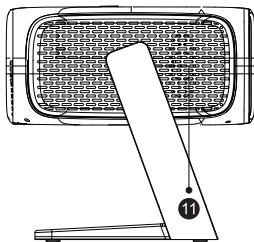
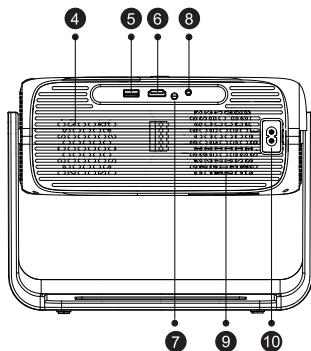
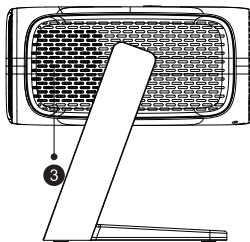
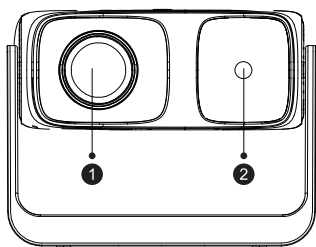

1. Lens

2. Camera

3. Air Outlet

4. Speaker

5. USB Port

6. HDMI Port

7. IR Receiver

8. Headphone Jack

9. Air Inlet

10. Power Jack

11. Speaker

Projector Description

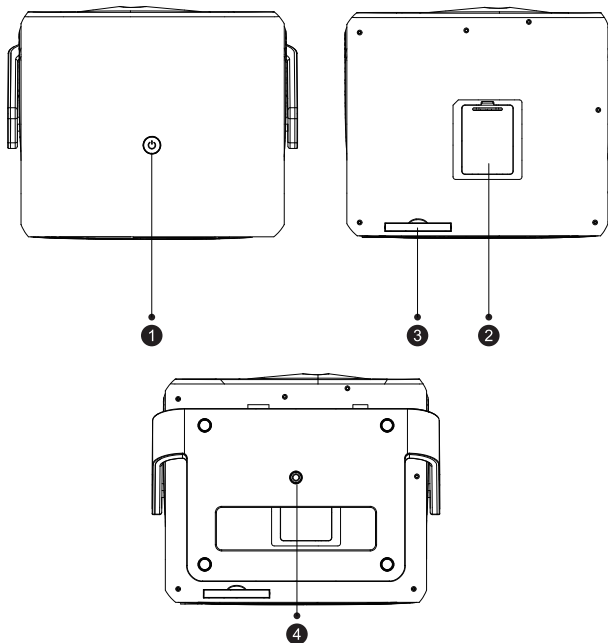

1. Power Key

2. Bottom Label

(Remove the Bottom Label & Dust Cover to clean up the dust.)

3. Dust Removal Button

Open the dust removal button, take out the dust filter inside, and clean it regularly (recommended once a month).

4. Hole for Stand

(M6, 1/4 inch)

Remote Control Button Function

1. Power

Press to power on/switch to standby mode / wake up /press and hold for 3s to power off

2. Google Assistant

Press and hold and talk

3. User Profile

Press to see profile page

4. OK

Confirm a selection/pause/resume

5. Back

Return to previous page

6. Pro Four Point Trapezoid

7. Mute

8. ① YouTube

Open the YouTube app

② Netflix

Open the Netflix app

③ Prime Video

Open the Prime Video app

9. Indicator Light

10. Input Source

Press to choose from input sources

11. Settings

Press to access dashboard

12. Navigation

Control cursor on the screen

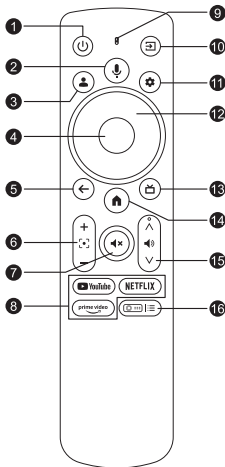

13. Live TV

Access Live TV (US only)

14.Home

Return to the home page

15. Volume +/-

16. Projector Setting (Shortcut)

Access projector setting shortcut menu

* Please install 2 AAA batteries (not included) into the remote control before use.

Projector Installation

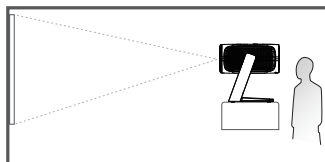

Front Desktop

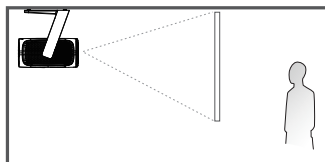

Rear Ceiling

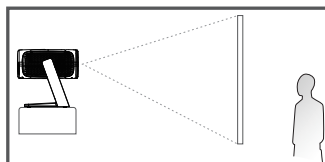

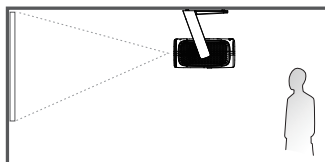

Rear Desktop



Front Ceiling

Note:

Whichever installation option you select, please make sure.

*To go to Homepage > Dashboard  > Settings  > Projector > Advanced Settings > Projection Mode to select the corresponding projection mode, so the images can be projected correctly.

Ceiling

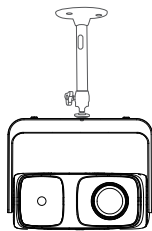
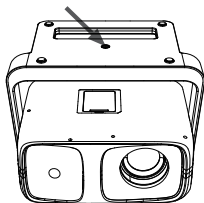

Tip: When ceiling mounting the projector, an additional mounting bracket is required. This projector uses a single-hole mounting bracket, so it is important to confirm the specifications before purchasing to avoid buying the wrong one.

Quick Start

Power On/Off

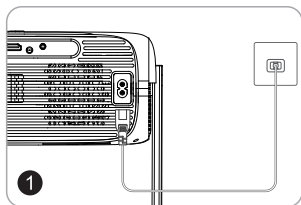

Take off the lens cover.
Connect the power adapter to an outlet.

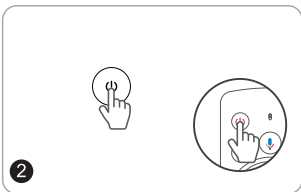

! Note:

1. Please use the projector power button for first boot. After start-up, complete the remote control pairing for remote usage.
2. When you sign in to your Google Account for the first time, it will take about 15 minutes to load the content and the progress bar will show the loading status, so please be patient.

Power on: When plug the power cord, the power light will turn on. Wait for 5 seconds, then press the power button, and the machine will start running normally.

Standby mode: Press the power button to enter standby mode in use.

Power off: Press the power button for 3 seconds to shut down.

Remote Control Pairing

Turn on the projector and wait for the pairing prompt on the screen. Bring the remote control within 0.33 ft/0 cm of the projector, then simultaneously press and hold the **⊖** and **⊕** buttons. Wait for the pairing to complete.

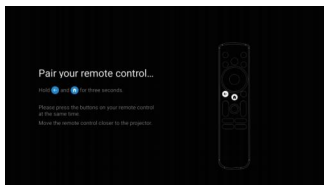

Tip:

We recommended pairing the remote control with the projector via Bluetooth before use. If you skip this, you can go to Homepage > Dashboard **⊕** > Settings **⊕** > Remotes & Accessories to pair the remote control via Bluetooth later.

Screen Adjustment

Auto Focus

When the projector detects shaking/rapid movement, it will automatically adjust the image quality. You can also trigger auto focus by going to Homepage > Dashboard (⊕) > Settings (⊕) > Projector > Focus > Auto Focus.

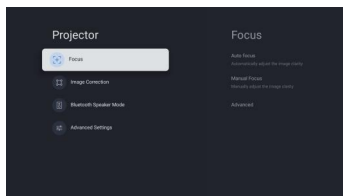

Electric / Manual Focus

Press the Focus buttons on the remote, or go to Homepage > Dashboard (⊕) > Settings (⊕) > Projector > Focus > Manual Focus and use the up & down buttons to sharpen the image focus until the blurry image becomes clear.

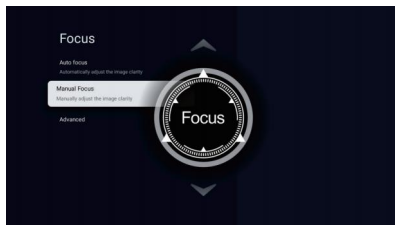
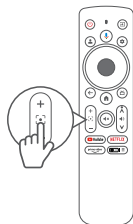

Tip:

Go to Homepage > Dashboard (⊕) > Settings (⊕) > Projector > Focus > Advanced, you can enable/disable:

Auto Focus at Startup, allowing the projector to automatically adjust the focus upon powering on.

Auto Focus When Moving, allowing the projector to automatically adjust the focus when it is moved.

Auto Keystone Correction

When the projector detects shaking/rapid movement, it will automatically correct the keystone distortion. You can also trigger auto keystone correction by going to Homepage > Dashboard ⊕ > Settings ⊕ > Projector > ImageCorrection > Auto Keystone Correction.

The optimal angle for automatic keystone correction is to keep it within 15°.

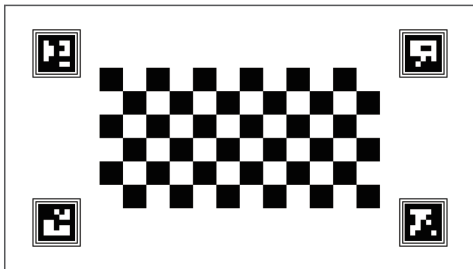
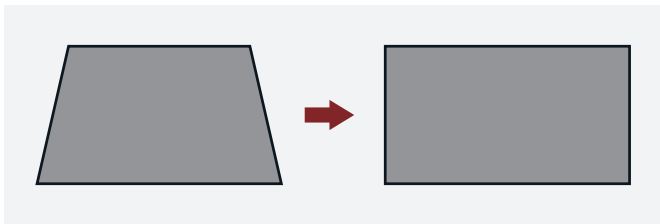

Tip:

Go to Homepage > Dashboard ⊕ > Settings ⊕ > Projector > Image Correction > Advanced, you can enable/disable:

Auto Keystone at Startup, allowing the projector to automatically correct the distortion upon powering on.

Auto Keystone When Moving, allowing the projector to automatically correct the distortion when it is moved.

Screen Adjustment

Manual Keystone Correction

Go to Homepage > Dashboard (⊕) > Settings (⊕) > Projector > image Correction > Manual Keystone Correction to manually correct the image shape by four points.

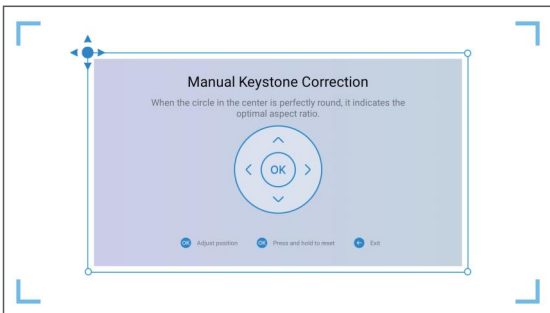

Screen Size Adjustment

Go to Homepage > Dashboard (⊕) > Settings (⊕) > Projector > Image Correction > Zoom & Shift > Zoom to reduce or enlarge the image size.

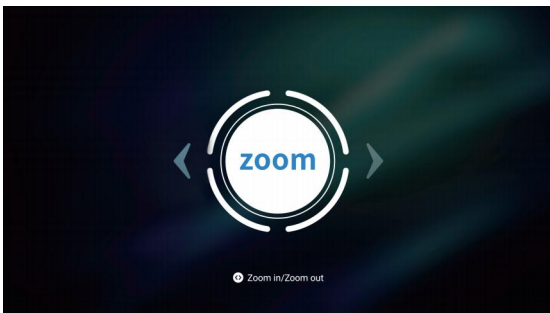

Screen Adjustment

Auto Screen Fit

Go to Homepage > Dashboard (⊕) > Settings (⊕) > Projector > Image Correction > Fit to Screen and follow the on-screen instructions, enabling the projector to automatically adjust the projected image to fit the screen.

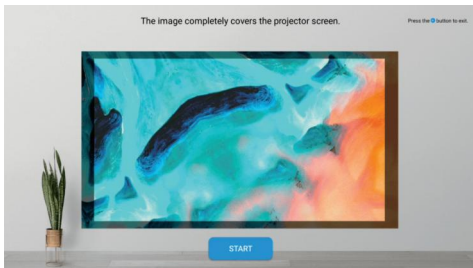

Intelligent Obstacle Avoidance

Go to Homepage > Dashboard (⊕) > Settings (⊕) > Projector > Image Correction > Advanced > Avoid Obstacles to enable the function. The projector will automatically adjust the projected image to avoid any objects on the projection surface.

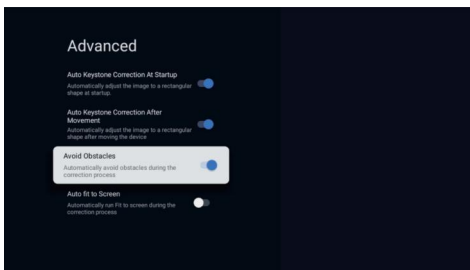

Connection

Connect your device to the projector correctly, then select the right input source.

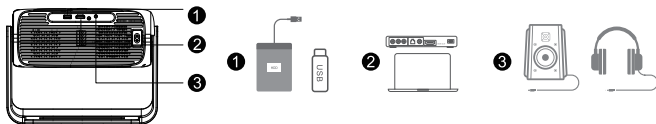

① **USB Connection:** Insert the disk. Then go to Homepage > Apps and select IMPlayer under Your apps tab to locate and play the file.

Tip:

For Basic TV, go to Homepage and select IMPlayer to locate and play the file.

② **HD Connection:** Connect the device, Then press Input button on the remote control or go to Homepage > Dashboard (⊕) > Inputs and select HD.

③ **Audio Connection:** Support 3.5mm earphones and other cable sound devices. Not required to select any input source.

Wi-Fi Connection

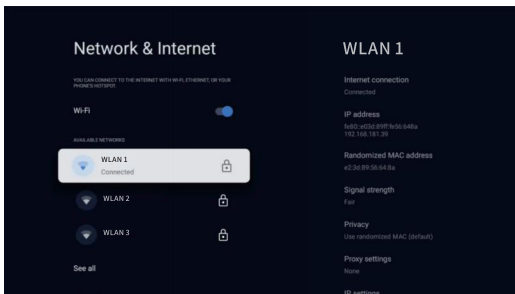

You can connect your projector to your router's WiFi by going to Homepage > Dashboard (⊕) > Settings (⊕) > Network & Internet.



Bluetooth Speaker Mode

You can use this projector as a Bluetooth speaker by connecting your mobile device to it through a Bluetooth connection.

Step 1:

Go to Homepage > Dashboard  > Settings  > Projector > Bluetooth Speaker Mode to make the projector ready for a Bluetooth connection.

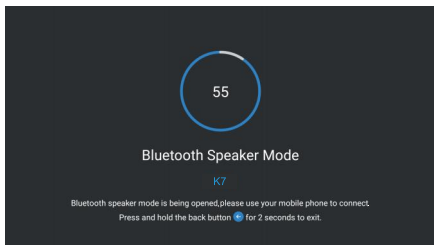

Step 2:

Access your mobile device's Bluetooth settings and activate Bluetooth. Search for K7 in the available devices list to pair your mobile device with the projector.

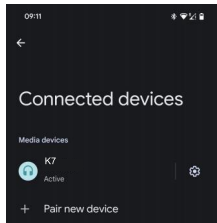
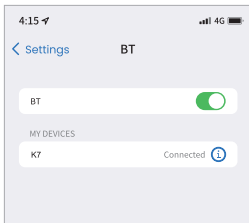

Tip:

To exit the Bluetooth Speaker Mode, simply press  button on the remote control for 2 seconds.

Bluetooth External Connection

You can connect your projector to other Bluetooth speaker devices.

Step 1:

Turn on your external Bluetooth devices.

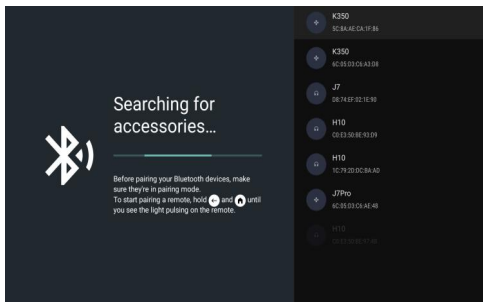
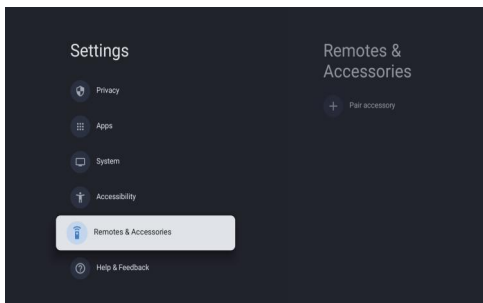

Step 2:

Go to Homepage > Dashboard (⊕) > Settings (⊕) > Remotes & Accessories > Pair accessory to scan and choose your external Bluetooth devices.

Screen Casting & Mirroring

You can wirelessly cast movies, games, music, and your screen from your iOS, macOS, Android™, or Windows device to the projector. Please make sure that the projector and your device are connected to the same wireless network.

1. Google Cast™

To stream entertainment from your favorite apps on your phone, tablet, or laptop to your projector follow the steps below:

1. Connect your device and the projector to the same wireless network.
2. Open a Google Cast-enabled app on your device.
3. Select the content that you would like to Cast, then tap the Cast icon  .
4. Select "K7" to connect. The projector will display the content from your device.

* Due to copyright restrictions, certain content cannot be cast to the projector, You can stream the content on the projector by installing same applications from the Apps tab.

2. Screen Mirroring via AirScreen

To cast the device screen:

You can project the entire screen from your device to the projector.

- ① Ensure that both your device and the projector are connected to the same wireless network.
- ② Search and install the AirScreen app on the projector.(AirCast /AirReceiver AirPlayCast DLNA/ Miracast TV Receiver - Cast)
- ③ Open the AirScreen app and follow the on-screen instructions to complete the process.

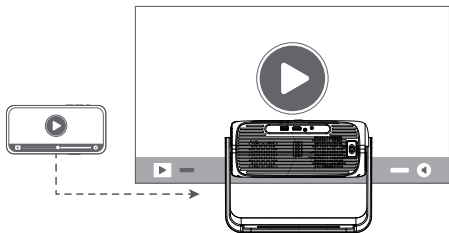

Note: Due to system upgrades, the name of casting app may be updated. Please search for apps with the keyword containing "AirPlay" in the Apps tab and try casting.

Google Assistant

Your TV is more helpful than ever. Use your voice to find movies, streaming apps, play music and control the TV. Ask Google Assistant to find a specific title, search by genre, or get personalized recommendations. Even get answers on screen, control smart home devices, and more. Press the Google Assistant button on the remote to get started.



Projector Settings

MORE SETTINGS

1. Color Temperature

Go to Homepage > Dashboard (⊕) > Settings (⊕) > Display&Sounds > Picture > Color Temperature to **select from** Standard, warm, Eye-care.

2. Reset

Go to Homepage > Dashboard (⊕) > Settings (⊕) > System > About > Reset to **restore the projector to factory settings.**

3. System & Product Info

Go to Homepage > Dashboard (⊕) > Settings (⊕) > System > About to **check system & product information.**

Specification

Model	K7
Display Technology	LCD
Light Source	LED
Resolution	1920*1080P
Installation Type	Front / Rear / Ceiling
Aspect Ratio	4:3 / 16:9
Focus	Auto and Electric
Keystone	Auto and Electric
Power Supply	AC 100-240V, 50/60Hz
Unit Dimension	10.63*8.54*8.28 inch
Unit Net Weigh	4.52 lb
Photo Format Supported	JPEG / BMP / GIF / PNG
Audio Format Supported	MPEG-2/4 / H.264/H.265 / VP8 / HEVC / MP3 / AAC / dd+(9630-B) / 3WAV / FLAC
Video Format Supported	MPEG-2/4 / MPEG_HD / HEVC / VC1 / AV1 / VP8 / H.264 / HDR10 / MOV / MKV
Mounting Screws	M6, 1/4"(not included)
Input Ports	HDMI *1,USB *1
Output Ports	3.5mm headphone
Working Temperature	0~35°C

Troubleshooting Guide

1. The copyrighted content from Hulu, Netflix, and similar services can not be mirrored or cast

* This projector offers a range of pre-installed streaming apps that are officially licensed. You can go to the homepage > Apps, search for the app, and log in to your account to play the content. For casting, refer to the "Screen Casting&Mirroring" section.

2. Fuzzy Image

- * Adjust the focus or keystone correction of the projector.
- * Make sure the projection distance is in the effective focal range of the projector.
- * Remove the dust or dirt from the lens with a blower or soft-bristled brush.

3. Non-rectangular Image

- * Place the projector perpendicular to the screen/wall if keystone correction function is not used.
- * Use the keystone correction function to adjust image shape.

4. Automatic keystone correction failure

- * Make sure the adjustment sensor on the front of the projector is not blocked or smudged.
- * Move the projector until it is perpendicular to the projection surface and try again.

5. Autofocus failure

- * Make sure the adjustment sensor on the front of the projector is not blocked or smudged.
- * Move the projector back and forth until the projector is in recommended projection distance.

6. Remote control unresponsive

- * Make sure the batteries are installed correctly and not drained.
- * Remove any obstructions between your projector and remote control.
- * Ensure the remote control is successfully paired with projector via Bluetooth.
- * Make sure no button is pressed or stuck and check if the power indicator is still on. If yes, please contact customer support or local service center.

7. Connect the Bluetooth devices

* Enter Homepage > Dashboard (⊕) > Settings (⊕) > Remotes & Accessories to check the Bluetooth device list, and connect the device.

Statement

Google TV is the name of this device's software experience and a trademark of Google LLC. Google, Android, YouTube and Google Cast are trademarks of Google LLC.



Manufactured under license from Dolby Laboratories, Dolby, Dolby Audio, and the double-D symbol are trademarks of Dolby Laboratories Licensing Corporation.



Netflix is a trademark of Netflix, Inc.



The terms HDMI, HDMI High-Definition Multimedia Interface, HDMI Trade dress and the HDMI Logos are trademarks or registered trademarks of HDMI Licensing Administrator, Inc.

FCC Statement

Any Changes or modifications not expressly approved by the party responsible for compliance could void the user's authority to operate the equipment. This device complies with part 15 of the FCC Rules.

Operation is subject to the following two conditions:

- (1) This device may not cause harmful interference, and
- (2) This device must accept any interference received, including interference that may cause undesired operation.

NOTE: This equipment has been tested and found to comply with the limits for a Class B digital device, pursuant to part 15 of the FCC Rules. These limits are designed to provide reasonable protection against harmful interference in a residential installation. This equipment generates, uses and can radiate radio frequency energy and, if not installed and used in accordance with the instructions, may cause harmful interference to radio communications. However, there is no guarantee that interference will not occur in a particular installation. If this equipment does cause harmful interference to radio or television reception, which can be determined by turning the equipment off and on, the user is encouraged to try to correct the interference by one or more of the following measures.

- Reorient or relocate the receiving antenna.
- Increase the separation between the equipment and receiver.
- Connect the equipment into an outlet on a circuit different from that to which the receiver is connected.
- Consult the dealer or an experienced radio/TV technician for help.

This equipment complies with FCC radiation exposure limits set forth for an uncontrolled environment.

This equipment should be installed and operated with minimum distance 20cm between the radiator & your body.

This transmitter must not be co-located or operating in conjunction with any other antenna or transmitter.

ISED Warning

This device complies with industry Canada licence-exempt RSS standard(s).

Operation is subject to the following two conditions:

- (1) This device may not cause interference, and
- (2) This device must accept any interference, including interference that may cause undesired operation of the device.

Le présent appareil est conforme aux CNR d'Industrie Canada applicables aux appareils radio exempts de licence.

L'exploitation est autorisée aux deux conditions suivantes.

- (1) l'appareil ne doit pas produire de brouillage, et
- (2) l'utilisateur de l'appareil doit accepter tout brouillage radioélectrique subi, même si le brouillage est susceptible d'en compromettre le fonctionnement.

The device is compliance with RF exposure guidelines, users can obtain Canadian information on RF exposure and compliance. The minimum distance from body to use the device is 20cm.

L'appareil est conforme aux directives d'exposition aux RF, les utilisateurs peuvent obtenir des informations canadiennes sur l'exposition aux RF et la conformité. La distance minimale du corps pour utiliser l'appareil est de 20cm.

This transmitter must not be co-located or operating in conjunction with any other antenna or transmitter. Cet émetteur ne doit pas être colocalisé ou fonctionner en conjonction avec une autre antenne ou un autre émetteur.

Operation of this device in the band 5150-5250 MHz is restricted to indoor use only.

Le fonctionnement de cet appareil dans la bande 5150-5250 MHz est limité à une utilisation en intérieur uniquement.

TOP SERVICE:

Any questions about this item, please contact.

 1-888-986-2646(US)

 US:service@happrunlife.com

 EU:service.eu@happrunlife.com

Please scan the QR code to watch the video for detailed steps.

