



**BUILT-IN COMBINATION OVEN
WITH MICROWAVE
OPERATION MANUAL**

MODEL:EV45EMWB

Read these instructions carefully before using your microwave oven, and keep it carefully.

If you follow the instructions, your oven will provide you with many years of good service.

SAVE THESE INSTRUCTIONS CAREFULLY

en Table of contents

Important safety information	2	Defrosting programmes.....	12
Causes of damage.....	6	Setting the time-setting options	12
Installation	6	Setting the cooking time.....	13
Your new appliance	8	Setting the clock.....	13
Control panel.....	8	Childproof lock	13
Touch keys and display.....	8	Switching on the childproof lock.....	13
Function selector.....	8	Switching off the childproof lock.....	13
Parameter selector.....	8	Childproof lock with automatic programmes.....	13
Cooling fan.....	8	Care and cleaning	14
Accessories.....	9	Cleaning agents.....	14
Before using the appliance for the first time	9	Technical data.....	14
Setting the clock.....	9	Malfunction table	15
Heating up the oven.....	9	Acrylamide in foodstuffs	15
Cleaning the accessories.....	9	Energy and environment tips	16
Setting the oven	9	Saving energy.....	16
Setting the type of heating and temperature.....	9	Environmentally-friendly disposal.....	16
Rapid preheating.....	10	Expert Cooking Guide	16
The microwave	10	Defrosting, heating up and cooking with the microwave.....	16
Notes regarding ovenware.....	10	Microwave tips.....	19
Microwave power settings.....	10	Cakes and pastries.....	19
Setting the microwave.....	11	Baking tips.....	20
MicroCombi operation	11	Roasting and grilling.....	21
Setting Microwave Combi operation.....	11	Tips for roasting and grilling.....	23
Automatic programmes	11	Bakes, gratins, toast with toppings.....	23
Setting a programme.....	11	Convenience products, frozen.....	24

Important safety information

Read these instructions carefully. Only then will you be able to operate your appliance safely and correctly. Retain the instruction manual for future use or for subsequent owners.

Check the appliance for damage after unpacking it. Do not connect the appliance if it has been damaged in transport.

The microwave oven is intended for heating food and beverages. Drying of food or clothing and heating of warming pads, slippers, sponges,

damp cloth and similar may lead to risk of injury, ignition or fire.

Only a licensed professional may connect appliances without plugs. Damage caused by incorrect connection is not covered under warranty.

This appliance is intended for domestic use only. The appliance must only be used for the preparation of food and drink. The appliance must be supervised during operation. Only use this appliance indoors.

This appliance can be used by children aged from 8 years and above and persons with reduced physical, sensory or mental capacity or lack of experience and knowledge if they have been given supervision or instruction concerning use of the the appliance in a safe way and understand the hazards involved.

Children shall not play with the appliance.

Cleaning and user maintenance shall not be made by children without supervision.

The appliances are not intended to be operated by means of an external timer or separate remote-control system.

This appliance is intended to be used in household and similar applications such as:

- staff kitchen areas in shops, offices and other working environments;
- farm houses;
- by clients in hotels, motels and other residential type environments; bed and breakfast type environments.

Risk of fire!

- Combustible items stored in the cooking compartment may catch fire. Never store combustible items in the cooking compartment. Never open the appliance door if there is smoke inside. Switch off the appliance and unplug it from the mains or switch off the circuit breaker in the fuse box.

- When heating food in plastic or paper containers, keep an eye on the oven due to the possibilities of ignition.
- If smoke is observed, switch off or unplug the appliance and keep the door closed in order to stifle any flames

WARNING : Accessible parts may become hot during use .Young children should be kept away.

WARNING : Do not use harsh abrasive cleaners or sharp metal scrapers to clean the microwave oven door glass since they can scratch the surface, which may result in shattering of the glass.

- Do not select a microwave power or time setting that is higher than necessary. Follow the information provided in this instruction manual. Never use the microwave to dry food. Never defrost or heat food with a low water content, e.g. bread, at too high a microwave power or for too long.
- Cooking oil may catch fire. Never use the microwave to heat cooking oil on its own.

Risk of explosion!

Liquids and other food may explode when in containers that have been tightly sealed. Never heat liquids or other food in containers that have been tightly sealed.

Only use utensils that are suitable for use in microwave ovens

Risk of serious damage to health!

- The surface of the appliance may become damaged if it is not cleaned properly. Microwave energy may escape. Clean the appliance on a regular basis, and remove any food residue immediately. Always keep the cooking compartment, door seal, door and door stop clean; see also section *Care and cleaning*.

WARNING: If the door or door seals are damaged, the oven must not be operated until it has been repaired by a competent person.

WARNING: It is hazardous for anyone other than a competent person to carry out any service or repair operation that involves the removal of a cover which gives protection against exposure to microwave energy.

- Microwave energy may escape if the cooking compartment door or the door seal is damaged. Never use the appliance if the cooking compartment door or the door seal is damaged. Contact the after-sales service.
- Microwave energy will escape from appliances that do not have any casing. Never remove the casing. For any maintenance or repair work, contact the after-sales service.

Risk of electric shock!

- Incorrect repairs are dangerous. Repairs may only be carried out and damaged power cables replaced by one of our trained after-

sales technicians. If the appliance is defective, unplug the appliance from the mains or switch off the circuit breaker in the fuse box. Contact the after-sales service.

- The cable insulation on electrical appliances may melt when touching hot parts of the appliance. Never bring electrical appliance cables into contact with hot parts of the appliance.
- Penetrating moisture may cause an electric shock. Do not use any high-pressure cleaners or steam cleaners.
- A defective appliance may cause electric shock. Never switch on a defective appliance. Unplug the appliance from the mains or switch off the circuit breaker in the fuse box. Contact the after-sales service.
- The appliance is a high-voltage appliance. Never remove the casing.

WARNING: Ensure that the appliance is switched off before replacing the lamp to avoid the possibility of electric shock.

Risk of burns!

- During use the appliance becomes hot. Care should be taken to avoid touching heating elements inside the oven.
- Accessories and ovenware become very hot. Always use oven gloves to remove accessories or ovenware from the cooking compartment.

- Alcoholic vapours may catch fire in the hot cooking compartment. Never prepare food containing large quantities of drinks with a high alcohol content. Only use small quantities of drinks with a high alcohol content. Open the appliance door with care.
- Foods with peel or skin may burst or explode during, or even after, heating. Never cook eggs in their shells or reheat hard-boiled eggs. Never cook shellfish or crustaceans. Always prick the yoke when baking or poaching eggs. The skin of foods that have a peel or skin, such as apples, tomatoes, potatoes and sausages, may burst. Before heating, prick the peel or skin.
- The contents of feeding bottles and baby food jars shall be stirred or shaken and the temperature checked before consumption, in order to avoid burns.
- Heated food gives off heat. The ovenware may become hot. Always use oven gloves to remove ovenware or accessories from the cooking compartment.

WARNING: Liquids and other foods must not be heated in sealed containers since they are liable to explode. Always observe the instructions on the packaging. Always use oven gloves to remove dishes from the cooking compartment.

Risk of scalding!

- When you open the appliance door,

hot steam may escape. Open the appliance door with care. Keep children at a safe distance.

- Microwave heating of beverages can result in delayed eruptive boiling, therefore care must be taken when handling the container. This means that the liquid reaches boiling temperature without the usual steam bubbles rising to the surface. Even if the container only vibrates a little, the hot liquid may suddenly boil over and spatter. When heating, always place a spoon in the container. This will prevent delayed boiling.

Risk of injury!

- Scratched glass in the appliance door may develop into a crack. Do not use a glass scraper, or sharp or abrasive cleaning aids or detergents.
- Unsuitable ovenware may crack. Porcelain or ceramic ovenware can have small perforations in the handles or lids. These perforations conceal a cavity below. Any moisture that penetrates this cavity could cause the ovenware to crack. Only use microwave-safe ovenware.

Metallic containers for food and beverages are not allowed during microwave cooking.

The appliance shall be situated more than 850 mm above the floor after installation.

Causes of damage

Caution!

- Creation of sparks: Metal - e.g. a spoon in a glass - must be kept at least 2 cm from the oven walls and the inside of the door. Sparks could irreparably damage the glass on the inside of the door.
- Water in the hot cooking compartment: Never pour water into the hot cooking compartment. This will cause steam. The temperature change can cause damage.
- Moist food: Do not store moist food in the closed cooking compartment for long periods.
Do not use the appliance to store food. This can lead to corrosion.
- Cooling with the appliance door open: Only leave the cooking compartment to cool with the door closed. Do not trap anything in the appliance door. Even if the door is only slightly ajar, the fronts of adjacent units may be damaged over time.
- Heavily soiled seal: If the seal is very dirty, the appliance door will no longer close properly during operation. The fronts of adjacent units could be damaged. Always keep the seal clean.
- Operating the microwave without food: Operating the appliance without food in the cooking compartment may lead to overloading. Never switch on the appliance unless there is food in the cooking compartment. An exception to this rule is a short crockery test (see the section "Microwave, suitable crockery").
- Using the appliance door for standing on or placing objects on: Do not stand or place anything on the open appliance door. Do not place ovenware or accessories on the appliance door.
- Transporting the appliance: Do not carry or hold the appliance by the door handle. The door handle cannot support the weight of the appliance and could break.
- Microwave popcorn: Never set the microwave power too high. Use a power setting no higher than 600 watts. Always place the popcorn bag on a glass plate. The disc may jump if overloaded.
- Liquid that has boiled over must not be allowed to run through the turntable drive into the interior of the appliance. Monitor the cooking process. Choose a shorter cooking time initially, and increase the cooking time as required.
- The oven should be cleaned regularly and any food deposits removed since they may explode, even after microwave heating has ended.
- Failure to maintain the oven in a clean condition could lead to deterioration of the surface that could adversely affect the life of the appliance and possibly result in a hazardous situation.

Installation

Fitted units

- This appliance is only intended to be fully fitted in a kitchen.
- This appliance is not designed to be used as a tabletop appliance or inside a cupboard.
- The fitted cabinet must not have a back wall behind the appliance.
- A gap of at least 45 mm must be maintained between the wall and the base or back panel of the unit above.
- The fitted cabinet must have a ventilation opening of 250 cm² on the front. To achieve this, cut back the base panel or fit a ventilation grille.
- Ventilation slots and intakes must not be covered.
- The safe operation of this appliance can only be guaranteed if it has been installed in accordance with these installation instructions.
- The fitter is liable for any damage resulting from incorrect installation.
- The units into which the appliance is fitted must be heat-resistant up to 90 °C.

Installation dimensions

Ventilation openings

behind, min. 250 cm²

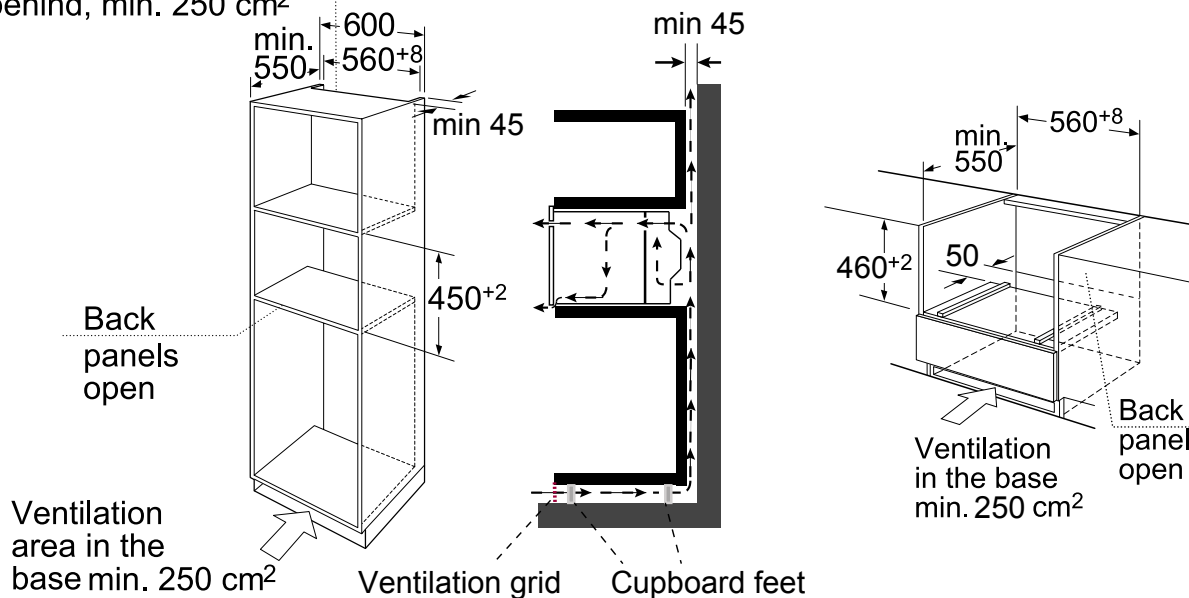

Note: There should be gap above the oven.



Building in

- Do not hold or carry the appliance by the door handle. The door handle cannot hold the weight of the appliance and may break off.
1. Carefully push the microwave into the box, making sure that it is in the centre.
 2. Open the door and fasten the microwave with the screws that were supplied.

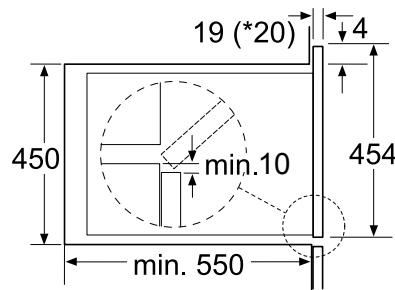
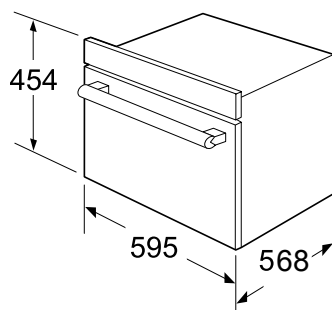

* 20 mm for metal fascias

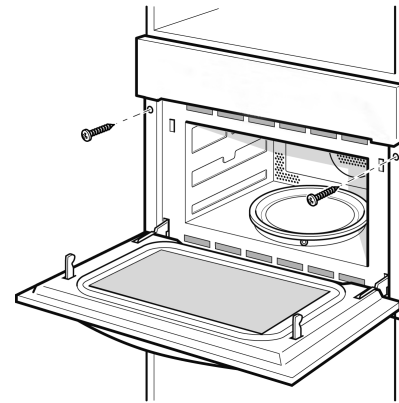

- Fully insert the appliance and centre it.
- Do not kink the connecting cable.
- Screw the appliance into place.
- The gap between the worktop and the appliance must not be closed by additional battens.

Important information

The appliance is designed to be permanently installed with a three-pin power cord and may only be connected by a licensed expert in accordance with the connection diagram.

Only a qualified electrician who takes the relevant regulations into account may replace the power cord.

Do not use multiple plugs, power strips or extensions. Overloading causes a risk of fire.

If the connection is no longer accessible following installation, an all-pin isolating switch with a contact gap of at least 3 mm must be provided.

Connect the wires of the mains power cord in accordance with the following colour coding:

Green and yellow Earth wire (⊕) (E)

Blue Neutral wire (N)

Brown Live (L)

Great Britain and Australia:

Do not connect the appliance using a 13 A plug or protect it with a 13 A fuse. The appliance must be protected using a fuse that is rated 16 A or higher. The appliance must be disconnected from the power supply during all installation work. When the appliance is installed, protection must be provided against accidental contact in the future.

Your new appliance

Use this section to familiarise yourself with your new appliance. The control panel and the individual operating controls are

explained. You will find information on the cooking compartment and the accessories.

Control panel



Touch keys and display

The touch keys are used to set the various additional functions. On the display, you can read the values that you have set.

Symbol	Function
	Microwave
	Heating
	Combination
	Parameter adjustment
	Parameter switch
	Clock
	Touch and hold:Childproof Lock Touch briefly:Stop Touch twice:Cancel
	Start
	Auto-programs
	Defrost
	Touch briefly:Rapid preheating

Function and screen display

Use the function keys to set the type of heating.

Function	Use
3D Hot air	For baking sponge cakes in baking tins, flans and cheesecakes as well as cakes, pizza and small baked items on the baking tray.50°C can maintain the taste of food after heat preservation of 1-2 hours.
Grill with fan	Poultry goes brown and crispy. Baked casseroles and grilled dishes work out best using this setting.
Pizza setting	For frozen convenience products and dishes which require a lot of heat from underneath.
Grill	Select between the levels high, medium or low. This is ideal if you wish to grill several steaks, sausages, pieces of fish or slices of bread.
Microwave+Hot air	Use this function to roast meals quickly. And at the same time use the function of 3D Hot air
Microwave+Grill Fan	Poultry goes brown and crispy. Baked casseroles and grilled dishes work out best using this setting.And use the function to roast meals evenly.
Microwave+Pizza	Use this function to roast meals quickly. And at the same time use the function of Pizza setting.

Function	Use
Microwave+Grill	Use this function to cook meals quickly and at the same time give the meal a brown crust.
Defrost	2 defrosting programmes
Auto-programs	13 cooking programmes The type of heating and cooking time are set by weight except d03.
Microwave	Defrost,reheat and cooking.

Parameter adjustment

Use the adjusting keys to set the parameters.

parameter	function
Auto menu	Select 13 automatic programmes. From P 01 to P 13.
Temperature	Select the temperature of cooking(°C). : 50,100,105,110...230 : 100,105,110...230 : 100,105,110...230 + : 50,100,105,110...230 + : 100,105,110...230 + : 100,105,110...230
Weight	Set the weight of cooking.
Time	Set the time of cooking.
Microwave	Select microwave power.100W,300W 450W,700W and 900W

Cooling fan

Your appliance has a cooling fan. The cooling fan switches on during operation. The hot air escapes above the door.

The cooling fan continues to run for a certain time after operation.

Caution!

Do not cover the ventilation slots. Otherwise, the appliance will overheat.

Notes

- The appliance remains cool during microwave operation. The cooling fan will still switch on. The fan may run on even when microwave operation has ended.
- Condensation may appear on the door window, interior walls and floor. This is normal and does not adversely affect microwave operation. Wipe away the condensation after cooking.

Accessories

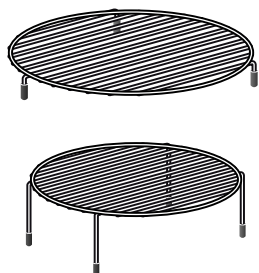
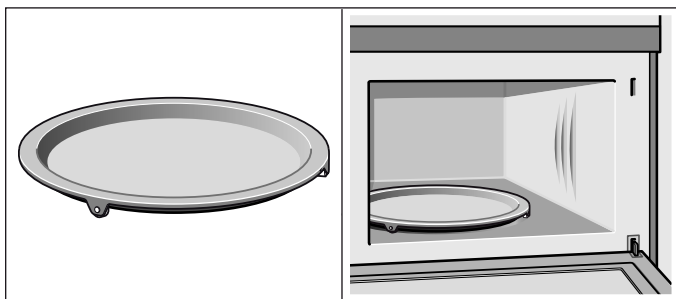

Turntable

As a surface for the wire rack.
Food which particularly requires a lot of heat from underneath can be prepared directly on the turntable.

The turntable can turn clockwise or anti-clockwise.
Place the turntable on the drive in the centre of the cooking compartment. Ensure that it is properly fitted.

- Never use the microwave without the turntable.
- The turntable can withstand max. 5 kg.
- The turntable must turn when using all types of heating.

Lower wire rack

For the microwave and for baking and roasting in the oven.

Higher wire rack

For grilling, e.g. steaks, sausages and for toasting bread.

As a support for shallow dishes.

Note:

Type and quantity of accessories is subject to actual demand.

Before using the appliance for the first time

Here you will find everything you need to do before using your oven to prepare food for the first time. First read the section on *Safety information*.

Setting the clock

Once the appliance is connected, "00:00" will blink, buzzer will ring once. Set the clock.

1. Touch " < > " key
between 00:00 and 23:59
2. Touch the ⌚ key.
The time is set.

Heating up the oven

To remove the new cooker smell, heat up the oven when it is empty and closed. One hour with ☀ Hot air at 230 °C is ideal. Ensure that no packaging remnants have been left in the cooking compartment.

1. Touch the ☀ heating key to set ☀ Hot air.
2. Touch the ☀ key and then touch " < > " key to set the temperature to 230 °C.
3. Touch the ⌚ key. Touch " < > " key to set the cooking time to 60 minutes.
4. Touch the ▶ key. The oven begins to heat up.

Cleaning the accessories

Before you use the accessories for the first time, clean them thoroughly with hot soapy water and a soft dish cloth.

Setting the oven

There are various ways in which you can set your oven. Here we will explain how you can select the desired type of heating and temperature or grill setting. You can also select the oven cooking time for your dish. Please refer to the section on *Setting the time-setting options*.

Setting the type of heating and temperature

Example : ☀ Hot air at 200 °C for 25 minutes.

1. Touch the ☀ heating key to set ☀ Hot air.
2. The default temperature 180 °C will light. Touch the ☀ key.
Touch " < > " key to set the temperature to 200 °C.
3. Touch the ⌚ key. Touch " < > " key to set the cooking time to 25 minutes.
4. Touch the ▶ key. The oven begins to heat up.

Opening the oven door during operation

Operation is suspended. After closing the door, touch the ▶ key. Operation continues.

Pausing operation

Touch the ⏸ key to pause operation. Then touch the ▶ key to continue operation.

Changing the cooking time

This can be done at any time. Touch the ⌚ key. Touch " < > " key to change the cooking time.

Changing the temperature

This can be done at any time.
Touch the ☀ for the new temperature setting. Touch " < > " key to set the temperature.

Cancelling operation

Touch the ⏸ key twice to cancel operation.

Rapid Preheating

With rapid preheating, your oven reaches the set temperature particularly quickly.

Rapid Preheating is available for the following types of heating:

- 3D Hot air
- Grill with fan
- Microwave+Hot air
- Microwave+Grill Fan
- Pizza setting
- Microwave+Pizza

To ensure an oven cooking result, only put your food in the cooking compartment when the preheating phase is complete.

1. Setting the type of heating and temperature.
2. Touch the key.
The symbol lights up in the display.
3. Touch the key.

The oven begins to heat up.

The preheating process is complete

A signal sounds. The symbol in the display blinks. Put your dish in the oven.

Cancelling rapid preheating

During setting the rapid preheating function, touch the can cancel the function.

During rapid preheating, touch the or can cancel the function. Also you can open the door to cancel the function.

- Note:**
1. The rapid preheating function only works if you have already chosen one of the modes above. During preheating, the microwave function is switched off.
 2. Only when you can hear alarm and preheating icon is blinking you can open the door and put food inside.

The microwave

Microwaves are converted to heat in foodstuffs. The microwave can be used solo, i.e. on its own, or in combination with a different type of heating. You will find information about ovenware and how to set the microwave.

Note:

In the Expert Cooking Guide, you will find examples for defrosting, heating and cooking with the microwave oven.

Note:

The step quantities for the adjustment time of the coding switch are as follow:

- 0-1 min : 1second
- 1-5 min : 10seconds
- 5-15 min : 30seconds
- 15-60 min : 1minute
- 60 min : 5minutes

Notes regarding ovenware

Suitable ovenware

Suitable dishes are heat-resistant ovenware made of glass, glass ceramic, porcelain, ceramic or heat-resistant plastic. These materials allow microwaves to pass through.

You can also use serving dishes. This saves you having to transfer food from one dish to another. You should only use ovenware with decorative gold or silver trim if the manufacturer guarantees that they are suitable for use in microwaves.

Unsuitable ovenware

Metal ovenware is unsuitable. Metal does not allow microwaves to pass through. Food in covered metal containers will remain cold.

Caution!

Creation of sparks: metal – e.g. a spoon in a glass – must be kept at least 2 cm from the oven walls and the inside of the door. Sparks could destroy the glass on the inside of the door.

Ovenware test

Do not switch on the microwave unless there is food inside. The following ovenware test is the only exception to this rule.

Perform the following test if you are unsure whether your ovenware is suitable for use in the microwave:

1. Heat the empty ovenware at maximum power for ½ to 1 minute.
2. Check the temperature occasionally during that time.

The ovenware should still be cold or warm to the touch.

The ovenware is unsuitable if it becomes hot or sparks are generated.

Microwave power settings

Use the key to set the desired microwave power.





100W	-Defrosting sensitive/delicate foods -Defrosting irregularly-shaped foods -Softening ice cream -Allowing dough to rise
300 W	-Defrosting -Melting chocolate and butter
450 W	-cooking rise , soup
700 W	-Reheating -cooking mushrooms, shell fish -cooking dishes containing eggs and cheese
900 W	-Boiling water, reheating -cooking chicken, fish, vegetables

Notes

- When you touch a key, the selected power lights up.
- The microwave power can be set to 900 watts for a maximum of 30 minutes. With all other power settings a maximum cooking time of 1 hour 30 minutes is possible.

Setting the microwave

Example: Microwave power setting 300 W, cooking time 17 minutes

1. Touch the  microwave key. The default microwave power 900W will blink and the default cooking time will appear.
2. Touch the  key, the default cooking time will blink. Touch " < > " key to adjust the cooking time to 17 minutes
3. Touch the  key. Touch " < > " key to adjust the microwave power to 300W.
4. Touch the  key.

Operation begins. The cooking time starts counting down in the display.

The cooking time has elapsed

A signal sounds. Microwave operation has finished.

Opening the oven door during operation

Operation is suspended. After closing the door, touch the  key. Operation continues.

Changing the cooking time



This can be done at any time. Touch the  key. Touch " < > " key to change the cooking time.

Changing the microwave power setting

This can be done at any time.

Touch the  for the new microwave power setting. Touch " < > " key to set the microwave power.

Pausing operation

Touch the  key briefly. The oven is paused. Touch the  key again to continue operation.

Cancelling operation

Touch the  key twice to cancel operation.

Notes

- When you touch the  microwave key, the highest microwave power setting always lights up as the suggested setting.
- If you open the appliance door during cooking, the fan may continue to run.







MicroCombi operation

This involves simultaneous operation of the grill and the microwave. Using the microwave makes your dishes ready more quickly, but they are still nicely browned.

You can switch on all microwave power settings. Exception: 900 watts

Setting Microwave Combi operation

Example: microwave 100 W, 17 minutes and hot air  190 °C.

1. Touch the  combination key to set  + .
2. The default temperature 180°C will light. Touch the  key. Touch " < > " key to set the temperature to 190 °C.
3. The default microwave power is 300W. Touch the  key again and then touch " < > " key to set the microwave power to 100W.
4. Touch the  key. Touch " < > "key to set the cooking time to 17 minutes.
5. Touch the  key.

Appliance operation begins. The cooking time starts counting down.



The cooking time has elapsed

A signal sounds. Combination mode has finished.

Opening the oven door during cooking

Operation is suspended. After closing the door, touch the  key briefly. The programme will then continue.

Pausing operation

Touch the  key briefly. The oven is paused. Touch the  key again to continue operation.

Changing the cooking time

This can be done at any time. Touch the  key. Touch " < > " key to change the cooking time.

Changing the microwave power setting

This can be done at any time.

Touch the  for the new microwave power setting. Touch " < > "key to set the microwave power.

Changing the temperature

This can be done at any time.

Touch the  for the new temperature setting. Touch " < > "key to set the temperature.

Cancelling operation

Touch the  key twice to cancel operation.

Automatic programmes

The automatic programmes enable you to prepare food very easily. You select the programme and enter the weight of your food. The automatic programme makes the optimum setting. You can choose from 13 programmes.

Always place the food in the cold cooking compartment.



Setting a programme

When you have selected a programme, set the oven. The temperature selector must be in the off position.

Example : Programme 3 with a weight of 1 kilogramme.

1. Touch the  key.

The first programme number appears in the display.

2. Touch " < > " or  key to select the programme number P03.
3. Touch the  key.
4. Touch " < > " key to set the weight, cooking time will shown.
5. Touch the  key. The programme starts. You can see the cooking time counting down .

Auto Menu

Programme no.	Category	Item
P 01**	Vegetables	Fresh vegetables
P 02**	Side dishes	Potatoes-peeled/cooked
P 03*	Side dishes	Potatoes-roasted
P 04	Poultry/Fish	Chicken pieces
P 05*	Bakery	Cake
P 06*	Bakery	Apple pie
P 07*	Bakery	quiche
P 08**	Reheat	Drink/soup
P 09**	Reheat	Plated meal
P 10**	Reheat	Sauce/stew/dish
P 11*	Convenience	Frozen-Pizza
P 12*	Convenience	Frozen-Oven chips
P 13*	Convenience	Frozen-Lasagna

Notes

- The programmes with a * are preheated. During preheating, the cooking time pauses and the preheating symbol is on. After preheating, you will hear an alarm and the preheating symbol will blink.
- The programmes with ** only use the microwave function.
- The food of P03, P04, P05, P06, P07, P11, P12 and P13 should be placed on the 60mm high wire rack to cook.

Programme has ended

A signal sounds. The oven stops heating.

Changing the programme

Once you have started the programme, the programme number and weight cannot be changed.

Cancelling the programme



Touch the  key twice to cancel operation.

Changing the cooking time

If using automatic programmes, you cannot change the cooking time .

Defrosting programmes

You can use the 2 defrosting programmes to defrost meat, poultry and bread.

1. Touch the  key.
The first programme number appears in the display.
2. Touch " < > " to select the programme number.
3. Touch the  key.
4. Touch " < > " key to set the weight.
5. Touch the  key. The programme starts. You can see the cooking time counting down .

Notes

- **Preparing food**
Use food that has been frozen at -18 °C and stored in portion-sized quantities that are as thin as possible.
Take the food to be defrosted out of all packaging and weigh it. You need to know the weight to set the programme.
- Liquid will be produced when defrosting meat or poultry. Drain off this liquid when turning meat and poultry and under no circumstances use it for other purposes or allow it to come into contact with other foods.
- **Ovenware**
Place the food in a microwaveable shallow dish, e.g. a china or glass plate, but do not cover.
- When defrosting chicken and chicken portions (d 01), an audible signal will sound on two occasions to indicate that the food should be turned.
- **Resting time**
The defrosted food should be left to stand for an additional 10 to 30 minutes until it reaches an even temperature. Large pieces of meat require a longer standing time than smaller pieces. Flat pieces of meat and items made from minced meat should be separated from each other before leaving to stand.
After this time, you can continue to prepare the food, even though thick pieces of meat may still be frozen in the middle. The giblets can be removed from poultry at this point.

Programme no.	Defrost	Weight range in kg
d 01*	meat, poultry and fish	0.20 - 1.00
d 02*	bread, cake and fruit	0.10 - 0.50

*During defrosting, place the food on the Lower wire rack

*If you hear a beep, turn the food.

Then touch start key to continue defrost.

Setting the time-setting options

Your oven has various time-setting options. You can use the  key to call up the menu and switch between the individual functions. A time-setting option that has already been set can be changed directly with the " < > " key.

Setting the cooking time

The cooking time for your meal can be set on the oven. When the cooking time has elapsed, the oven switches itself off automatically. This means that you do not have to interrupt other work to switch off the oven. The cooking time cannot be accidentally exceeded.

The oven starts. The cooking time counts down in the display.

The cooking time has elapsed



An audible signal sounds. The oven stops heating.

Setting the clock

Once the appliance is connected, "00:00" will blink, buzzer will ring once. Set the clock.

1. Touch " < > " key
between 00:00 and 23:59
2. Touch the  key.
The time is set.

Changing the clock

1. Touch and hold the  key for 3 seconds in waiting state.
The actual time disappear and then the time will blink in the display.
2. Touch " < > " key to set the new time and touch the  key to confirm the setting.

Childproof lock

The oven has a childproof lock to prevent children switching it on accidentally.

The oven will not react to any settings. The timer and clock can also be set when the childproof lock has been switched on.

Switching on the childproof lock

Requirement: No cooking time should be set .

Touch and hold the  key for approx. 3 seconds.

The  symbol appears in the display. The childproof lock is activated.

Switching off the childproof lock

Touch and hold the  key for approx. 3 seconds.

The  symbol on the display goes out. The childproof lock is deactivated.

Childproof lock with other cooking operations

When other cooking programmes have been set, the childproof lock is not operational.

Care and cleaning

With careful care and cleaning your microwave oven will retain its looks and remain good order. We will explain here how you should care for and clean your appliance correctly.

⚠ Risk of electric shock.!

Penetrating moisture may cause an electric shock. Do not use any high-pressure cleaners or steam cleaners.

⚠ Risk of burns!

Never clean the appliance immediately after switching off. Let the appliance cool down.

⚠ Risk of serious damage to health!

Microwave energy may escape if the cooking compartment door or the door seal is damaged. Never use the appliance if the cooking compartment door or the door seal is damaged. Contact the after-sales service.

Notes

- Slight differences in colour on the front of the appliance are caused by the use of different materials, such as glass, plastic and metal.
- Shadows on the door panel which look like streaks, are caused by reflections made by the oven light.
- Unpleasant odours, e.g. after fish has been prepared, can be removed very easily. Add a few drops of lemon juice to a cup of water. Place a spoon into the container as well, to prevent delayed boiling. Heat the water for 1 to 2 minutes at maximum microwave power.

Cleaning agents

To ensure that the different surfaces are not damaged by using the wrong cleaning agent, observe the information in the table. Do not use

- sharp or abrasive cleaning agents,
- metal or glass scrapers to clean the glass in the appliance door.
- metal or glass scrapers to clean the door seal,
- hard scouring pads and sponges,
- cleaning agents with high concentrations of alcohol.

Wash new sponge cloths thoroughly before use.

Allow all surfaces to dry thoroughly before using the appliance again.

Area	Cleaning agents
Appliance front	Hot soapy water: Clean with a dish cloth and dry with a soft cloth. Do not use glass cleaners or metal or glass scrapers for cleaning.
Appliance front with stainless steel	Hot soapy water: Clean with a dish cloth and dry with a soft cloth. Remove flecks of limescale, grease, starch and albumin (e.g. egg white) immediately. Corrosion can form under such residues. Special stainless steel cleaning agents can be obtained from the after-sales service or from specialist shops. Do not use glass cleaners or metal or glass scrapers for cleaning.
Cooking compartment	Hot soapy water or a vinegar solution: Clean with a dish cloth and dry with a soft cloth. If the oven is very dirty: Do not use oven spray or other aggressive oven cleaners or abrasive materials. Scouring pads, rough sponges and pan cleaners are also unsuitable. These items scratch the surface. Allow the interior surfaces to dry thoroughly.
Recess in cooking compartment	Damp cloth: Ensure that no water seeps through the turntable drive into the appliance interior.
Wire racks	Hot soapy water: Clean using stainless steel cleaning agent or in the dishwasher.
Door panels	Glass cleaner: Clean with a dish cloth. Do not use a glass scraper.
Seal	Hot soapy water: Clean with a dish cloth, do not scour. Do not use a metal or glass scraper for cleaning.

Technical data

Rated Voltage	230-240 V ~ 50 Hz
Maximum Power	3350W
Rated Output Power(Microwave)	900W
Rated Current	15A
Oven Capacity	44L
Turntable Diameter	∅ 360mm
External Dimensions Without handle	595(W) × 568(D) × 454(H)mm
Net Weight	Approx. 36kg

Malfunction table







Malfunctions often have simple explanations. Please refer to the malfunction table before calling the after-sales service.

If a meal does not turn out exactly as you wanted, refer to the Expert Cooking Guide section, where you will find plenty of cooking tips and tricks.

Risk of electric shock!

Incorrect repairs are dangerous. Repairs may only be carried out by one of our trained after-sales engineers.

Malfunction table

Problem	Possible cause	Remedy/information
The appliance does not work.	Faulty circuit breaker.	Look in the fuse box and check that the circuit breaker for the appliance is in working order.
	Plug not plugged in.	Plug in the plug.
	Power cut	Check whether the kitchen light works.
The appliance does not work.  appears in the display panel.	Childproof lock is active.	Deactivate the childproof lock (see section: Childproof lock).
 is in the display panel.	Power cut	Reset the clock.
The microwave does not switch on.	Door not fully closed.	Check whether food residue or debris is trapped in the door.
It takes longer than before for the food to heat up in the microwave	The selected microwave power level is too low.	Select a higher power level.
	A larger amount than usual has been placed in the appliance.	Double the amount = almost double the cooking time.
	The food was colder than usual.	Stir or turn the food during cooking.
Turntable grates or grinds.	Dirt or debris in the area around the turntable drive.	Clean the rollers under the turntable and the recess in the oven floor thoroughly.
A particular operating mode or power level cannot be set.	The temperature, power level or combined setting is not possible for this operating mode.	Choose permitted settings.
 appears in the display panel.	The thermal safety switch-off function has been activated.	Call the after-sales service.
 appears in the display panel.	The thermal safety switch-off function has been activated.	Call the after-sales service.
 appears in the display panel.	Moisture in the control panel.	Allow the control panel to dry.
 appears in the display panel.	Rapid heating has failed.	Call the after-sales service.

Acrylamide in foodstuffs

Which foods are affected?

Acrylamide is mainly produced in grain and potato products that are heated to high temperatures, such as potato crisps, chips,

toast, bread rolls, bread, fine baked goods (biscuits, gingerbread, cookies).

Tips for keeping acrylamide to a minimum when preparing food

General	Keep cooking times to a minimum. Cook meals until they are golden brown, but not too dark. Large, thick pieces of food contain less acrylamide.
Baking biscuits Oven chips	Max. 200 °C in Top/bottom heating or max. 180 °C in 3D hot air or hot air mode. Max. 190 °C in Top/bottom heating or max. 170 °C in 3D hot air or hot air mode. Egg white and egg yolk reduce the formation of acrylamide. Distribute thinly and evenly over the baking tray. Cook at least 400 g at once on a baking tray so that the chips do not dry out.

Energy and environment tips

Here you can find tips on how to save energy when baking and roasting and how to dispose of your appliance properly.

Saving energy

- Only preheat the oven if this is specified in the recipe or in the operating instruction tables.
- Use dark, black lacquered or enamelled baking tins. They absorb the heat particularly well.
- Open the oven door as infrequently as possible while you are cooking, baking or roasting.
- It is best to bake several cakes one after the other. The oven is still warm. This reduces the baking time for the second cake. You can also place two loaf tins next to each other.

- For longer cooking times, you can switch the oven off 10 minutes before the end of the cooking time and use the residual heat to finish cooking.

Environmentally-friendly disposal

Dispose of packaging in an environmentally-friendly manner.



This appliance complies with European Directive 2002/96/EC on Waste Electrical and Electronic Equipment (WEEE). The directive gives a framework for the collection and recycling of old appliances, which is valid across the EU.

Expert Cooking Guide

Here you will find a selection of recipes and the ideal settings for them. We will show you which type of heating and which temperature or microwave power setting is best for your meal. You can find information about suitable accessories and the height at which they should be inserted. There are also tips about ovenware and preparation methods.

Notes

- The values in the table always apply to food placed into the cooking compartment when it is cold and empty. Only preheat the appliance if the table specifies that you should do so. Before using the appliance, remove all accessories from the cooking compartment that you will not be using.
- Do not line the accessories with greaseproof paper until after they have been preheated.
- The times specified in the tables are only guidelines. They will depend on the quality and composition of the food.
- Use the accessories supplied. Additional accessories may be obtained from specialist retailers or from the after-sales service.
- Always use an oven cloth or oven gloves when taking accessories or ovenware out of the cooking compartment.

Defrosting, heating up and cooking with the microwave

The following tables provide you with numerous options and settings for the microwave.

Defrost	Weight	Microwave power setting in watts, cooking time in minutes	Notes
Whole pieces of meat (beef, veal or pork - on the bone or boned)	800 g	300 W, 15 mins + 100 W, 10-20 mins	Turn several times
	1 kg	300 W, 20 mins + 100 W, 15-25 mins	
	1.5 kg	300 W, 30 mins + 100 W, 20-30 mins	
Meat in pieces or slices of beef, veal or pork	200 g	300 W, 3 mins + 100 W, 10-15 mins	Separate any defrosted parts when turning
	500 g	300 W, 5 mins + 100 W, 15-20 mins	
	800 g	300 W, 8 mins + 100 W, 15-20 mins	
Minced meat, mixed	200 g	100 W, 10-15 mins	Freeze food flat if possible Turn several times, remove any defrosted meat
	500 g	300 W, 5 mins + 100 W, 10-15 mins	
	800 g	300 W, 8 mins + 100 W, 15-20 mins	
Poultry or poultry portions	600 g	300 W, 8 mins + 100 W, 10-15 mins	Turn during cooking.
	1.2 kg	300 W, 15 mins + 100 W, 25-30 mins	
Duck	2 kg	300 W, 20 mins + 100 W, 30-40 mins	Turn several times

The times specified in the tables are only guidelines. They may vary according to the ovenware used, the quality, temperature and consistency of the food.

Time ranges are often specified in the tables. Set the shortest time first and then extend the time if necessary.

It may be that you have different quantities from those specified in the tables. A rule of thumb can be applied: Double amount - just under double the cooking time, half amount - half the cooking time.

Defrosting

Notes

- Place the frozen food in an open container on the lower wire rack.
- Delicate parts such as the legs and wings of chicken or fatty outer layers of roasts can be covered with small pieces of aluminium foil. The foil must not touch the cooking compartment walls. You can remove the foil half way through the defrosting time.
- Turn or stir the food once or twice during the defrosting time. Large pieces of food should be turned several times. When turning, remove any liquid that has resulted from defrosting.
- Leave defrosted items to stand at room temperature for a further 10 to 60 minutes so that the temperature can stabilise. The giblets can be removed from poultry at this point.

Defrost	Weight	Microwave power setting in watts, cooking time in minutes	Notes
Fish fillet, fish steak or slices	400 g	300 W, 5 mins + 100 W, 10-15 mins	Separate any defrosted parts
Whole fish	300 g	300 W, 3 mins + 100 W, 10-15 mins	-
	600 g	300 W, 8 mins + 100 W, 10-15 mins	
Vegetables, e.g. peas	300 g	300 W, 10-15 mins	Stir carefully during defrosting.
	600 g	300 W, 10 mins + 100 W, 10-15 mins	
Fruit, e.g. raspberries	300 g	300 W, 7-10 mins	Stir carefully during defrosting and separate any defrosted parts
	500 g	300 W, 8 mins + 100 W, 5-10 mins	
Butter, defrosting	125 g	300 W, 1 mins + 100 W, 2-4 mins	Remove all packaging
	250 g	300 W, 1 min + 100 W, 2-4 mins	
Loaf of bread	500 g	300 W, 6 mins + 100 W, 5-10 mins	Turn during cooking.
	1 kg	300 W, 12 mins + 100 W, 15-25 mins	
Cakes, dry, e.g. sponge cake	500 g	100 W, 15-20 mins	Only for cakes without icing, cream or crème pâtissière, separate the pieces of cake.
	750 g	300 W, 5 mins + 100 W, 10-15 mins	
Cakes, moist, e.g. fruit flan, cheesecake	500 g	300 W, 5 mins + 100 W, 10-15 mins	Only for cakes without icing, cream or gelatine
	750 g	300 W, 7 mins + 100 W, 10-15 mins	

- Place the food directly on the turntable.

Defrosting, heating up or cooking frozen food

Notes

- Take ready meals out of the packaging. They will heat up more quickly and evenly in microwaveable ovenware. The different components of the meal may not require the same amount of time to heat up.
- Food which lies flat will cook more quickly than food which is piled high. You should therefore distribute the food so that it is as flat as possible in the ovenware. Different foodstuffs should not be placed in layers on top of one another.

- Always cover the food. If you do not have a suitable cover for your ovenware, use a plate or special microwave foil.
- Stir or turn the food 2 or 3 times during cooking.
- After heating, allow the food to stand for a further 2 to 5 minutes so that it can achieve an even temperature.
- Always use an oven cloth or oven gloves when removing plates from the oven.
- This will help the food retain its own distinct taste, so it will require less seasoning.

Defrosting, heating up or cooking frozen food	Weight	Microwave power setting in watts, cooking time in minutes	Notes
Menu, plated meal, ready meal	300-400 g	700 W, 10-15 mins	Take meal out of packaging; cover food to heat
Soup	400-500 g	700 W, 8-10 mins	Ovenware with lid
Stews	500 g	700 W, 10-15 mins	Ovenware with lid
	1 kg	700 W, 20-25 mins	
Slices or pieces of meat in sauce, e.g. goulash	500 g	700 W, 15-20 mins	Ovenware with lid
	1 kg	700 W, 25-30 mins	
Fish, e.g. fillet steaks	400 g	700 W, 10-15 mins	Covered
	800 g	700 W, 18-20 mins	
Side dishes, e.g. rice, pasta	250 g	700 W, 2-5 mins	Ovenware with lid; add liquid
	500 g	700 W, 8-10 mins	
Vegetables, e.g. peas, broccoli, carrots	300 g	700 W, 8-10 mins	Ovenware with lid; add 1 tbsp of water
	600 g	700 W, 15-20 mins	
Creamed spinach	450 g	700 W, 11-16 mins	Cook without additional water

Heating food

Risk of scalding!

There is a possibility of delayed boiling when a liquid is heated. This means that the liquid reaches boiling temperature without the usual steam bubbles rising to the surface. Even if the container only moves a little, the hot liquid can suddenly boil over and spatter. When heating liquids, always place a spoon in the container. This will prevent delayed boiling.

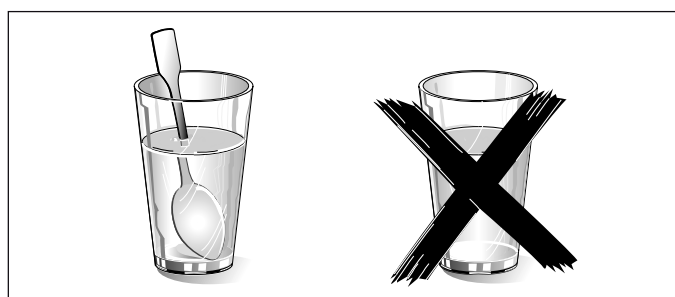

Caution!

Metal - e.g. a spoon in a glass - must be kept at least 2 cm from the oven walls and the inside of the door. Sparks could irreparably damage the glass on the inside of the door.

Notes

- Take ready meals out of the packaging. They will heat up more quickly and evenly in microwaveable ovenware. The different components of the meal may not require the same amount of time to heat up .

- Always cover the food. If you do not have a suitable cover for your container, use a plate or special microwave foil.
- Stir or turn the food several times during the heating time. Check the temperature.
- After heating, allow the food to stand for a further 2 to 5 minutes so that it can achieve an even temperature.
- Always use an oven cloth or oven gloves when removing plates from the oven.
- Place the food directly on the turntable.

Heating food	Weight	Microwave power setting in watts, cooking time in minutes	Notes
Menu, plated meal, ready meal	350-500 g	700 W, 5-10 mins	Take meal out of packaging, cover food to heat
Drinks	150 ml	900 W, 1-2 mins	Caution! Place a spoon in the glass. Do not overheat alcoholic drinks. Check during heating
	300 ml	900 W, 2-3 mins	
	500 ml	900 W, 3-4 mins	
Baby food, e.g. baby bottle	50 ml	300 W, approx. 1 min	Place baby bottles on the cooking compartment floor without the teat or lid. Shake or stir well after heating. You must check the temperature
	100 ml	300 W, 1-2 mins	
	200 ml	300 W, 2-3 mins	
Soup			-
1 cup	175 g	900 W, 2-3 mins	
2 cups	175 g each	900 W, 4-5 mins	
4 cups	175 g each	900 W, 5-6 mins	
Slices or pieces of meat in sauce, e.g. goulash	500 g	700 W, 10-15 mins	Covered
Stew	400 g	700 W, 5-10 mins	Ovenware with lid
	800 g	700 W, 10-15 mins	
Vegetables	150 g	700 W, 2-3 mins	Add a little liquid
	300 g	700 W, 3-5 mins	

Cooking food**Notes**

- Food which lies flat will cook more quickly than food which is piled high. You should therefore distribute the food so that it is as flat as possible in the ovenware. Different foodstuffs should not be placed in layers on top of one another.
- Place the food directly on the turntable.

- Cook the food in ovenware with a lid. If you do not have a suitable lid for your ovenware, use a plate or special microwave foil.
- This will help the food retain its own distinct taste, so it will require less seasoning.
- After cooking, allow the food to stand for a further 2 to 5 minutes so that it can achieve an even temperature.
- Always use an oven cloth or oven gloves when removing plates from the oven.

Cooking food	Weight	Microwave power in watts, Cooking time in minutes	Notes
Whole chicken, fresh, no giblets	1.5 kg	700 W, 30-35 mins	Turn halfway through the cooking time
Fish fillet, fresh	400 g	700 W, 5-10 mins	-
Fresh vegetables	250 g	700 W, 5-10 mins	Cut into equal-sized pieces; add 1 to 2 tbsp water per 100 g; stir during cooking
	500 g	700 W, 10-15 mins	
Potatoes	250 g	700 W, 8-10 mins	Cut into equal-sized pieces; add 1 to 2 tbsp water per 100 g; stir during cooking
	500 g	700 W, 11-14 mins	
	750 g	700 W, 15-22 mins	
Rice	125 g	700 W, 7-9 mins+ 300 W, 15-20 mins	Add double the quantity of liquid and use deep ovenware with a lid
	250 g	700 W, 10-12 mins + 300 W, 20-25 mins	
Sweet foods, e.g. blancmange (instant)	500 ml	700 W, 7-9 mins	Stir 2 to 3 times with an egg whisk while heating
Fruit, compote	500 g	700 W, 9-12 mins	-

Popcorn for the microwave

Notes

- Use heat-resistant, flat glass ovenware, e.g. the lid of an ovenproof dish, a glass plate or a glass tray (Pyrex)
- Always place the ovenware on the wire rack.
- Do not use porcelain or overly curved plates.

- Make the settings as described in the table. You can adjust the timings according to product and amount.
- So that the popcorn doesn't burn, briefly take the popcorn bag out of the oven after 1 minute and 30 seconds and shake it. Take care as the bag will be hot!

Risk of scalding!

- Open the popcorn bag carefully as hot steam may be released.
- Never set the microwave to full power.

	Weight	Accessories	Microwave power in watts, Cooking time in minutes
Popcorn for the microwave	1 bag, 100 g	Ovenware	700 W, 3-5 mins

Microwave tips

You cannot find any information about the settings for the quantity of food you have prepared.

Increase or reduce the cooking times using the following rule of thumb:

Double the amount = almost double the cooking time

Half the amount = half the cooking time

The food has become too dry.

Next time, set a shorter cooking time or select a lower microwave power setting. Cover the food and add more liquid.

When the time has elapsed, the food is not defrosted, hot or cooked.

Set a longer time. Large quantities and food which is piled high require longer times.

When the time has elapsed, the food is overheated at the edge but not done in the middle.

Stir it during the cooking time and next time, select a lower microwave power setting and a longer cooking time.

After defrosting, the poultry or meat is defrosted on the outside but not defrosted in the middle.

Next time, select a lower microwave power setting. If you are defrosting a large quantity, turn it several times.

Cakes and pastries

About the tables

Notes

- The times given apply to food placed in a cold oven.
- The temperature and baking time depend on the consistency and amount of the mixture. This is why temperature ranges are given in the tables. Begin with the lower temperature and, if necessary, use a higher setting the next time, since a lower

temperature results in more even browning.

- Additional information can be found in the *Baking tips* section following the tables.
- **Always place the cake tin in the centre of the lower wire rack. But the food with ** should be placed in the turntable.**

Baking tins

Note: It is best to use dark-coloured metal baking tins.

Baking in tins	Accessories	Type of heating	Temperature °C	Microwave power in watts	Cooking time in minutes
Sponge cake, simple	Ring tin/cake tin	☉	170-180	100	40-50
Sponge cake, delicate (e.g. sandcake)*	Ring tin/cake tin	☉	150-170	-	70-90
Sponge flan base	Flan-base cake tin	☉	160-180	-	30-40
Delicate fruit flan, sponge	Springform/ring tin	☉	170-180	100	35-45
Sponge base, 2 eggs	Flan-base cake tin	☉	160-170	-	20-25
Sponge flan, 6 eggs	Dark springform cake tin	☉	170-180	-	35-45
Shortcrust pastry base with crust	Dark springform cake tin	☉	170-190	-	30-40
Fruit tart/cheesecake with pastry base*	Dark springform cake tin	☉	170-190	100	35-45
Swiss flan**	Dark springform cake tin	☉	190-200	-	45-55
Ring cake	Ring cake tin	☉	170-180	-	40-50
Pizza, thin base, light topping**	Round pizza tray	☉	220-230	-	15-25
Savoury cakes**	Dark springform cake tin	☉	200-220	-	50-60
Nut cake	Dark springform cake tin	☉	170-180	100	35-45
Yeast dough with dry topping	Round pizza tray	☉	160-180	-	50-60

* Allow cake to cool in the oven for approx. 20 minutes.

** the food should be placed in the turntable

Baking in tins	Accessories	Type of heating	Temperature °C	Microwave power in watts	Cooking time in minutes
Yeast dough with moist topping	Round pizza tray	☺	170-190	-	55-65
Plaited loaf with 500 g flour	Round pizza tray	☺	170-190	-	35-45
Stollen with 500 g flour	Round pizza tray	☺	160-180	-	60-70
Strudel, sweet	Round pizza tray	☺	190-210	100	35-45

* Allow cake to cool in the oven for approx. 20 minutes.

Small baked items	Accessories	Type of heating	Temperature in °C	Cooking time in minutes
Biscuits	Round pizza tray	☺	150-170	25-35
Macaroons	Round pizza tray	☺	110-130	35-45
Meringue	Round pizza tray	☺	100	80-100
Muffins	Muffin tray on wire rack	☺	160-180	35-40
Choux pastry	Round pizza tray	☺	200-220	35-45
Puff pastry	Round pizza tray	☺	190-200	35-45
Leavened cake	Round pizza tray	☺	200-220	25-35

Bread and bread rolls	Accessories	Type of heating	Temperature in °C	Cooking time in minutes
Sourdough bread with 1.2 kg flour	Round pizza tray	☺	210-230	50-60
Flatbread	Round pizza tray	☺	220-230	25-35
Bread rolls	Round pizza tray	☺	210-230	25-35
Rolls made with sweet yeast dough	Round pizza tray	☺	200-220	15-25

Baking tips

You want to bake according to your own recipe.	Use similar items in the baking tables as a guide.
Use baking tins made of silicone, glass, plastic or ceramic materials.	The baking tin must be heat-resistant up to 250 °C. Cakes in these baking tins will be less brown. When using the microwave, the cooking time will be shorter than the time shown in the table.
How to establish whether sponge cake is baked through.	Approximately 10 minutes before the end of the baking time specified in the recipe, poke the cake with a cocktail stick at its highest point. If the cocktail stick comes out clean, the cake is ready.
The cake collapses.	Use less liquid next time or set the oven temperature 10 degrees lower and extend the baking time. Observe the specified mixing times in the recipe.
The cake has risen in the middle but is lower around the edge.	Only grease the base of the springform cake tin. After baking, loosen the cake carefully with a knife.
The cake is too dark.	Select a lower temperature and bake the cake for a little longer.
The cake is too dry.	When it is done, make small holes in the cake using a toothpick. Then drizzle fruit juice or an alcoholic beverage over it. Next time, select a temperature 10 degrees higher and reduce the baking time.
The bread or cake (e.g. cheesecake) looks good, but is soggy on the inside (sticky, streaked with water).	Use slightly less fluid next time and bake for slightly longer at a lower temperature. When baking cakes with a moist topping, bake the base first, cover with almonds or bread crumbs and then add the topping. Please follow the recipe and follow the baking times.
The cake cannot be turned out of the dish when it is turned upside down.	After baking, allow the cake to cool for a further 5 to 10 minutes, then it will be easier to turn out of the tin. If it still sticks, carefully loosen the cake around the edges using a knife. Turn the cake tin upside down again and cover it several times with a cold, wet cloth. Next time, grease the tin well and sprinkle some bread crumbs into it.
You have measured the temperature of the oven using your own meat thermometer and found there is a discrepancy.	The oven temperature is measured by the manufacturer after a specified period of time using a test rack in the centre of the cooking compartment. Ovenware and accessories affect the temperature measurement, so there will always be some discrepancy when you measure the temperature yourself.
Sparks are generated between the tin and the wire rack.	Check that the tin is clean on the outside. Change the position of the tin in the cooking compartment. If this does not help, continue baking but without the microwave. The baking time will then be longer.

Roasting and grilling

About the tables

The temperature and roasting time depend on the type and amount of food being cooked. This is why temperature ranges are given in the tables. Begin with the lower temperature and, if necessary, use a higher setting the next time.

For more information, see the section entitled *Tips for grilling and roasting* which follows the tables.

Ovenware

You may use any heat-resistant ovenware which is suitable for use in a microwave. Metal roasting dishes are not suitable for roasting with microwaves.

The ovenware can become very hot. Use oven gloves to take the ovenware out of the oven.

Place hot glass ovenware on a dry kitchen towel after they have been removed from the oven. The glass could crack if placed on a cold or wet surface.

Tips for roasting

Notes

- Use a deep roasting dish for roasting meat and poultry.
- Check that your ovenware fits in the cooking compartment. It should not be too big.
- Meat:
Cover approx. two thirds of the ovenware base with liquid. Add slightly more liquid for pot roasts. Turn pieces of meat halfway through the cooking time. When the roast is ready, turn off the

oven and allow it to rest for an additional 10 minutes. This allows better distribution of the meat juices.

- Poultry:
Turn the pieces of meat after $\frac{2}{3}$ of the cooking time has elapsed.

Tips for grilling

Notes

- Always keep the oven door closed when grilling and do not preheat.
- As far as possible, the pieces of food you are grilling should be of equal thickness. Steaks should be at least 2 to 3 cm thick. This will allow them to brown evenly and remain succulent and juicy. Do not add salt to steaks until they have been grilled.
- Use tongs to turn the pieces of food you are grilling. If you pierce the meat with a fork, the juices will run out and it will become dry.
- Dark meat, e.g. beef, browns more quickly than lighter-coloured meat such as veal or pork. When grilling light-coloured meat or fish, these often only brown slightly on the surface, although they are cooked and juicy on the inside.
- The grill element switches off and on again automatically. This is normal. The grill setting determines how frequently this will happen.

Beef

Notes

- Turn pot-roasted beef after $\frac{1}{3}$ and $\frac{2}{3}$ of the cooking time. Finally, allow to stand for approx. a further 10 minutes.
- Turn tenderloins and sirloins halfway through the cooking time. Finally, allow to stand for approx. a further 10 minutes.
- Turn steaks after $\frac{2}{3}$ of the cooking time.

Beef	Accessories	Type of heating	Temperature in °C, grill setting	Microwave power in watts	Cooking time in minutes
Pot-roasted beef, approx. 1 kg*	Ovenware with lid	☺	180-200	-	120-143
Fillet of beef, medium, approx. 1 kg*	Ovenware without lid	☺	180-200	100	30-40
Sirloin, medium, approx. 1 kg*	Ovenware without lid	☺	210-230	100	30-40
Steak, medium, 3 cm thick**	Higher wire rack	—	3	-	each side: 10-15

* Lower wire rack

** Higher wire rack

Veal

Note: Turn joints and knuckle of veal halfway through the cooking time. Finally, allow to stand for approx. a further 10 minutes.

Veal	Accessories	Type of heating	Temperature °C	Microwave power in watts	Cooking time in minutes
Joint of veal, approx. 1 kg*	Ovenware with lid	☺	180-200	-	110-130
Knuckle of veal, approx. 1.5 kg*	Ovenware with lid	☺	200-220	-	120-130

* Lower wire rack

Pork

Notes

- Turn lean joints of pork and rindless joints halfway through the cooking time. Finally, allow to stand for approx. a further 10 minutes.
- Place the joint in the ovenware rind-side up. Score the rind. Do not turn the joint. Finally, allow to stand for approx. a further 10 minutes.
- Do not turn pork fillets or pork chops. Finally, allow to stand for approx. a further 5 minutes.
- Turn the neck of pork after $\frac{2}{3}$ of the cooking time.

Pork	Accessories	Type of heating	Temperature in °C, grill setting	Microwave power in watts	Cooking time in minutes
Joint without rind (e.g. neck), approx. 750 g*	Ovenware with lid	☉	220-230	100	40-50
Joint with rind (e.g. shoulder) approx. 1.5 kg*	Ovenware without lid	☉	190-210	-	130-150
Fillet of pork, approx. 500 g*	Ovenware with lid	☉	220-230	100	25-30
Joint of pork, lean, approx. 1 kg*	Ovenware with lid	☉	210-230	100	60-80
Smoked pork on the bone, approx. 1 kg*	Ovenware without lid	-	-	300	45-50
Neck of pork, 2 cm thick**	-	-	3	-	1st side: approx. 15-20 2nd side: approx. 10-15

* Lower wire rack
** Higher wire rack

Lamb

Note: Turn the leg of lamb halfway through the cooking time.

Lamb	Accessories	Type of heating	Temperature °C	Microwave power in watts	Cooking time in minutes
Saddle of lamb on the bone, approx. 1 kg*	Ovenware without lid	☉	210-230	-	40-50
Leg of lamb, boned, medium, approx. 1.5 kg*	Ovenware with lid	☉	190-210	-	90-95

* lower wire rack

Miscellaneous

Notes

- Finally, allow the meat loaf to stand for approx. a further 10 minutes.
- Turn the sausages after $\frac{2}{3}$ of the cooking time.

Miscellaneous	Accessories	Type of heating	Temperature in °C, grill setting	Microwave power in watts	Cooking time in minutes
Meat loaf, approx. 1 kg*	Ovenware without lid	☉	180-200	700 W + 1 00 W	-
4 to 6 sausages for grilling approx. 150 g each**	-	-	3	-	each side: 10-15

* lower wire rack
**higher wire rack

Poultry

Notes

- Place whole chickens and chicken breasts breast-side down. Turn after $\frac{2}{3}$ of the cooking time.
- Place poulard breast-side down. Turn after 30 minutes and set the microwave power to 180 watts.

- Place half chickens and chicken portions skin-side up. Do not turn.
- Turn the duck and goose breast skin-side up. Do not turn.
- Turn goose thighs halfway through the cooking time. Prick the skin.
- Place turkey breast and thighs skin-side down. Turn after $\frac{2}{3}$ of the cooking time.

Poultry	Accessories	Type of heating	Temperature in °C, grill setting	Microwave power in watts	Cooking time in minutes
Chicken, whole, approx. 1.2 kg*	Ovenware with lid	☉	220-230	300	35-45
Poulard, whole, approx. 1.6 kg*	Ovenware with lid	☉	220-230	300 100	30 20-30
Chicken, halves, 500 g each*	Ovenware without lid	☉	180-200	300	30-35
Chicken portions, approx. 800 g*	Ovenware without lid	☉	210-230	300	20-30
Chicken breast with skin and bones, 2 pieces, approx. 350-450 g*	Ovenware without lid	☉	190-210	100	30-40

Poultry	Accessories	Type of heating	Temperature in °C, grill setting	Microwave power in watts	Cooking time in minutes
Duck breast with skin, 2 pieces, 300-400 g each**	Ovenware without lid	—	3	100	20-30
Goose breast, 2 pieces, 500 g each*	Ovenware without lid	☺	210-230	100	25-30
Goose legs, 4 pieces, approx. 1.5 kg*	Ovenware without lid	☺	210-230	100	30-40
Turkey breast, approx. 1 kg*	Ovenware with lid	☺	200-220	-	90-100
Turkey drumsticks, approx. 1.3 kg*	Ovenware with lid	☺	200-220	100	50-60

* lower wire rack
**higher wire rack

Fish

Notes

- For grilling, place the whole fish, e.g. trout, onto the middle of the higher wire rack.
- Grease the wire rack with oil beforehand.

Fish	Accessories	Type of heating	Temperature °C	Cooking time in minutes
Fish steak, e.g. salmon, 3 cm thick, grilled	Higher wire rack	—	3	20-25
Whole fish, 2-3 pieces, 300 g each, grilled	Higher wire rack	—	3	20-30

Tips for roasting and grilling

The table does not contain information for the weight of the joint.	For small roasts, select a higher temperature and a shorter cooking time. For larger roasts, select a lower temperature and a longer cooking time.
How to tell when the roast is ready.	Use a meat thermometer (available from specialist shops) or carry out a "spoon test". Press down on the roast with a spoon. If it feels firm, it is ready. If the spoon can be pressed in, it needs to be cooked for a little longer.
The roast looks good but the juices are burnt.	Next time, use a smaller roasting dish or add more liquid.
The roast looks good but the juices are too clear and watery.	Next time, use a larger roasting dish and add less liquid.
The roast is not well-done enough.	Carve the roast. Prepare the gravy in the roasting dish and place the slices of roast meat in the gravy. Finish cooking the meat using the microwave only.

Bakes, gratins, toast with toppings

Notes

- The values in the table apply to food placed in a cold oven.
- For bakes, potato gratins and lasagne, use a microwaveable, heat-resistant ovenproof dish 4 to 5 cm deep.
- Place the bake on the lower wire rack.
- Leave bakes and gratins to cook in the oven for a further 5 minutes after switching off.
- Cheese on toast:
Pre-toast slices of bread.

Bakes, gratins, toasts	Accessories	Type of heating	Temperature in °C, grill setting	Microwave power in watts	Cooking time in minutes
Bake, sweet, approx. 1.5 kg*	Ovenware without lid	☺	140-160	300	25-35
Savoury bake, made with cooked ingredients, approx. 1 kg*	Ovenware without lid	☺	150-160	700	20-25
Lasagne, fresh*	Ovenware without lid	☺	200-220	300	25-35
Potato gratin made from raw ingredients, approx. 1.1 kg*	Ovenware without lid	☺	180-200	700	25-30
Toast with topping, 4 slices**		—	3	-	8-10













* lower wire rack
** higher wire rack

Convenience products, frozen

Notes

- Observe the instructions on the packaging.

- The values in the table apply to food placed in a cold oven.
- Do not lay chips, croquettes or potato rösti on top of each other. Turn half way through the cooking time.
- Place the food directly on the turntable.

Convenience products	Accessories	Type of heating	Temperature °C	Microwave power in watts	Cooking time in minutes
Pizza with thin base*	Turntable		220-230	-	10-15
Pizza with deep-pan base	Turntable	 	- 220-230	700 -	3 13-18
Mini pizza*	Turntable		220-230	-	10-15
Pizza baguette*	Turntable	 	- 220-230	700 -	2 13-18
Chips	Turntable		220-230	-	8-13
Croquettes*	Turntable		210-220	-	13-18
Rösti, stuffed potato pockets	Turntable		200-220	-	25-30
Part-cooked rolls or baguette	Lower wire rack		170-180	-	13-18
Fish fingers	Turntable		210-230	-	10-20
Chicken goujons, nuggets	Turntable		200-220	-	15-20
Lasagne, approx. 400 g**	Lower wire rack		220-230	700	12-17

* Preheat the cooking compartment for 5 minutes.

** Place the food in suitable, heat-resistant ovenware.