

Use & Care Guide  
Manual de Uso y Cuidado  
English / Español

Models/Modelos: 417.6173\*, 417.7173\*

# Kenmore® Laundry Center

Centro de lavado

\* = Color number, número de color

P/N A13414901 (1805)  
Sears Brands Management Corporation  
Hoffman Estates, IL 60179 U.S.A.  
[www.kenmore.com](http://www.kenmore.com)  
[www.sears.com](http://www.sears.com)



# Record Model/Serial Numbers

This *Use & Care Guide* provides general operating instructions for this laundry center. It also contains information about features for several other models. **Models vary and may not have every feature included in this document.**

Use the laundry center only as instructed in this *Use & Care Guide*.

The model and serial numbers of the washer are found on the serial plate located inside the dryer door opening. Record and retain these numbers.

Model Number \_\_\_\_\_

Serial Number \_\_\_\_\_

Purchase Date \_\_\_\_\_

## Child Safety

Destroy or recycle the carton, plastic bags, and any exterior wrapping material immediately after the laundry center is unpacked. Children should never use these items to play. Cartons covered with rugs, bedspreads, plastic sheets or stretch wrap may become airtight chambers, and can quickly cause suffocation.

## Proper Disposal Laundry Center

### Risk of Child Entrapment

Child entrapment and suffocation are not problems of the past. Junked or abandoned washers/dryers are still dangerous – even if they will sit for “just a few days”. If you are getting rid of your old washer/dryer, please follow the *Protect Children* section of the safety instructions to help prevent accidents.

## Table of Contents

<b>Record Model/Serial Numbers</b> .....	<b>2</b>
<b>Important Safety Instructions</b> .....	<b>2-6</b>
<b>Warranty Information</b> .....	<b>7</b>
<b>Washer Operating Instructions</b> .....	<b>8-10</b>
<b>Washer Controls and Settings</b> .....	<b>10-13</b>
<b>Stain Removal</b> .....	<b>13-15</b>
<b>Common Washing Problems</b> .....	<b>16-17</b>
<b>Dryer Operating Instructions</b> .....	<b>18-19</b>
<b>Dryer Controls and Settings</b> .....	<b>19-21</b>
<b>Common Drying Problems</b> .....	<b>22</b>
<b>Care and Cleaning</b> .....	<b>23-24</b>
<b>Before Calling</b> .....	<b>25-27</b>

# Important Safety Instructions

## Recognize safety symbols, words and labels

Safety items throughout this manual are labeled with a **WARNING** or **CAUTION** based on the risk type as described below:

### Definitions

**⚠** This is the safety alert symbol. It is used to alert the user of potential personal injury hazards. Obey all safety messages that follow this symbol to avoid possible injury or death.



### **DANGER**

**DANGER** indicates an imminently hazardous -ous situation which, if not avoided, will result in death or serious injury.



### **WARNING**

**WARNING** indicates a potentially hazardous situation which, if not avoided, could result in death or serious injury.



### **CAUTION**

**CAUTION** indicates a potentially hazardous situation which, if not avoided, may result in minor or moderate injury.

### **IMPORTANT**

Indicates installation, operation, or maintenance information which is important but not hazard-related.

This book contains valuable information about the operation, care and service of this appliance. Keep it in a safe place.



### **WARNING**

Please read all instructions before using this laundry center.

## Important Safety Instructions

# **WARNING**

### **FIRE OR EXPLOSION HAZARD**

**Failure to follow safety warning exactly could result in serious injury, death, or property damage.**

**DO NOT store or use gasoline or other flammable vapors and liquids in the vicinity of this or any other appliance.**

### **WHAT TO DO IF THE SMELL OF GAS IS PRESENT:**

- **DO NOT try to light any appliance.**
- **DO NOT touch any electrical switch.**
- **DO NOT use phone.**
- **Clear the room, building, or area of all occupants.**
- **Immediately call the gas supplier from a neighbor's phone. Follow the gas supplier's instructions.**
- **If the gas supplier cannot be reached, call the fire department.**

**Installation and service must be performed by a qualified installer, service agency, or the gas supplier.**

### **NOTE**

The instructions appearing in this *Use & Care Guide* are not meant to cover every possible condition and situation that may occur. Common sense and caution must be practiced when installing, operating and maintaining any appliance.

**SAVE THESE INSTRUCTIONS FOR FUTURE REFERENCE.**

# Important Safety Instructions



## WARNING - RISK OF FIRE

To reduce the risk of fire, electrical shock, or injury to persons when using this laundry center, comply with the basic warnings listed below. Failure to comply with these Important Safety Instructions and warnings could result in serious personal injuries or death.

### Prevent Fire

- DO NOT wash or dry items that have been previously cleaned in, soaked in, or spotted with gasoline, cleaning solvents, kerosene, cooking oils, waxes, etc. DO NOT store these items on or near the washer. These substances give off vapors or chemical reactions that could ignite or explode.
- DO NOT put oily or greasy rags or clothing on top of the laundry center. These substances give off vapors that could ignite the materials.
- DO NOT add gasoline, cleaning solvents, or other flammable or explosive substances to the wash water. These substances give off vapors that could ignite or explode.
- Under certain conditions, hydrogen gas may be produced in a hot water system that has not been used for 2 weeks or more. HYDROGEN GAS IS EXPLOSIVE. If the hot water system has not been used for such a period, turn on all hot water faucets and let the water flow from each for several minutes BEFORE using the washer. This will release any accumulated hydrogen gas. Hydrogen gas is flammable; DO NOT smoke or use an open flame during this time.
- DO NOT store or use gasoline or other flammable vapors or liquids in the vicinity of this or any other appliance.
- DO NOT place items exposed to cooking oils in the dryer. Items contaminated with cooking oils may contribute to a chemical reaction that could cause a load to catch fire. To reduce the risk of fire due to contaminated loads, the final

part of a tumble dryer cycle occurs without heat (cool down period). Avoid stopping a tumble dryer before the end of the drying cycle unless all items are quickly removed and spread out so that the heat is dissipated.

- DO NOT dry articles containing rubber, plastic or similar materials such as bras, galoshes, bath mats, rugs, bibs, baby pants, plastic bags, and pillows that may melt or burn. Some rubber materials, when heated, can under certain circumstances produce fire by spontaneous combustion.
- Clean lint filter before or after each load. **The interior of dryer, lint filter housing, and exhaust duct should be cleaned approximately every 18 months by qualified service personnel.** An excessive amount of lint build-up in these areas could result in inefficient drying and possible fire. See *Care and Cleaning*.
- DO NOT operate the dryer if the lint filter is blocked, damaged or missing. Fire hazard, overheating, and damage to fabrics can occur.



## WARNING

### FIRE HAZARD

**A clothes dryer produces combustible lint. The dryer must be connected to an outdoors exhaust. Regularly inspect the outdoor exhaust opening and remove any accumulation of lint around the opening and in the surrounding area.**

- DO NOT obstruct the flow of ventilating air. DO NOT stack or place laundry or throw rugs against the front or back of the dryer.
- DO NOT spray any type of aerosol into, on or near dryer at any time.
- DO NOT use fabric softeners or products to eliminate static unless recommended by the manufacturer of the fabric softener or product.
- DO NOT continue to use laundry center if squeaking, grinding, rubbing or other unusual noises are heard. This could be a

# Important Safety Instructions

sign of mechanical breakdown and lead to fire or serious injury. Contact a qualified technician immediately.

- Failure to comply with these warnings could result in fire, explosion, serious bodily injury, and/or damage to rubber or plastic parts of the laundry center.

## Protect Children

- DO NOT allow children to play on or in the laundry center. Close supervision of children is necessary when the laundry center is used near children. As children grow, teach them the proper, safe use of all appliances.
- Destroy the carton, plastic bag, and other packing materials after the laundry center is unpacked. Children might use them for play. Cartons covered with rugs, bedspreads or plastic sheets can become airtight chambers.
- Keep laundry products out of children's reach. To prevent personal injury, observe all warnings on product labels.
- Before the laundry center is removed from service or discarded, remove the washer and dryer doors to prevent accidental entrapment.
- Failure to comply with these warnings could result in serious personal injuries.

## Prevent Injury

- To prevent shock hazard and assure stability during operation, the laundry center must be installed and electrically grounded by a qualified service person in accordance with local codes. Installation instructions are packed in the washer for installer's reference. Refer to *Installation Instructions* for detailed grounding procedures. If the laundry center is moved to a new location, have it checked and reinstalled by a qualified service person.
- To prevent personal injury or damage to laundry center, the electrical power cord of a gas dryer must be plugged into a properly grounded and polarized 3-prong outlet. The third grounding prong must never be removed. Never ground the dryer to a gas pipe. DO NOT use an extension cord or an adaptor plug.
- ALWAYS disconnect the laundry center from the electrical supply before attempting any service or cleaning. Failure to do so can result in electrical shock or injury.
- DO NOT use any type spray cleanser when cleaning dryer interior. Hazardous fumes or electrical shock could occur.



## WARNING

### FIRE/ELECTRICAL SHOCK HAZARD

Avoid fire hazard or electrical shock. DO NOT use an adaptor plug or extension cord or remove grounding prong from electrical power cord. Failure to follow this warning can cause serious injury, fire, or death.

10-30R  
3-wire



(fused 30 amp)

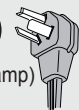

14-30R  
4-wire



(fused 30 amp)



240 v Electric Dryer

UL-approved service cord must be installed on electric dryers (not provided with unit except those manufactured for sale in Canada).

Grounding type wall receptacle



Power cord with 3-prong grounded plug

120 v Gas Dryer

Do not, under any circumstances, cut, remove, or bypass the grounding prong.



# Important Safety Instructions

- To prevent injury, DO NOT reach into the laundry center while parts are moving. Before loading, unloading or adding items, push in the cycle selector knob to stop the cycle. Allow the wash tub or dryer drum to coast to a complete stop before reaching inside.
- Follow package directions when using laundry products. Incorrect usage can produce poisonous gas - resulting in serious injury or death.
- DO NOT combine laundry products for use in 1 load unless specified on the label.
- DO NOT mix chlorine bleach with ammonia or acids such as vinegar.



## WARNING

### HARMFUL VAPOR HAZARD

Do not use or mix liquid chlorine bleach with other household chemicals such as toilet cleaners, rust removers, acid or products containing ammonia. These mixtures can produce dangerous fumes which can cause serious injury or death.



## CAUTION

The California Safe Drinking Water and Toxic Enforcement Act requires the Governor of California to publish a list of substances known to the state to cause cancer, birth defects or other reproductive harm, and requires businesses to warn customer of potential exposure to such substances. Included in this list are soot and carbon monoxide, both of which may be produced by the use of this product.

## Prevent Injury and Damage to the Appliance

To prevent serious personal injury and damage to the laundry center:

- All repairs and servicing must be performed by an authorized service agent unless specifically recommended in this *Use & Care Guide*. Use only authorized factory parts.
- DO NOT tamper with controls.
- DO NOT install or store the laundry center where it will be exposed to the weather. DO NOT operate the laundry center in below freezing temperatures.
- DO NOT install on carpet. Install laundry center on a solid floor. It may be necessary to reinforce the floor to prevent vibration or movement.
- DO NOT sit on, step on or stand on the laundry center. DO NOT rest heavy loads on top. The laundry center is not meant to support weight.
- To reduce the risk of electric shock, disconnect this appliance from the power supply before attempting any user maintenance. Canceling a cycle or turning the power off at the console does not disconnect this appliance from the power supply.
- This laundry center is equipped with an electrical overload protector. The washer motor will stop if it becomes overheated.
- A thermal limiter switch automatically turns off the dryer motor in the unlikely event of an overheated situation. A service technician must replace the thermal limiter switch after correcting the fault.
- Failure to comply with these warnings could result in property damage or serious personal injuries.

# Warranty Information

## KENMORE LIMITED WARRANTY

WITH PROOF OF SALE the following warranty coverage applies when this appliance is correctly installed, operated and maintained according to all supplied instructions.

### One Year on Appliance

FOR ONE YEAR from the date of sale this appliance is warranted against defects in material or workmanship. A defective appliance will receive free repair or replacement at option of seller.

### Lifetime on Washer Drive Motor

FOR AS LONG AS IT IS USED from the date of sale, a free replacement will be supplied for a defective washer drive motor. If the defect appears within the first year, a new motor will be installed at no charge. If the defect appears after the first year, a new motor will be supplied but not installed at no charge. This Lifetime warranty covers only the washer drive motor, and does not apply to any other related component or mechanism. You are responsible for the labor cost of motor installation after the first year from the date of sale.

### Lifetime on Dryer Drum and Baffles

FOR AS LONG AS IT IS USED from the date of sale, a free replacement will be supplied for a defective dryer drum, including baffles. If the defect appears within the first year, a new drum or baffles will be installed at no charge. If the defect appears after the first year, a new drum or baffles will be supplied but not installed at no charge. This Lifetime warranty covers only the dryer drum and baffles, and does not apply to any other related component or mechanism. You are responsible for the labor cost of drum or baffle installation after the first year from the date of sale.

For warranty coverage details to obtain free repair or replacement, visit the web page: [www.kenmore.com/warranty](http://www.kenmore.com/warranty)

All warranty coverage applies for only 90 DAYS from the sale date if this appliance is ever used for other than private household purposes.

### This warranty covers ONLY defects in material and workmanship, and will NOT pay for:

1. Expendable items that can wear out from normal use, including but not limited to filters, belts, bags or screw-in base light bulbs.
2. A service technician to clean or maintain this appliance, or to instruct the user in correct appliance installation, operation and maintenance.
3. Service calls to correct appliance installation not performed by Sears authorized service agents, or to repair problems with house fuses, circuit breakers, house wiring, and plumbing or gas supply systems resulting from such installation.
4. Damage to or failure of this appliance resulting from installation not performed by Sears authorized service agents, including installation that was not in accord with electrical, gas or plumbing codes.
5. Damage to or failure of this appliance, including discoloration or surface rust, if it is not correctly operated and maintained according to all supplied instructions.
6. Damage to or failure of this appliance, including discoloration or surface rust, resulting from accident, alteration, abuse, misuse or use for other than its intended purpose.
7. Damage to or failure of this appliance, including discoloration or surface rust, caused by the use of detergents, cleaners, chemicals or utensils other than those recommended in all instructions supplied with the product.
8. Damage to or failure of parts or systems resulting from unauthorized modifications made to this appliance.
9. Service to an appliance if the model and serial plate is missing, altered, or cannot easily be determined to have the appropriate certification logo.

### Disclaimer of implied warranties; limitation of remedies

Customer's sole and exclusive remedy under this limited warranty shall be product repair or replacement as provided herein. Implied warranties, including warranties of merchantability or fitness for a particular purpose, are limited to one year on the appliance and for as long as used on the washer drive motor and dryer drum and baffles, or the shortest period allowed by law. Seller shall not be liable for incidental or consequential damages. Some states and provinces do not allow the exclusion or limitation of incidental or consequential damages, or limitation on the duration of implied warranties of merchantability or fitness, so these exclusions or limitations may not apply to you.

This warranty applies only while this appliance is used in the United States.

This warranty gives you specific legal rights, and you may also have other rights which vary from state.

**Sears Brands Management Corporation, Hoffman Estates, IL 60179**

# Washer Operating Instructions



## WARNING

To reduce the risk of fire, electric shock or injury to persons, read these Important Safety Instructions in this *Use & Care Guide* before operating this washer.



## CAUTION



To avoid serious personal injury, **DO NOT** operate washer if safety lid lock is missing, damaged or operating improperly.



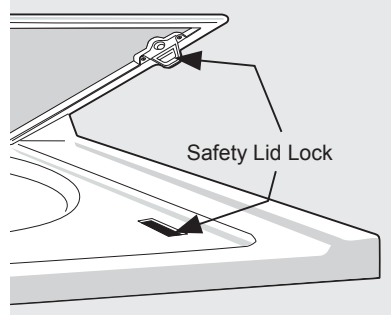

## WARNING

**DO NOT** wash water-resistant and water-repellent type clothing or other materials. Failure to closely follow these instructions may result in abnormal vibrating and out-of-balance conditions that could result in physical injury, property damage, and/or appliance damage.



Steps	Tips	Important
<p>1. Sort laundry into loads that can be washed together.</p> 	<ul style="list-style-type: none"> <li>Sort by recommended cycle and water temperature.</li> <li>Separate light, and colorfast items from dark and non-colorfast items.</li> <li>Separate items that shed lint from items that attract lint. Casual, synthetic, knit, and corduroy items will pick up lint from towels, rugs, and bedspreads.</li> <li>Separate heavily soiled items from lightly soiled items.</li> <li>Separate lacy, sheer, loosely knit, or delicate items from durable items.</li> </ul>	<ul style="list-style-type: none"> <li><b>DO NOT</b> machine wash items containing fiberglass. Small particles of fiberglass left in drum may transfer to fabrics in other loads and cause skin irritation and/or damage to fabrics.</li> <li><b>DO NOT</b> wash water-resistant and water-repellent type clothing or other materials</li> </ul>
<p>2. Prepare items for washing.</p> 	<ul style="list-style-type: none"> <li>Empty pockets.</li> <li>Brush off lint and dirt. Shake out rugs and beach towels.</li> <li>Close zippers, fasten hooks, button buttons, and tie strings/sashes. Remove non-washable trims and ornaments.</li> <li>Place delicate and small items such as bras and hosiery in a mesh bag (not included).</li> </ul>	<ul style="list-style-type: none"> <li>Mend rips and tears to prevent further damage during washing.</li> <li>Turn knit items inside out to prevent pilling.</li> </ul>
<p>3. Pretreat stains and heavy soil.</p>	<ul style="list-style-type: none"> <li>See <i>Stain Removal Guide</i> in this guide for safe, successful stain removal instructions.</li> </ul>	

# Washer Operating Instructions

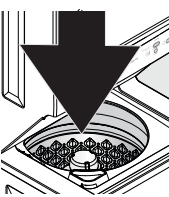
Steps	Tips	Important
<p>4. Add liquid detergent or powder detergent to wash tub before adding load.</p>	<ul style="list-style-type: none"> <li>• Detergent packs can also be used but may not fully dissolve in some cycles.</li> <li>• The amount of detergent required depends on the type of detergent, load size, and water hardness.</li> </ul>	<ul style="list-style-type: none"> <li>• Follow manufacturer's instructions for recommended amount of detergent.</li> <li>• Use a low-sudsing, high-efficiency detergent to prevent oversudsing.</li> <li>• Look for the high-efficiency symbol on the detergent label. </li> </ul>
<p>5. Add other wash products to wash tub (if desired).</p>	<ul style="list-style-type: none"> <li>• Water conditioners, detergent boosters, and enzyme products may be added with detergent.</li> </ul>	<ul style="list-style-type: none"> <li>• See product manufacturer's instructions.</li> </ul>
<p>6. Add bleach (if desired) before adding load.</p> 	<ul style="list-style-type: none"> <li>• If using <b>liquid bleach</b>, add to bleach dispenser located in left front corner under lid. Then add 1 cup (240 ml) water to flush dispenser.</li> <li>• If using <b>powdered bleach</b>, add directly to the empty tub.</li> </ul>	<ul style="list-style-type: none"> <li>• Follow manufacturer's instructions for recommended amount of bleach.</li> <li>• <b>DO NOT</b> use powdered bleach in bleach dispenser.</li> </ul>
<p>7. Add laundry load to wash tub.</p> 	<ul style="list-style-type: none"> <li>• Add items one at a time, each tightly bunched into its own "ball" to allow beneficial item interaction. Avoid loading items in a flat, laid-out fashion.</li> <li>• For best washing performance, dry load level should not be higher than the upper row of holes in the wash tub.</li> <li>• Combine large and small items in a load. Load small items first. Large items should not be more than half the total wash load.</li> <li>• When washing a single heavy item, add 1 or 2 towels to balance the load.</li> </ul>	<ul style="list-style-type: none"> <li>• <b>DO NOT</b> overload the washer.</li> </ul>
<p>8. Add liquid fabric softener to the final rinse (if desired).</p>	<ul style="list-style-type: none"> <li>• Add diluted fabric softener to the final rinse following fabric softener manufacturer's instructions.</li> <li>• A fabric softener dispensing ball can also be used.</li> </ul>	<ul style="list-style-type: none"> <li>• To prevent staining, <b>DO NOT</b> pour liquid fabric softener directly on to wash load.</li> <li>• Use of multi-product (detergent plus softener) sheets or color-absorbing sheets <b>NOT</b> recommended. They could damage or disable the machine.</li> </ul>

# Washer Operating Instructions

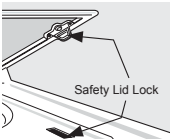
Steps	Tips	Important
9. Select washing cycle and settings for each load.	<ul style="list-style-type: none"> <li>• See <i>Washer Cycle Selection</i> and <i>Washer Cycle Settings</i>.</li> <li>• Unit will emit three short beeps to indicate it is in “wake” mode and ready to operate.</li> </ul>	<ul style="list-style-type: none"> <li>• For best results, follow fabric care label on items to be washed.</li> </ul>
10. Close the washer lid and start the washer.	<ul style="list-style-type: none"> <li>• See <i>Washing Cycle Controls (Start, Pause, and Cancel)</i>.</li> <li>• LED will light solid when washer is running.</li> </ul>	<ul style="list-style-type: none"> <li>• Pausing a wash cycle while washer is running may affect performance of the wash cycle.</li> </ul>
11. Remove items when the cycle is completed. 	<ul style="list-style-type: none"> <li>• For safety, the lid is locked during the operation of the washer.</li> <li>• Once cycle has ended, wash tub will come to a complete stop and door lid safety lock will disengage with an audible double click.</li> <li>• Place washed items in automatic dryer, line dry, or dry flat as directed by fabric care label. Excess wrinkling, color transfer or odors may develop in items left in the washer after the cycle has ended.</li> </ul>	<ul style="list-style-type: none"> <li>• <b>DO NOT force open the locked lid.</b> The wash tub can take several minutes to stop.</li> <li>• For best results, follow fabric care label on items to be dried.</li> <li>• For safety, the lid will remain locked for 6 minutes after the cycle ends.</li> </ul>

## Washer Controls and Settings

### Washing Setting Chart

These temperatures and water levels are available with the following cycles.

Express	Delicates	Workout Wear	Normal	Bulky   Bedding	Heavy Duty	Colors	Casual	Soak	Rinse & Spin
✓		✓	✓	✓	✓	✓	✓	✓	
✓	✓	✓	✓	✓	✓	✓	✓	✓	
✓	✓	✓	✓	✓	✓	✓	✓	✓	✓

#### Water Temperature

Hot	✓		✓	✓	✓	✓	✓	✓	✓	
Warm	✓	✓	✓	✓	✓	✓	✓	✓	✓	
Cold	✓	✓	✓	✓	✓	✓	✓	✓	✓	✓

#### Water Level

Max Fill	✓	✓	✓	✓	✓	✓	✓	✓	✓	✓
Med	✓	✓	✓	✓	✓	✓	✓	✓	✓	✓
Low	✓	✓	✓	✓	✓	✓	✓	✓	✓	✓

✓ = Available selections. □ = Factory presets.

See **Washing Cycle Selection** and **Washing Cycle Settings** on the following pages for a detailed description of each setting.

# Washer Controls and Settings

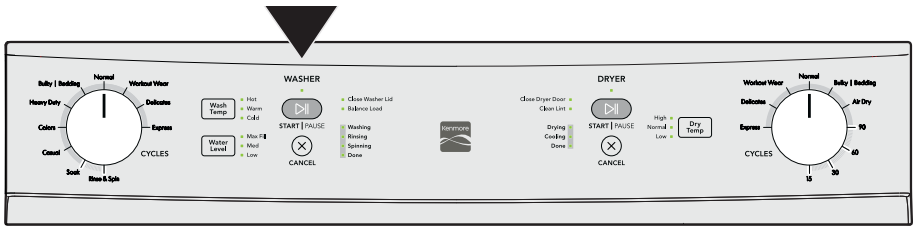

This manual covers many models and not all cycles, options, or features listed are available on every model. Consoles shown above for reference only. Models may vary.

## Washing Cycle Selection

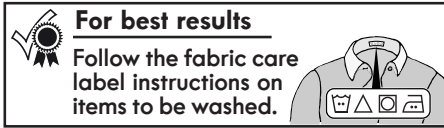

Turn the washer cycle selector in either direction to select a washing cycle.

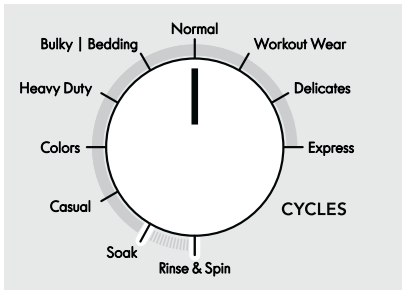

### Normal

Select this cycle for normally soiled cottons, linens, towels, shirts, denims, and mixed loads.

### NOTE

**TO MAXIMIZE ENERGY EFFICIENCY**  
Perform normal cycle with energy saver option selected (if available) and rinse level in the auto position (if available).

### Workout Wear

Select this cycle for small loads of light-weight, synthetic apparel worn for working out, running, swimming, cycling, tennis, and similar activities when removal of light soil and perspiration are important.

### Delicates

Select this cycle for lightly soiled knits and delicates which require gentle washing.

### Express

Select this cycle to quickly wash a small, lightly soiled load in 35 minutes.

### Rinse & Spin

Select this cycle for loads that require a cold water rinse or to add fabric softener that omitted in a regular cycle.

### Soak

Select this cycle to soak heavily soiled and stained items before washing. Cold water is recommended with this cycle as warmer water may set some stains. Use the amount of detergent recommended for a normal wash cycle. If desired, use a bleach or a soaking agent safe for the fabric. The washer will continue on with a soil-loosening wash cycle immediately after the soak phase.

### Casual

Select this cycle for lightly soiled cottons, linens, towels, shirts, denims, and mixed loads.

### Colors

Select this cycle for lightly soiled, dark, or highly dyed fabrics which may be susceptible to dye loss.

### Heavy Duty

Select this cycle for heavily soiled cottons, linens, towels, shirts, denims, and mixed loads.

### Bulky | Bedding

Select this cycle for bulky items such as comforters, blankets, mattress pads, sleeping bags, and other similar items.

# Washer Controls and Settings

## NOTE

Washers connected to water supplies with lower inlet pressure will experience longer filling times and may not complete cycle as quickly.

## Washing Cycle Settings

### Wash Temp (Water Temperature)



Press the **Wash Temp** button to cycle through wash water temperatures until the desired temperature is selected. The LED will light to indicate the current selection. Select a wash water temperature according to fiber content, colorfastness, and soil level. To protect fabrics, the temperature range of cold to hot settings may be different depending on cycle selected.

The water heater setting, its distance from the washer, water usage in other parts of the home, and seasonally low ground water temperature in some geographic areas can affect water temperature.

### Hot

Select this setting for heavily soiled white or colorfast cottons and blends.

### Warm

Select this setting for normally soiled white or colorfast cottons or blends.

### Cold

Select this setting for lightly soiled non-colorfast items, knits, delicates, and hand washables. Some warm water will automatically blend with cold tap supply to achieve cold.

## Water Level



Press the **Water Level** button to cycle through wash water level until the desired water level is selected. The recommended water level can be determined by the size of the wash load.

### Max Fill

Select the Max Fill water level setting if the tub is over one half (1/2) full.

### Med (Medium)

Select the Med water level setting if the tub is between one third (1/3) and one half (1/2) full.

### Low

Select the Low setting if the tub is one third (1/3) or less full.

The **Med** and **Max Fill** settings are also recommended for heavily soiled loads to remove excess dirt and detergent or if household members have sensitive skin.

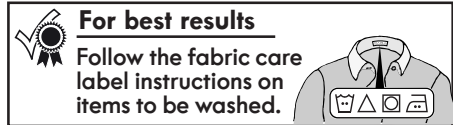

# Washer Controls and Settings

## Washing Cycle Controls

(Start, Pause, and Cancel)

### Start

Press the washer **START | PAUSE** button once to begin the wash cycle. The unit will emit two short beeps, the LED will turn solid green, and the door lid lock will engage with an audible double click.

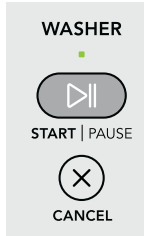

### Pause

Press the washer **START | PAUSE** button once while the washer is running to pause the wash cycle. The unit will emit one short beep, the LED will blink, the wash tub will come to a complete stop, and the door lid safety lock will disengage with an audible double click. The wash tub can take several minutes to stop after the **START | PAUSE** button is pressed. **DO NOT** force open the locked lid. Press the **START | PAUSE** button again to restart the wash cycle.

### Cancel

Press the washer **CANCEL** button to cancel the wash cycle. The unit will emit one long beep, the wash tub will come to a complete stop, and the door lid safety lock will disengage with an audible double click. **The wash tub can take several minutes to stop after the CANCEL button is pressed. DO NOT force open the locked lid.**

## Washing Cycle Indicator Lights

The washing cycle indicator lights provide information during the wash cycle.

**The Close Washer Lid** advisory LED will illuminate if the washer lid is

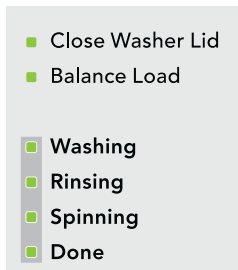

# Stain Removal

open. Fully close the washer lid before starting the washer. The washer will not operate with the lid open.

The **Balance Load** advisory LED indicator will illuminate if the wash load is unbalanced in the drum during the wash cycle. Pause the washer and redistribute the wash load.

The **Cycle Status Lights** will illuminate as each stage of the wash cycle is reached.

Cycle Status Light stages include:

**Washing, Rinsing, Spinning and Done.**

## Safe Stain Removal Procedures

- Remove stains promptly.
- Follow the recommended treatment in the stain removal chart on the next page.
- To pretreat stains, use a prewash product, liquid detergent, or a paste made from powder detergent and water.
- Use cold water on unknown stains as hot water can set stains.
- Consult care label instructions for treatments to avoid on specific fabrics.
- Check for colorfastness by testing stain remover products on an inside seam.
- Rinse and wash items after stain removal.



## WARNING

**To reduce the risk of fire or serious injury to persons or property, comply with the basic warnings listed below:**

- **Read and comply with all instructions on stain removal products.**
- **Keep stain removal products in their original labeled containers and out of children's reach.**

# Stain Removal



## WARNING

To reduce the risk of fire or serious injury to persons or property, comply with the basic warnings listed below:

- **DO NOT** combine stain removal products, especially ammonia and chlorine bleach. Dangerous fumes can result.
- Never wash items which have been previously cleaned in, washed in, soaked in or spotted with gasoline, dry cleaning solvents or other flammable or explosive substances because they give off vapors that could ignite or explode.
- Never use highly flammable solvents, such as gasoline, inside the home. Vapors can explode on contact with flames or sparks.



## WARNING

### HARMFUL VAPOR HAZARD

**DO NOT** use or mix liquid chlorine bleach with other household chemicals such as toilet cleaners, rust removers, acid or products containing ammonia. These mixtures can produce dangerous fumes which can cause serious injury or death.

## Stain Removal Suggestions

Stain	Treatment
Adhesive tape, rubber cement, gum	Apply ice. Scrape off excess. Place stain face down on paper towels. Saturate with prewash stain remover or nonflammable dry cleaning fluid.
Baby formula, dairy products, egg	Use product containing enzymes to pretreat or soak stains. Soak for 30 minutes or more. Wash.
Beverages (coffee, alcoholic beverages, tea, soda, juice)	Pretreat stain. Wash using cold water and bleach safe for fabric.
Blood	Rinse with cold water. Rub with bar soap. Or, pretreat or soak with product containing enzymes. Wash using bleach safe for fabric.
Candle wax, crayon	Scrape off surface wax. Place stain face down between paper towels. Press with warm iron until wax is absorbed. Replace paper towels frequently. Treat remaining stain with prewash stain remover or nonflammable dry cleaning fluid. Hand wash to remove solvent. Wash using bleach safe for fabric
Chocolate	Pretreat or soak in warm water using product containing enzymes. Wash using bleach safe for fabric.
Collar or cuff soil, cosmetics	Pretreat with prewash stain remover or rub with bar soap.

# Stain Removal

## Stain Removal Suggestions (continued)

Stain	Treatment
Dye transfer on white fabric	Use packaged color remover. Wash using bleach safe for fabric.
Grass	Pretreat or soak in warm water using product containing enzymes. Wash using bleach safe for fabric.
Grease, oil, tar (butter, fats, cooking oils, car grease, motor oils)	Scrape residue from fabric. Pretreat. Wash using hottest water safe for fabric. For heavy stains and tar, apply nonflammable dry cleaning fluid to back of stain. Replace towels under stain frequently. Rinse thoroughly. Wash using hottest water safe for fabric.
Ink	Some inks may be impossible to remove. Washing may set some inks. Use prewash stain remover, denatured alcohol or nonflammable dry cleaning fluid.
Mildew, scorch	Wash with chlorine bleach if safe for fabric. Or, soak in oxygen bleach and hot water before washing. Badly mildewed fabrics may be permanently damaged.
Mud	Brush off dry mud. Pretreat or soak with product containing enzymes.
Mustard, tomato	Pretreat with prewash stain remover. Wash using bleach safe for fabric.
Nail polish	May be impossible to remove. Place stain face down on paper towels. Apply nail polish remover to back of stain. Repeat, replacing paper towels frequently. DO NOT use on acetate fabrics.
Paint, varnish	WATER-BASED: Rinse fabric in cool water while stain is wet. Wash. Once paint is dry, it cannot be removed. OIL-BASED AND VARNISH: Use solvent recommended on can label. Rinse thoroughly before washing.
Perspiration	Use prewash stain remover or rub with bar soap. Rinse. Wash using non-chlorine bleach in hottest water safe for fabric.
Rust, brown or yellow discoloration	Use rust remover safe for fabric. DO NOT use chlorine bleach because it may intensify discoloration.
Shoe polish	LIQUID: Pretreat with a paste of powder detergent and water. PASTE: Scrape residue from fabric. Pretreat with prewash stain remover or nonflammable dry cleaning fluid. Rinse. Rub detergent into dampened area. Wash using bleach safe for fabric.
Tomato	Pretreat with prewash stain remover. Wash using bleach safe for fabric.
Urine, vomit, mucus, feces	Pretreat or soak in product containing enzymes. Wash using bleach safe for fabric.
Wine	Pretreat or soak in cold water. Wash in hot water using bleach safe for fabric.

# Common Washing Problems

## Common Washing Problems

Many washing problems involve poor soil and stain removal, residues of lint and scum, and fabric damage. For satisfactory washing results, follow these suggestions provided by The Soap and Detergent Association.

Problem	Possible Causes	Solutions	Preventive Measures
Blue stains	<ul style="list-style-type: none"> <li>• Undiluted liquid detergent or fabric softener dispensed directly onto fabric.</li> </ul>	<ul style="list-style-type: none"> <li>• If caused by detergent, mix 1 cup (240 ml) white vinegar with 1 quart (.95 L) water in a plastic container. Soak item for 1 hour, then rinse.</li> <li>• If caused by fabric softener, rub with bar soap and rewash.</li> </ul>	<ul style="list-style-type: none"> <li>• Add detergent to empty tub. <b>DO NOT</b> pour on dry load.</li> <li>• Avoid overfilling fabric softener compartment of dispenser.</li> </ul>
Discoloration, graying	<ul style="list-style-type: none"> <li>• Not enough detergent.</li> <li>• Wash water temperature too low.</li> <li>• Incorrect sorting.</li> </ul>	<ul style="list-style-type: none"> <li>• Rewash with correct amount of detergent and hottest water safe for fabric.</li> <li>• Add bleach safe for fabric.</li> </ul>	<ul style="list-style-type: none"> <li>• Sort items by soil level and color.</li> <li>• Use correct amount of detergent, hottest water, and bleach safe for fabric.</li> </ul>
Greasy, oily stains	<ul style="list-style-type: none"> <li>• Not enough detergent.</li> <li>• Undiluted liquid fabric softener poured directly on fabric.</li> </ul>	<ul style="list-style-type: none"> <li>• Treat with prewash stain remover or liquid detergent.</li> <li>• Increase detergent and water temperature. Rewash.</li> <li>• Rub fabric softener stains with bar soap and rewash.</li> <li>• See <i>Washer Operating Instructions</i>.</li> </ul>	<ul style="list-style-type: none"> <li>• Use correct amount of detergent and hottest water safe for fabric.</li> <li>• <b>DO NOT</b> pour liquid fabric softener directly on fabric.</li> </ul>
Holes, tears, or snags	<ul style="list-style-type: none"> <li>• Incorrect use of chlorine bleach.</li> <li>• Unfastened zippers, hooks, and buckles.</li> <li>• Rips, tears, and broken threads.</li> <li>• Overloading washer.</li> <li>• Degradation of fabric.</li> </ul>	<ul style="list-style-type: none"> <li>• May be irreversible if rips, tears, and seams cannot be mended.</li> <li>• See <i>Washer Operating Instructions</i>.</li> </ul>	<ul style="list-style-type: none"> <li>• <b>DO NOT</b> pour chlorine bleach directly on fabric.</li> <li>• Check condition of items before washing.</li> </ul>
Lint	<ul style="list-style-type: none"> <li>• Incorrect sorting.</li> <li>• Tissues left in pocket.</li> <li>• Overloading washer.</li> <li>• Not enough detergent.</li> <li>• Undissolved detergent has left residue resembling lint.</li> <li>• Static cling attracting lint.</li> <li>• Load washed too long.</li> </ul>	<ul style="list-style-type: none"> <li>• Reduce load size. Rewash using correct water temperature, water level, and amount of detergent.</li> <li>• Add non precipitating water conditioner to wash water to remove detergent residue.</li> <li>• Add fabric softener to final rinse.</li> <li>• Dry load in dryer.</li> <li>• Remove lint with lint brush or roller.</li> </ul>	<ul style="list-style-type: none"> <li>• Follow <i>Washer Operating Instructions</i>, steps.</li> <li>• <b>DO NOT</b> overload washer.</li> <li>• Use correct temperature, amount of detergent, water, and wash time.</li> </ul>

# Common Washing Problems

## Common Washing Problems (continued)

Problem	Possible Causes	Solutions	Preventive Measures
Pilling (Fibers ball up and cling to fabric)	<ul style="list-style-type: none"> <li>Pilling is normal with synthetic and permanent press fabrics due to abrasion from normal wear.</li> </ul>	<ul style="list-style-type: none"> <li>Use a lint brush or shaver to remove pills.</li> </ul>	<ul style="list-style-type: none"> <li>Use fabric softener in washer to lubricate fibers.</li> <li>When ironing, use spray starch or fabric finish on collars and cuffs.</li> <li>Turn items inside out to reduce abrasion.</li> </ul>
Residue or powder on dark items; Stiff, harsh fabrics	<ul style="list-style-type: none"> <li>Undissolved detergent.</li> <li>Some granular detergents can combine with hard water minerals to form a residue.</li> <li>Overloading the washer.</li> </ul>	<ul style="list-style-type: none"> <li>Rewash load.</li> </ul>	<ul style="list-style-type: none"> <li>Increase water temperature using hottest water safe for fabric.</li> <li>DO NOT overload washer.</li> <li>Use liquid detergent or non precipitating water conditioner with powder detergent.</li> </ul>
Unexpected washing results of large items	<ul style="list-style-type: none"> <li>Poor movement of large items during wash action.</li> <li>Large items loaded incorrectly in a flat fashion.</li> </ul>	<ul style="list-style-type: none"> <li>Rearrange load and rewash.</li> </ul>	<ul style="list-style-type: none"> <li>Add items one at a time, each tightly bunched into its own "ball" to allow beneficial item interaction.</li> <li>Avoid loading items in a flat, laid-out fashion.</li> </ul>
Wrinkling	<ul style="list-style-type: none"> <li>Overloading the washer.</li> <li>Incorrect wash cycle for wash load.</li> </ul>	<ul style="list-style-type: none"> <li>Reduce load size.</li> <li>Rinse in cold water with liquid fabric softener using the casual or delicate cycle.</li> </ul>	<ul style="list-style-type: none"> <li>DO NOT overload washer.</li> <li>Remove items from washer as soon as cycle is completed.</li> <li>Use liquid fabric softener.</li> </ul>
Yellow buildup of body soil on synthetic fabrics	<ul style="list-style-type: none"> <li>Agitation time too short.</li> <li>Water temperature too low.</li> <li>Not enough detergent.</li> </ul>	<ul style="list-style-type: none"> <li>Soak in detergent booster or product containing enzymes.</li> <li>Wash in hottest water safe for fabric using casual cycle.</li> <li>Increase detergent.</li> <li>Add bleach safe for fabric or treat with color remover.</li> </ul>	<ul style="list-style-type: none"> <li>Select correct wash cycle.</li> <li>Use correct amount of detergent.</li> <li>Wash synthetics frequently using hot or warm water.</li> </ul>
Yellow or brown rust stains	<ul style="list-style-type: none"> <li>Iron or manganese in water supply, water pipes, or water heater.</li> </ul>	<ul style="list-style-type: none"> <li>To restore discolored load of whites, use rust remover safe for fabric.</li> <li>DO NOT use chlorine bleach to remove rust stains. It may intensify discoloration.</li> </ul>	<ul style="list-style-type: none"> <li>Use non precipitating water softener.</li> <li>Before washing, run hot water for a few minutes to clear lines.</li> <li>Drain water heater occasionally.</li> <li>For an ongoing problem, install iron filter in water supply system.</li> </ul>

# Dryer Operating Instructions

## Drying Procedures



### WARNING

To reduce the risk of fire, electric shock or injury to persons, read these Important Safety Instructions in this *Use & Care Guide* before operating this washer.



### CAUTION

- **DO NOT** operate dryer without lint filter in place.
- **ALWAYS** clean filter after each load.

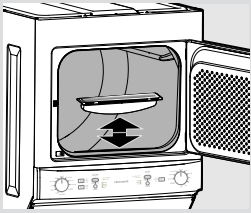
Steps	Tips	Important
<p>1. Prepare load for drying.</p>	<ul style="list-style-type: none"> <li>• Dry items of similar fabric, weight, and construction in the same load.</li> <li>• Separate dark items from light-colored items. Separate items that shed lint from those that attract lint.</li> <li>• Check for stains which may not have been removed in washing. Repeat stain removal process and wash again before drying.</li> <li>• Place delicate/small items in a mesh bag (not included).</li> <li>• Be sure buckles, buttons, and trim are heat-proof and won't damage the drum finish. Close zippers, buttons, hooks, and hook and loop fasteners. Tie strings and sashes to prevent snagging and tangling.</li> </ul>	<ul style="list-style-type: none"> <li>• Dryer heat may permanently set some stains.</li> </ul>
<p>2. Check that the lint filter is clean and in place.</p>		<ul style="list-style-type: none"> <li>• <b>DO NOT</b> operate dryer without lint filter in place.</li> <li>• <b>DO NOT</b> operate dryer without cleaning the filter before use.</li> </ul>
<p>3. Load the dryer and close the door.</p>	<ul style="list-style-type: none"> <li>• Load items loosely. The average wet load will fill the drum 1/3 to 1/2 full. Items need room to tumble freely for even drying and less wrinkling.</li> <li>• If desired, place a dryer fabric softener sheet on top of the load at the beginning of the cycle.</li> <li>• When drying large items, dry only two or three items at a time. Fill out the load with smaller items.</li> <li>• For delicate or very small loads, add two or three similar items to improve tumbling action.</li> </ul>	<ul style="list-style-type: none"> <li>• <b>DO NOT</b> overload the dryer.</li> </ul>

# Dryer Operating Instructions

## Drying Procedures (continued)

Steps	Tips	Important
4. Select the cycle and settings for each load.	<ul style="list-style-type: none"> <li>• See <i>Drying Cycle Selection</i> and <i>Drying Cycle Settings</i> on the following pages.</li> <li>• <i>Over-drying can cause wrinkles, shrinkage, lint, harshness, and build up of static electricity.</i></li> </ul>	<ul style="list-style-type: none"> <li>• For best results, follow fabric care label on items to be dried.</li> </ul>
5. Start the dryer.	<ul style="list-style-type: none"> <li>• If drying a single large or bulky item, such as a comforter, remove the item part way through the cycle and turn it “inside out” to maximize drying effectiveness. Place item back in dryer and re-start cycle.</li> <li>• See <i>Drying Cycle Controls (Start, Pause, and Cancel)</i> on the following pages.</li> </ul>	<ul style="list-style-type: none"> <li>• The dryer <b>WILL NOT</b> operate with the door open.</li> </ul>
6. Remove items when cycle is completed.	<ul style="list-style-type: none"> <li>• Immediately hang or fold when the load is completed.</li> </ul>	<ul style="list-style-type: none"> <li>• <b>ALWAYS</b> clean filter after each use.</li> </ul>

## Dryer Controls and Settings

### Dryer Setting Chart

These temperatures and water levels are available with the following cycles.

Express (25 min.)	Delicates (Auto dry)	Workout Wear (Auto dry)	Normal (Auto dry)	Bulky   Bedding (Auto dry)	Air Dry (30 min)	90 min	60 min	30 min	15 min

### Dry Temp (Temperature)

High	✓			✓	✓	✓	✓	✓	✓
Normal			✓	✓	✓		✓	✓	✓
Low		✓	✓	✓	✓		✓	✓	✓

✓ = Available selections. □ = Factory presets. ■ = Non-modifiable presets.

See **Drying Cycle Selection** and **Drying Cycle Settings** on the following pages for a detailed description of each setting.

# Dryer Controls and Settings

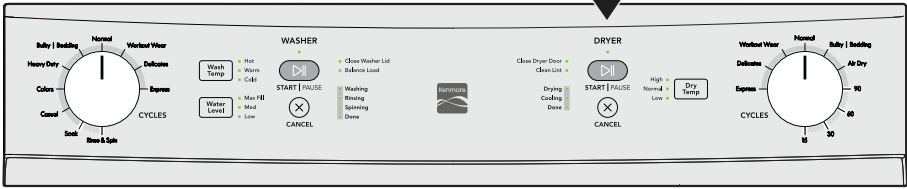

This manual covers many models and not all cycles, options, or features listed are available on every model. Consoles shown above for reference only. Models may vary.

## Drying Cycle Selection

**For best results**  
Follow the fabric care label instructions on items to be washed.

Turn the **DRYER** cycle selector in either direction to select a drying cycle.

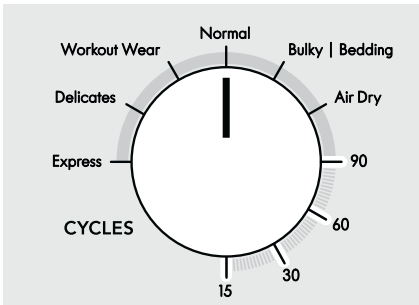

### NOTE

To change settings after the cycle starts, press the **START | PAUSE** button and adjust the setting. Press the **START | PAUSE** button again to resume the cycle.

## Auto Dry Cycles

Auto Dry cycles take the guesswork out of selecting the correct drying time for each load. With auto dry cycles, the load will automatically be dried at the selected temperature. When the load has neared the end of the drying cycle, it will continue to tumble for a brief cool down period.

This helps reduce wrinkling and makes items easier to handle during unloading.

Drying time varies depending on size of load, dampness of load, and fabric type.

Available auto dry settings are as follows:

### Normal

Select this cycle to dry everyday fabrics including cottons, linens, and sheets.

### Bulky | Bedding

Select this cycle for bulky items such as comforters, blankets, mattress pads, sleeping bags, and other similar items.

### Delicates

Select this cycle to dry cottons, blends, and permanent press items with a no-iron finish.

### Workout Wear

Select this specialty cycle to dry lightweight synthetic athletic apparel including stretch fabrics.

## Timed Dry Cycles



### WARNING

#### FIRE HAZARD

To avoid fire hazard, **DO NOT** use heat to dry items containing feathers or down, foam rubber, plastics similarly textured, rubber-like materials. Use a Timed Dry cycle with the Air Dry setting.

# Dryer Controls and Settings

## Express

Select this timed cycle to quickly dry a small load made up of just a few items. It provides approximately 25 minutes of tumbling including a cool down period.

## Timed Dry

Select a timed drying cycle for any load using one of the preset cycles of **15, 30, 60, or 90** minutes. The dryer will continue to heat throughout the cycle until the final cool down period.

## Air Dry

Select this cycle for loads that require air drying only. No heat will be used with this setting. This setting should be used for dry items such as items containing feathers, down, foam rubber, plastics, or rubber-like materials; to refresh clothing, stuffed animal, pillows, or blankets; and to dust draperies.

## Drying Cycle Settings

### Drying Temperature (Dry Temp)



Select the temperature setting most suitable for each load. To protect fabrics, not all temperatures are available with every cycle. If an unavailable temperature setting is selected by the user, the nearest available temperature will be substituted.

### High

Recommended for durable fabrics and towels.

### Normal

Recommended for most cotton fabrics.

### Low

Recommended for delicate fabrics.

## NOTE

Air Fluff setting does not use heat and **WILL NOT** illuminate any of the Dry Temp LED lights.

## Drying Cycle Controls

### (Start, Pause, and Cancel)

#### START

Press Dryer **START | PAUSE** button once to begin the drying cycle. The unit will emit one beep before the drum begins to rotate.



#### PAUSE

Press Dryer **START | PAUSE** button while the dryer is running to pause the drying cycle. Opening the door with a cycle running will also pause the cycle. Two beeps will emit from the unit. **Allow the drum to come to a complete stop before reaching inside.** Press the Dryer **START | PAUSE** button while paused to restart the drying cycle.

#### CANCEL

Press the Dryer **CANCEL** button to cancel the drying cycle. Wait for the drum to come to a complete stop before reaching inside.

## Drying Cycle Indicator Lights

The drying cycle indicator lights provide information during the dry cycle.

The **Close Dryer Door** advisory LED will illuminate if the dryer door is open.

Fully close the dryer door before starting the dryer. The dryer will not operate with the door open.

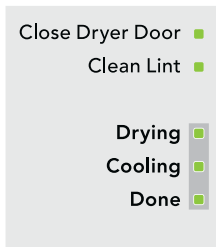

# Common Drying Problems

The **Clean Lint** advisory LED will illuminate after each drying cycle. **Clean the lint filter after every use.**

The **cycle status lights** will illuminate as each stage of the drying cycle is reached. Stages include: **Drying, Cooling, and Done.**

## Common Drying Problems

Many drying problems involve poor cleaning results, poor soil and stain removal, residues of lint and scum, and fabric damage. For satisfactory drying results, follow these suggestions provided by The Soap and Detergent Association.

Problem	Possible Causes	Solutions	Preventive Measures
Greasy, oily stains	<ul style="list-style-type: none"> <li>• Use of fabric softener sheet.</li> </ul>	<ul style="list-style-type: none"> <li>• Rub fabric softener stains with bar soap. Rinse and rewash.</li> </ul>	<ul style="list-style-type: none"> <li>• Add a few bath towels to small loads for proper tumbling.</li> <li>• Some “silk-like” fabrics should be air dried.</li> <li>• Use proper drying temperature.</li> <li>• Place fabric softener sheet in load before starting the dryer.</li> </ul>
Lint	<ul style="list-style-type: none"> <li>• Overloading the dryer.</li> <li>• Overdrying causes static electricity.</li> <li>• Lint filter not clean when cycle began.</li> <li>• Lint attached to “pills.”</li> </ul>	<ul style="list-style-type: none"> <li>• Reduce load size and rewash using liquid fabric softener in the final rinse.</li> <li>• Add a fabric softener sheet and tumble with no heat.</li> <li>• Use lint brush or roller to remove lint.</li> </ul>	<ul style="list-style-type: none"> <li>• DO NOT overload dryer.</li> <li>• Use fabric softener in washer or dryer to reduce static electricity.</li> <li>• Remove items when slightly damp to avoid overdrying.</li> <li>• Check that lint filter is clean and in place.</li> </ul>
Pilling (Fibers break off, ball up and cling to fabric)	<ul style="list-style-type: none"> <li>• Overdrying.</li> </ul>	<ul style="list-style-type: none"> <li>• Use a lint brush or shaver to remove pills.</li> </ul>	<ul style="list-style-type: none"> <li>• Use fabric softener to lubricate fibers.</li> <li>• If ironing, use spray starch or fabric finish on collars and cuffs.</li> <li>• Turn items inside out to reduce abrasion.</li> </ul>
Shrinking	<ul style="list-style-type: none"> <li>• Temperature too high.</li> <li>• Overdrying.</li> </ul>	<ul style="list-style-type: none"> <li>• Irreversible condition.</li> </ul>	<ul style="list-style-type: none"> <li>• Follow fabric care label directions.</li> <li>• If shrinking is a concern, check load often.</li> <li>• Remove items while slightly damp and hang or lay flat to complete drying.</li> <li>• Block knits into shape.</li> </ul>
Wrinkling	<ul style="list-style-type: none"> <li>• Overloading the dryer.</li> <li>• Leaving items in dryer after cycle ends.</li> </ul>	<ul style="list-style-type: none"> <li>• Reduce load size and tumble at medium or low heat for 5-10 min.</li> <li>• Remove items immediately. Hang or fold.</li> </ul>	<ul style="list-style-type: none"> <li>• DO NOT overload dryer.</li> <li>• Remove items as soon as cycle ends.</li> </ul>

# Care and Cleaning



## WARNING

### FIRE HAZARD

A clothes dryer produces combustible lint. The dryer must be connected to an outdoors exhaust. Regularly inspect the outdoor exhaust opening and remove any accumulation of lint around the opening and in the surrounding area.

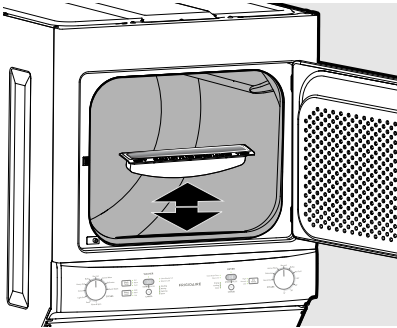

## IMPORTANT

Clean the lint filter after every load.



## WARNING

To reduce risk of fire or serious injury to persons or property, comply with the basic warnings listed in the Important Safety Instructions and in this *Care and Cleaning* section.



## WARNING

### FIRE HAZARD / HARMFUL VAPOR HAZARD

Before cleaning the laundry center interior, unplug the electrical power cord to avoid electrical shock hazards.



## WARNING

### FIRE HAZARD / HARMFUL VAPOR HAZARD

**DO NOT** use any type spray cleanser when cleaning the dryer interior. Hazardous fumes or electrical shock could occur.

- Clean the lint filter after every load. Lint build-up on the filter restricts air flow, which causes longer drying times. The filter is located at the bottom of the door opening. Remove by pulling straight up. Remove the lint and replace the filter.
- Occasionally a waxy build-up may form on the lint filter from using dryer-added fabric softener sheets. To remove this build-up, wash the filter with warm, soapy water. Dry the filter thoroughly and replace. **DO NOT** operate the dryer without the lint filter in place.
- If the dryer drum becomes stained from non colorfast fabrics, clean the drum with a damp cloth and a mild liquid household cleanser. Remove cleanser residue before drying the next load.
- **Every 18 months a qualified service personnel should clean the dryer cabinet interior and exhaust duct. These areas can collect lint and dust over time. An excessive amount of lint build-up could result in inefficient drying and possible fire hazard.**

## Cleaning Inside of Washer

- Remove items from the washer as soon as the cycle ends. Excess wrinkling, color transfer, and odors may develop in items left in the washer.
- Dry the washer top, the area around the lid opening, and the underside of the lid. These areas should always be dry before the lid is closed.

# Care and Cleaning

- Before cleaning the washer interior, unplug the electrical power cord to avoid electrical shock hazards.
- When extremely soiled items have been washed, a dirty residue may remain on the tub. Remove this by wiping the tub with a nonabrasive household cleanser. Rinse thoroughly with water.
- The base plate or tub may become stained from fabric dye. Clean these parts with a nonabrasive household cleanser. This prevents dye transfer to future loads.

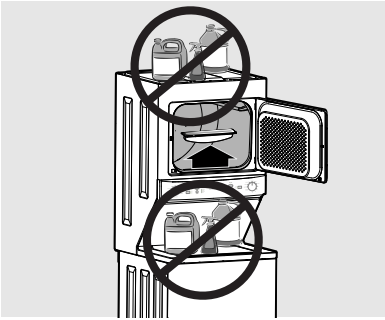

## IMPORTANT

DO NOT store or place laundry products on top of laundry center at any time. They can damage the finish or controls.

## Cleaning Outside of Laundry Center

- When washing is completed, wipe top and sides of laundry center with a damp cloth. Turn water faucets off to prevent pressure build-up in the hoses.
- Clean the cabinet with mild soap and water. Never use harsh, gritty or abrasive cleansers
- If the cabinet becomes stained, clean with diluted chlorine bleach (1 part bleach to 8 parts water). Rinse several times with clear water.
- When cleaning chrome parts, it is best to use only a damp cloth.

- Remove glue residue from tape or labels with a mixture of warm water and mild detergent. Or, touch residue with the sticky side of tape.
- Before moving the laundry center, place a strip of cardboard or thin fiberboard under the front leveling legs to prevent damage to the floor.

## Winterizing Instructions

### IMPORTANT

Winterize the laundry center if it is stored in an area where freezing can occur or moved in freezing temperatures to prevent damage to the washer:

1. Turn off water supply faucets.
2. Disconnect hoses from water supply and drain water from hoses.
3. Plug electrical cord into a properly grounded electrical outlet.
4. Add 1 gallon (3.8 L) nontoxic recreational vehicle (RV) antifreeze to empty wash drum. Close door.
5. Select rinse & spin cycle. Start cycle and let washer drain for 1 minute to drain out all water. Not all of the RV antifreeze will be expelled.
6. Stop the cycle, unplug electrical power cord, dry off tub interior, and close the lid.
7. Store laundry center in an upright position.
8. To remove antifreeze from washer after storage, run empty washer through a complete cycle using detergent. DO NOT add wash load.



Follow  
WINTERIZING  
INSTRUCTIONS  
for cold weather  
storage and care.



# Before Calling

Before calling for service, review this list. It may save both time and expense. The list includes common occurrences that are not the result of defective workmanship or materials in this laundry center.

Problem	Possible Causes	Solutions
<b>NOISE</b>		
Rattling and clanking noise	<ul style="list-style-type: none"> <li>Foreign objects such as coins or safety pins may be in drum or pump.</li> <li>Belt buckles and metal fasteners are hitting wash drum.</li> </ul>	<ul style="list-style-type: none"> <li>Stop washer and check drum. If noise continues after washer is restarted, objects may be in pump. Call an authorized service provider.</li> <li>To prevent unnecessary noise and damage to tub, fasten fasteners and turn items inside out.</li> </ul>
Thumping sound	<ul style="list-style-type: none"> <li>Heavy wash loads may produce a thumping sound. This is usually normal. If sound continues, washer may be out of balance.</li> </ul>	<ul style="list-style-type: none"> <li>Stop washer and redistribute wash load.</li> </ul>
Vibrating noise	<ul style="list-style-type: none"> <li>Washer is not resting firmly on floor.</li> <li>Wash load unevenly distributed in tub.</li> </ul>	<ul style="list-style-type: none"> <li>Move washer so it rests firmly on floor. Adjust leveling legs. See <i>Installation Instructions</i> for details.</li> <li>Stop washer and rearrange wash load.</li> </ul>
<b>OPERATING</b>		
Washer does not start	<ul style="list-style-type: none"> <li>Washer lid is open.</li> <li>Electrical power cord may not be plugged in or connection may be loose.</li> <li>House fuse blown, circuit breaker tripped, or a power outage has occurred.</li> <li>Water supply is not turned on.</li> <li>Motor is overheated. Washer motor will stop if it becomes overheated.</li> </ul>	<ul style="list-style-type: none"> <li>Close washer lid. Washer will not operate when the lid is open.</li> <li>Make sure plug fits tightly in wall outlet.</li> <li>Reset circuit breaker or replace fuse. DO NOT increase fuse capacity. If problem is a circuit overload, have it corrected by a qualified electrician. If problem is a power outage, call local electric company.</li> <li>Turn on water supply faucets.</li> <li>Wait for the motor to cool down before attempting to restart.</li> </ul>
Washer won't spin	<ul style="list-style-type: none"> <li>Lid is not completely closed.</li> </ul>	<ul style="list-style-type: none"> <li>Close washer lid. The washer will not operate when the lid is open.</li> </ul>
Residue left in drum	<ul style="list-style-type: none"> <li>Heavily soiled items.</li> </ul>	<ul style="list-style-type: none"> <li>Wipe drum with a nonabrasive household cleanser, then rinse. Shake or brush excess dirt and sand from items before washing.</li> </ul>
Dryer does not start	<ul style="list-style-type: none"> <li>Electrical power cord is not securely plugged in or plug may be loose.</li> <li>House fuse blown or circuit breaker tripped.</li> <li>Thermal limiter tripped.</li> </ul>	<ul style="list-style-type: none"> <li>Make sure the plug fits tightly in wall outlet.</li> <li>Reset circuit breaker or replace fuse.</li> <li>Make sure electrical line is not overloaded.</li> <li>Call authorized service person for replacement.</li> </ul>

# Before Calling

Problem	Possible Causes	Solutions
Dryer runs but won't heat	<ul style="list-style-type: none"> <li>• If 1 of the 2 fuses in the dryer circuit is blown, the drum may turn but the heater will not operate (electric models).</li> <li>• Gas supply valve is not open (gas models).</li> <li>• Dryer does not have enough air supply to support the burner flame (gas models).</li> <li>• LP gas supply tank is empty or there has been a utility interruption of natural gas (gas models).</li> </ul>	<ul style="list-style-type: none"> <li>• Replace fuse</li> <li>• Check to make sure supply valve is open. See <i>Installation Instructions</i> for procedure.</li> <li>• See <i>Installation Instructions</i>.</li> <li>• Refill or replace tank. Dryer should heat when utility service is restored.</li> </ul>
Drying cycle takes too long Outside of the dryer feels too hot or smells hot	<ul style="list-style-type: none"> <li>• Lint filter is clogged with lint.</li> <li>• Exhaust duct requirements have not been met.</li> <li>• Electric dryer is connected to a 208 volt circuit.</li> <li>• Drying procedures not followed.</li> <li>• Outside exhaust hood or exhaust duct may be clogged or restricted.</li> <li>• High humidity.</li> </ul>	<ul style="list-style-type: none"> <li>• Make sure all lint has been removed from the dryer lint filter before starting each cycle.</li> <li>• Exhaust duct must be at least 4 inches in diameter and made of rigid or semi-rigid metal.</li> <li>• When in place, the duct must have no more than four 90° bends and must not exceed length listed in <i>Installation Instructions</i>.</li> <li>• Drying time will be 20% longer than drying on a 240 volt circuit.</li> <li>• See <i>Operating Instructions</i></li> <li>• Clean out any obstruction.</li> <li>• Use a dehumidifier near the dryer.</li> </ul>
Excessive wrinkling	<ul style="list-style-type: none"> <li>• Dryer is overloaded.</li> <li>• Items left in dryer too long.</li> <li>• Insufficient sorting of items.</li> <li>• Drying temperature too high.</li> </ul>	<ul style="list-style-type: none"> <li>• DO NOT overload. See <i>Operating Instructions</i>.</li> <li>• Remove items as soon as cycle ends.</li> <li>• See <i>Operating Instructions</i>.</li> <li>• Follow fabric care label instructions.</li> </ul>
Scratching or chipping of the drum finish	<ul style="list-style-type: none"> <li>• Foreign objects such as coins, pins, clips or buttons are inside the dryer.*</li> <li>• Permanently attached items such as belt buckles, zippers, and fasteners may be hitting the inside of the drum.*</li> </ul>	<ul style="list-style-type: none"> <li>• Always remove foreign objects from pockets before laundering. Remove objects from drum and restart dryer.</li> <li>• Turn items inside out before drying to prevent scratching and damage to the dryer.</li> </ul>
*Drum damage caused by foreign objects or permanently attached items is not covered by the warranty.		
<b>WATER</b>		
Wash load too wet after spin	<ul style="list-style-type: none"> <li>• Washer is overloaded.</li> <li>• Load is out of balance.</li> <li>• Drain hose is kinked.</li> </ul>	<ul style="list-style-type: none"> <li>• DO NOT overload washer. See <i>Operating Instructions</i>.</li> <li>• Rearrange load to allow proper spinning.</li> <li>• Straighten drain hose.</li> </ul>

# Before Calling

Problem	Possible Causes	Solutions
WATER (continued)		
Water does not enter washer or it enters slowly	<ul style="list-style-type: none"> <li>Washer lid is open.</li> <li>Water supply is not adequate in area.</li> <li>Water supply faucets are not completely open.</li> <li>Water is being used elsewhere in the house.</li> <li>Water inlet hoses are kinked.</li> </ul>	<ul style="list-style-type: none"> <li>Close washer lid. The washer will not operate when the lid is open.</li> <li>Check other faucets in the house. Wait until water supply and pressure increase.</li> <li>Fully open hot and cold faucets.</li> <li>Water pressure must be at least 10 psi (69 kPa). Avoid running water elsewhere while washer is filling.</li> <li>Straighten hoses.</li> </ul>
Warm or hot water is not hot enough	<ul style="list-style-type: none"> <li>Hot water heater is set too low or is a distance from washer.</li> <li>Hot water is being used elsewhere in the house.</li> </ul>	<ul style="list-style-type: none"> <li>Measure hot water temperature at nearby faucet with candy or meat thermometer. Water temperature should be at least 120°F (50°C). Adjust water heater as necessary.</li> <li>Avoid using hot water elsewhere before or during washer use. There may not be enough hot water available for proper cleaning. If problem persists, hot water system may be unable to support more than 1 use at a time.</li> </ul>
Water in washer does not drain or drains slowly	<ul style="list-style-type: none"> <li>Drain hose is kinked or clogged.</li> </ul>	<ul style="list-style-type: none"> <li>Clean and straighten the drain hose.</li> </ul>
Water leaks	<ul style="list-style-type: none"> <li>Loose fill hose connection at faucet or washer.</li> <li>House drain pipes are clogged.</li> </ul>	<ul style="list-style-type: none"> <li>Check and tighten hose connections. Install rubber sealing washers provided.</li> <li>Unclog drain pipes. Contact plumber if necessary.</li> </ul>
Incorrect wash and rinse temperatures	<ul style="list-style-type: none"> <li>Hot and cold water hoses are connected to wrong supply faucets.</li> </ul>	<ul style="list-style-type: none"> <li>Connect hot water hose to hot water faucet and cold water hose to cold water faucet.</li> </ul>
Water enters washer but tub does not fill	<ul style="list-style-type: none"> <li>Drain hose standpipe is incorrect height.</li> </ul>	<ul style="list-style-type: none"> <li>Standpipe must be a minimum of 33" (84 cm) high to prevent siphoning. See <i>Installation Instructions</i>.</li> </ul>
Water is present in tub after wash cycle is complete	<ul style="list-style-type: none"> <li>Lid lock malfunction.</li> </ul>	<ul style="list-style-type: none"> <li>DO NOT bypass lid lock. Call an authorized service provider.</li> </ul>
The drain and spin cycles did not occur	<ul style="list-style-type: none"> <li>Lid lock malfunction.</li> </ul>	<ul style="list-style-type: none"> <li>DO NOT bypass lid lock. Call an authorized service provider.</li> </ul>

# Kenmore®

## Customer Care Hotline

To schedule in-home repair service  
or order replacement parts

Para pedir servicio de reparación  
a domicilio, y ordenar piezas

# 1-844-553-6667

[www.kenmore.com](http://www.kenmore.com)

