

# **VEVOR<sup>®</sup>**

**TOUGH TOOLS, HALF PRICE**

Technical Support and E-Warranty Certificate [www.vevor.com/support](http://www.vevor.com/support)

## **BOX STYLE CAT TREES USER MANUAL**

We continue to be committed to provide you tools with competitive price.

"Save Half", "Half Price" or any other similar expressions used by us only represents an estimate of savings you might benefit from buying certain tools with us compared to the major top brands and does not necessarily mean to cover all categories of tools offered by us. You are kindly reminded to verify carefully when you are placing an order with us if you are actually saving half in comparison with the top major brands.



# VEVOR®

TOUGH TOOLS, HALF PRICE

## BOX STYLE CAT TREES

MODEL:SSXG003

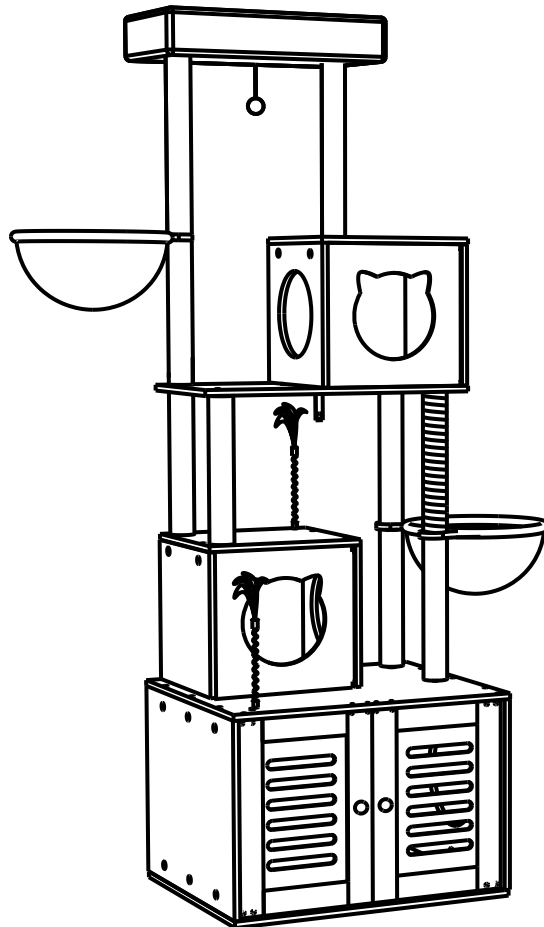

### NEED HELP? CONTACT US!

Have product questions? Need technical support? Please feel free to contact us: Technical Support and E-Warranty Certificate [www.vevor.com/support](http://www.vevor.com/support)

This is the original instruction, please read all manual instructions carefully before operating. VEVOR reserves a clear interpretation of our user manual. The appearance of the product shall be subject to the product you received. Please forgive us that we won't inform you again if there are any technology or software updates on our product.

## **SAFETY INSTRUCTIONS**

### **WARNING:**

**Read this material before using this product. Failure to do so can result in serious injury.**

### **Assembly precautions**

1. Assemble only according to these instructions. Improper assembly can create hazards.
2. Wear ANSI-approved safety goggles and heavy-duty work gloves during assembly.
3. Keep the assembly area clean and well-lit.
4. Keep bystanders out of the area during assembly.
5. Do not assemble if tired or when under the influence of alcohol, drugs or medication.
6. The product capabilities apply to properly and completely assembled products only.
7. Assemble on a flat, level, hard and smooth surface capable of safely supporting the Box Style Cat Trees.
8. For additional information regarding the parts listed in the following pages, please refer to the Assembly Diagram of this manual. Unwrap and separate all parts in a clean work area.

### **Use precautions**

1. **DO NOT SIT OR STAND ON THIS ITEM.**
2. This product is not a toy. Do not allow children to play with or near this item.
3. Do not exceed specified weight capacities.
4. Use only on a flat, level, hard, and smooth surface that can safely support a fully loaded Box Style Cat Trees.
5. Use as intended only.
6. Inspect before every use; do not use if parts are loose or damaged.

### **SAVE THIS MANUAL**



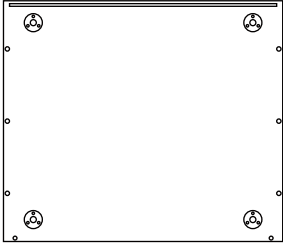
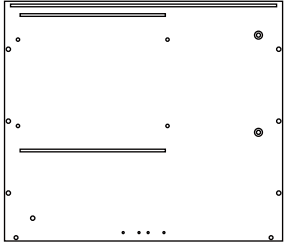
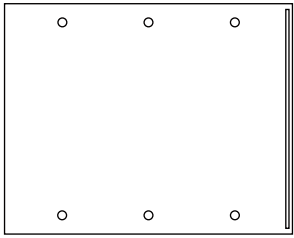
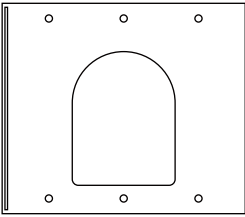
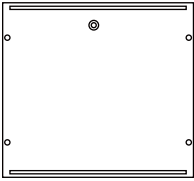
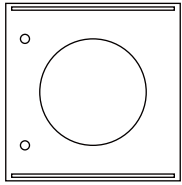
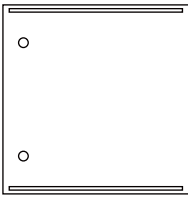
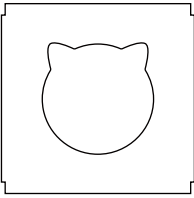
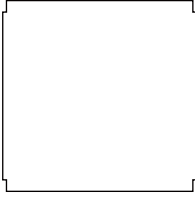
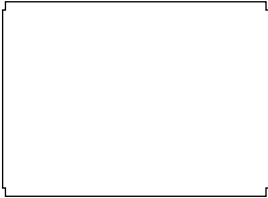
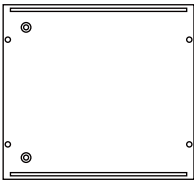
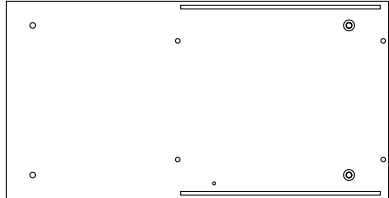
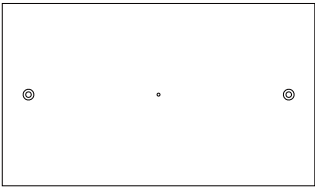
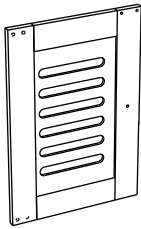
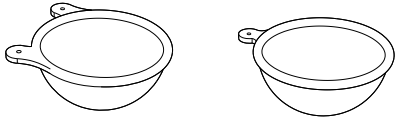









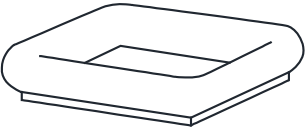
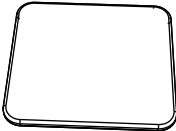

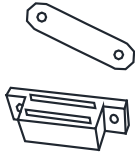
# Accessories table

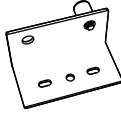
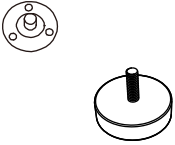
 <p>A×1</p>	 <p>B×1</p>	 <p>C×1</p>
 <p>D×1</p>	 <p>E×1</p>	 <p>F×2</p>
 <p>G×2</p>	 <p>H×2</p>	 <p>I×2</p>
 <p>J×1</p>	 <p>K×1</p>	 <p>L×1</p>
 <p>M×1</p>	 <p>N×2</p>	 <p>O1×1      O2×1</p>



\*Each set comes with a screwdriver and wrench

# Accessories table

<p>(Sisal columns) 30cm</p>  <p>① × 1</p>	<p>(Wrap the column) 30cm</p>  <p>② × 6</p>	<p>37cm</p>  <p>③ × 2</p>
<p>(cushion)</p>  <p>④ × 1</p>	<p>(cushion)</p>  <p>⑤ × 2</p>	<p>(Spring toys)</p>  <p>S × 2</p>
<p>(doorknob) (Door stopper)</p>  <p>U × 2</p>  <p>V × 2</p>	<p>(Furball toys) (Anti-tipping rope)</p>  <p>X × 1</p>  <p>W × 1</p>	<p>(Rotating shaft)</p>  <p>Y × 4</p>
<p>(Adjustable footrest)</p>  <p>Z × 4</p>	<p>(3-in-1 screws)</p>  <p>Q1 × 20</p>	<p>(M6*40) (M4*22)</p>  <p>Q2 × 8</p>  <p>Q3 × 2</p>
<p>(M4*12)</p>  <p>T1 × 12</p>	<p>(M8*30)</p>  <p>T2 × 10</p>	<p>(M8*70) (M3*12)</p>  <p>T3 × 4</p>  <p>T4 × 16</p>

# Installation Steps

## Step 1

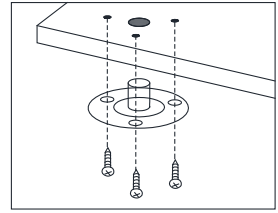
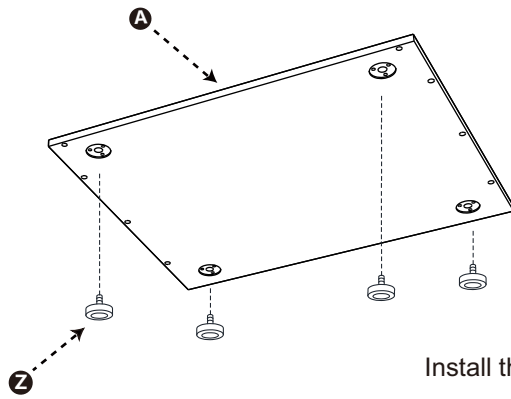

Install the adjustable foot pad on the base as illustrated;

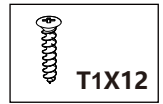
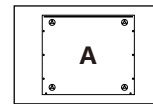

## Step 2

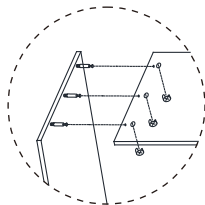

The three-in-one screw installation method is shown in the figure;;

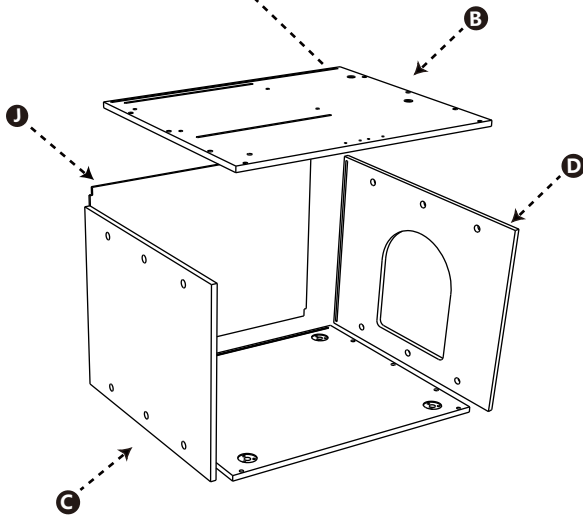

Assemble the bottom cabinet first as shown in the figure;

(Note: Align the holes before tightening)

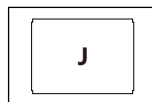
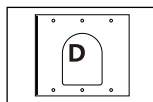
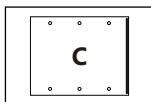
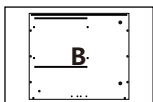

## Step 3

As shown in the figure, assemble the corresponding door stopper and the small black nose U;

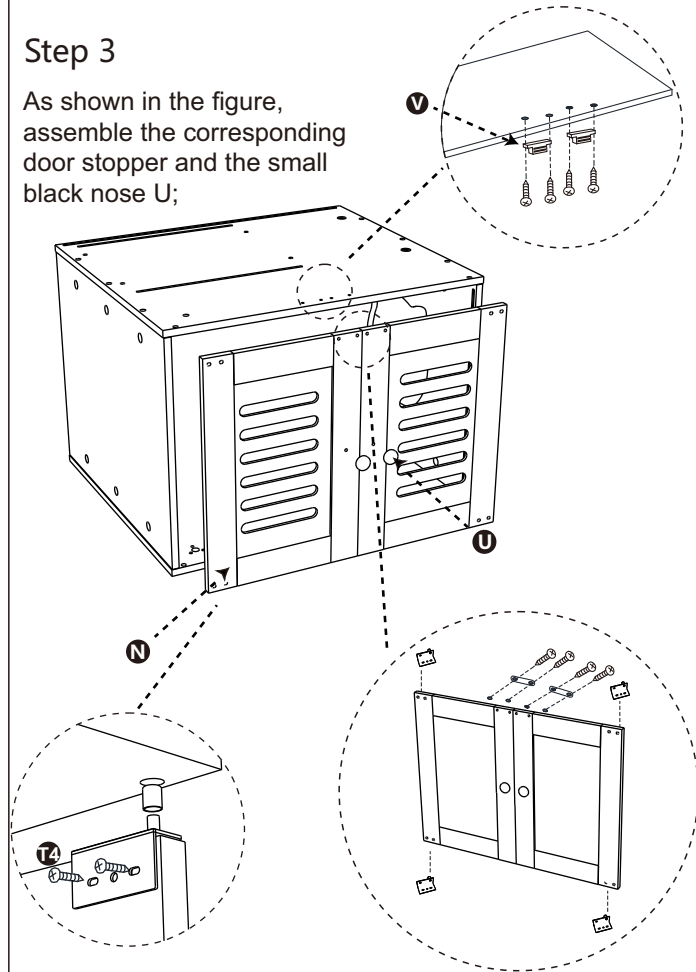

Put the spindle plate first, and then put the hinge Place on the door and tighten the screws;

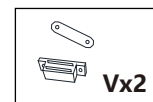
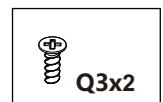

## Step 4

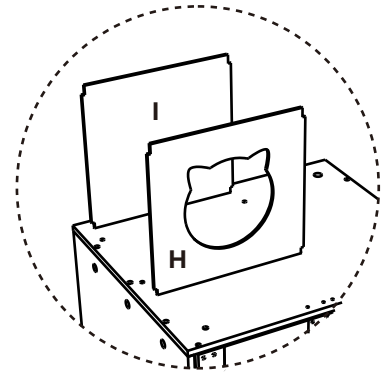
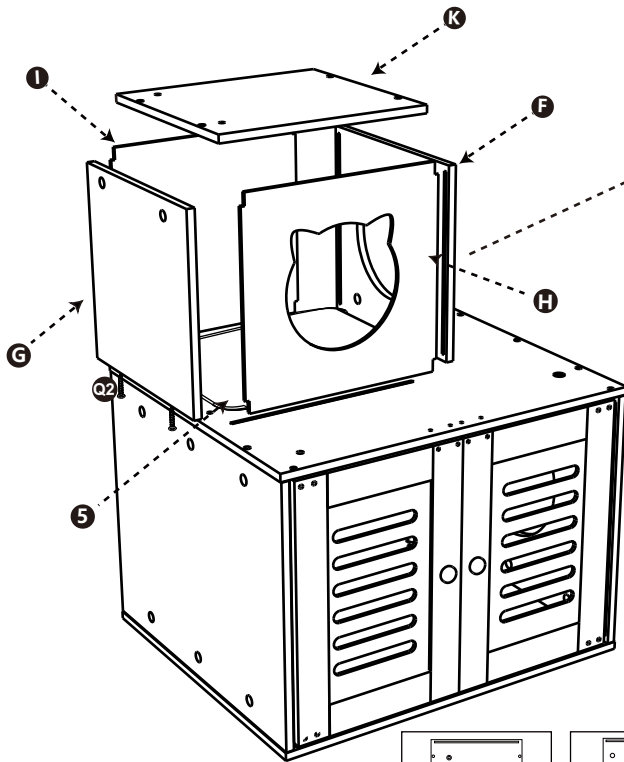

Insert the I plate and H plate into the top groove of the cabinet;

Assemble the cat nest above the cabinet as shown in the figure, and finally put the mat 5 on;

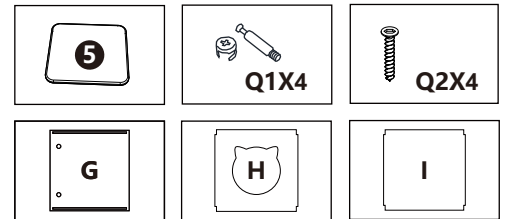

## Step 5

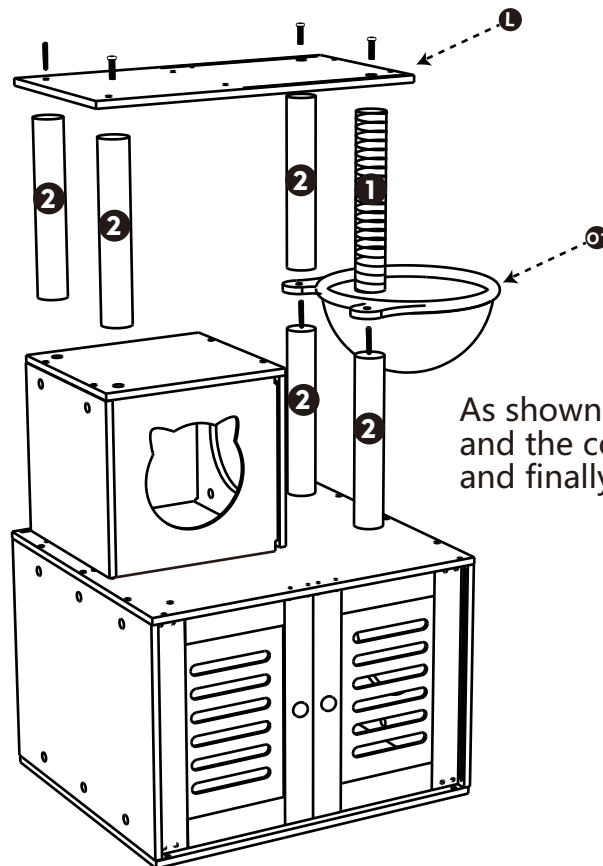

As shown in the figure, the hammock O1 and the corresponding column are installed, and finally the wooden board L is installed;

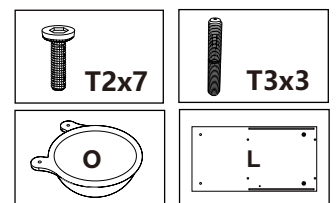

## Step 6

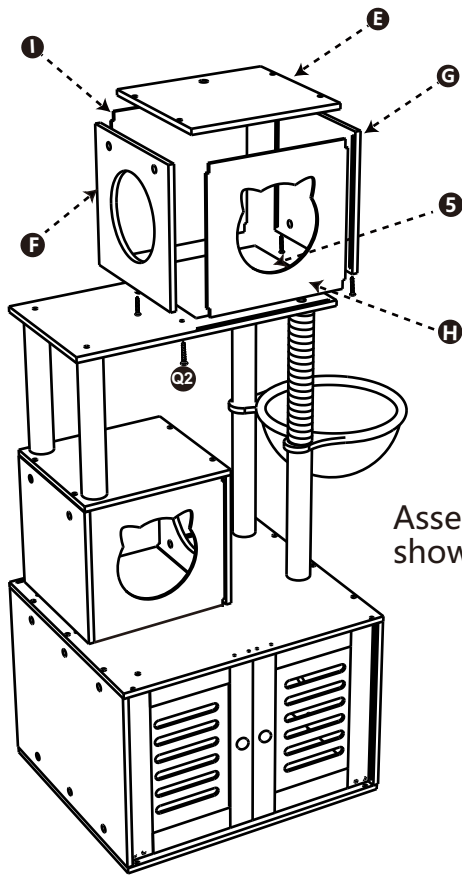

Assemble another cat nest on the cabinet as shown in the figure, and finally put the mat 5 into it;

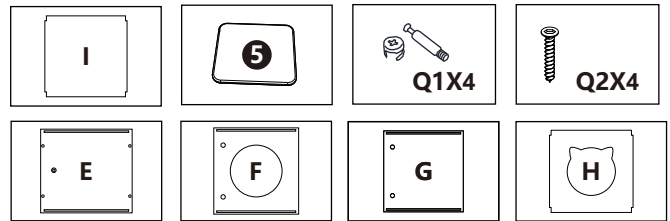

## Step 7

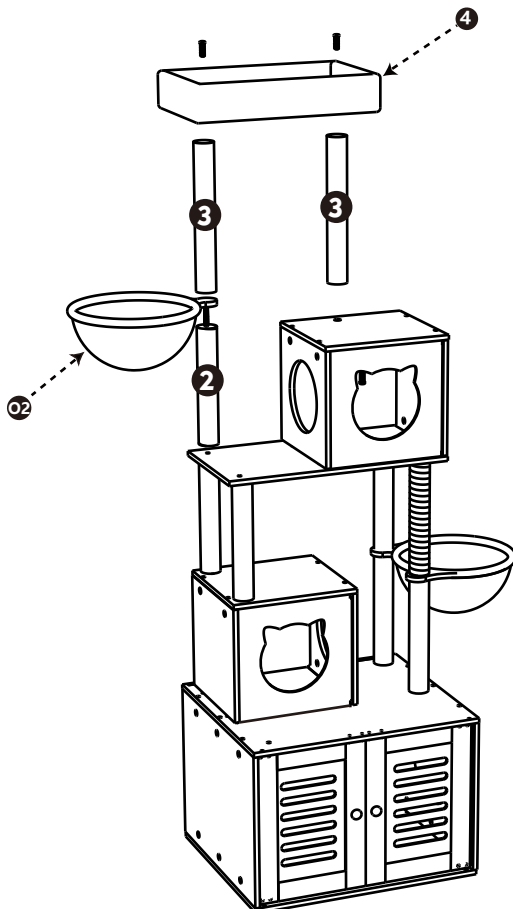

As shown in the figure, the hammock O2 and the corresponding column are installed, and finally the mat 4 is installed;

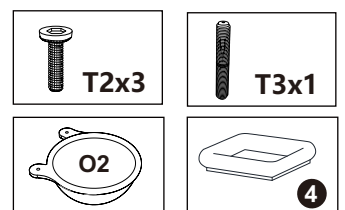

## Step 8

Plug the expansion pipe into the wall, and then fix the anti-tipping rope on the wall with self-tapping wire; Finally, use screws to fix the other side to the cat climbing frame.

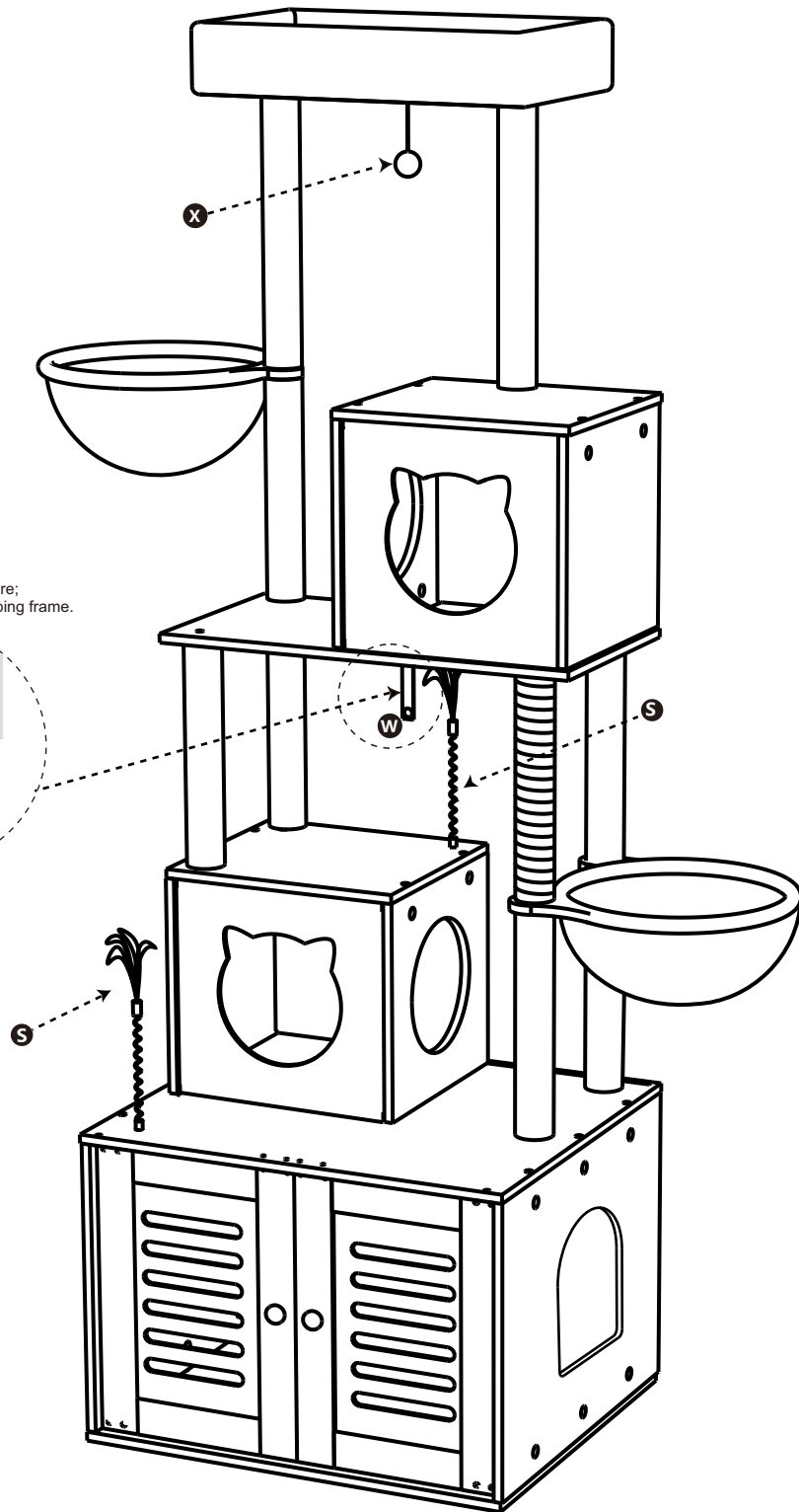
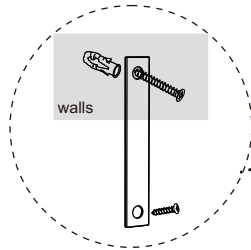

Install the hairball toy and spring toy as shown in the picture, and finally tighten it so that the screws can be fixed.

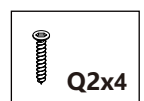
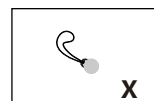

## PRODUCT PARAMETER

<b>Model</b>	SSXG003
<b>Colour</b>	Gray
<b>Product Size</b>	600*520*1850mm

**Manufacturer:** Shanghaimuxinmuyeyouxiangongsi

**Address:** Shuangchenglu 803nong11hao1602A-1609shi, baoshanqu, shanghai 200000 CN.

**Imported to AUS:** SIHAO PTY LTD. 1 ROKEVA STREETEASTWOOD NSW 2122 Australia

**Imported to USA:** Sanven Technology Ltd. Suite 250, 9166 Anaheim Place, Rancho Cucamonga, CA 91730

<b>EC</b>	<b>REP</b>
-----------	------------

E-CrossStu GmbH  
Mainzer Landstr.69, 60329 Frankfurt am Main.

<b>UK</b>	<b>REP</b>
-----------	------------

YH CONSULTING LIMITED.  
C/O YH Consulting Limited Office 147, Centurion House, London Road, Staines-upon-Thames, Surrey, TW18 4AX

**VEVOR<sup>®</sup>**  
**TOUGH TOOLS, HALF PRICE**

**Technical Support and E-Warranty Certificate**  
**[www.vevor.com/support](http://www.vevor.com/support)**



# **VEVOR<sup>®</sup>**

## **TOUGH TOOLS, HALF PRICE**

Supporto tecnico e certificato di garanzia elettronica [www.vevor.com/support](http://www.vevor.com/support)

### **ALBERI PER TIRAGRAFFI A SCATOLA**

### **MANUALE D'USO**

Continuiamo a impegnarci per fornirvi strumenti a prezzi competitivi.

"Risparmia la metà", "Metà prezzo" o qualsiasi altra espressione simile da noi utilizzata rappresenta solo una stima del risparmio che potresti ottenere acquistando determinati utensili con noi rispetto ai principali marchi principali e non significa necessariamente coprire tutte le categorie di utensili da noi offerti. Ti ricordiamo gentilmente di verificare attentamente quando effettui un ordine con noi se stai effettivamente risparmiando la metà rispetto ai principali marchi principali.



**VEVOR**<sup>®</sup>  
TOUGH TOOLS, HALF PRICE

ALBERI PER TIRAGRAFFI A SCATOLA

MODELLO:SSXG003

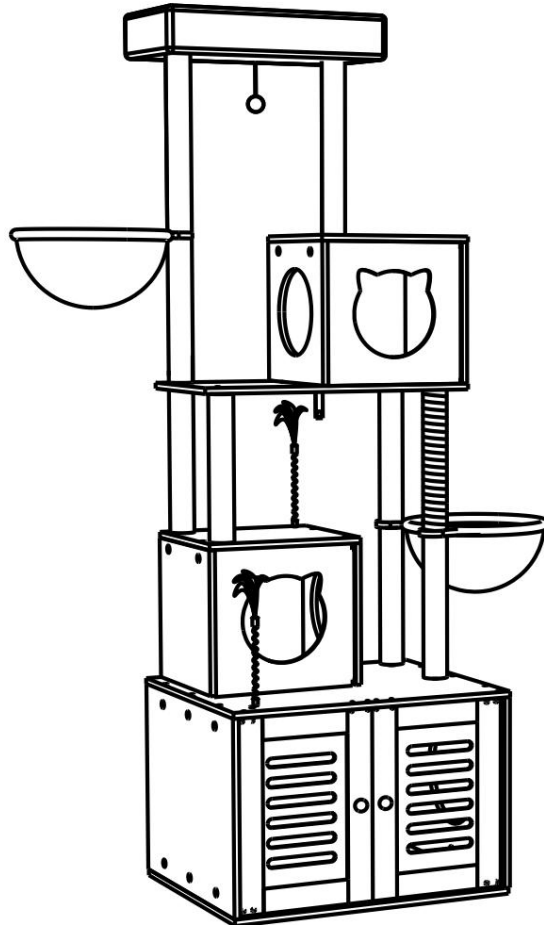

**HAI BISOGNO DI AIUTO? CONTATTACI!**

Hai domande sul prodotto? Hai bisogno di supporto tecnico? Non esitare a contattarci: Supporto tecnico e certificato di garanzia elettronica [www.vevor.com/support](http://www.vevor.com/support)

Questa è l'istruzione originale, si prega di leggere attentamente tutte le istruzioni del manuale prima di utilizzare. VEVOR si riserva una chiara interpretazione del nostro manuale utente. L'aspetto del prodotto sarà soggetto al prodotto ricevuto. Vi preghiamo di perdonarci se non vi informeremo di nuovo se ci sono aggiornamenti tecnologici o software sul nostro prodotto.

## ISTRUZIONI DI SICUREZZA

### AVVERTIMENTO:

**Leggere questo materiale prima di utilizzare questo prodotto. La mancata osservanza di questa precauzione può causare gravi lesioni.**

### Precauzioni di montaggio 1.

Montare solo secondo queste istruzioni. Un montaggio non corretto può creare pericoli.

2. Durante il montaggio, indossare occhiali di sicurezza omologati ANSI e guanti da lavoro resistenti.

3. Mantenere l'area di assemblaggio pulita e ben illuminata.

4. Tenere gli astanti fuori dall'area durante l'assemblea.

5. Non presentarsi se si è stanchi o sotto l'effetto di alcol, droghe o farmaci.

6. Le capacità del prodotto si applicano solo ai prodotti correttamente e completamente assemblati.

7. Montare su una superficie piana, livellata, dura e liscia in grado di sostenere in modo sicuro a sostegno dei tiragraffi Box Style.

8. Per ulteriori informazioni sulle parti elencate di seguito pagine, fare riferimento allo schema di montaggio di questo manuale. Disimballare e separare tutte le parti in un'area di lavoro pulita.

### Usare precauzioni 1.

**NON SEDERSI O STARE IN PIEDI SU QUESTO ARTICOLO.**

2. Questo prodotto non è un giocattolo. Non permettere ai bambini di giocare con o vicino a questo articolo.

3. Non superare le capacità di peso specificate.



4. Utilizzare solo su una superficie piana, livellata, dura e liscia che possa essere utilizzata in sicurezza supportare un tiragraffi stile scatola completamente attrezzato.

5. Utilizzare solo come previsto.





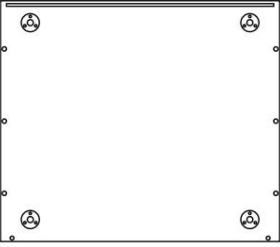
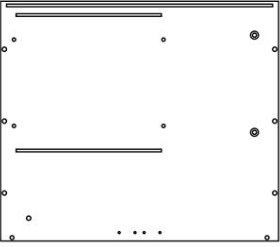
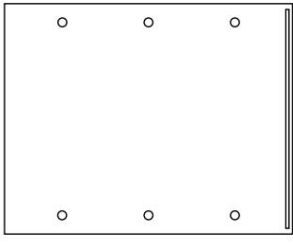
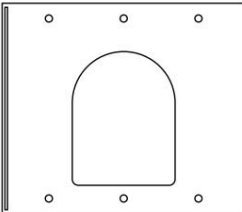
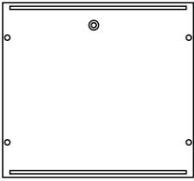
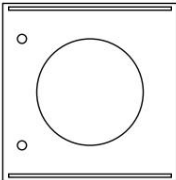
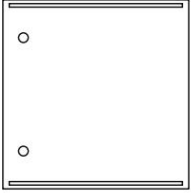
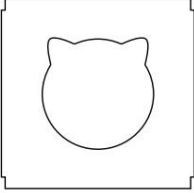
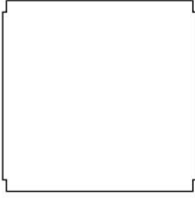
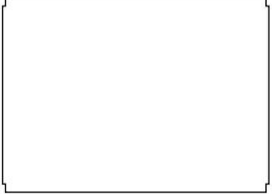
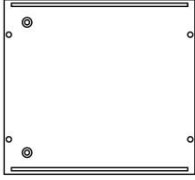
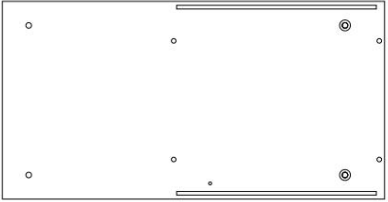
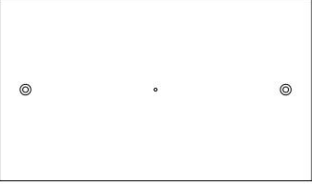
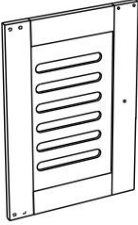
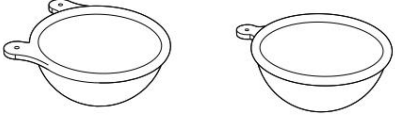











6. Ispezionare prima di ogni utilizzo; non utilizzare se alcune parti sono allentate o danneggiate.

**SALVA QUESTO MANUALE**

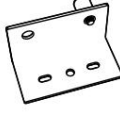
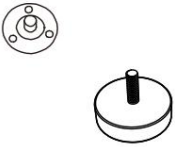
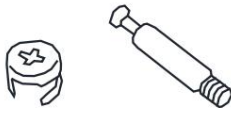
## Tabella degli accessori

 <p>Lax1</p>	 <p>Bx1</p>	 <p>Cx1</p>
 <p>La x 1</p>	 <p>Ex1</p>	 <p>Fx2</p>
 <p>Solx2</p>	 <p>Altezzax2</p>	 <p>lox2</p>
 <p>Numero di serie 1</p>	 <p>Kx1</p>	 <p>Lx1</p>
 <p>Mx1</p>	 <p>Numero 2</p>	 <p>O1x1      O2x1</p>
 *Ogni set è dotato di cacciavite e chiave inglese		

## Tabella degli accessori

<p>(Colonne in sisal) 30cm</p>  <p>1 x1</p>	<p>(Avvolgi la colonna) 30 centimetri</p>  <p>2 x6</p>	<p>37 centimetri</p>  <p>3 x2</p>
<p>(cuscino)</p>  <p>4 x1</p>	<p>(cuscino)</p>  <p>5 x2</p>	<p>(Giocattoli a molla)</p>  <p>Sx2</p>
<p>(maniglia della porta) (Fermaporta) (Giocattoli di pelo) (Corda antiribaltamento) (Albero rotante)</p>		
<p>Ux2</p>  <p>Vx2</p> 	<p>Xx1</p>  <p>Lx1</p> 	<p>Yx4</p> 
<p>(Poggiapiedi regolabile)</p>  <p>Zx4</p>	<p>(viti 3 in 1)</p>  <p>Q1x20</p>	<p>(M6*40)</p>  <p>Q2x8</p> <p>(M4*22)</p>  <p>Q3x2</p>
<p>(M4*12)</p>  <p>T1 x12</p>	<p>(M8*30)</p>  <p>T2 x10</p>	<p>(M8*70)</p>  <p>T3 x4</p> <p>(M3*12)</p>  <p>T4 x16</p>

# Fasi di installazione

## Passo 1

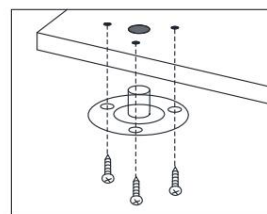
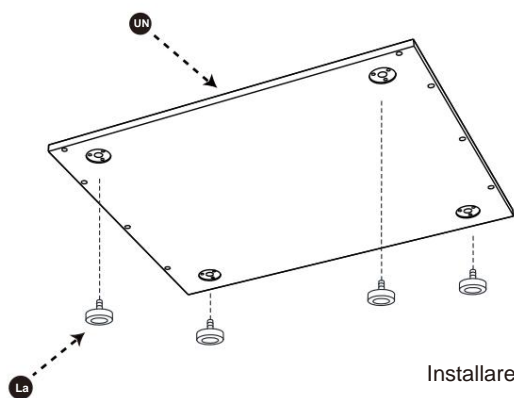

Installare il piedino regolabile sulla base come illustrato;

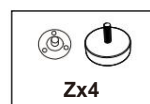
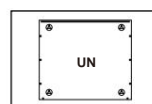

## Passo 2

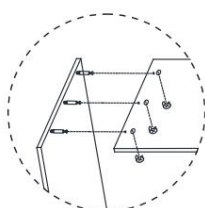

Nella figura è illustrato il metodo di installazione delle viti tre in uno;

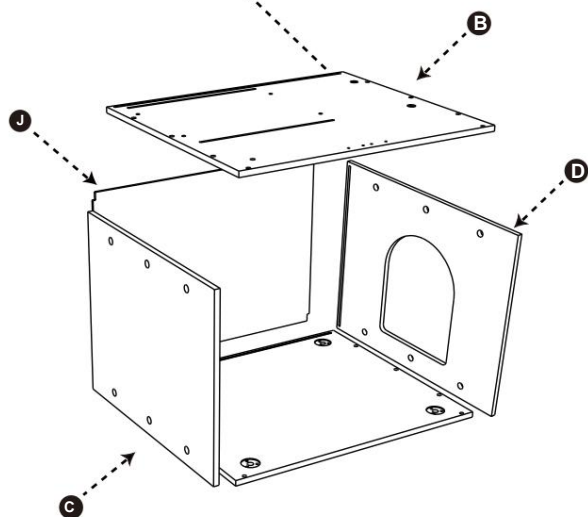

Montare prima il mobile inferiore come mostrato in figura;

(Nota: allineare i fori prima di serrare)

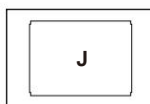
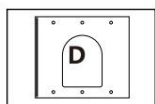
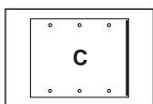
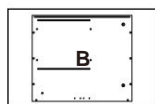

## Passo 3

Come mostrato in figura, assemblare il fermaporta corrispondente e il piccolo naso nero U;

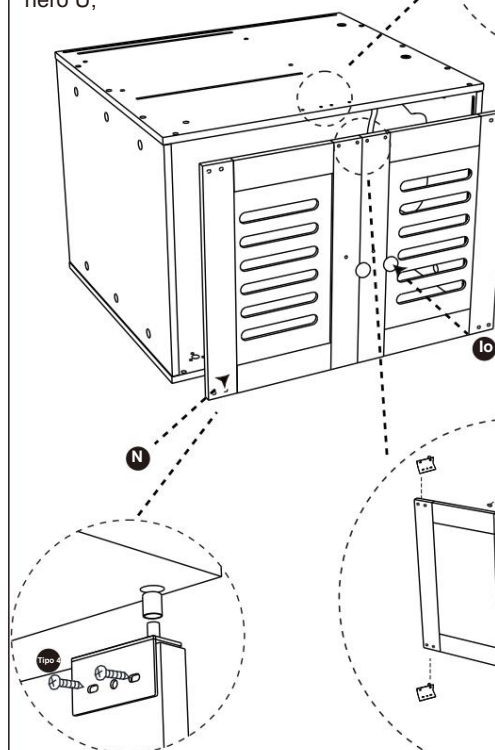
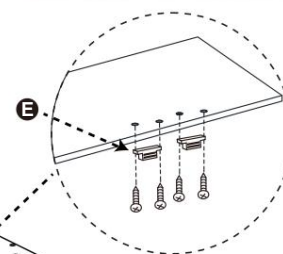

Mettere prima la piastra del mandrino e poi mettere la cerniera. Posizionare sulla porta e stringere le viti;



Passo 4

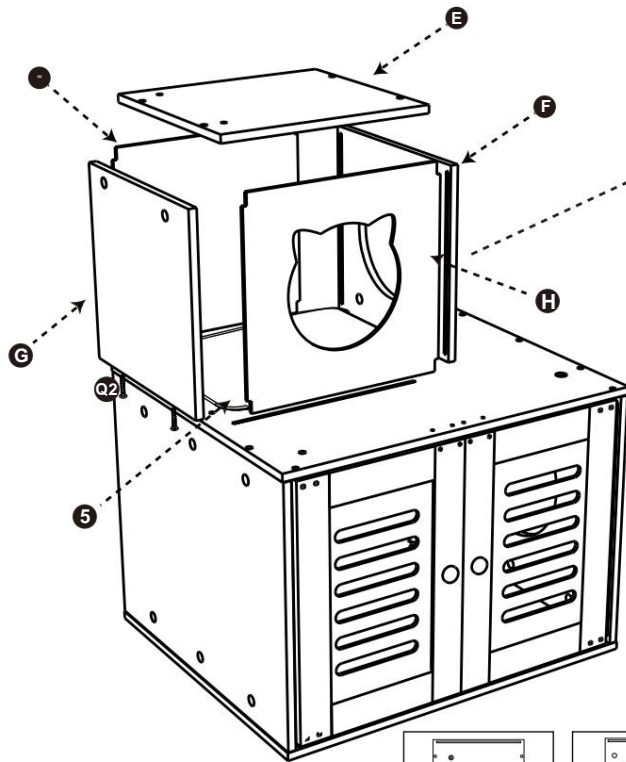

Inserire la piastra I e la piastra H nella scanalatura superiore del mobile;

Montare la cuccia per gatti sopra il mobile come mostrato in figura e infine posizionare il tappetino 5;

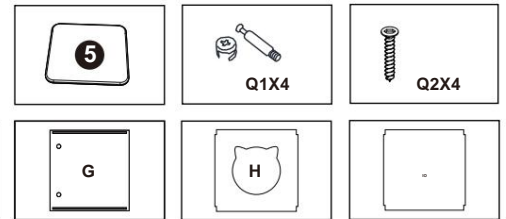

Passo 5

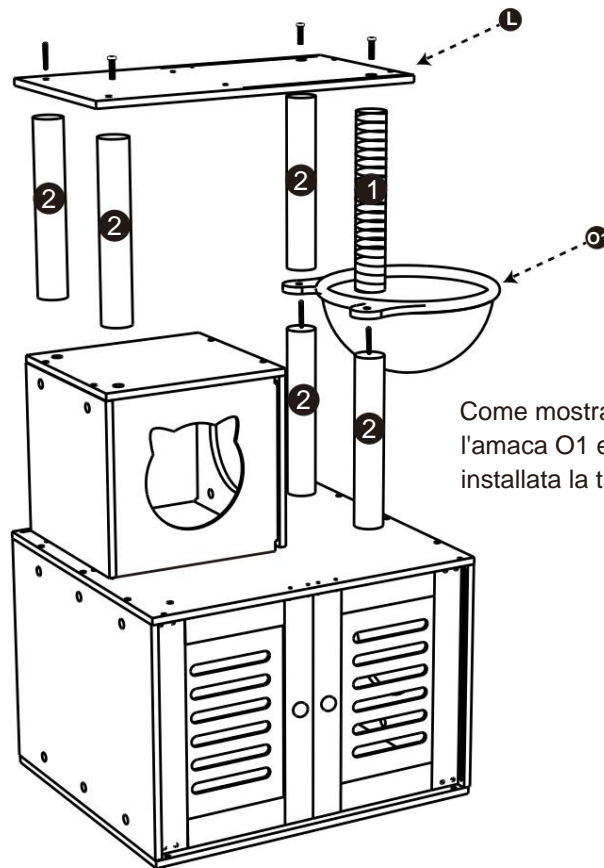

Come mostrato nella figura, vengono installate l'amaca O1 e la colonna corrispondente e infine viene installata la tavola di legno L;

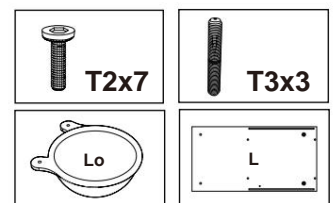

Passo 6

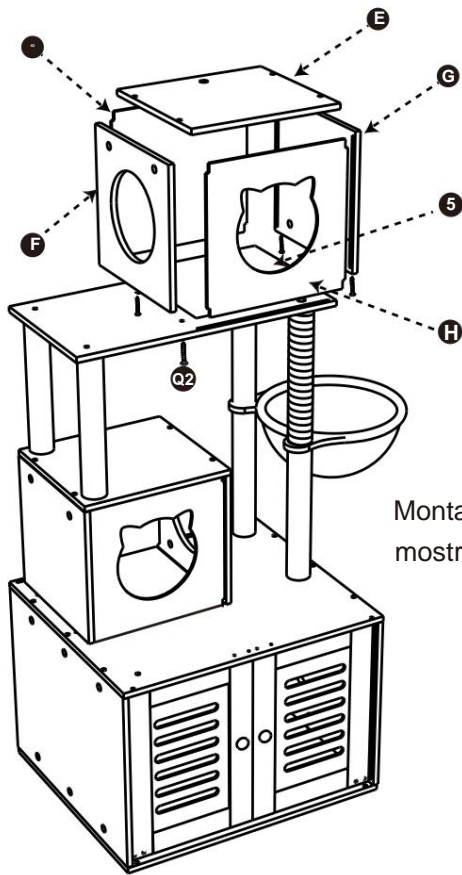

Montare un altro nido per gatti sul mobile come mostrato in figura e infine posizionare al suo interno il tappetino 5;

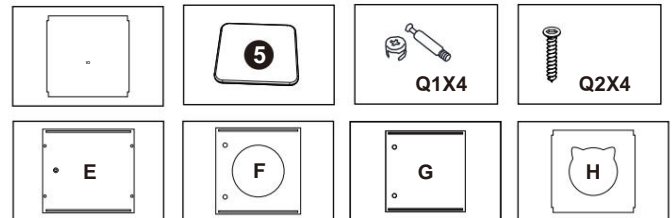

Passo 7

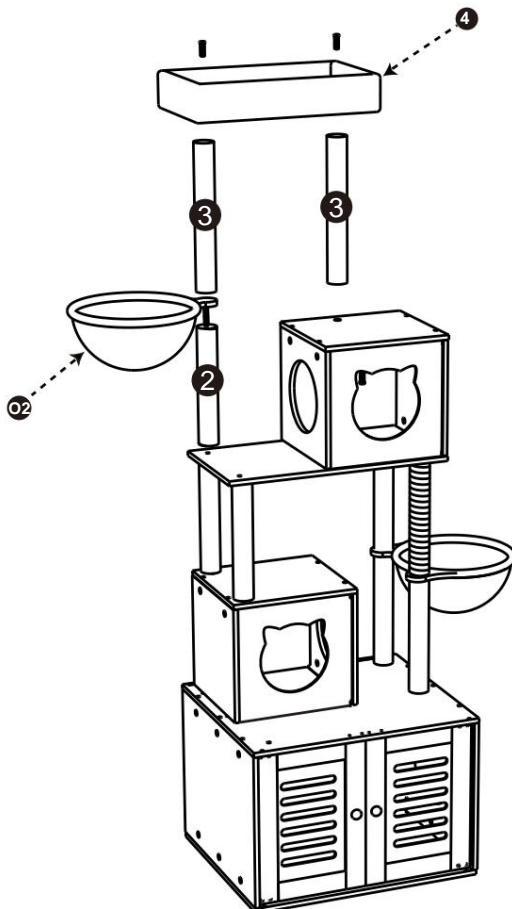

Come mostrato in figura, vengono installate l'amaca O2 e la relativa colonna, e infine viene installato il materassino 4;

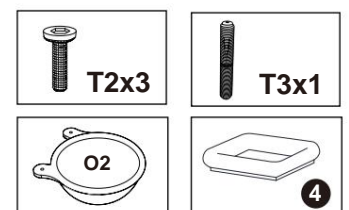

## Passo 8

Collegare il tubo di espansione al muro, quindi fissare la corda antiribaltamento al muro con del filo autofilettante; infine, utilizzare delle viti per fissare l'altro lato alla struttura per arrampicarsi sui gatti.

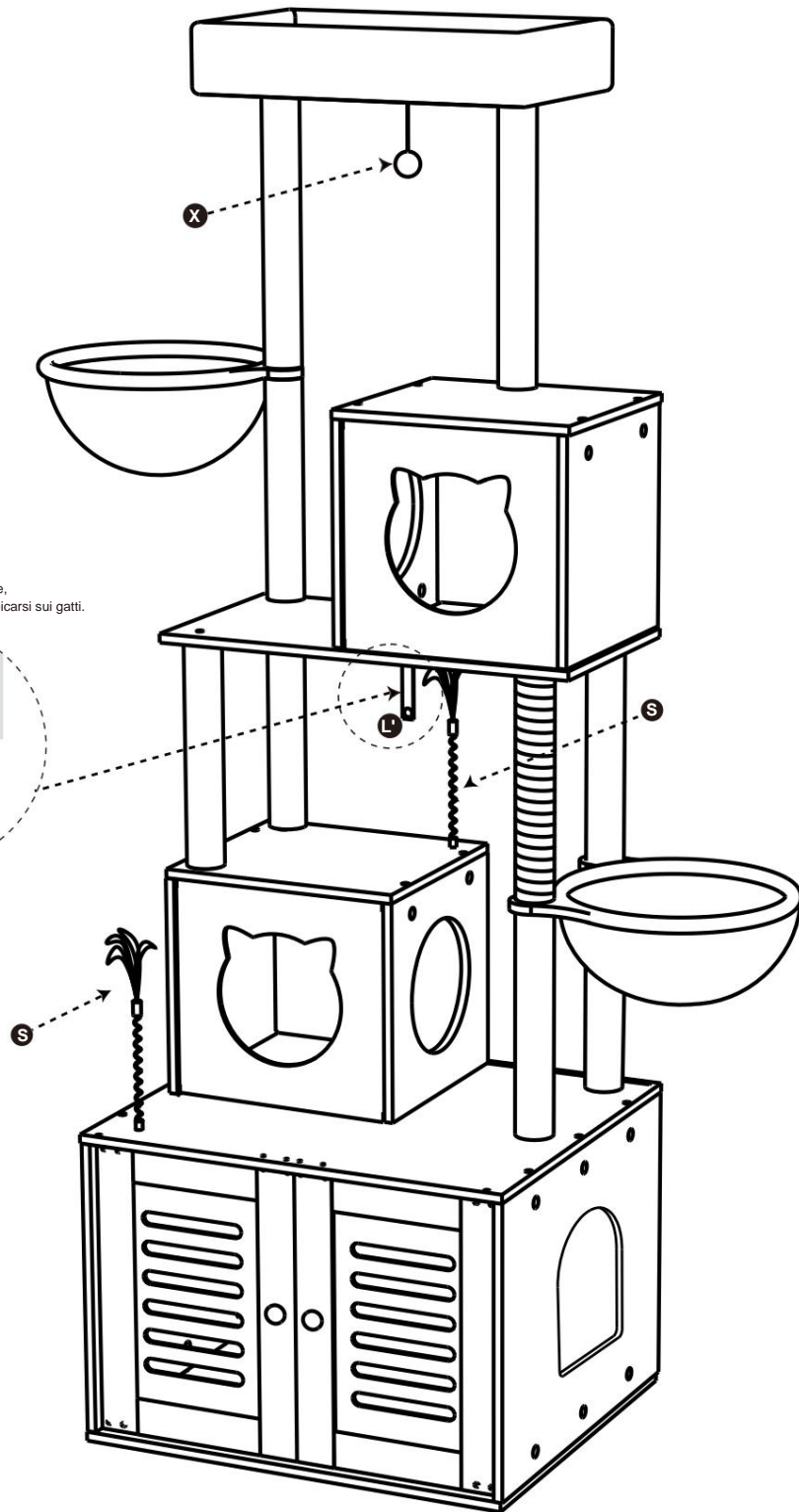
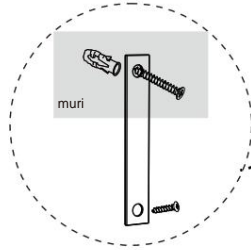

Installare il giocattolo a forma di palla di pelo e il giocattolo a molla come mostrato nell'immagine e infine stringere in modo che le viti possano essere fissate.

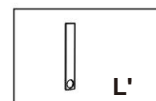
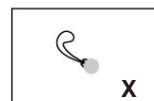

## PARAMETRO PRODOTTO

<b>Modello</b>	SSXG003
<b>Colore</b>	Grigio
<b>Dimensioni del prodotto</b>	600*520*1850mm

**Produttore:** Shanghaimuxinmuyeyouxiangongsi **Indirizzo:**

Shuangchenglu 803nong11hao1602A-1609shi, baoshanqu, shanghai 200000 CN.

**Importato in AUS:** SIHAO PTY LTD. 1 ROKEVA STREETEASTWOOD NSW 2122  
Australia

**Importato negli USA:** Sanven Technology Ltd. Suite 250, 9166 Anaheim Place, Rancho  
Cucamonga, CA 91730

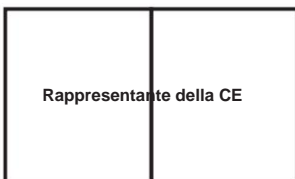

E-CrossStu GmbH

Mainzer Landstr.69, 60329 Francoforte sul Meno.



CONSULENZA YH LIMITATA.

C/O YH Consulting Limited Ufficio 147, Centurion

Casa, London Road, Staines-upon-Thames, Surrey,

Modello TW18 4AX

**VEVOR<sup>®</sup>**  
**TOUGH TOOLS, HALF PRICE**

Supporto tecnico e certificato di garanzia  
elettronica [www.vevor.com/support](http://www.vevor.com/support)



# VEVOR®

## TOUGH TOOLS, HALF PRICE

Wsparcie techniczne i certyfikat gwarancji elektronicznej [www.vevor.com/support](http://www.vevor.com/support)

DRZEWA DLA KOTA W STYLU PUDEŁKOWYM

INSTRUKCJA OBSŁUGI

Nadal staramy się oferować Państwu narzędzia w konkurencyjnych cenach.

„Oszczędź połowę”, „Połowa ceny” lub inne podobne wyrażenia używane przez nas stanowią jedynie szacunkowe oszczędności, jakie możesz uzyskać, kupując u nas określone narzędzia w porównaniu z głównymi markami i niekoniecznie oznaczają one objęcie wszystkich kategorii narzędzi oferowanych przez nas. Uprzejmie przypominamy, aby dokładnie sprawdzić, czy składając u nas zamówienie faktycznie oszczędzasz połowę w porównaniu z głównymi markami.



# VEVOR®

TOUGH TOOLS, HALF PRICE

DRZEWA DLA KOTA W STYLU PUDEŁKOWYM

MODEL:SSXG003

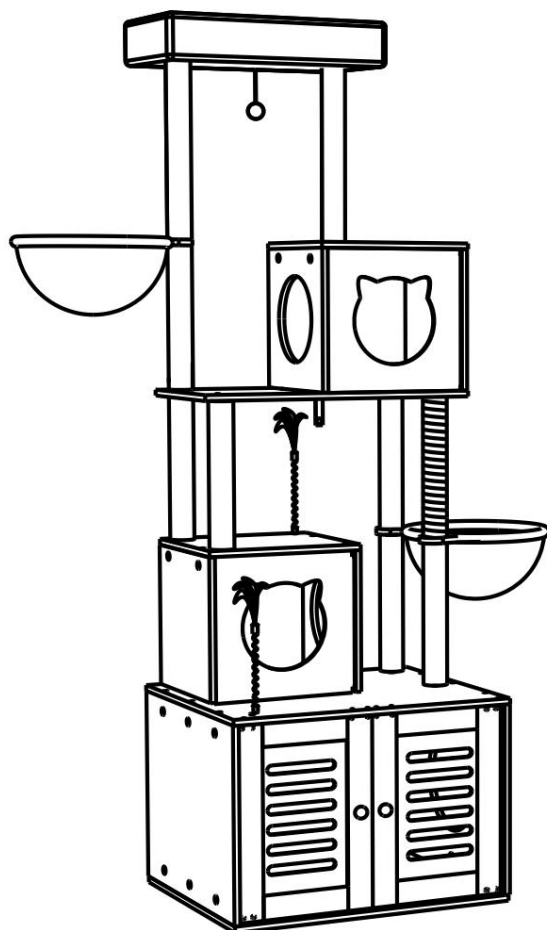

POTRZEBUJESZ POMOCY? SKONTAKTUJ SIĘ Z NAMI!!

Masz pytania dotyczące produktu? Potrzebujesz wsparcia technicznego? Skontaktuj się z nami: Wsparcie techniczne i certyfikat E-Gwarancji [www.vevor.com/support](http://www.vevor.com/support)

To jest oryginalna instrukcja, przed użyciem należy uważnie przeczytać wszystkie instrukcje. VEVOR zastrzega sobie jasną interpretację naszej instrukcji obsługi. Wygląd produktu będzie zależał od produktu, który otrzymałeś. Prosimy o wybaczenie, że nie poinformujemy Cię ponownie, jeśli w naszym produkcie pojawią się jakiegokolwiek aktualizacje technologiczne lub oprogramowania.

## INSTRUKCJE BEZPIECZEŃSTWA

### OSTRZEŻENIE:

Przeczytaj ten materiał przed użyciem tego produktu. Nieprzestrzeganie tego może spowodować poważne obrażenia.

Środki ostrożności podczas montażu 1.

Montaż należy wykonywać wyłącznie zgodnie z niniejszą instrukcją. Nieprawidłowy montaż może stwarzać zagrożenia.

2. Podczas montażu należy nosić okulary ochronne z atestem ANSI oraz wytrzymałe rękawice robocze.

3. Utrzymuj miejsce zgromadzenia w czystości i zapewnij dobre oświetlenie.

4. Podczas montażu nie dopuszczaj osób postronnych na teren montażu.

5. Nie przychodź na miejsce zdarzenia, jeśli jesteś zmęczony lub znajdujesz się pod wpływem alkoholu, narkotyków lub leków.

6. Możliwości produktu odnoszą się wyłącznie do produktów prawidłowo i kompletnie zmontowanych.

7. Montaż należy wykonać na płaskiej, równej, twardej i gładkiej powierzchni, która będzie bezpieczna. wspieranie drzewek dla kotów w stylu pudełkowym.

8. Aby uzyskać dodatkowe informacje dotyczące części wymienionych poniżej, strony, zapoznaj się ze schematem montażu w tym podręczniku. Rozpakuj i oddziel wszystkie części w czystym miejscu pracy.

Zachowaj środki

ostrożności 1. NIE SIADAJ ANI NIE STÓJ NA TYM PRZEDMIOCIE.

2. Ten produkt nie jest zabawką. Nie pozwalaj dzieciom bawić się nim ani przebywać w jego pobliżu. przedmiot.

3. Nie przekraczać określonego limitu obciążenia.





4. Używać wyłącznie na płaskiej, równej, twardej i gładkiej powierzchni, która może być bezpiecznie używana. obsługuje w pełni załadowane drzewka dla kotów w stylu pudełkowym.

5. Używać wyłącznie zgodnie z przeznaczeniem.



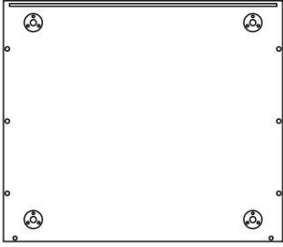
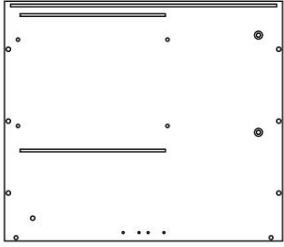
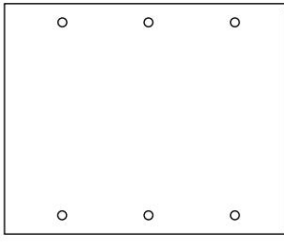
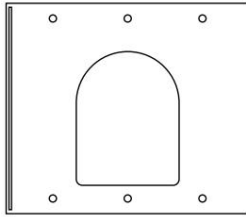
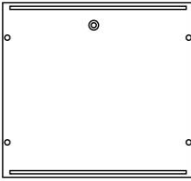
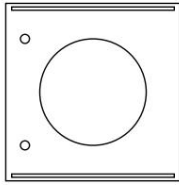
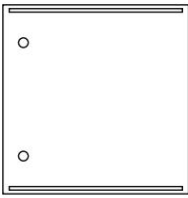
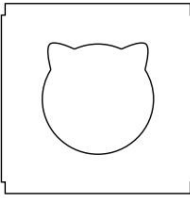
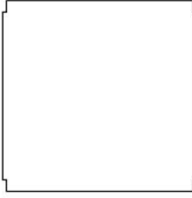

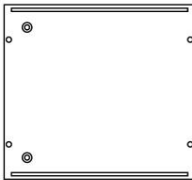
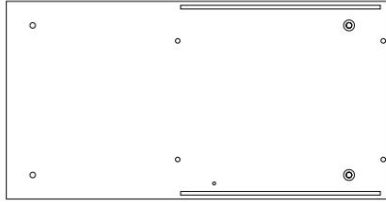
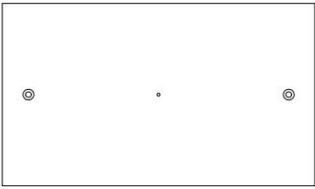
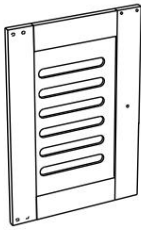
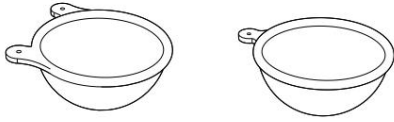









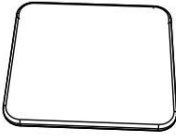





6. Przed każdym użyciem należy przeprowadzić kontrolę. Nie należy używać produktu, jeśli jakieś części są luźne lub uszkodzone.

ZAPISZ TĘ INSTRUKCJĘ

## Tabela akcesoriów

 <p>A×1</p>	 <p>B×1</p>	 <p>C×1</p>
 <p>D×1</p>	 <p>E×1</p>	 <p>P 2</p>
 <p>G×2</p>	 <p>Wysokość 2</p> <p>Ja × 2</p>	 <p>Ja × 2</p>
 <p>Z1</p>	 <p>K×1</p>	 <p>Długość × 1</p>
 <p>M×1</p>	 <p>N×2</p>	 <p>O1×1      O2×1</p>
 <p>*Każdy zestaw zawiera śrubokręt i klucz</p>		

## Tabela akcesoriów

<p>(Kolumny sizalowe) 30cm</p>  <p>1 × 1</p>	<p>(Owiń kolumnę) 30cm</p>  <p>2 × 6</p>	<p>37cm</p>  <p>3 × 2</p>
<p>(poduszka)</p>  <p>4 × 1</p>	<p>(poduszka)</p>  <p>5 × 2</p>	<p>(Zabawki wiosenne)</p>  <p>S × 2</p>
<p>(klamka) (Ogranicznik drzwi) (Zabawki w kształcie kulek futra) (Lina zabezpieczająca przed przewróceniem) (Obrotowy wał)</p>		
 <p>U × 2</p>  <p>W × 2</p>	 <p>X 1</p>  <p>Sz × 1</p>	 <p>Y × 4</p>
<p>(Regulowany podnóżek)</p>  <p>Z × 4</p> 	<p>(śruby 3 w 1)</p>  <p>Q1 × 20</p> 	<p>(M6*40)</p>  <p>Q2 × 8</p> <p>(M4*22)</p>  <p>Q3 × 2</p>
<p>(M4*12)</p>  <p>T1 × 12</p>	<p>(M8*30)</p>  <p>T2 × 10</p>	<p>(M8*70)</p>  <p>T3 × 4</p> <p>(M3*12)</p>  <p>T4 × 16</p>

# Kroki instalacji

## Krok 1

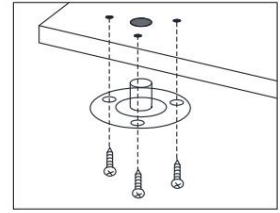
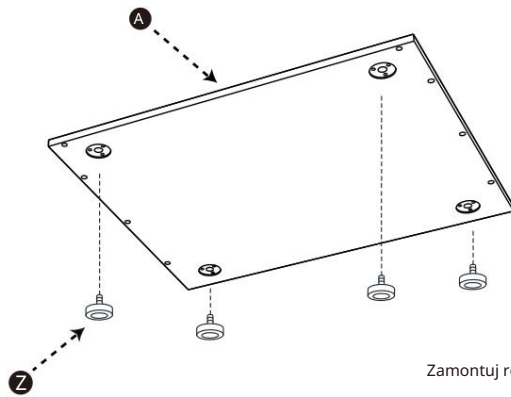

Zamontuj regulowaną podkładkę pod stopy na podstawie, jak pokazano na ilustracji;

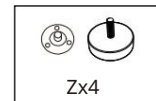
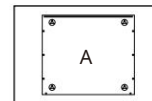

## Krok 2

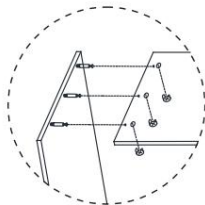

Na rysunku pokazano metodę montażu śrub trzy w jednym;

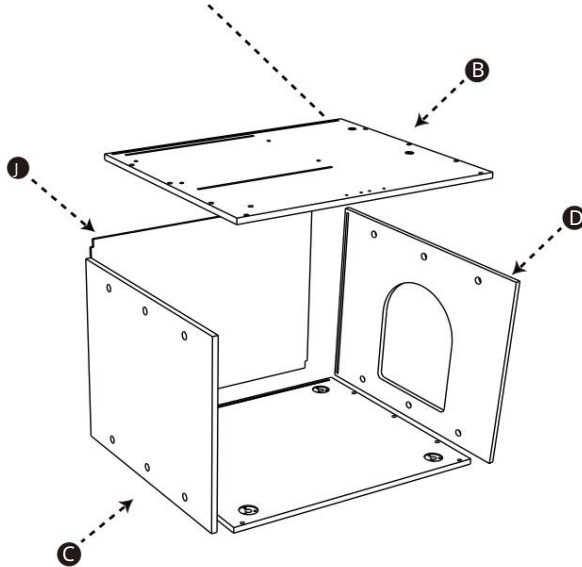

Najpierw złóż dolną szafkę, jak pokazano na rysunku;

(Uwaga: Przed dokręceniem należy wyrównać otwory)

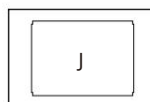
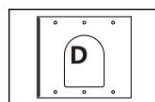
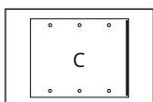
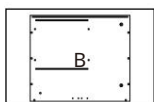

## Krok 3

Jak pokazano na rysunku, złóż odpowiedni ogranicznik drzwi i mały czarny nosek U;

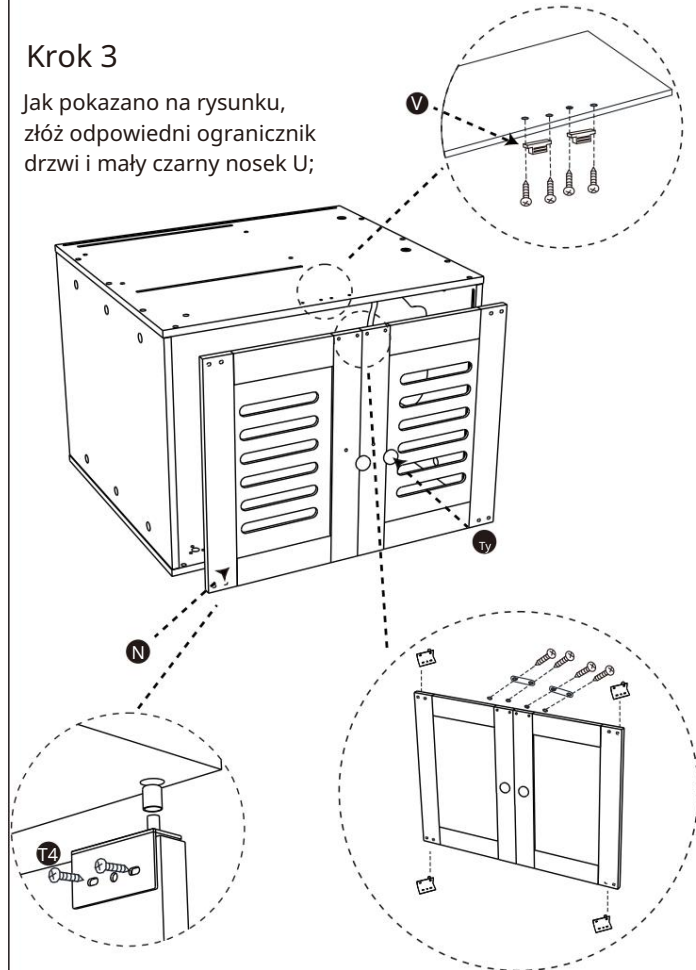

Najpierw załóż płytkę wrzecioną, a następnie zawias. Umieścić na drzwiach i dokręcić śruby;

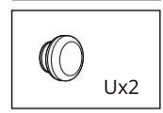
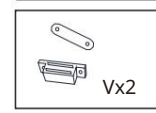
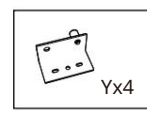
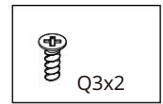
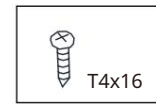

## Krok 4

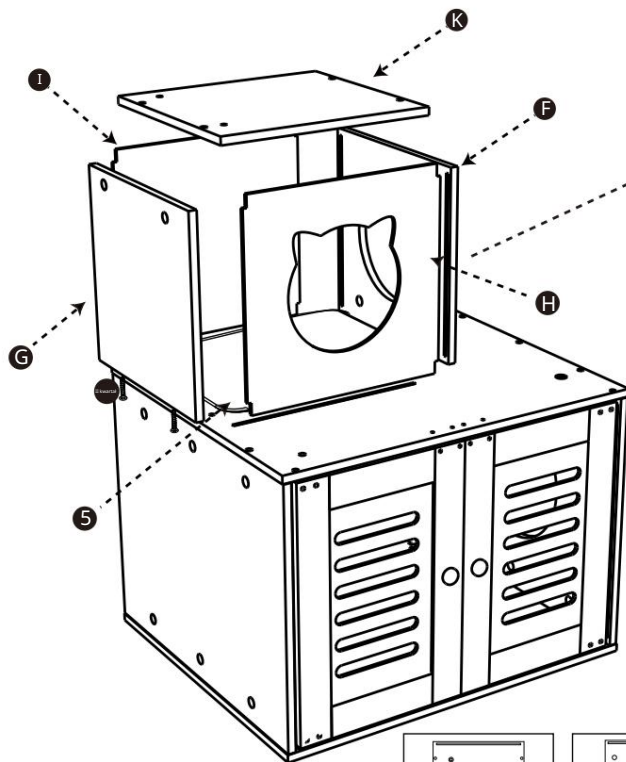

Włóż płytę I i płytę H do górnego rowka szafki;

Złóż legowisko dla kota nad szafką, jak pokazano na rysunku, a następnie połóż matę nr 5;

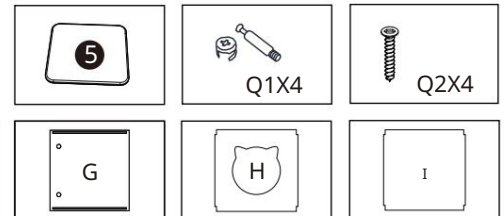

## Krok 5

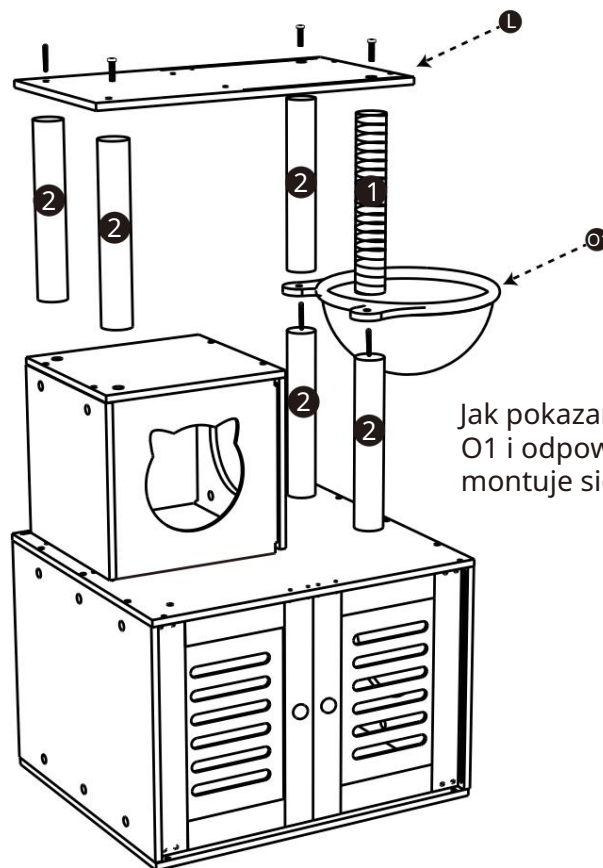

Jak pokazano na rysunku, montuje się hamak O1 i odpowiadającą mu kolumnę, a na końcu montuje się deskę drewnianą L;

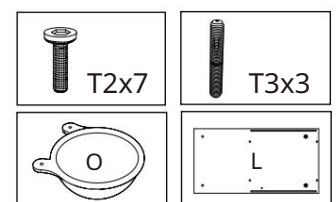

## Krok 6

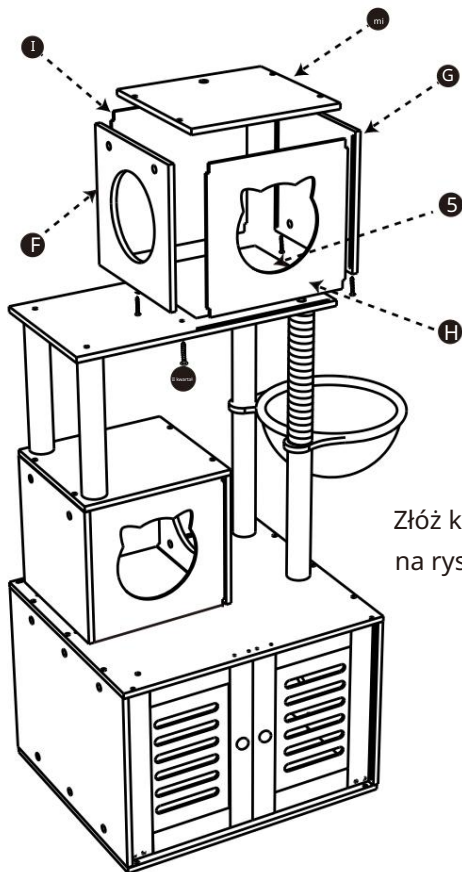

Złóż kolejne legowisko dla kota na szafce, jak pokazano na rysunku, a następnie włóż do niego matę nr 5;

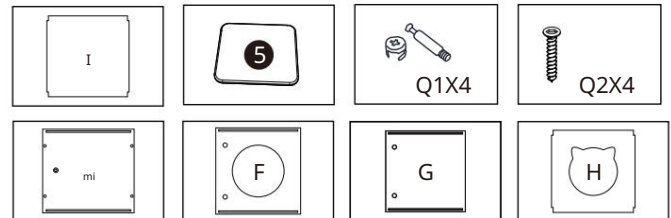

## Krok 7

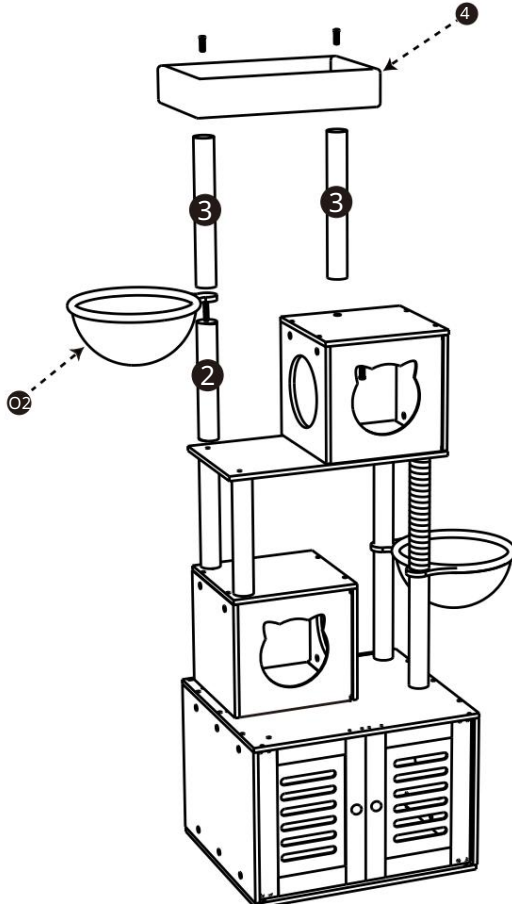

Jak pokazano na rysunku, montuje się hamak O2 i odpowiadającą mu kolumnę, a na końcu montuje się matę 4;

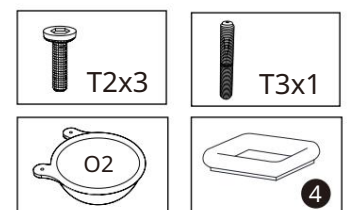



## PARAMETR PRODUKTU

Model	SSXG003
Kolor	Szary
Rozmiar produktu	600*520*1850 mm

Producent: Shanghaimuxinmuyeyouxiangongsi Adres:  
Shuangchenglu 803nong11hao1602A-1609shi, baoshanqu, szanghaj  
200000 CN.

Importowane do AUS: SIHAO PTY LTD. 1 ROKEVA STREETEASTWOOD NSW 2122 Australia

Importowane do USA: Sanven Technology Ltd. Suite 250, 9166 Anaheim  
Place, Rancho Cucamonga, CA 91730

Przedstawiciel UE
-------------------

E-CrossStu GmbH  
Mainzer Landstr.69, 60329 Frankfurt nad Menem.

REP WIELKIEJ BRYTANII
-----------------------

YH CONSULTING LIMITED.  
C/O YH Consulting Limited Biuro 147, Centurion  
Dom, London Road, Staines-upon-Thames, Surrey,  
TW18 4AX

**VEVOR<sup>®</sup>**  
**TOUGH TOOLS, HALF PRICE**

Wsparcie techniczne i certyfikat gwarancji  
elektronicznej [www.vevor.com/support](http://www.vevor.com/support)



# **VEVOR<sup>®</sup>**

## **TOUGH TOOLS, HALF PRICE**

Technischer Support und E-Garantie-Zertifikat [www.vevor.com/support](http://www.vevor.com/support)

### **KATZENBÄUME IM BOX-STIL**

### **BENUTZERHANDBUCH**

Wir sind weiterhin bestrebt, Ihnen Werkzeuge zu wettbewerbsfähigen Preisen anzubieten.

„Sparen Sie die Hälfte“, „Halber Preis“ oder andere ähnliche Ausdrücke, die wir verwenden, stellen nur eine Schätzung der Ersparnis dar, die Sie beim Kauf bestimmter Werkzeuge bei uns im Vergleich zu den großen Topmarken erzielen können, und decken nicht unbedingt alle von uns angebotenen Werkzeugkategorien ab. Wir möchten Sie freundlich daran erinnern, bei Ihrer Bestellung bei uns sorgfältig zu prüfen, ob Sie im Vergleich zu den großen Topmarken tatsächlich die Hälfte sparen.



**VEVOR**<sup>®</sup>  
TOUGH TOOLS, HALF PRICE

KATZENBÄUME IM BOX-STIL

MODELL:SSXG003

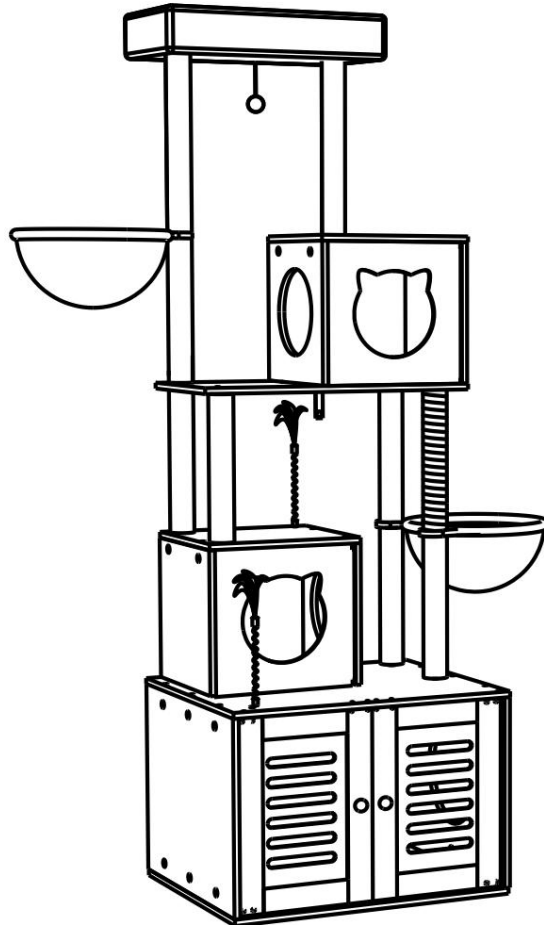

**Brauchen Sie Hilfe? Kontaktieren Sie uns!**

Haben Sie Fragen zum Produkt? Benötigen Sie technischen Support? Bitte kontaktieren Sie uns:  
Technischer Support und E-Garantie-Zertifikat [www.vevor.com/support](http://www.vevor.com/support)

Dies ist die Originalanleitung. Bitte lesen Sie alle Anweisungen sorgfältig durch, bevor Sie das Gerät in Betrieb nehmen. VEVOR behält sich eine klare Auslegung unserer Bedienungsanleitung vor. Das Erscheinungsbild des Produkts richtet sich nach dem Produkt, das Sie erhalten haben. Bitte verzeihen Sie uns, dass wir Sie nicht erneut informieren, wenn es Technologie- oder Software-Updates für unser Produkt gibt.

## SICHERHEITSHINWEISE

### **WARNUNG:**

**Lesen Sie dieses Material, bevor Sie dieses Produkt verwenden. Andernfalls kann es zu schweren Verletzungen kommen.**

### **Vorsichtsmaßnahmen bei der**

**Montage** 1. Die Montage muss gemäß dieser Anleitung erfolgen. Eine unsachgemäße Montage kann Gefahren schaffen.

2. Tragen Sie während der Montage eine ANSI-geprüfte Schutzbrille und strapazierfähige Arbeitshandschuhe.

3. Halten Sie den Versammlungsbereich sauber und gut beleuchtet.

4. Halten Sie während der Montage unbeteiligte Zuschauer vom Bereich fern.

5. Nicht zusammenbauen, wenn Sie müde sind oder unter dem Einfluss von Alkohol, Drogen oder Medikamenten stehen.

6. Die Produkteigenschaften gelten nur für ordnungsgemäß und vollständig montierte Produkte.

7. Auf einer flachen, ebenen, harten und glatten Oberfläche montieren, die sicher Unterstützung der Katzenbäume im Box-Stil.

8. Weitere Informationen zu den im Folgenden aufgeführten Teilen finden Sie  
Seiten finden Sie im Montagediagramm dieses Handbuchs. Packen Sie alle Teile in einem sauberen Arbeitsbereich aus und trennen Sie sie.

### **Vorsichtsmaßnahmen**

**treffen** 1. NICHT AUF DIESEM GEGENSTAND SITZEN ODER STEHEN.

2. Dieses Produkt ist kein Spielzeug. Erlauben Sie Kindern nicht, mit oder in der Nähe dieses Artikel.

3. Überschreiten Sie nicht die angegebene Gewichtskapazität.





4. Nur auf einer flachen, ebenen, harten und glatten Oberfläche verwenden, die sicher unterstützt einen voll beladenen Katzenbaum im Boxstil.

5. Nur bestimmungsgemäß verwenden.



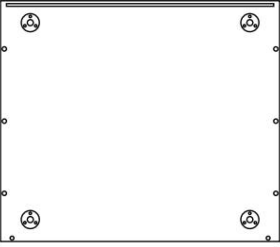
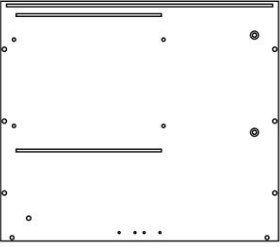
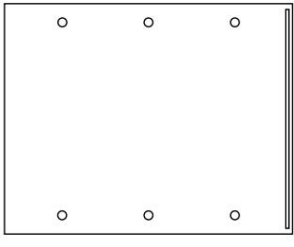
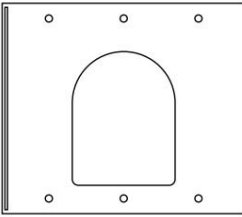
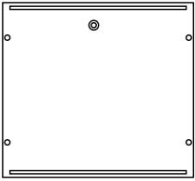
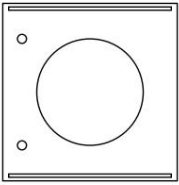
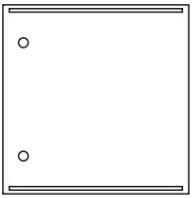
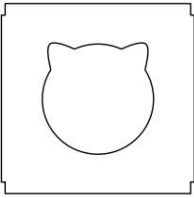
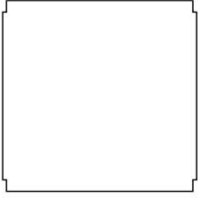

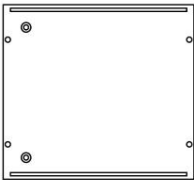
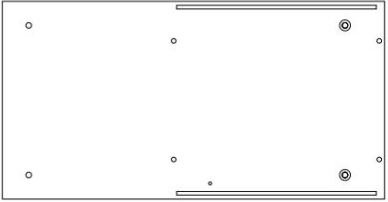
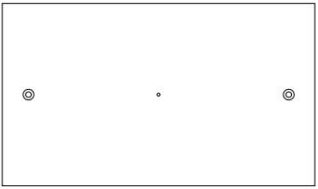
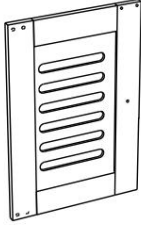
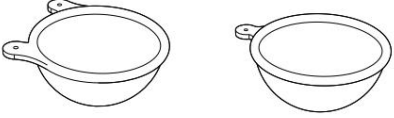









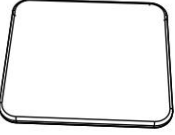

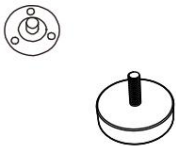

6. Vor jedem Gebrauch prüfen; nicht verwenden, wenn Teile lose oder beschädigt sind.

**BEWAHREN SIE DIESES HANDBUCH AUF**

# Zubehörtabelle

		
A x 1	B x 1	C x 1
		
D x 1	E x 1	F x 2
		
G x 2	H x 2	I x 2
		
J x 1	K x 1	L x 1
		
M x 1	N x 2	O1 x 1      O2 x 1
	* Jedes Set enthält einen Schraubendreher und einen Schraubenschlüssel	

# Zubehörtabelle

<p>(Sisalsäulen) 30cm</p>  <p>1 x1</p>	<p>(Spalte umbrechen) 30 cm</p>  <p>2 x6</p>	<p>37 cm</p>  <p>3 x2</p>
<p>(Kissen)</p>  <p>4 x1</p>	<p>(Kissen)</p>  <p>5 x2</p>	<p>(Federspielzeug)</p>  <p>Sx2</p>
<p>(Türklinke) (Türstopper) (Fellball-Spielzeug) (Kippschutzseil) (Rotierende Welle)</p>		
 <p>Ux2</p>  <p>Vx2</p>	 <p>Xx1</p>  <p>Bx1</p>	 <p>Yx4</p>
<p>(Verstellbare Fußstütze)</p>  <p>Zx4</p>	<p>(3-in-1-Schrauben)</p>  <p>Frage 1x20</p>	<p>(M6*40)</p>  <p>Frage 2x8</p> <p>(M4*22)</p>  <p>Frage 3x2</p>
<p>(M4*12)</p>  <p>T1 x12</p>	<p>(M8*30)</p>  <p>T2 x10</p>	<p>(M8*70)</p>  <p>T3 x4</p> <p>(M3*12)</p>  <p>T4 x16</p>

# Installationsschritte

## Schritt 1

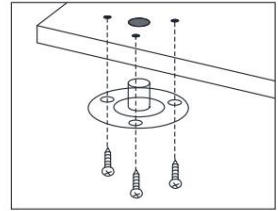
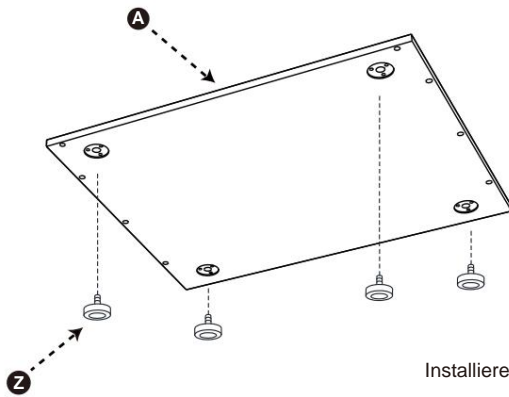

Installieren Sie das verstellbare Fußpolster wie abgebildet auf der Basis.

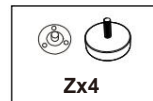
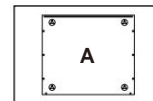

## Schritt 2

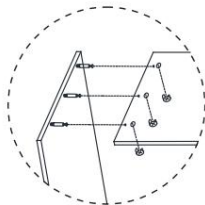

Die Drei-in-Eins-Schraubeneinstallationsmethode ist in der Abbildung dargestellt.

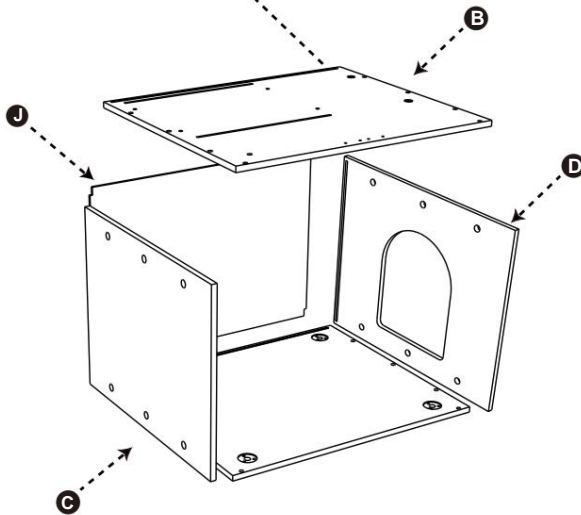

Montieren Sie zuerst den Unterschrank, wie in der Abbildung gezeigt;

Hinweis: Richten Sie die Löcher vor dem Festziehen aus.

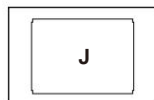
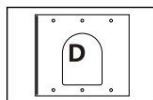
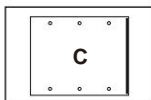
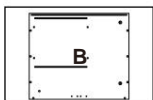

## Schritt 3

Montieren Sie, wie in der Abbildung gezeigt, den dazugehörigen Türstopper und die kleine schwarze Nase U;

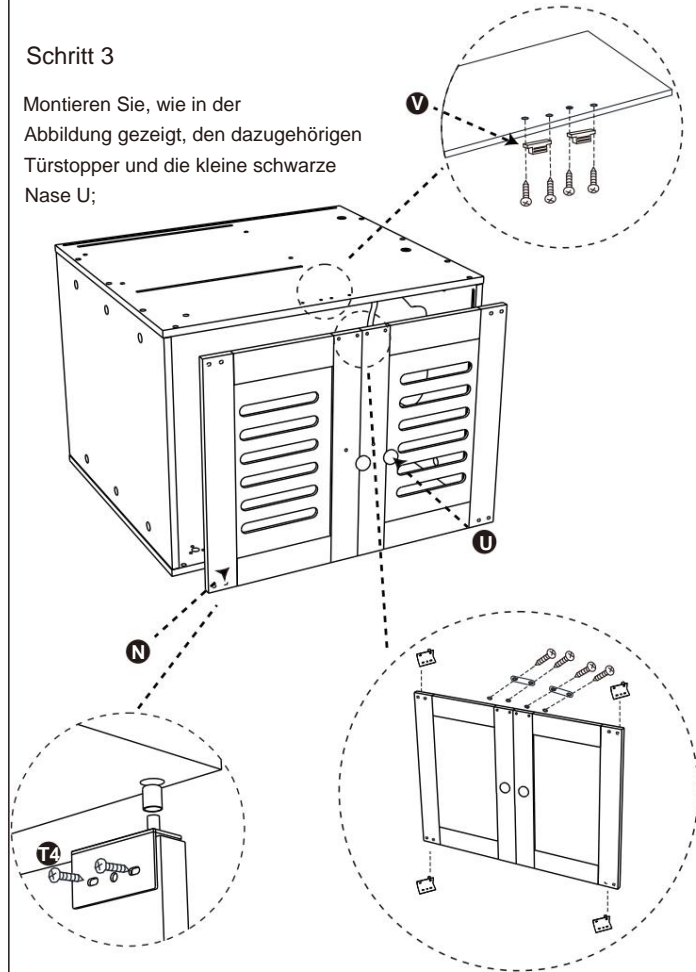

Setzen Sie zuerst die Spindelplatte und dann das Scharnier ein. Auf die Tür setzen und die Schrauben festziehen;

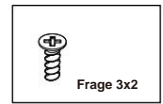
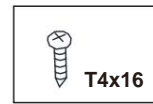
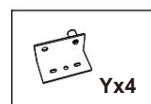

Schritt 4

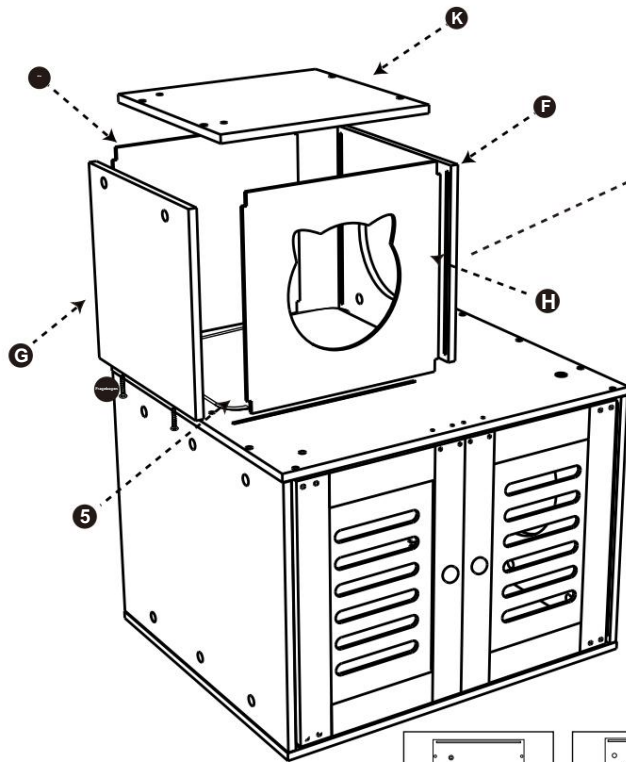

Setzen Sie die I-Platte und die H-Platte in die obere Nut des Schrankes ein.

Bauen Sie das Katzennest über dem Schrank wie in der Abbildung gezeigt zusammen und legen Sie zum Schluss die Matte 5 auf;

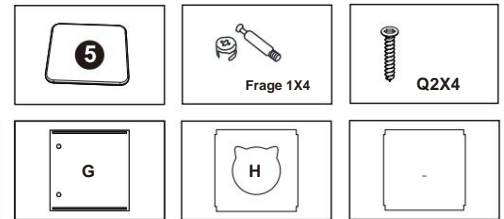

Schritt 5

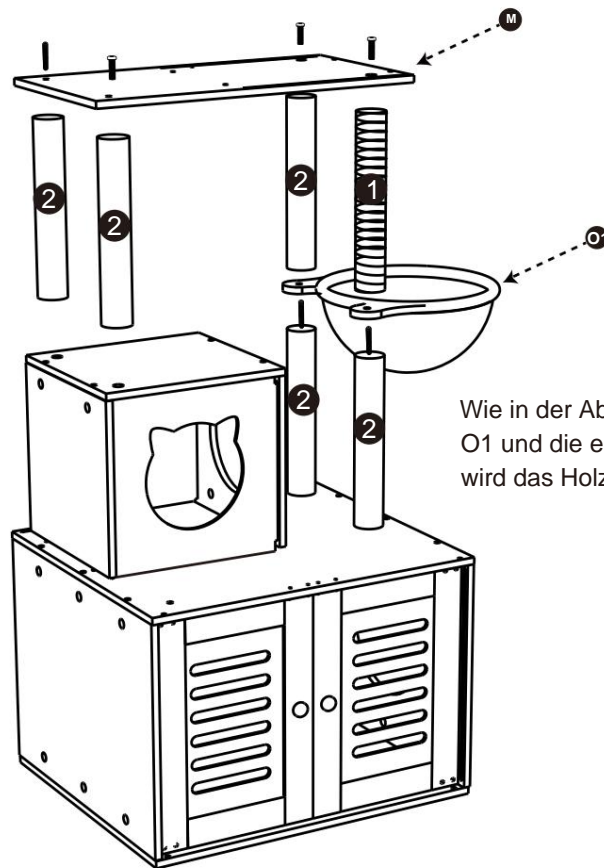

Wie in der Abbildung gezeigt, werden die Hängematte O1 und die entsprechende Säule installiert und schließlich wird das Holzbrett L installiert.

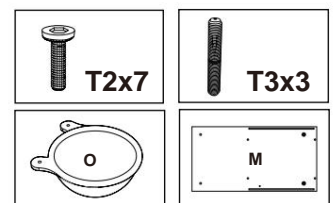

Schritt 6

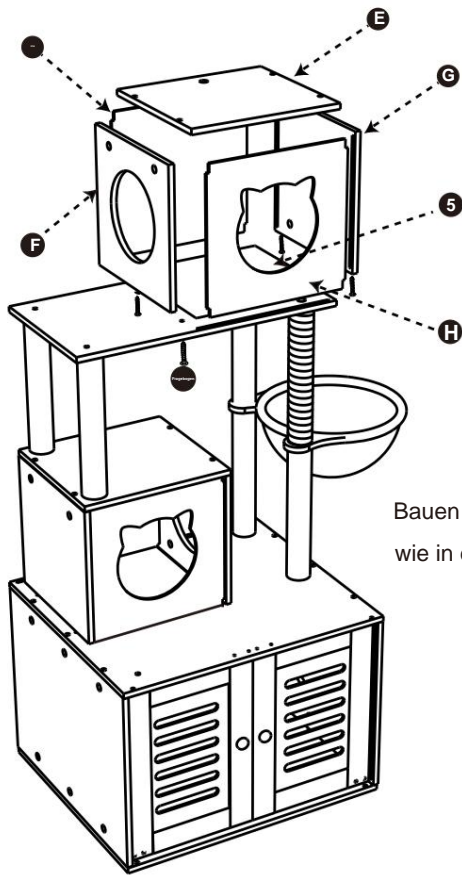

Bauen Sie ein weiteres Katzenest auf dem Schrank zusammen, wie in der Abbildung gezeigt, und legen Sie zum Schluss die Matte 5 hinein;

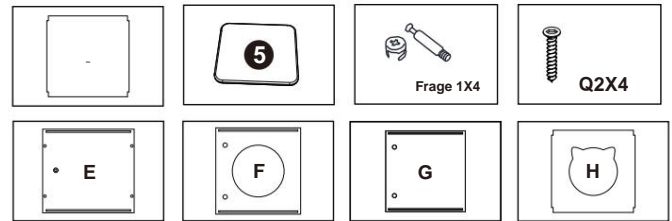

Schritt 7

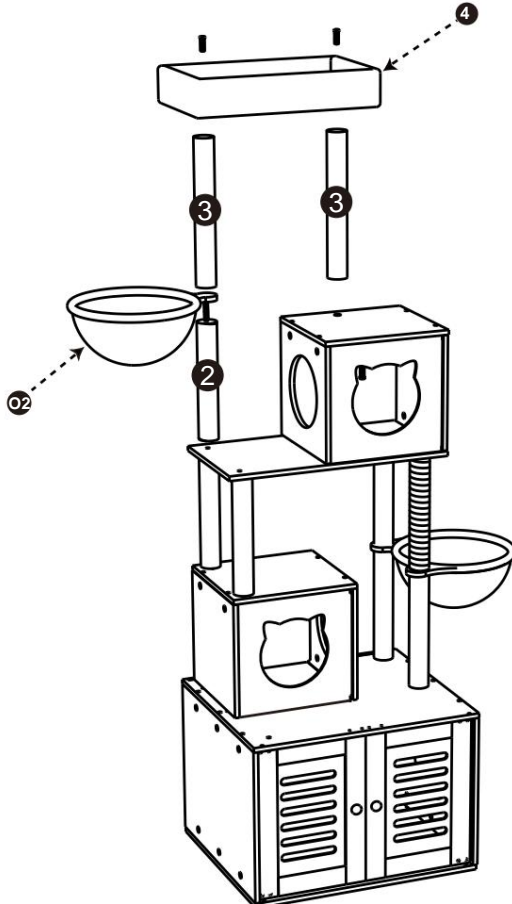

Wie in der Abbildung gezeigt, werden die Hängematte O2 und die entsprechende Säule installiert und schließlich wird die Matte 4 installiert;

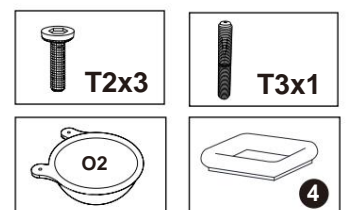

## Schritt 8

Stecken Sie das Expansionsrohr in die Wand und befestigen Sie anschließend das Kippschutzseil mit selbstschneidendem Draht an der Wand; befestigen Sie abschließend die andere Seite mit Schrauben am Katzenklettergerüst.

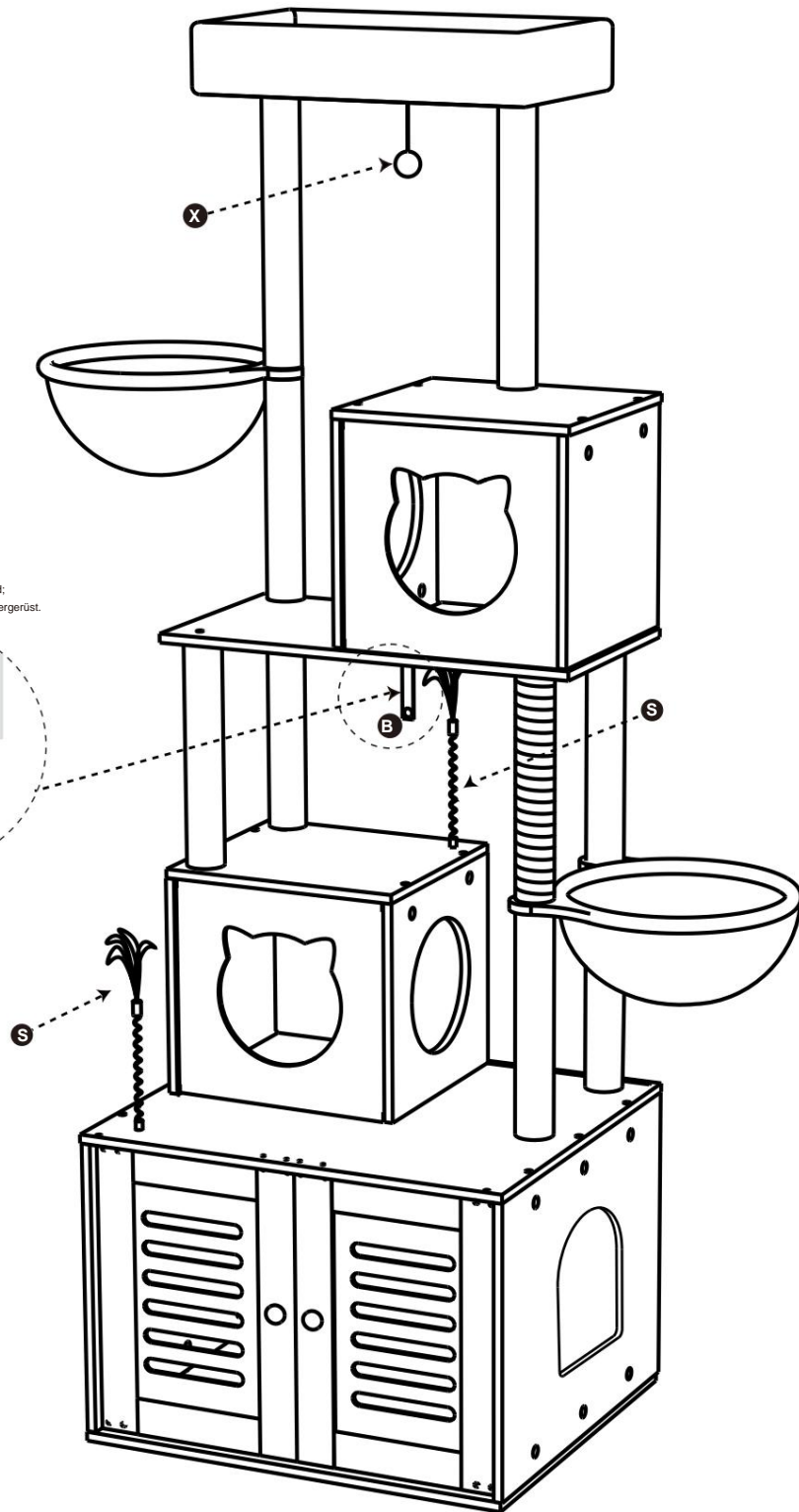
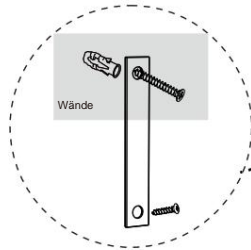

Montieren Sie das Haarballenspielzeug und das Federspielzeug wie in der Abbildung gezeigt und ziehen Sie es abschließend fest, sodass die Schrauben fixiert werden können.

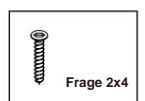
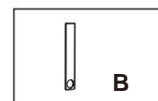
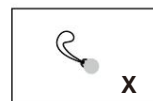

## PRODUKTPARAMETER

<b>Modell</b>	SSXG003
<b>Farbe</b>	Grau
<b>Produktgröße</b>	600*520*1850 mm

**Hersteller:** Shanghaimuxinmuyeyouxiangongsi **Adresse:**

Shuangchenglu 803nong11hao1602A-1609shi, baoshanqu, Shanghai 200000 CN.

**Nach AUS importiert:** SIHAO PTY LTD. 1 ROKEVA STREETEASTWOOD NSW 2122  
Australien

**Importiert in die USA:** Sanven Technology Ltd. Suite 250, 9166 Anaheim Place,  
Rancho Cucamonga, CA 91730

<b>Vertreter der EG</b>
-------------------------

E-CrossStu GmbH  
Mainzer Landstr.69, 60329 Frankfurt am Main.

<b>UK REP</b>
---------------

YH CONSULTING LIMITED.  
C/O YH Consulting Limited Office 147, Centurion  
Haus, London Road, Staines-upon-Thames, Surrey,  
TW18 4AX

**VEVOR<sup>®</sup>**  
**TOUGH TOOLS, HALF PRICE**

**Technischer Support und E-Garantie-Zertifikat**  
**[www.vevor.com/support](http://www.vevor.com/support)**



# VEVOR®

## TOUGH TOOLS, HALF PRICE

Assistance technique et certificat de garantie électronique [www.vevor.com/support](http://www.vevor.com/support)

### ARBRES À CHAT DE TYPE BOÎTE

### MANUEL D'UTILISATION

Nous continuons à nous engager à vous fournir des outils à des prix compétitifs.

« Économisez la moitié », « Moitié prix » ou toute autre expression similaire utilisée par nous ne représente qu'une estimation des économies que vous pourriez réaliser en achetant certains outils chez nous par rapport aux grandes marques et ne couvre pas nécessairement toutes les catégories d'outils que nous proposons. Nous vous rappelons de bien vouloir vérifier soigneusement lorsque vous passez une commande chez nous si vous économisez réellement la moitié par rapport aux grandes marques.



**VEVOR**<sup>®</sup>  
TOUGH TOOLS, HALF PRICE

ARBRES À CHAT DE TYPE BOÎTE

MODÈLE : SSXG003

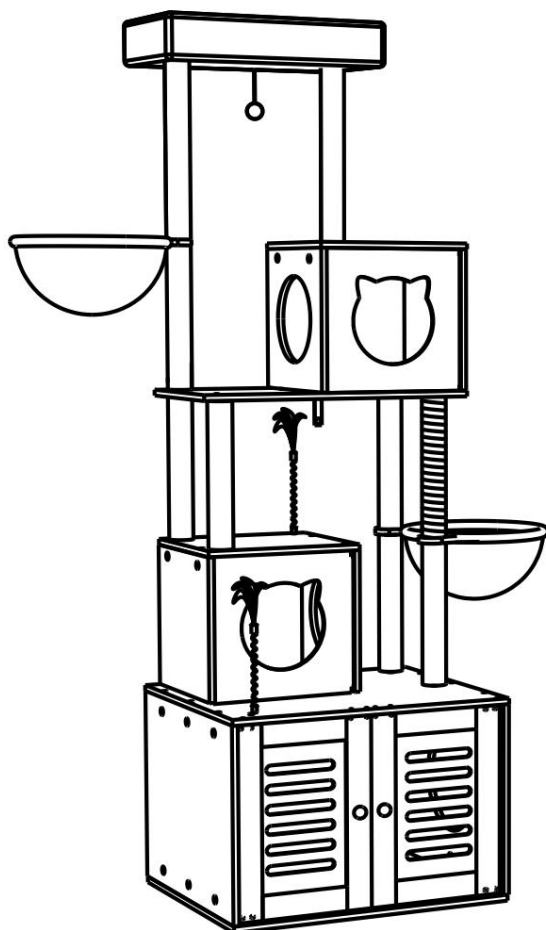

### BESOIN D'AIDE? CONTACTEZ-NOUS!

Vous avez des questions sur nos produits ? Vous avez besoin d'assistance technique ? N'hésitez pas à nous contacter : Assistance technique et certificat de garantie électronique [www.vevor.com/support](http://www.vevor.com/support)

Il s'agit de la notice d'utilisation d'origine. Veuillez lire attentivement toutes les instructions du manuel avant de l'utiliser. VEVOR se réserve le droit d'interpréter clairement notre manuel d'utilisation. L'apparence du produit dépend du produit que vous avez reçu. Veuillez nous excuser, nous ne vous informerons plus en cas de mise à jour technologique ou logicielle de notre produit.

## CONSIGNES DE SÉCURITÉ

### AVERTISSEMENT:

Lisez ce document avant d'utiliser ce produit. Le non-respect de ces instructions peut entraîner des blessures graves.

### Précautions d'assemblage 1.

Assemblez uniquement selon ces instructions. Un assemblage incorrect peut créer des dangers.

2. Portez des lunettes de sécurité approuvées ANSI et des gants de travail robustes pendant l'assemblage.

3. Gardez la zone de montage propre et bien éclairée.

4. Gardez les spectateurs hors de la zone pendant le montage.

5. Ne montez pas si vous êtes fatigué ou sous l'influence de l'alcool, de drogues ou de médicaments.

6. Les capacités du produit s'appliquent uniquement aux produits correctement et complètement assemblés.

7. Assemblez sur une surface plane, de niveau, dure et lisse capable de supporter en toute sécurité soutenir les arbres à chat de style boîte.

8. Pour plus d'informations sur les pièces répertoriées ci-dessous pages, veuillez vous référer au schéma d'assemblage de ce manuel. Déballez et séparez toutes les pièces dans un espace de travail propre.

### Précautions d'utilisation 1.

**NE PAS S'ASSEOIR OU SE TENIR DEBOUT SUR CET ARTICLE.**

2. Ce produit n'est pas un jouet. Ne laissez pas les enfants jouer avec ou à proximité de ce produit article.

3. Ne pas dépasser les capacités de poids spécifiées.

4. Utiliser uniquement sur une surface plane, nivelée, dure et lisse qui peut être utilisée en toute sécurité. prend en charge un arbre à chat de style boîte entièrement chargé.

5. Utiliser uniquement comme prévu.

6. Inspectez avant chaque utilisation ; ne pas utiliser si des pièces sont desserrées ou endommagées.

CONSERVER CE MANUEL

# Tableau des accessoires











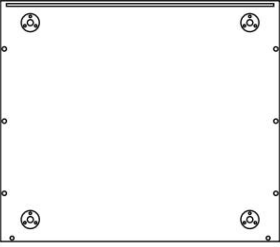
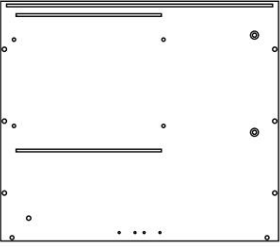
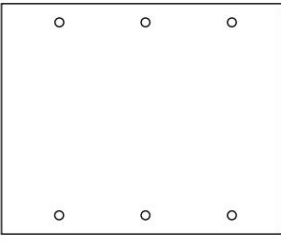
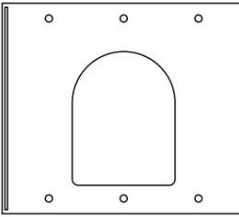
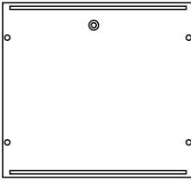
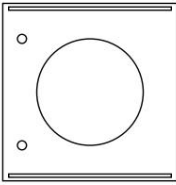
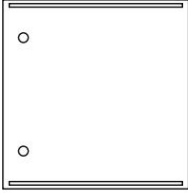
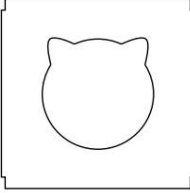
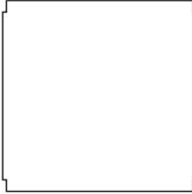
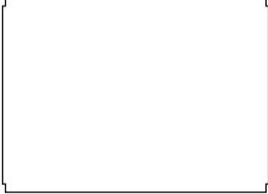
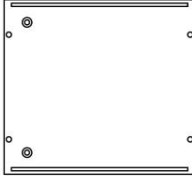
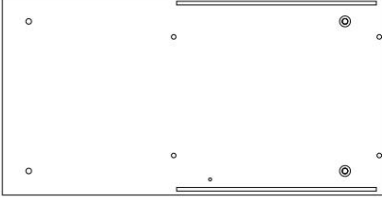
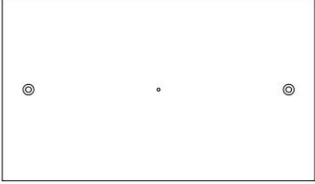
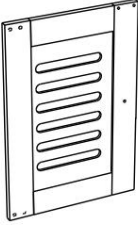
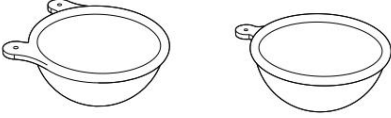

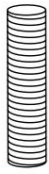



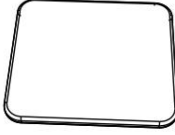

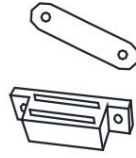

		
Un x 1	B x 1	C x 1
		
D x 1	E x 1	F x 2
		
G x 2	H x 2	Je x 2
		
J x 1	K x 1	L x 1
		
M x 1	N x 2	O1 x 1      O2 x 1
	*Chaque ensemble est livré avec un tournevis et une clé	

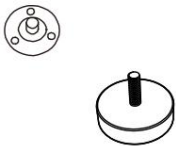
Tableau des accessoires

<p>(Colonnes en sisal) 30cm</p>  <p>1 x1</p>	<p>(Envelopper la colonne) 30 cm</p>  <p>2 x6</p>	<p>37 cm</p>  <p>3 x2</p>
<p>(coussin)</p>  <p>4 x1</p>	<p>(coussin)</p>  <p>5 x2</p>	<p>(Jouets à ressort)</p>  <p>Sx2</p>
<p>(poignée de porte)</p>  <p>Ux2</p>	<p>(Butée de porte)</p>  <p>Vx2</p>	<p>(Jouets boules de poils) (Corde anti-basculement) (Arbre rotatif)</p>  <p>Xx1</p>  <p>Lx1</p>  <p>Yx4</p>
<p>(Repose-pieds réglable)</p>  <p>Zx4</p>	<p>(vis 3 en 1)</p>   <p>Q1x20</p>	<p>(M6*40)</p>  <p>Q2x8</p> <p>(M4*22)</p>  <p>Q3x2</p>
<p>(M4*12)</p>  <p>T1 x 12</p>	<p>(M8*30)</p>  <p>T2 x10</p>	<p>(M8*70)</p>  <p>T3 x4</p> <p>(M3*12)</p>  <p>T4 x16</p>

# Étapes d'installation

## Étape 1

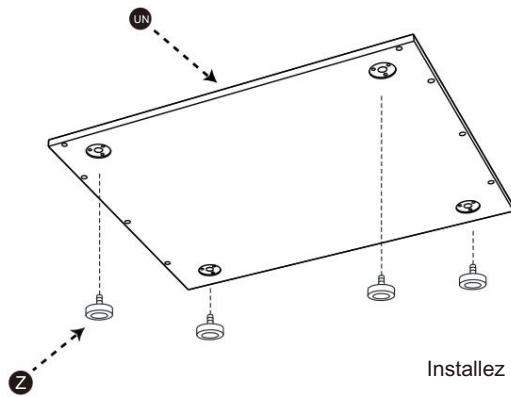

Installez le repose-pied réglable sur la base comme illustré ;

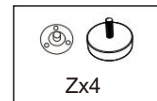
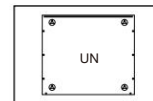

## Étape 2

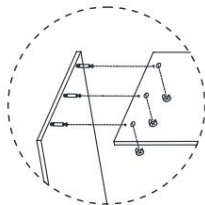

La méthode d'installation de vis trois en un est illustrée sur la figure ;

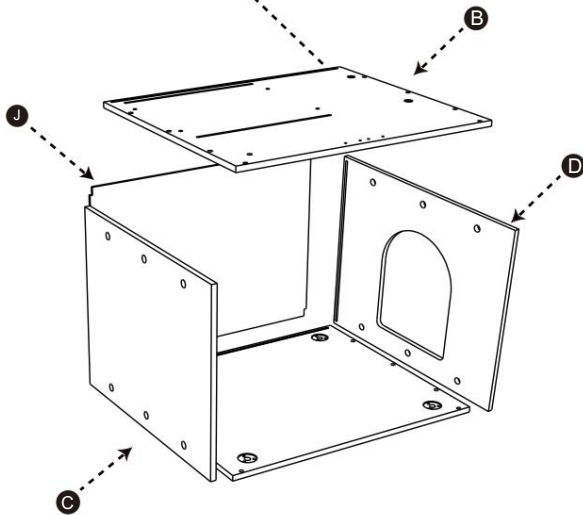

Assemblez d'abord l'armoire inférieure comme indiqué sur la figure ;

(Remarque : alignez les trous avant de serrer)

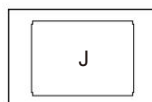
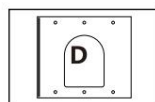
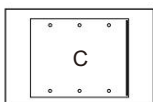
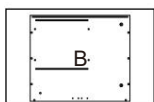

## Étape 3

Comme indiqué sur la figure, assemblez la butée de porte correspondante et le petit nez noir U ;

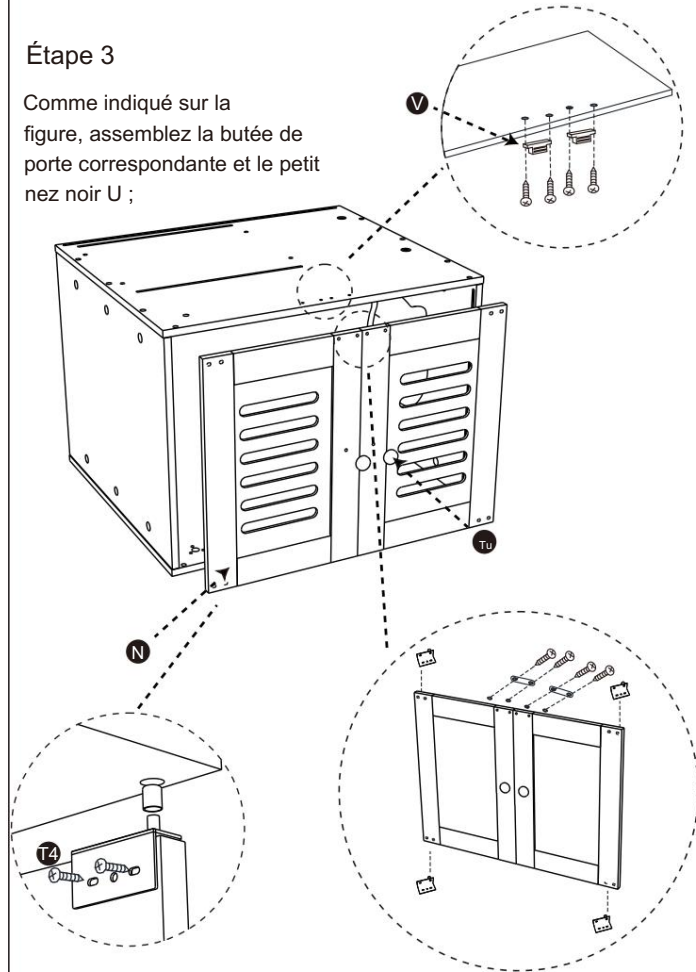

Placez d'abord la plaque de broche, puis placez la charnière. Placer sur la porte et serrer les vis ;

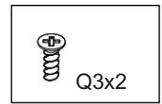
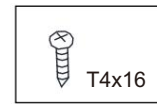
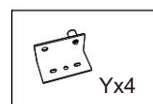

## Étape 4

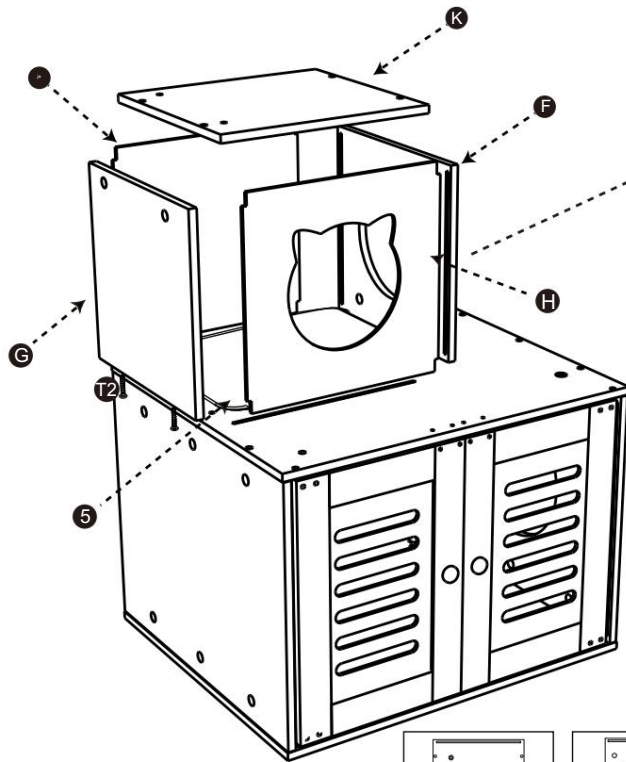

Insérez la plaque I et la plaque H dans la rainure supérieure de l'armoire ;

Assemblez le nid pour chat au-dessus de l'armoire comme indiqué sur la figure, et enfin placez le tapis 5 dessus ;

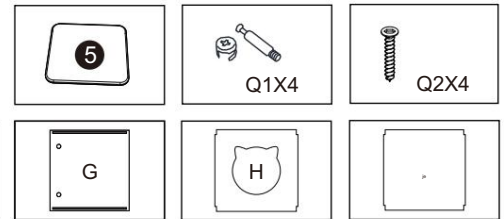

## Étape 5

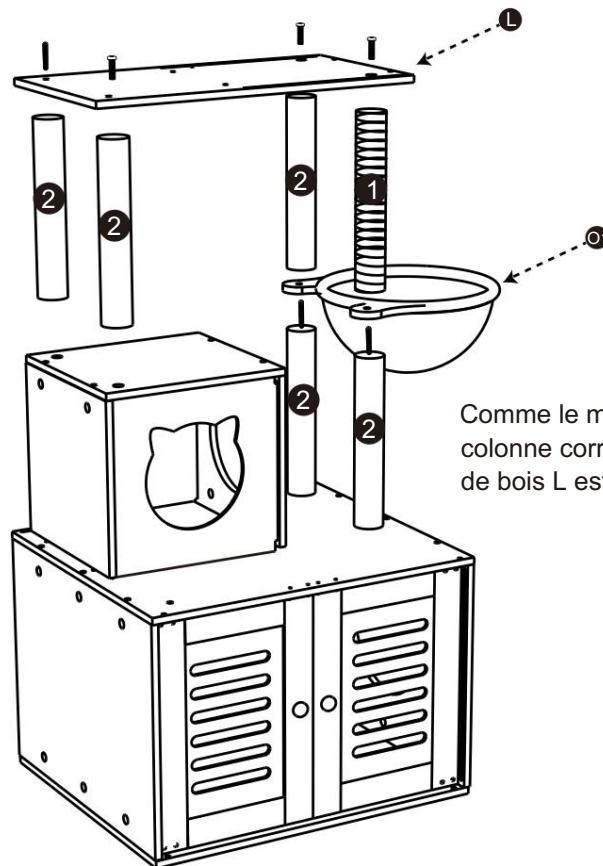

Comme le montre la figure, le hamac O1 et la colonne correspondante sont installés, et enfin la planche de bois L est installée ;

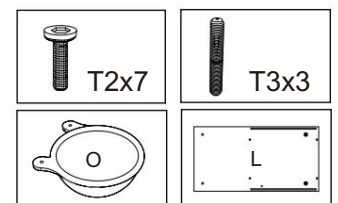

Étape 6

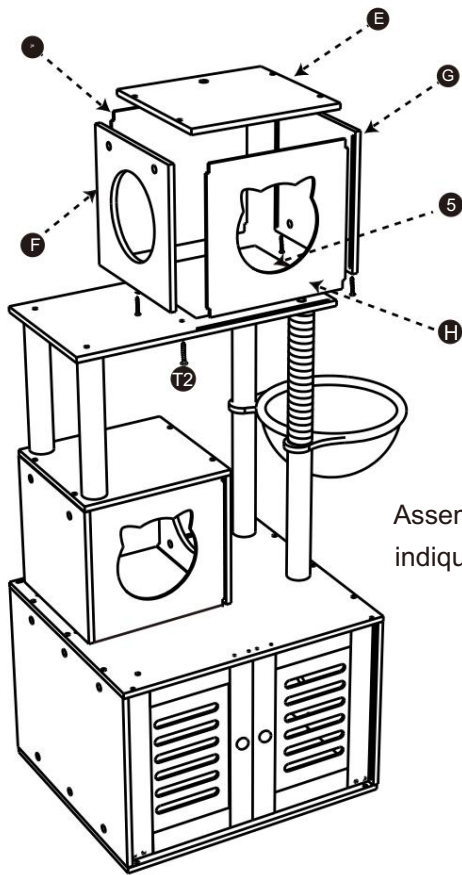

Assemblez un autre nid pour chat sur l'armoire comme indiqué sur la figure, et enfin placez-y le tapis 5 ;

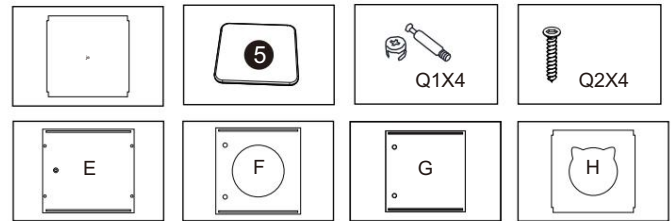

Étape 7

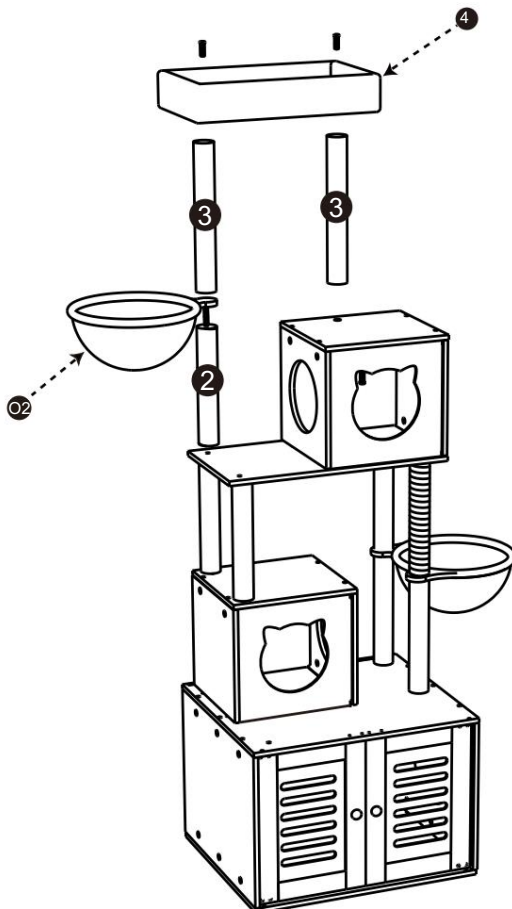

Comme le montre la figure, le hamac O2 et la colonne correspondante sont installés, et enfin le tapis 4 est installé ;

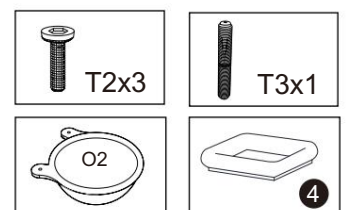

## Étape 8

Branchez le tuyau d'expansion dans le mur, puis fixez la corde anti-basculement sur le mur avec du fil autotaraudeur ; Enfin, utilisez des vis pour fixer l'autre côté au cadre d'escalade pour chat.

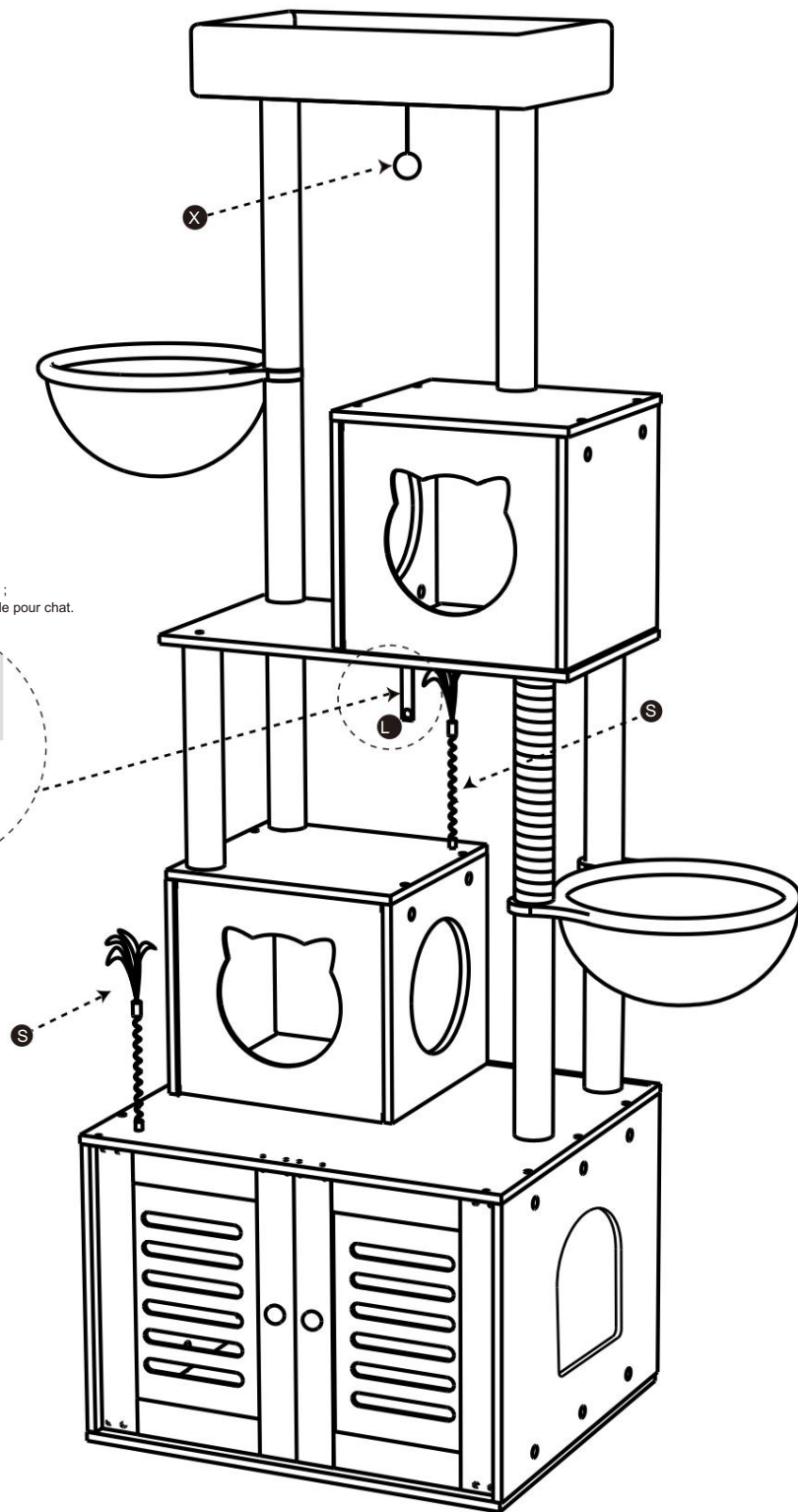
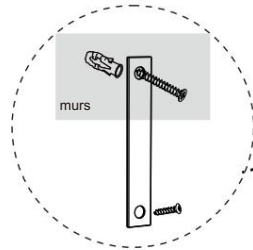

Installez le jouet boule de poils et le jouet à ressort comme indiqué sur l'image, puis serrez-le enfin pour que les vis puissent être fixées.

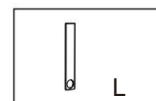
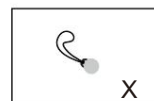
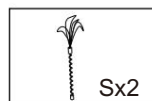

## PARAMÈTRE DU PRODUIT

Modèle	SSXG003
Couleur	Gris
Taille du produit	600*520*1850mm

Fabricant : Shanghai muxin muyeyouxiangongsi Adresse :  
Shuangchenglu 803nong11hao1602A-1609shi, baoshanqu, shanghai 200000 CN.

Importé en Australie : SIHAO PTY LTD. 1 ROKEVA STREET EASTWOOD NSW 2122  
Australie

Importé aux États-Unis : Sanven Technology Ltd. Suite 250, 9166 Anaheim Place,  
Rancho Cucamonga, CA 91730

REPRÉSENTANT	DE LA CE
--------------	----------

E-CrossStu GmbH  
Mainzer Landstr.69, 60329 Francfort-sur-le-Main.

REPRÉSENTANT	DU ROYAUME-UNI
--------------	----------------

YH CONSULTING LIMITÉE.  
A/S YH Consulting Limited Bureau 147, Centurion  
Maison, London Road, Staines-upon-Thames, Surrey,  
TW18 4AX

**VEVOR<sup>®</sup>**  
**TOUGH TOOLS, HALF PRICE**

Assistance technique et certificat de garantie  
électronique [www.vevor.com/support](http://www.vevor.com/support)



# **VEVOR<sup>®</sup>**

## **TOUGH TOOLS, HALF PRICE**

Technische ondersteuning en e-garantiecertificaat [www.vevor.com/support](http://www.vevor.com/support)

### **KATTENBOMEN IN DOOSSTIJL**

### **GEBRUIKERSHANDLEIDING**

Wij streven er voortdurend naar om u gereedschappen tegen concurrerende prijzen te leveren.

"Save Half", "Half Price" of andere soortgelijke uitdrukkingen die wij gebruiken, geven alleen een schatting van de besparingen die u kunt behalen door bepaalde gereedschappen bij ons te kopen in vergelijking met de grote topmerken en betekent niet noodzakelijkerwijs dat alle categorieën gereedschappen die wij aanbieden, worden gedekt. Wij herinneren u eraan om zorgvuldig te controleren of u daadwerkelijk de helft bespaart in vergelijking met de grote topmerken wanneer u een bestelling bij ons plaatst.



# VEVOR<sup>®</sup>

TOUGH TOOLS, HALF PRICE

KATTENBOMEN IN DOOSSTIJL

MODEL:SSXG003

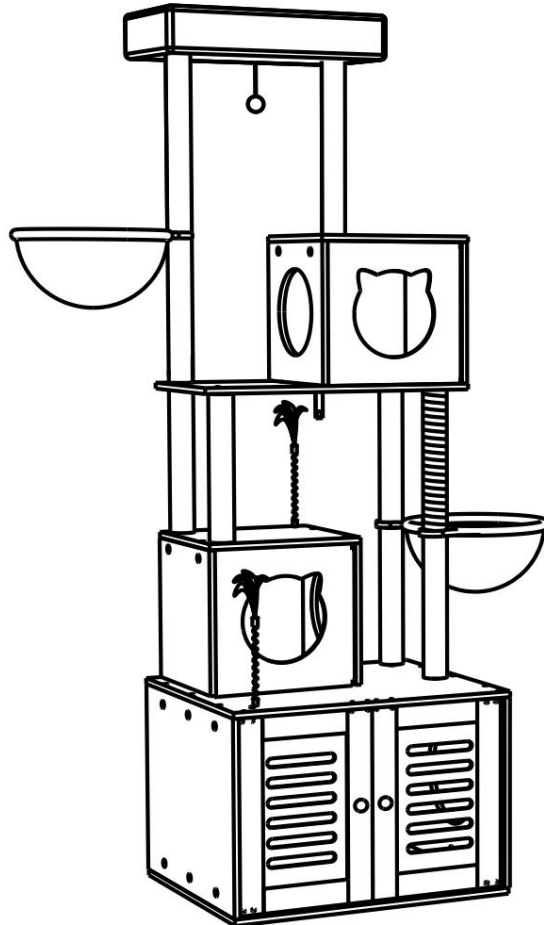

## HULP NODIG? NEEM CONTACT MET ONS OP!

Heeft u vragen over het product? Heeft u technische ondersteuning nodig? Neem dan gerust contact met ons op: Technische ondersteuning en E-garantiecertificaat [www.vevor.com/support](http://www.vevor.com/support)

Dit is de originele instructie, lees alle handleidingen zorgvuldig door voordat u het product gebruikt. VEVOR behoudt zich een duidelijke interpretatie van onze gebruikershandleiding voor. Het uiterlijk van het product is afhankelijk van het product dat u hebt ontvangen. Vergeef ons dat we u niet opnieuw zullen informeren als er technologie- of software-updates voor ons product zijn.

## VEILIGHEIDSINSTRUCTIES

### WAARSCHUWING:

**Lees dit materiaal voordat u dit product gebruikt. Als u dit niet doet, kan dit leiden tot ernstig letsel.**

### Voorzorgsmaatregelen bij de

**montage** 1. Monteer alleen volgens deze instructies. Onjuiste montage kan gevaren creëren.

2. Draag tijdens de montage een ANSI-goedgekeurde veiligheidsbril en stevige werkhandschoenen.

3. Zorg ervoor dat de verzamelplaats schoon en goed verlicht is.

4. Houd omstanders uit de buurt tijdens de montage.

5. Kom niet bijeen als u moe bent of onder invloed van alcohol, drugs of medicijnen.

6. De producteigenschappen gelden uitsluitend voor correct en volledig gemonteerde producten.

7. Monteer op een vlak, egaal, hard en glad oppervlak dat veilig kan worden gebruikt ter ondersteuning van de Box Style Cat Trees.

8. Voor aanvullende informatie over de onderdelen die in de volgende lijst staan vermeld, pagina's, raadpleeg dan het montageschema van deze handleiding. Pak alle onderdelen uit en scheid ze in een schone werkruimte.

### Neem

**voorzorgsmaatregelen** 1. GA NIET OP DIT ITEM ZITTEN OF STAAN.

2. Dit product is geen speelgoed. Laat kinderen niet met of in de buurt van dit product spelen. item.

3. Overschrijd het aangegeven draagvermogen niet.





4. Gebruik het alleen op een vlak, egaal, hard en glad oppervlak dat veilig kan worden gebruikt. ondersteunen een volledig uitgeruste Box Style kattenboom.

5. Gebruik het product alleen zoals bedoeld.



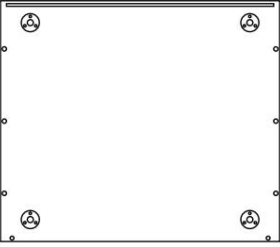
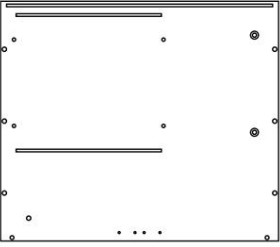
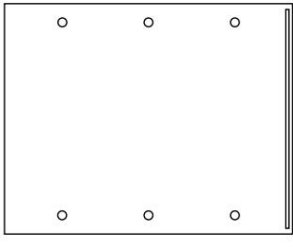
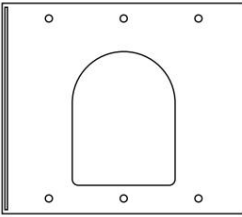
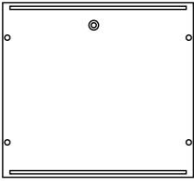
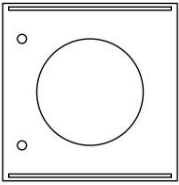
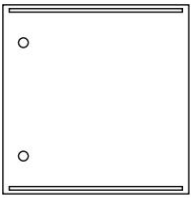
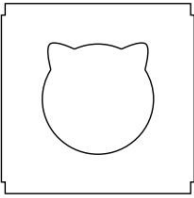
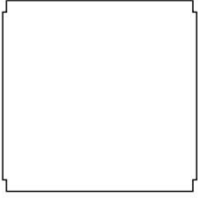

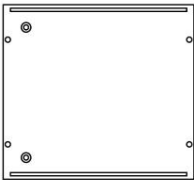
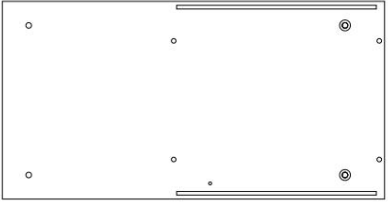
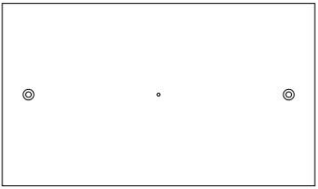
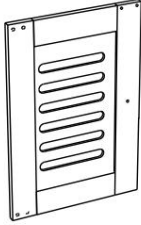
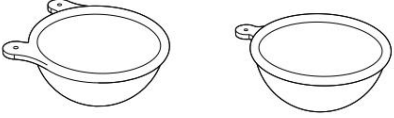









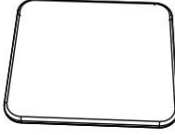

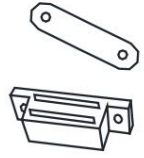

6. Controleer het apparaat voor elk gebruik. Gebruik het niet als er onderdelen loszitten of beschadigd zijn.

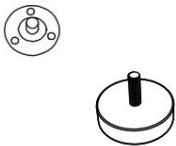
### BEWAAR DEZE HANDLEIDING

## Accessoires tafel

		
Eenx1	Bx1	Cx1
		
Dx1	Ex1	Fx2
		
Gx2	Hx2	Ix2
		
Jx1	Kx1	Lx1
		
Mx1	Nx2	O1x1 O2x1
	*Elke set wordt geleverd met een schroevendraaier en een sleutel	

# Accessoires tafel

<p>(Sisal zuilen) 30cm</p>  <p>1 x1</p>	<p>(De kolom omwikkelen) 30cm</p>  <p>2 x6</p>	<p>37cm</p>  <p>3 x2</p>
<p>(kussen)</p>  <p>4 x1</p>	<p>(kussen)</p>  <p>5 x2</p>	<p>(Lente speelgoed)</p>  <p>Sx2</p>
<p>(deurknop) (Deurstopper) (Pluizebal speelgoed) (Anti-kantel touw) (Draaibare as)</p>		
 <p>Ux2</p>  <p>Vx2</p>	 <p>Xx1</p>  <p>Breedte x 1</p>	 <p>Jaar x 4</p>
<p>(Verstelbare voetensteun)</p>  <p>Zx4</p>	<p>(3-in-1 schroeven)</p>  <p>Q1x20</p>	<p>(M6*40)</p>  <p>Q2x8</p> <p>(M4*22)</p>  <p>Q3x2</p>
<p>(M4*12)</p>  <p>T1x12</p>	<p>(M8*30)</p>  <p>T2x10</p>	<p>(M8*70)</p>  <p>T3x4</p> <p>(M3*12)</p>  <p>T4x16</p>

# Installatiestappen

## Stap 1

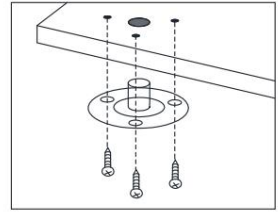
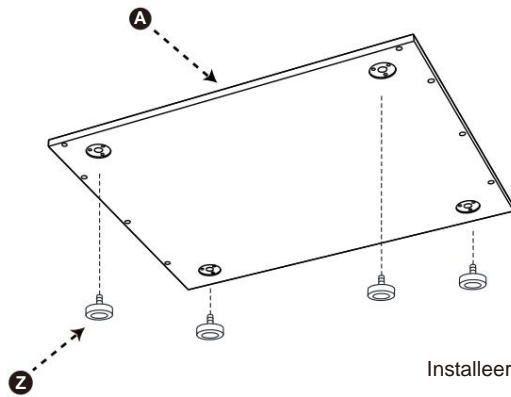

Installeer de verstelbare voetplaat op de basis zoals afgebeeld;

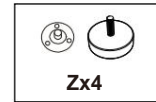
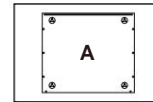

## Stap 2

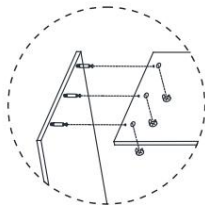

De drie-in-één schroefinstallatiemethode wordt weergegeven in de afbeelding;

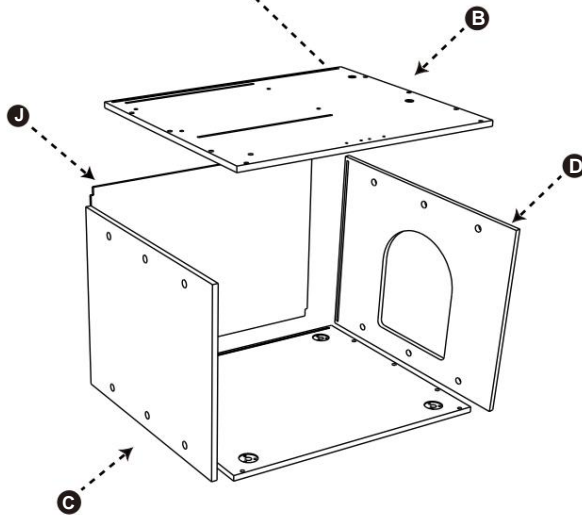

Monteer eerst het onderste kastje zoals aangegeven in de afbeelding;

(Let op: Lijn de gaten uit voordat u ze vastdraait)

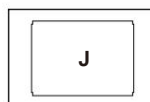
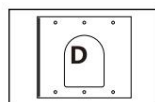
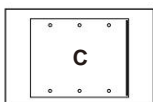
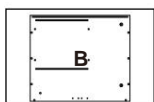

## Stap 3

Monteer de bijbehorende deurstopper en de kleine zwarte neus U zoals afgebeeld in de afbeelding;

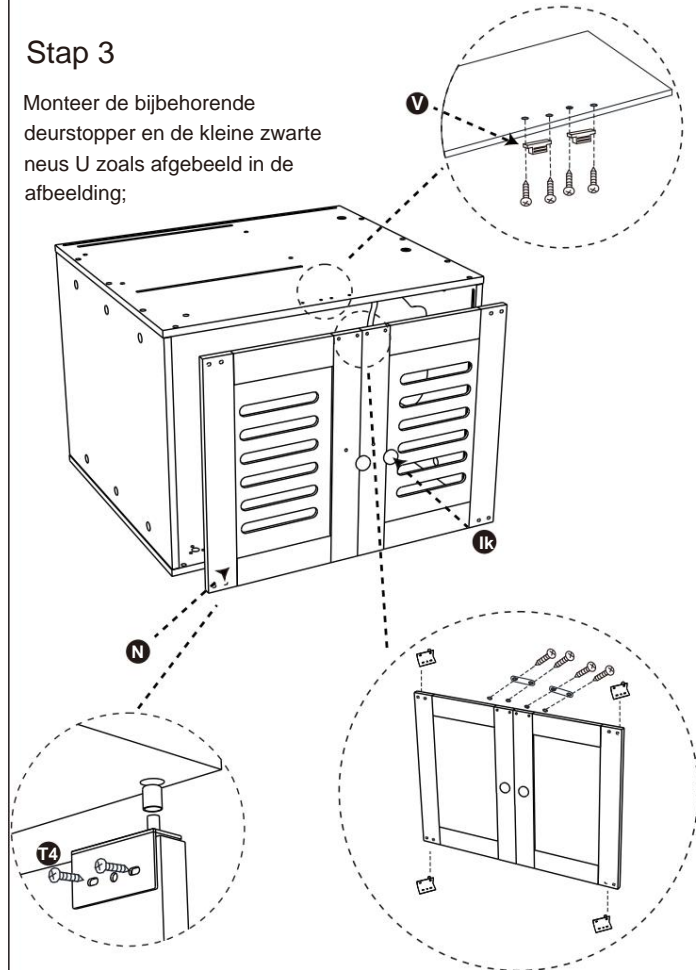

Plaats eerst de spindelplaat en plaats daarna het scharnier  
Plaats op de deur en draai de schroeven vast;

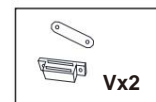
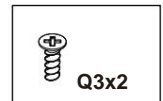
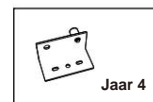

Stap 4

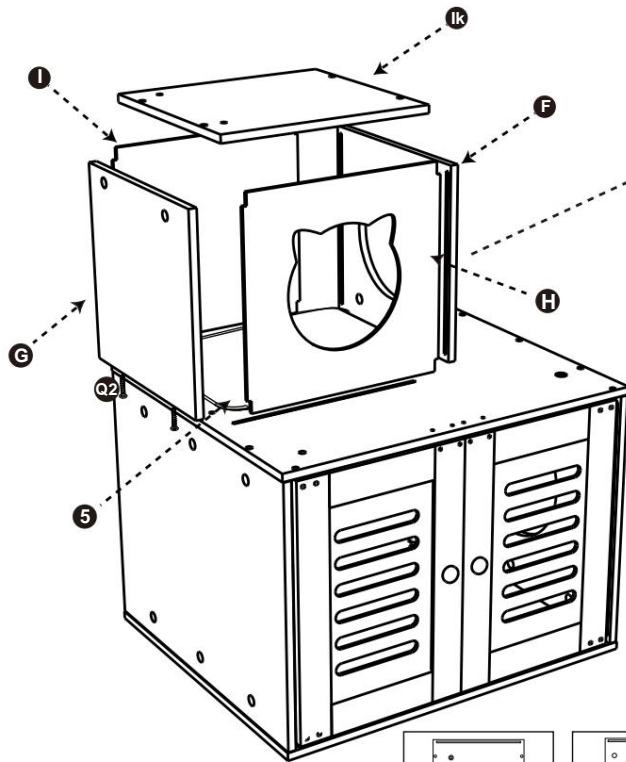

Plaats de I-plaat en de H-plaat in de bovenste groef van de kast;

Monteer het kattennest boven het kastje zoals aangegeven in de afbeelding en leg er tenslotte de mat 5 op;

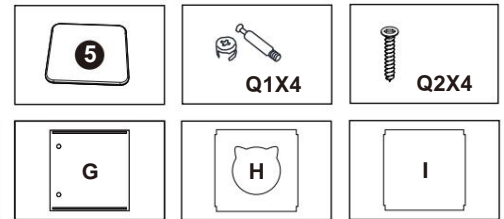

Stap 5

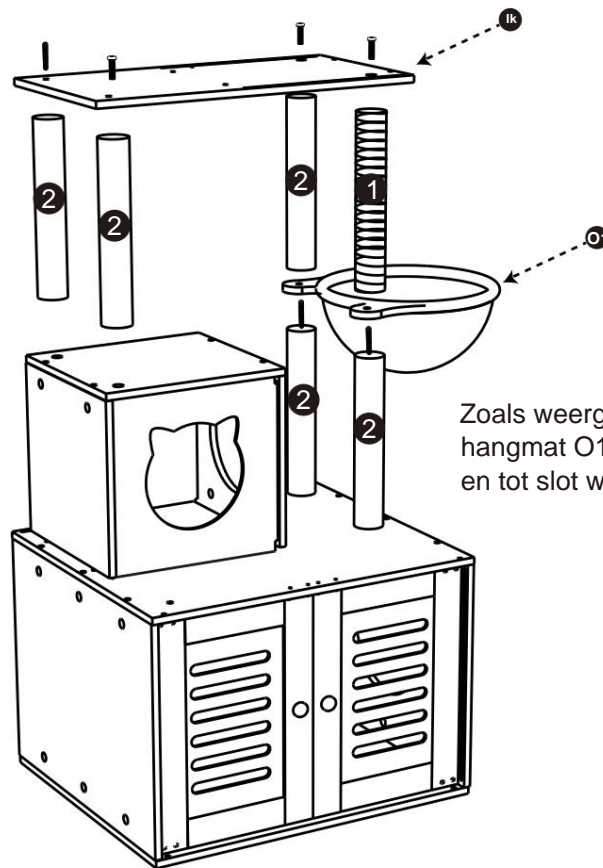

Zoals weergegeven in de afbeelding worden de hangmat O1 en de bijbehorende kolom geïnstalleerd en tot slot wordt het houten bord L geïnstalleerd;

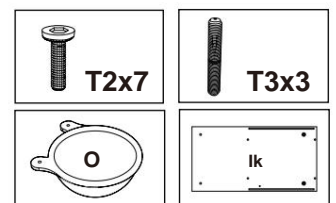

Stap 6

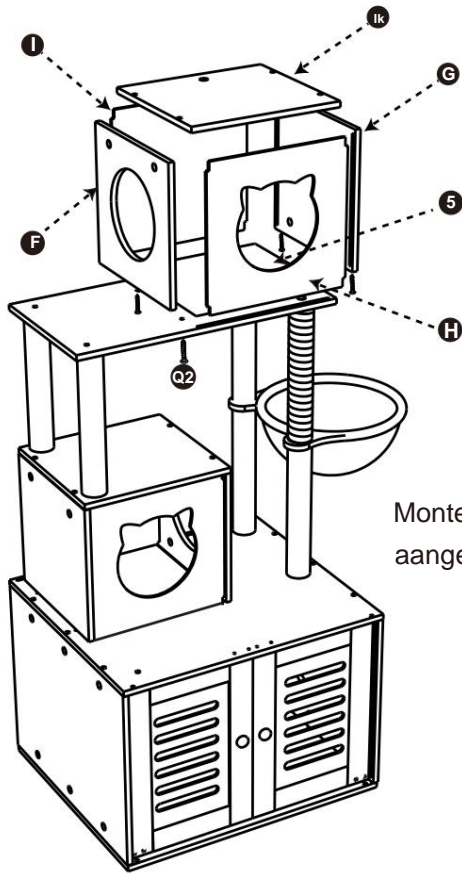

Monteer nog een kattennest op het kastje zoals aangegeven in de afbeelding en leg er tenslotte de mat 5 in;

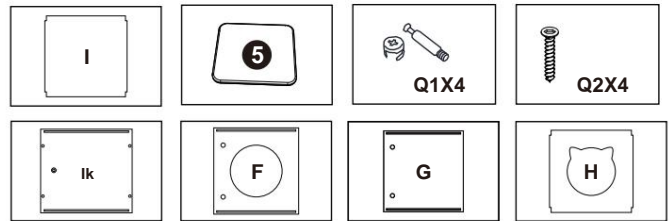

Stap 7

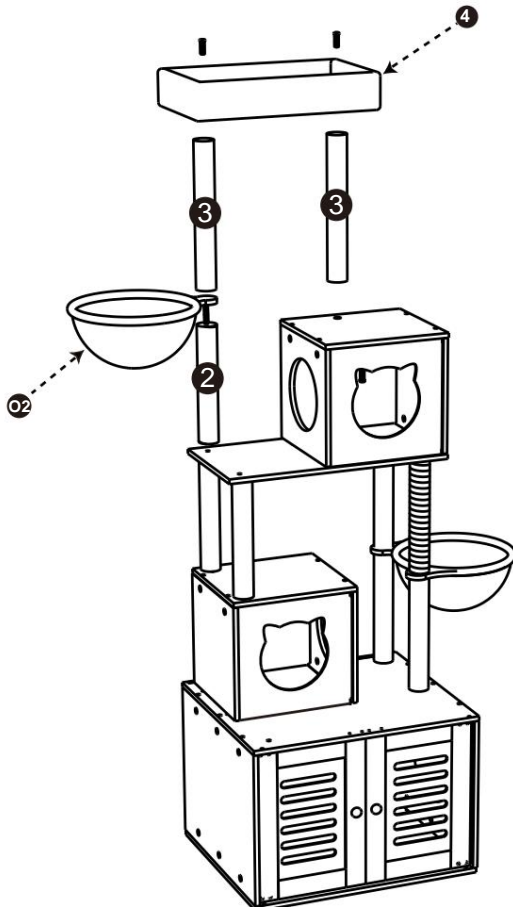

Zoals weergegeven in de afbeelding worden de hangmat O2 en de bijbehorende kolom geïnstalleerd en tenslotte wordt de mat 4 geïnstalleerd;

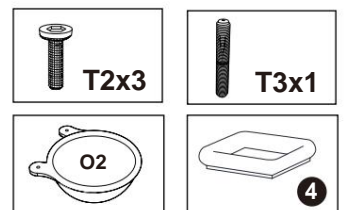

## Stap 8

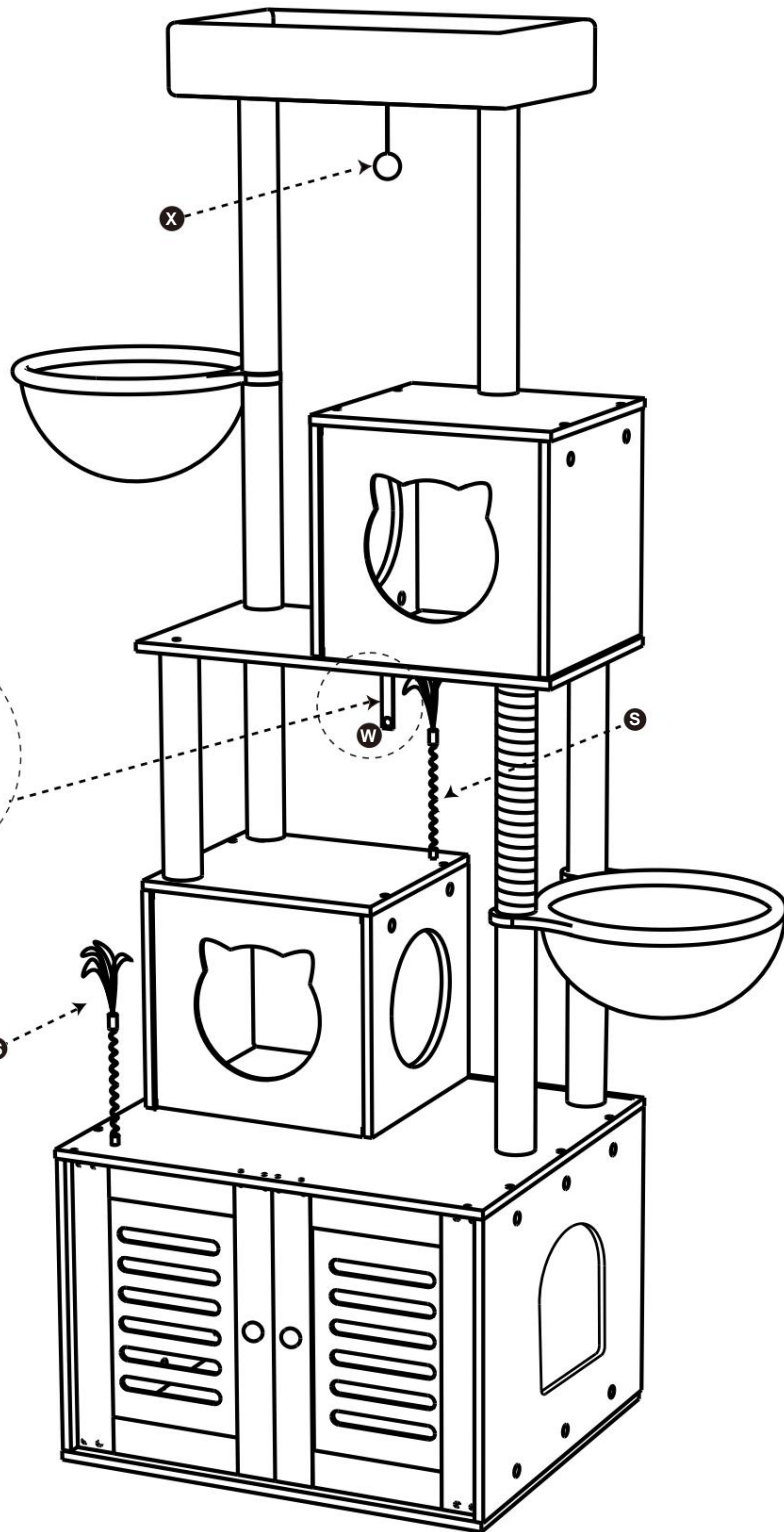

Steek de expansiebuis in de muur en bevestig het anti-kantelkoord met zelftappende draad aan de muur. Bevestig ten slotte de andere kant met schroeven aan het kattenklimrek.

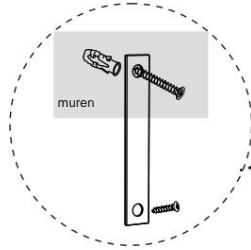

Plaats het haarbal- en veerspeelgoed zoals op de afbeelding is aangegeven en draai het ten slotte vast, zodat de schroeven kunnen worden vastgezet.

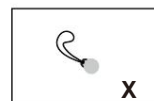

## PRODUCTPARAMETER

<b>Model</b>	SSXG003
<b>Kleur</b>	Grijs
<b>Productgrootte</b>	600*520*1850mm

**Fabrikant:** Shanghai muxinmuyeyouxiangongsi **Adres:**

Shuangchenglu 803nong11hao1602A-1609shi, baoshanqu, shanghai 200000 CN.

**Geïmporteerd naar AUS:** SIHAO PTY LTD. 1 ROKEVA STREET EASTWOOD NSW  
2122 Australië

**Geïmporteerd naar de VS:** Sanven Technology Ltd. Suite 250, 9166 Anaheim Place,  
Rancho Cucamonga, CA 91730



E-CrossStu GmbH

Mainzer Landstr.69, 60329 Frankfurt am Main.



YH CONSULTING LIMITED.

C/O YH Consulting Limited Kantoor 147, Centurion  
Huis, London Road, Staines-upon-Thames, Surrey,  
TW18 4AX

**VEVOR<sup>®</sup>**  
**TOUGH TOOLS, HALF PRICE**

Technische ondersteuning en e-  
garantiecertificaat [www.vevor.com/support](http://www.vevor.com/support)



# **VEVOR<sup>®</sup>**

## **TOUGH TOOLS, HALF PRICE**

Teknisk support och e-garanticertifikat [www.vevor.com/support](http://www.vevor.com/support)

### **KATTTRÄD I LÅDSTYL**

### **ANVÄNDARMANUAL**

Vi fortsätter att vara engagerade i att ge dig verktyg till konkurrenskraftiga priser.

"Spara hälften", "halva priset" eller andra liknande uttryck som används av oss representerar bara en uppskattning av besparingar du kan dra nytta av att köpa vissa verktyg hos oss jämfört med de stora toppmärkena och betyder inte nödvändigtvis att täcka alla kategorier av verktyg som erbjuds av oss. Du påminns vänligen om att noggrant kontrollera när du gör en beställning hos oss om du faktiskt sparar hälften i jämförelse med de främsta stora varumärkena.



# VEVOR®

TOUGH TOOLS, HALF PRICE

KATTTRÄD I LÅDSTYL

MODELL: SSXG003

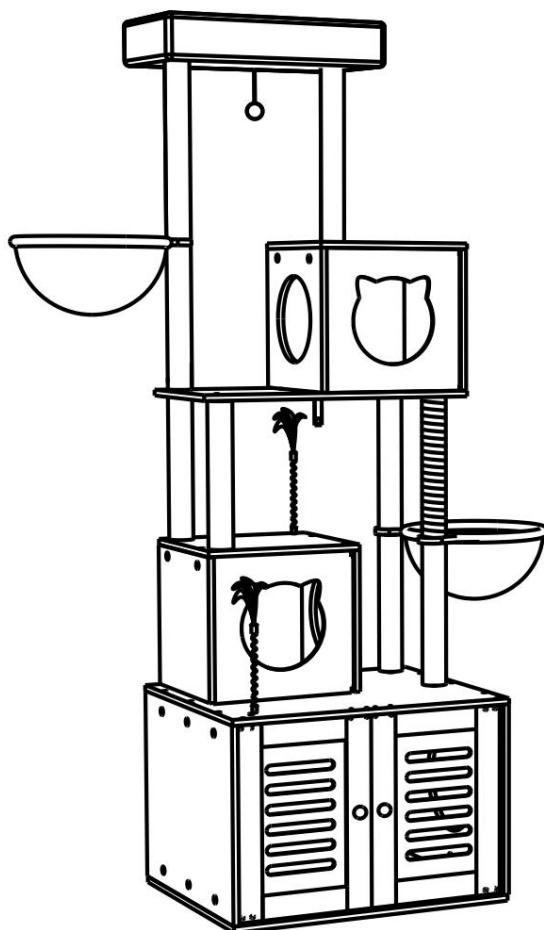

## BEHÖVER HJÄLP? KONTAKTA OSS!

Har du produktfrågor? Behöver du teknisk support? Kontakta oss gärna: Teknisk support och e-garanticertifikat [www.vevor.com/support](http://www.vevor.com/support)

Detta är den ursprungliga instruktionen, läs alla instruktioner noggrant innan du använder den. VEVOR reserverar sig för en tydlig tolkning av vår användarmanual. Utseendet på produkten är beroende av den produkt du fått. Ursäkta oss att vi inte kommer att informera dig igen om det finns någon teknik eller mjukvaruuppdateringar på vår produkt.

## SÄKERHETSINSTRUKTIONER

### **VARNING:**

**Läs detta material innan du använder denna produkt. Underlåtenhet att göra det kan resultera i allvarliga skador.**

### **Försiktighetsåtgärder vid**

**montering** 1. Montera endast enligt dessa instruktioner. Felaktig montering kan skapa faror.

2. Bär ANSI-godkända skyddsglasögon och kraftiga arbetshandskar vid montering.

3. Håll monteringsområdet rent och väl upplyst.

4. Håll åskådare borta från området under monteringen.

5. Sätt dig inte ihop om du är trött eller påverkad av alkohol, droger eller medicin.

6. Produktens funktioner gäller endast för korrekt och färdigmonterade produkter.

7. Montera på en plan, jämn, hård och slät yta som kan säkert stödjer Box Style Cat Trees.

8. För ytterligare information om delarna som anges nedan sidorna, se monteringsdiagrammet i denna manual. Packa upp och separera alla delar på ett rent arbetsområde.

### **Använd**

**försiktighetsåtgärder** 1. SIT ELLER STÅ INTE PÅ DETTA FÖREMÅL.

2. Denna produkt är inte en leksak. Låt inte barn leka med eller i närheten av detta punkt.

3. Överskrid inte specificerade viktkapaciteter.

4. Använd endast på en plan, jämn, hård och slät yta som kan säkert stödja en fullastad Box Style Cat Trees.

5. Använd endast på avsett sätt.

6. Inspektera före varje användning; Använd inte om delar är lösa eller skadade.

### **SPARA DENNA MANUAL**

# Tillbehörsbord

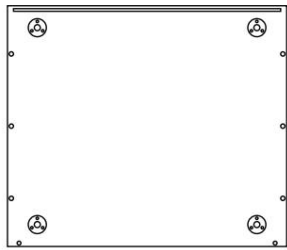

Ax1

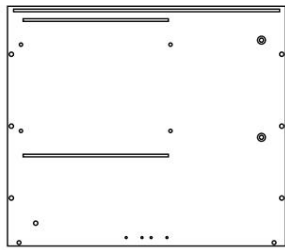

Bx1

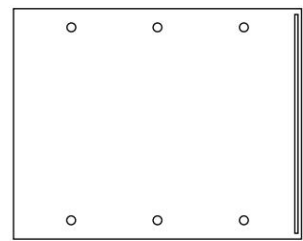

Cx1

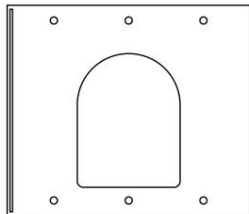

Dx1

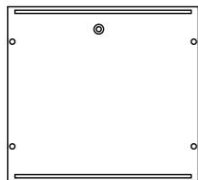

Ex1

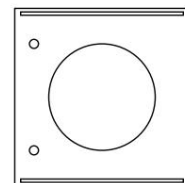

Fx2

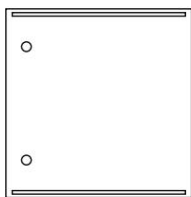

Gx2

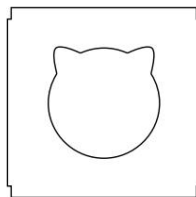

Hx2

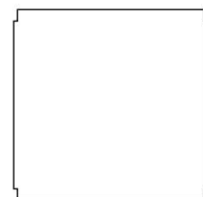

Ix2



Jx1

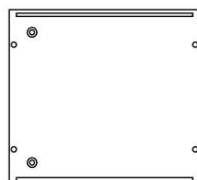

Kx1

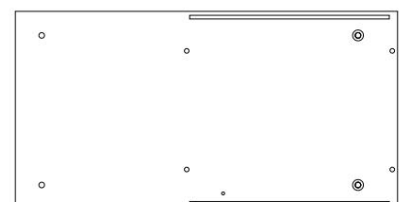

Lx1

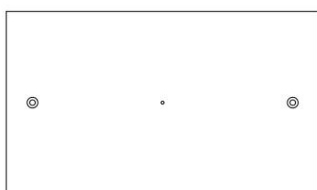

Mx1

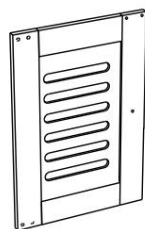

Nx2

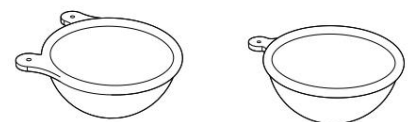















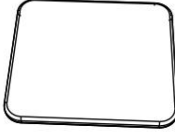

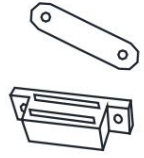



O1x1

O2x1



\* Varje set levereras med en skruvmejsel och skiftnyckel

# Tillbehörsbord

<p>(Sisalpelare) 30cm</p>  <p>1 x1</p>	<p>(Slå in kolumnen) 30 cm</p>  <p>2 x6</p>	<p>37 cm</p>  <p>3 x2</p>
<p>(dämpa)</p>  <p>4 x1</p>	<p>(dämpa)</p>  <p>5 x2</p>	<p>(Vårleksaker)</p>  <p>Sx2</p>
<p>(dörrhandtag) (Dörrstoppare)</p>  <p>Ux2</p>  <p>Vx2</p>	<p>(Furball-leksaker) (Tipprep) (Roterande axel)</p>  <p>Xx1</p>  <p>Bx1</p>	 <p>Yx4</p>
<p>(Justerbart fotstöd)</p>  <p>Zx4</p> 	<p>(3-i-1 skruvar)</p>  <p>Q1x20</p> 	<p>(M6*40) (M4*22)</p>  <p>Q2x8</p>  <p>Q3x2</p>
<p>(M4*12)</p>  <p>T1 x12</p>	<p>(M8*30)</p>  <p>T2 x10</p>	<p>(M8*70) (M3*12)</p>  <p>T3 x4</p>  <p>T4 x16</p>

# Installationssteg

## Steg 1

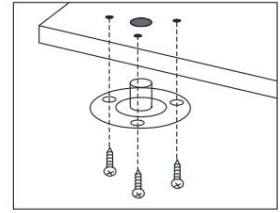
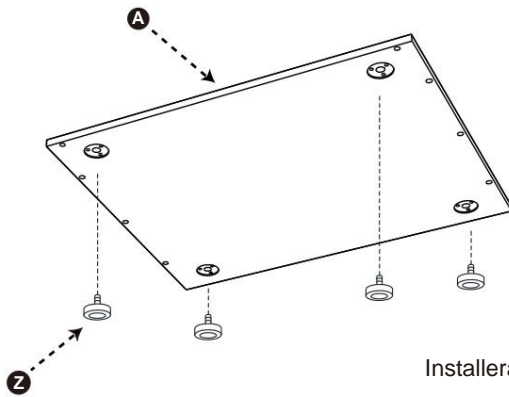

Installera den justerbara fotplattan på basen enligt bilden;

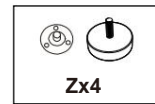
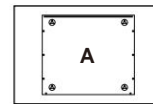

## Steg 2

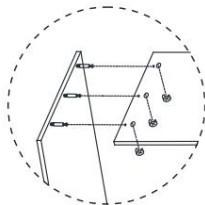

Metoden för montering av tre-i-ett-skruv visas i figuren;

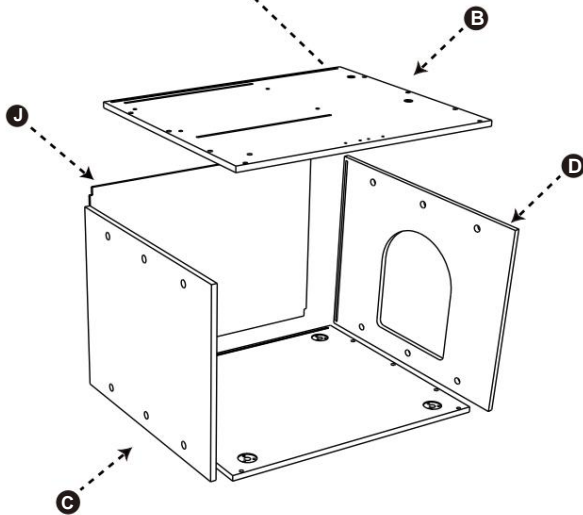

Montera bottenkåpet först enligt bilden;

ÖObs: Rikta in hålen innan du drar åt

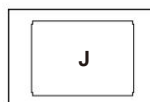
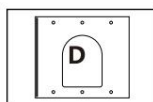
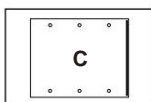
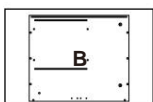

## Steg 3

Som visas i figuren, montera motsvarande dörrstoppare och den lilla svarta nosen U;

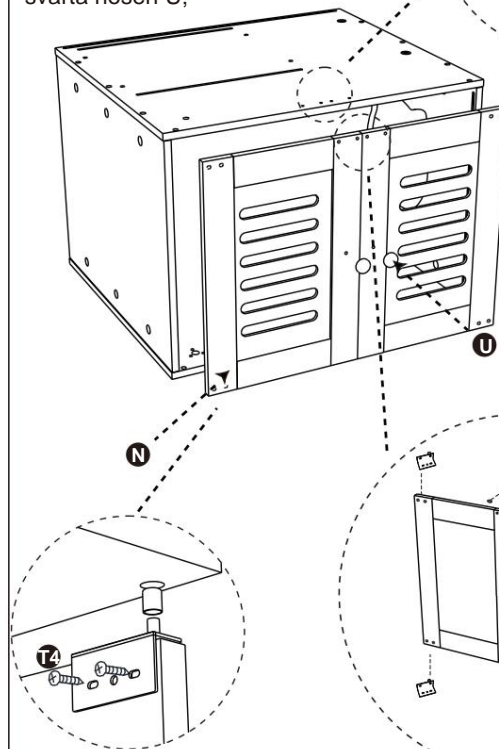
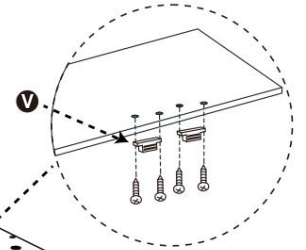

Sätt spindelplattan först och sätt sedan gångjärnet  
Placera på dörren och dra åt skruvarna;

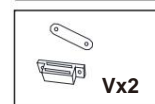
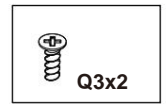

## Steg 4

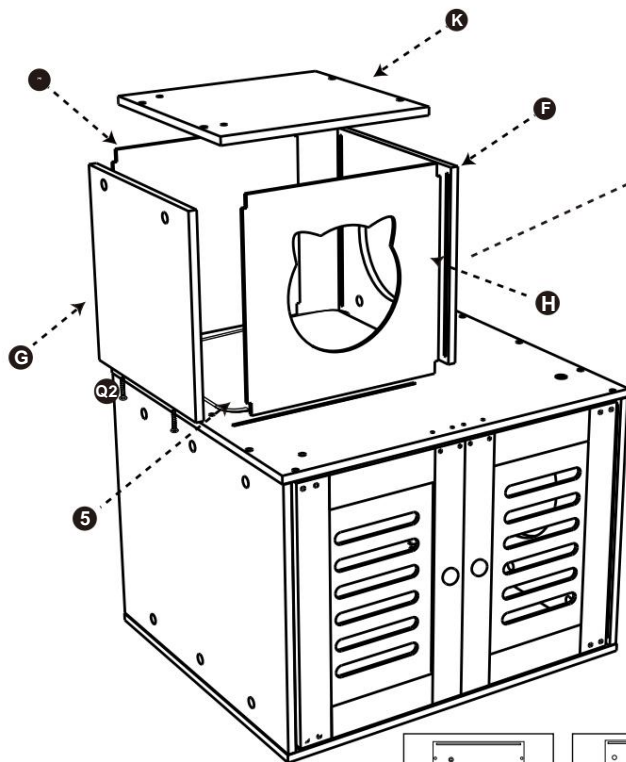

Sätt in I-plattan och H-plattan i skåpets övre skåra;

Sätt ihop kattboet ovanför skåpet enligt bilden och lägg slutligen på mattan 5;

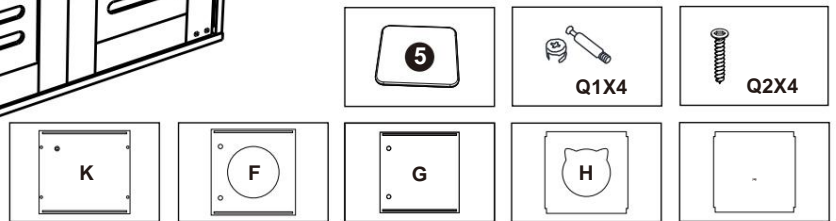

## Steg 5

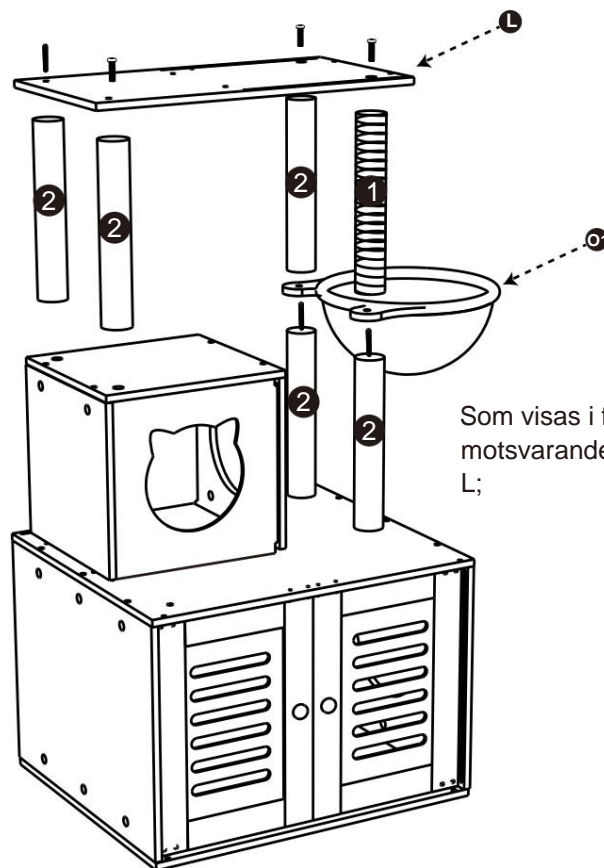

Som visas i figuren installeras hängmattan O1 och motsvarande kolumn, och slutligen installeras träskivan L;

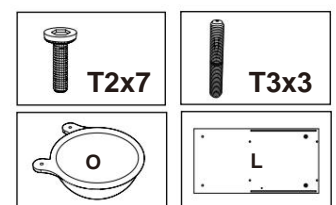

## Steg 6

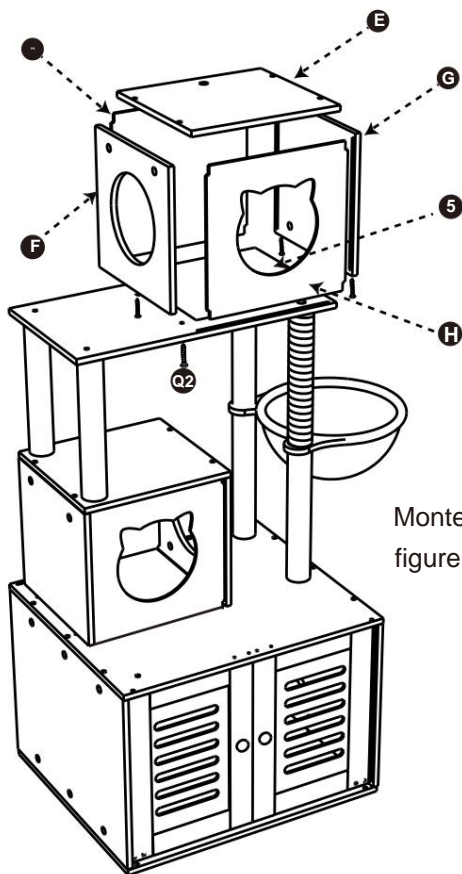

Montera ytterligare ett kattbo på skåpet som visas i figuren, och lägg slutligen mattan 5 i det;

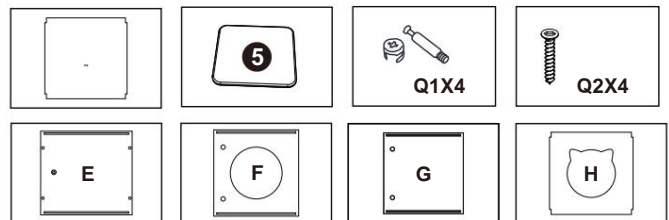

## Steg 7

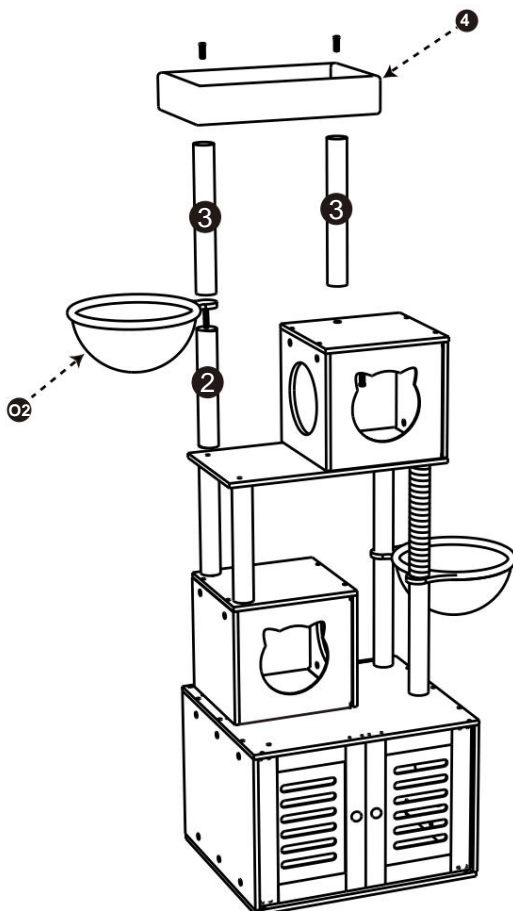

Som visas i figuren installeras hängmattan O2 och motsvarande pelare, och slutligen installeras mattan 4;

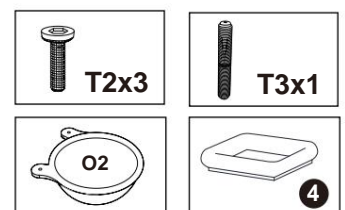

## Steg 8

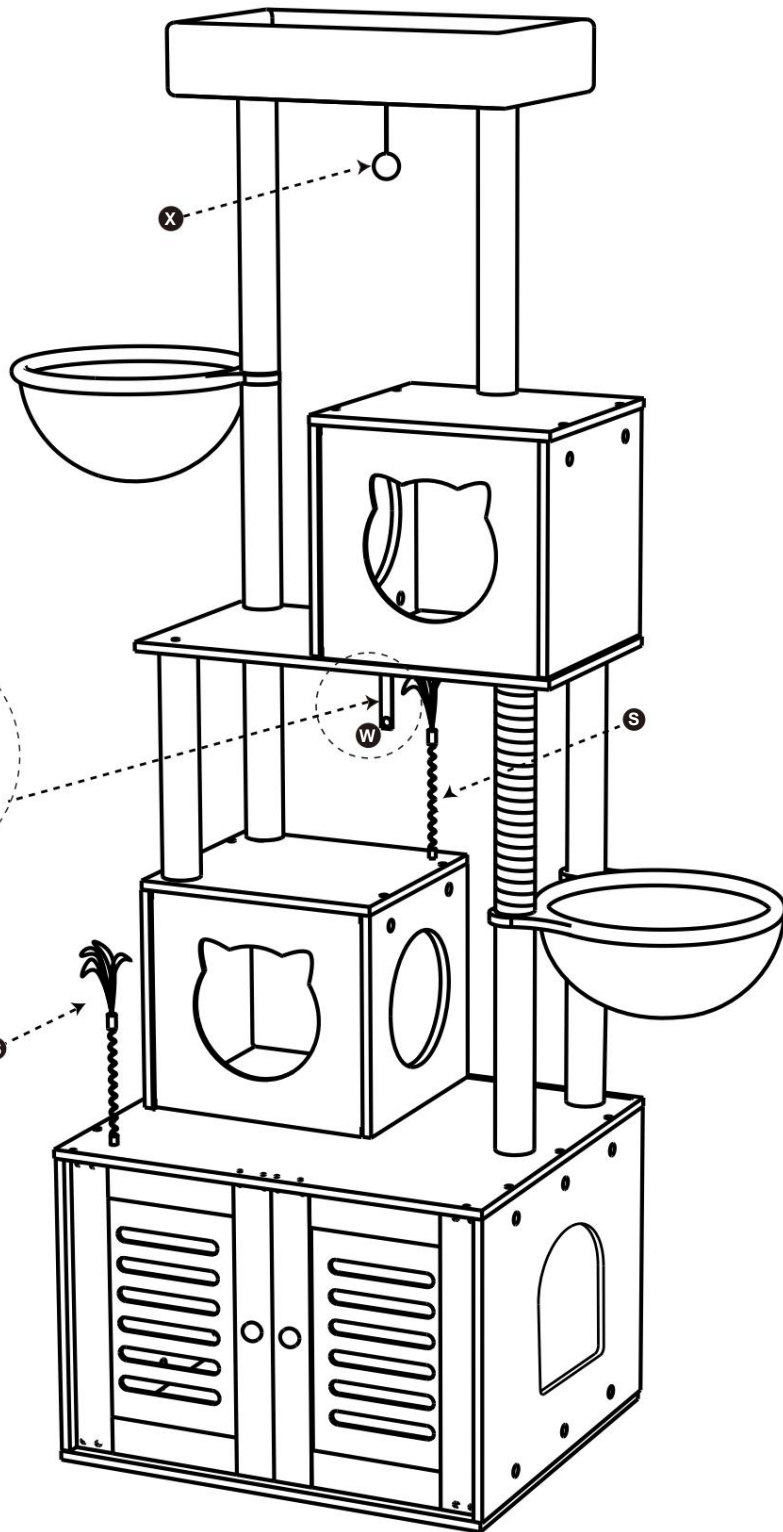

Koppla in expansionsröret i väggen och fäst sedan tipskyddet på väggen med självgående tråd; Använd slutligen skruvar för att fästa den andra sidan på kattens klätterställning.

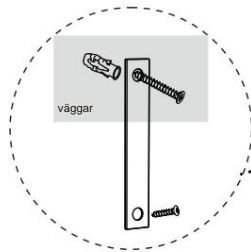

Montera hårbollsleksaken och fjäderleksaken som visas på bilden och dra till sist åt den så att skruvarna kan fixeras.

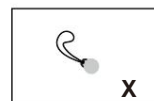

## PRODUKTPARAMETER

<b>Modell</b>	SSXG003
<b>Färg</b>	Grå
<b>Produktstorlek</b>	600*520*1850 mm

**Tillverkare:** Shanghaimuxinmuyeyouxiangongsi **Adress:**

Shuangchenglu 803nong11hao1602A-1609shi, baoshanqu, shanghai 200000 CN.

**Importerad till AUS:** SIHAO PTY LTD. 1 ROKEVA STREETEASTWOOD NSW 2122  
Australien

**Importerad till USA:** Sanven Technology Ltd. Suite 250, 9166 Anaheim Place, Rancho  
Cucamonga, CA 91730



E-CrossStu GmbH

Mainzer Landstr.69, 60329 Frankfurt am Main.



YH CONSULTING LIMITED.

C/O YH Consulting Limited Office 147, Centurion  
House, London Road, Staines-upon-Thames, Surrey,  
TW18 4AX

**VEVOR**<sup>®</sup>  
**TOUGH TOOLS, HALF PRICE**

**Teknisk support och e-garanticertifikat**  
**[www.vevor.com/support](http://www.vevor.com/support)**



# **VEVOR<sup>®</sup>**

## **TOUGH TOOLS, HALF PRICE**

Soporte técnico y certificado de garantía electrónica [www.vevor.com/support](http://www.vevor.com/support)

### **ÁRBOLES PARA GATOS ESTILO CAJA**

### **MANUAL DEL USUARIO**

Seguimos comprometidos a brindarle herramientas a precios competitivos.

"Ahorre la mitad", "mitad de precio" o cualquier otra expresión similar que utilicemos solo representa una estimación del ahorro que podría obtener al comprar ciertas herramientas con nosotros en comparación con las principales marcas y no necesariamente significa que cubra todas las categorías de herramientas que ofrecemos. Le recordamos que, al realizar un pedido con nosotros, verifique cuidadosamente si realmente está ahorrando la mitad en comparación con las principales marcas.



**VEVOR**<sup>®</sup>  
TOUGH TOOLS, HALF PRICE

ÁRBOLES PARA GATOS ESTILO CAJA

MODELO:SSXG003

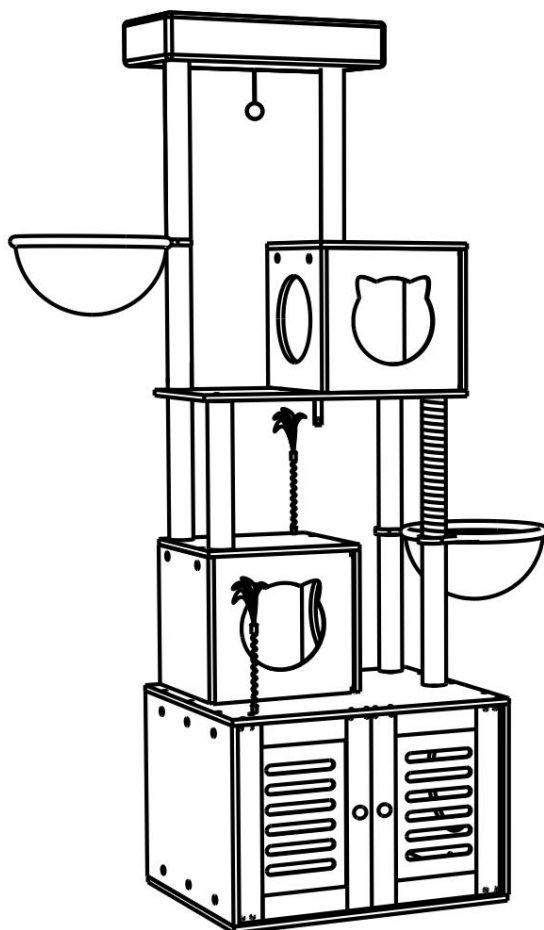

¿NECESITA AYUDA? ¡CONTÁCTENOS!

¿Tiene preguntas sobre el producto? ¿Necesita asistencia técnica? No dude en ponerse en contacto con nosotros: Asistencia técnica y certificado de garantía electrónica [www.vevor.com/support](http://www.vevor.com/support)

Estas son las instrucciones originales, lea atentamente todas las instrucciones del manual antes de utilizar el producto. VEVOR se reserva una interpretación clara de nuestro manual de usuario.

La apariencia del producto estará sujeta al producto que recibió. Perdónenos por no informarle nuevamente si hay actualizaciones de tecnología o software en nuestro producto.

## INSTRUCCIONES DE SEGURIDAD

### ADVERTENCIA:

Lea este material antes de utilizar este producto. No hacerlo puede provocar lesiones graves.

### Precauciones de montaje 1. Realice

el montaje únicamente de acuerdo con estas instrucciones. Un montaje incorrecto puede crear peligros

2. Use gafas de seguridad aprobadas por ANSI y guantes de trabajo resistentes durante el montaje.

3. Mantenga el área de reunión limpia y bien iluminada.

4. Mantenga a los transeúntes fuera del área durante el montaje.

5. No se reúna si está cansado o bajo la influencia del alcohol, drogas o medicamentos.

6. Las capacidades del producto se aplican únicamente a productos ensamblados de forma correcta y completa.

7. Montar sobre una superficie plana, nivelada, dura y lisa capaz de soportar cargas de forma segura. Apoyando los árboles para gatos estilo caja.

8. Para obtener información adicional sobre las piezas enumeradas a continuación, páginas, consulte el diagrama de ensamblaje de este manual. Desembale y separe todas las piezas en un área de trabajo limpia.

### Precauciones de uso 1.

**NO SE SIENTA NI SE PARE SOBRE ESTE ARTÍCULO.**

2. Este producto no es un juguete. No permita que los niños jueguen con él o cerca de él. artículo.

3. No exceda las capacidades de peso especificadas.



4. Úselo únicamente sobre una superficie plana, nivelada, dura y lisa que pueda Admite árboles para gatos tipo caja completamente cargados.

5. Utilícelo únicamente según lo previsto.

6. Inspeccione antes de cada uso; no utilice si las piezas están sueltas o dañadas.

**GUARDE ESTE MANUAL**

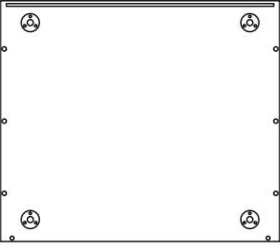
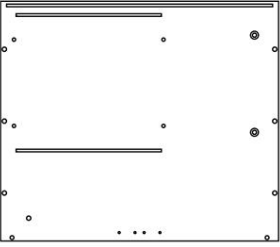
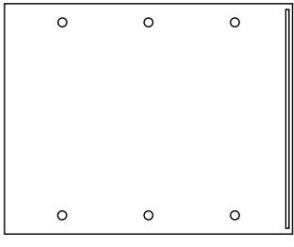
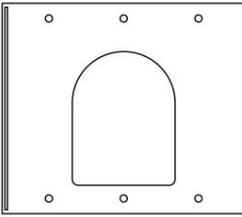
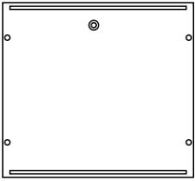
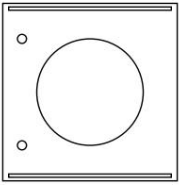
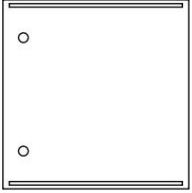
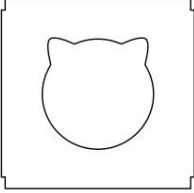
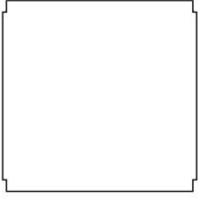

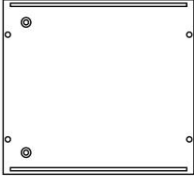
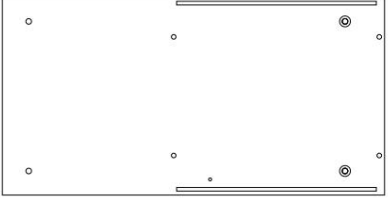
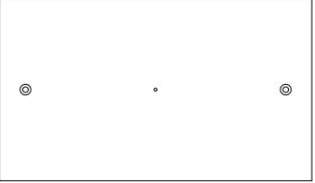
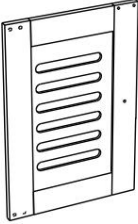
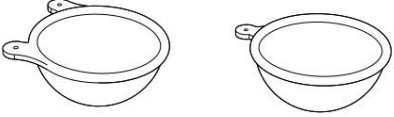











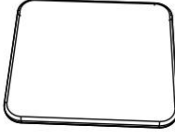

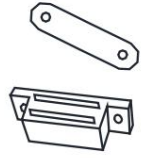

# Mesa de accesorios

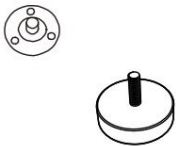
 <p>A×1</p>	 <p>B×1</p>	 <p>C×1</p>
 <p>D×1</p>	 <p>E×1</p>	 <p>F×2</p>
 <p>G×2</p>	 <p>H×2</p>	 <p>Yo × 2</p>
 <p>J×1</p>	 <p>K×1</p>	 <p>L×1</p>
 <p>M×1</p>	 <p>N×2</p>	 <p>O1×1      O2×1</p>



\*Cada juego viene con un destornillador y una llave.

## Mesa de accesorios

<p>(Columnas de sisal)</p> <p>30cm</p>  <p>1 x1</p>	<p>(Envolver la columna)</p> <p>30 centímetros</p>  <p>2 x6</p>	<p>37 centímetros</p>  <p>3 x2</p>
<p>(almohadón)</p>  <p>4 x1</p>	<p>(almohadón)</p>  <p>5 x2</p>	<p>(Juguetes de primavera)</p>  <p>S x2</p>
<p>(pomo de la puerta)</p>  <p>U x2</p>	<p>(Tope de puerta)</p>  <p>V x2</p>	<p>(Juguetes con bolas de pelo) (Cuerda antivuelco) (Eje giratorio)</p>  <p>X x1</p>  <p>An x 1</p>  <p>Y x4</p>
<p>(Reposapiés ajustable)</p>  <p>Z x4</p>	<p>(Tornillos 3 en 1)</p>   <p>Q1 x20</p>	<p>(M6*40)</p>  <p>Q2 x8</p> <p>(M4*22)</p>  <p>Q3 x2</p>
<p>(M4*12)</p>  <p>T1 x12</p>	<p>(M8*30)</p>  <p>T2 x10</p>	<p>(M8*70)</p>  <p>T3 x4</p> <p>(M3*12)</p>  <p>T4 x16</p>

# Pasos de instalación

## Paso 1

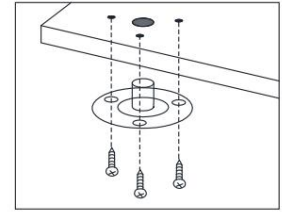
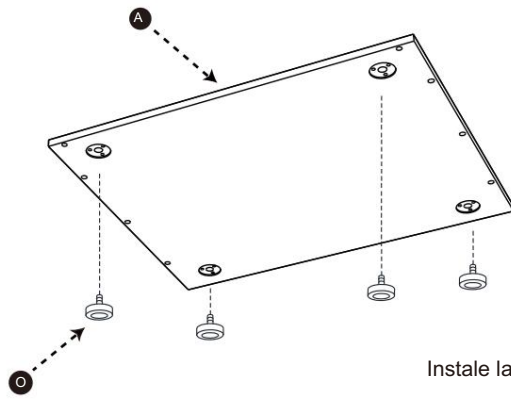

Instale la almohadilla de pie ajustable en la base como se ilustra;

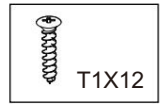
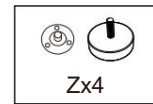
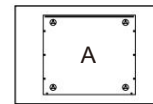

## Paso 2

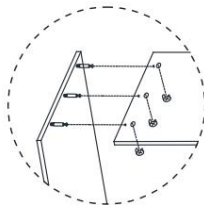

El método de instalación de tornillos tres en uno se muestra en la figura;

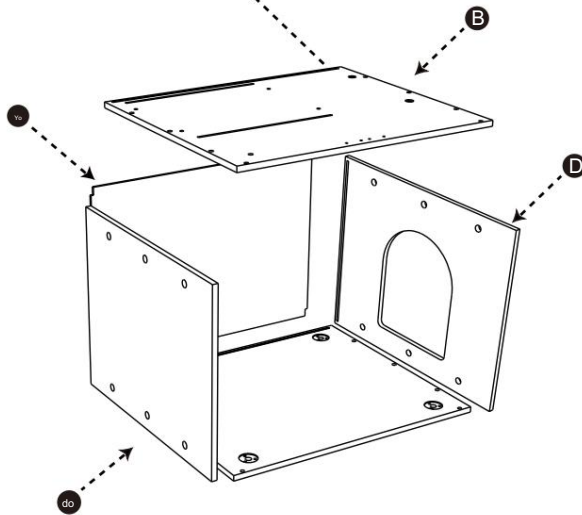

Primero ensamble el gabinete inferior como se muestra en la figura;

Nota: Alinee los orificios antes de apretar

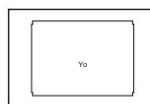
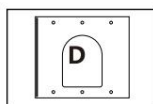
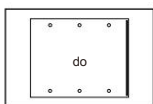
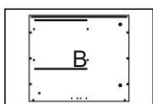

## Paso 3

Como se muestra en la figura, ensamble el tope de puerta correspondiente y la pequeña nariz negra U;

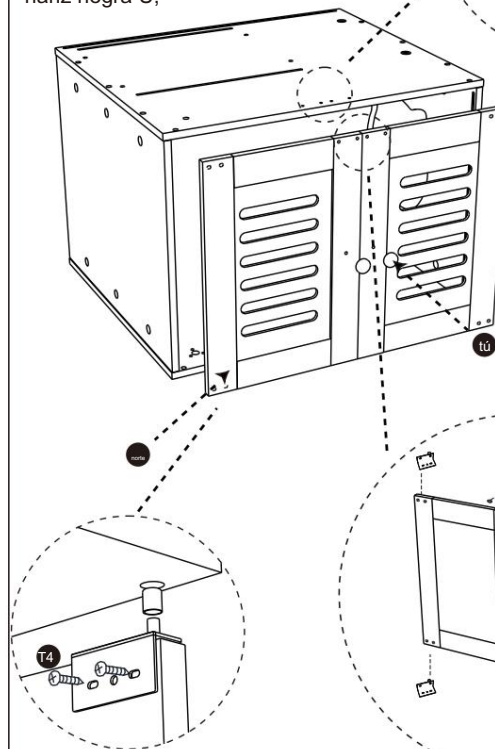
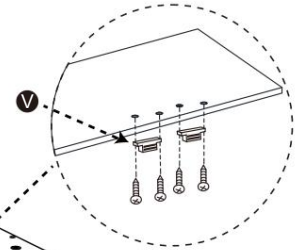

Coloque primero la placa del husillo y luego coloque la bisagra. Colocar en la puerta y apretar los tornillos;

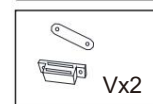
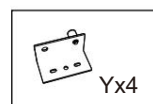
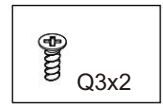
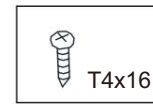

Paso 4

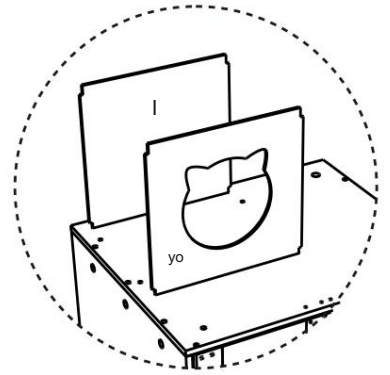
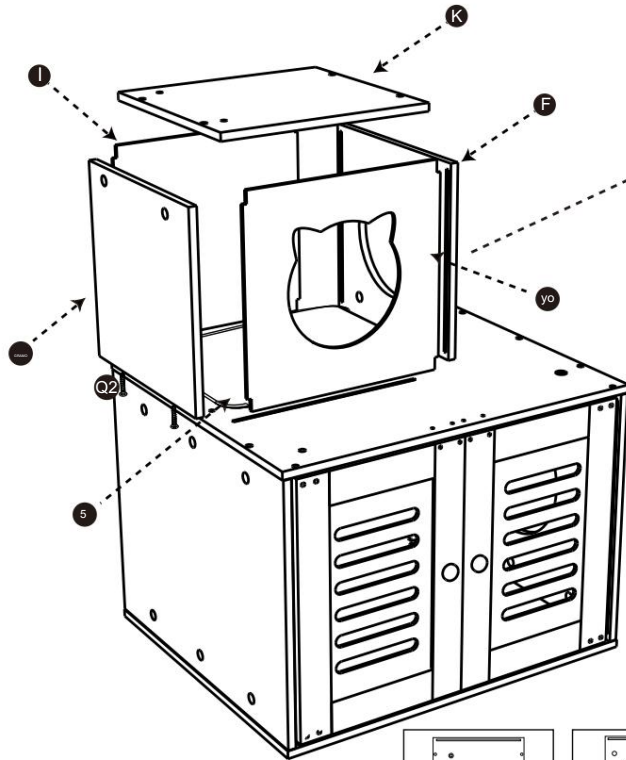

Inserte la placa L y la placa H en la ranura superior del gabinete;

Monte el nido para gatos encima del mueble como se muestra en la figura y finalmente coloque la alfombra 5;

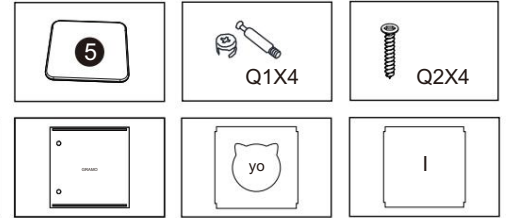

Paso 5

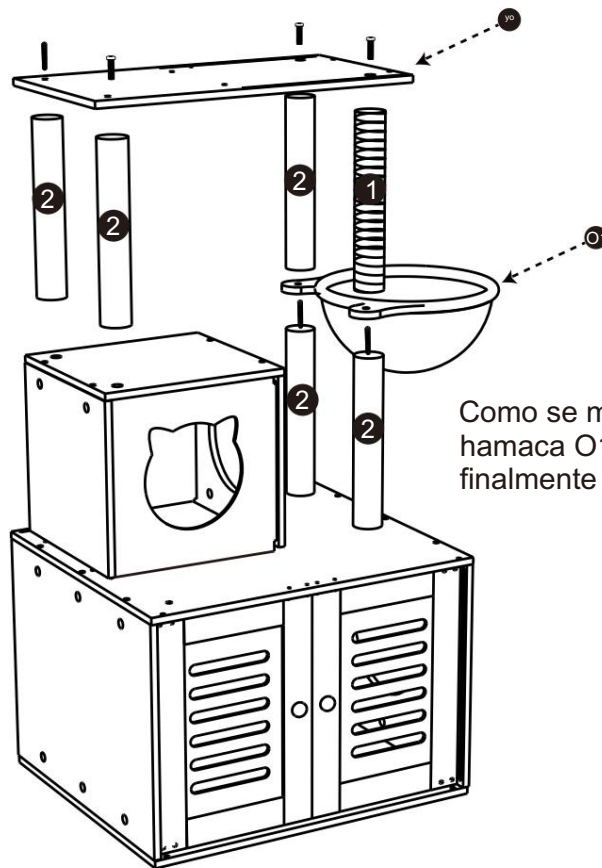

Como se muestra en la figura, se instala la hamaca O1 y la columna correspondiente, y finalmente se instala la tabla de madera L;

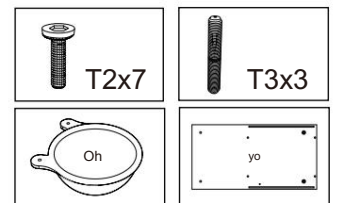

Paso 6

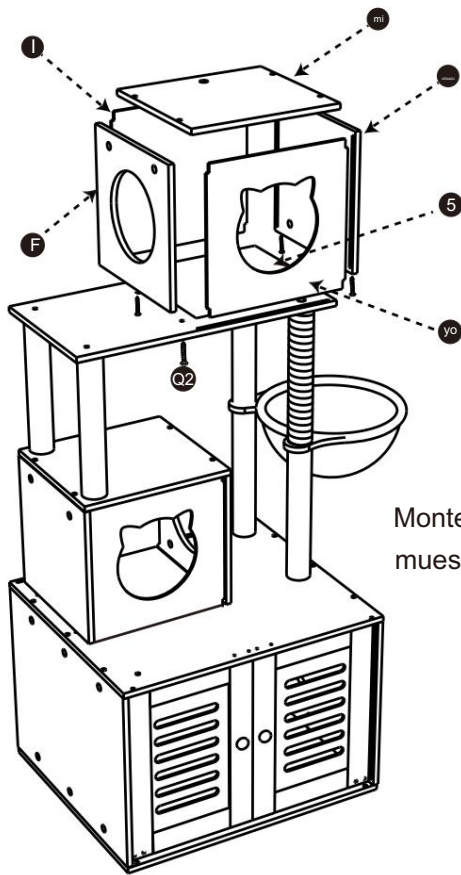

Monte otro nido para gatos en el mueble como se muestra en la figura y, por último, coloque la alfombra 5 en él;

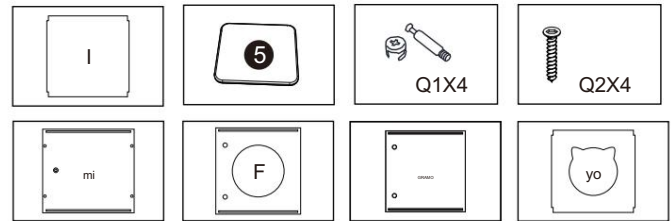

Paso 7

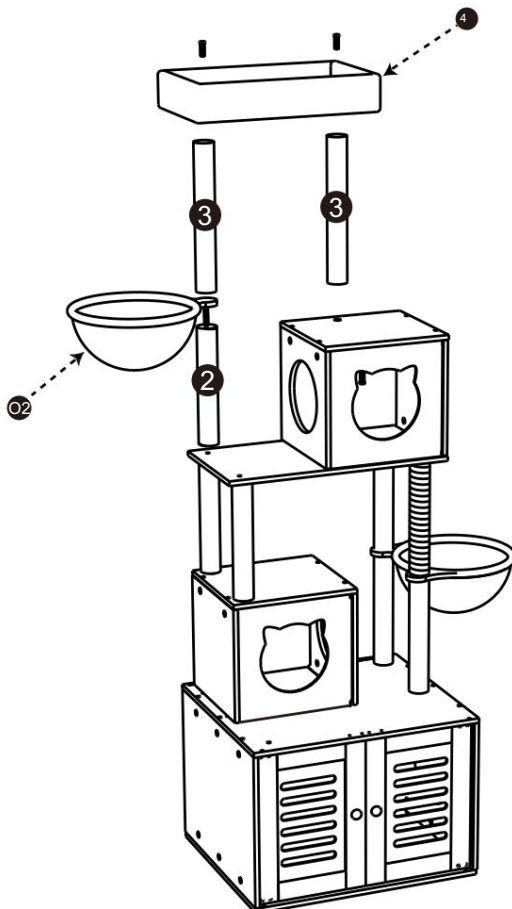

Como se muestra en la figura, se instala la hamaca O2 y la columna correspondiente, y finalmente se instala la colchoneta 4;

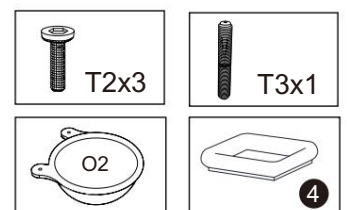

## Paso 8

Conecte el tubo de expansión a la pared y luego fije la cuerda antivuelco en la pared con un cable autorroscante; finalmente, use tornillos para fijar el otro lado al marco de escalada para gatos.

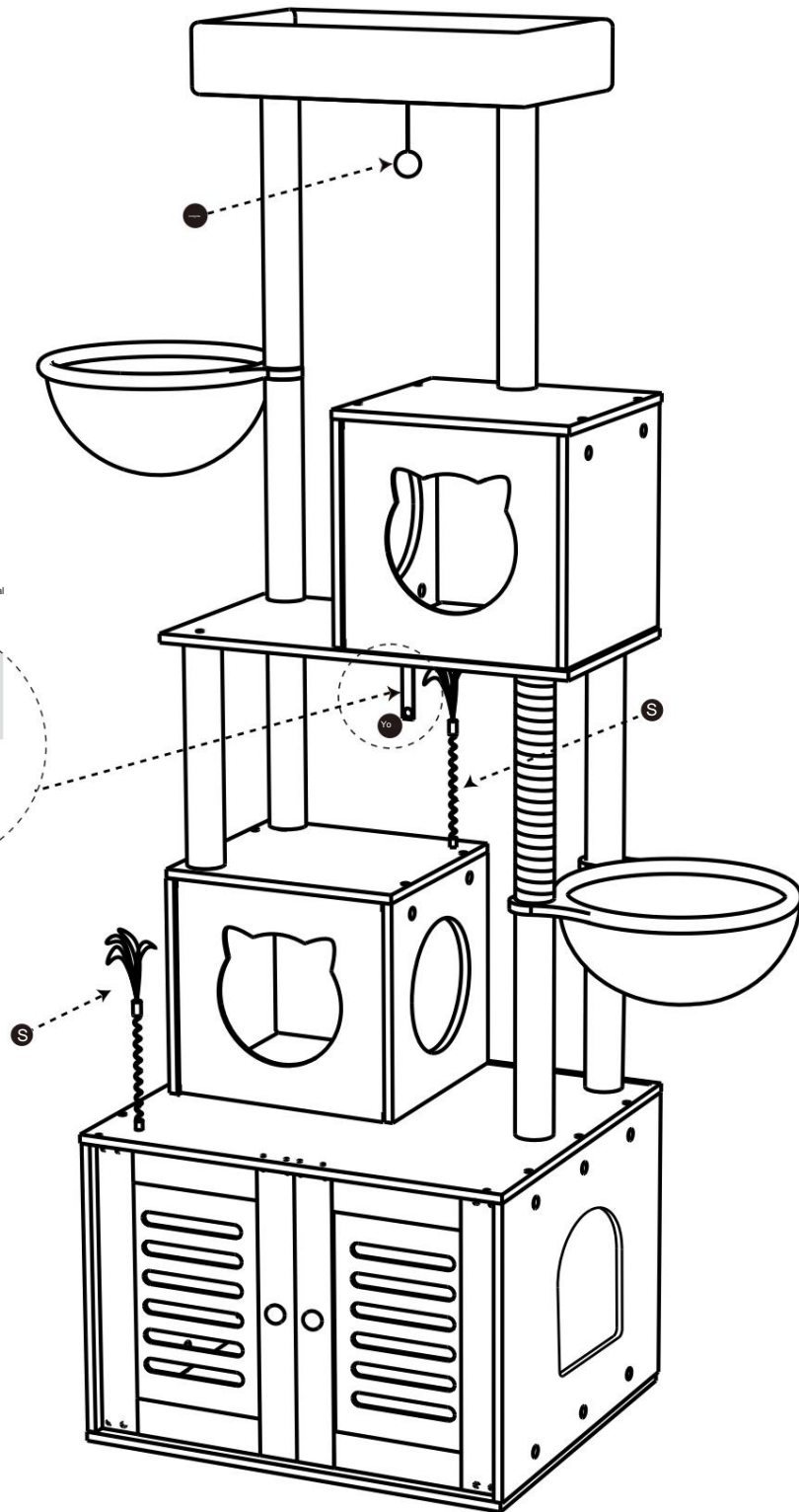
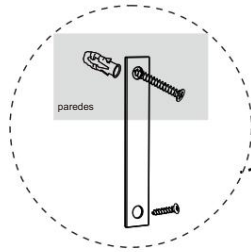

Instale el juguete de bola de pelo y el juguete de resorte como se muestra en la imagen y, finalmente, apriételo para que se puedan fijar los tornillos.

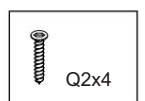
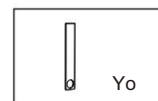
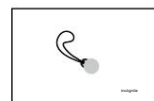
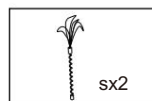

PARÁMETRO DEL PRODUCTO

Modelo	SSXG003
Color	Gris
Tamaño del producto	600*520*1850 mm

Fabricante: Shanghaimuxinmuyeyouxiangongsi Dirección:  
Shuangchenglu 803nong11hao1602A-1609shi, baoshanqu, shanghai 200000 CN.

Importado a AUS: SIHAO PTY LTD. 1 ROKEVA STREETEASTWOOD NSW 2122  
Australia

Importado a EE. UU.: Sanven Technology Ltd. Suite 250, 9166 Anaheim Place, Rancho  
Cucamonga, CA 91730

REPRESENTANTE CE
------------------

E-CrossStu GmbH  
Mainzer Landstr.69, 60329 Fráncfort del Meno.

REPRESENTANTE DEL REINO UNIDO
-------------------------------

YH CONSULTING LIMITADA.  
C/O YH Consulting Limited Oficina 147, Centurion  
Casa, London Road, Staines-upon-Thames, Surrey,  
TW18 4AX

**VEVOR<sup>®</sup>**  
**TOUGH TOOLS, HALF PRICE**

Soporte técnico y certificado de garantía  
electrónica [www.vevor.com/support](http://www.vevor.com/support)

