

Fisher & Paykel

Refrigerator & Freezer

**Installation instructions
and User guide**

NZ AU UK IE PAC



Active Smart™ models

635 mm wide E331T, E372B, E381T, E402B, E411T, E415H

680 mm wide E406B, E413T, E440T, E442B

790 mm wide E521T, E522B

Cyclic and Compact models

525 mm wide P120, E169T, C170T, C190, E240B, E249T, C270

635 mm wide C373, C450, E373, E450

Vertical freezer models

525 mm wide E150, E210

635 mm wide E308, E388

Chest freezer models

Slimline H215, H275, H320

Standard H160, H220, H280, H360, H510, H701

Important!

This User Guide is to be used for all refrigerator/freezers. It contains all the general information required for the operation of your refrigerator/freezer.

A User Guide is provided with the Ice & Water refrigerator. This booklet contains additional specific information about the ice and water functions on the refrigerator.

General operating instructions – all products	
Safety and warnings	2
Installation instructions	4
Moving or storing your appliance	8
Door conversion	8
Active Smart™ refrigerators	
Operating instructions	9
Special features	11
Cleaning care	13
Cyclic and Compact refrigerators	
Operating instructions	17
Special features and maintenance	18
Cleaning care	19
Vertical freezer	
Operating instructions	22
Chest freezers	
Operating instructions	23
Special features and maintenance	24
Food care – all products	
Storing food in your refrigerator	25
Storing food in your freezer	27
Problem solving checklist	29
Manufacturer's Warranty	31
Customer Care	33

Important!

SAVE THESE INSTRUCTIONS

The models shown in this User Guide may not be available in all markets and are subject to change at any time. For current details about model and specification availability in your country, please visit our local website listed on the back cover or contact your local Fisher & Paykel dealer.

2 Safety and warnings

To reduce the risk of fire, electric shock, or injury to persons read the IMPORTANT SAFETY PRECAUTIONS before operating this appliance.

Use this appliance only for its intended purpose as described in this User Guide.

Important safety precautions

Warning

When using this appliance always exercise basic safety precautions including the following:

Danger

- *This appliance is not intended for use by persons (including children) with reduced physical, sensory or mental capabilities, or lack of experience and knowledge, unless they have been given supervision or instruction concerning use of the appliance by a person responsible for their safety.*
- *Young children should be supervised to ensure they do not play with the appliance.*
- *Risk of child entrapment. Before you throw away your old refrigerator or freezer:*
 - *Take off the doors*
 - *Leave the shelves in place so that children may not easily climb inside.*
- *The manufacturer's installation instructions for product and cabinetry ventilation must be followed when installing the appliance.*
- *Keep ventilation openings, in the appliance enclosure or in the built-in structure, clear of obstruction.*
- *Do not use mechanical devices or other means to accelerate the defrosting process, other than those recommended by the manufacturer.*
- *Do not damage the refrigerant circuit.*

Disposal

- *Extreme care must be taken when disposing of your old appliance to avoid hazards. The refrigerant gas must be safely removed and for the safety of young children, remove doors.*
- *Your Fisher & Paykel Authorised Repairer will be able to give advice on environmentally friendly methods of disposing of your old refrigerator or freezer.*

Electrical

- *Your new appliance must be properly installed in accordance with the installation instructions before it is used.*
- *Never unplug your refrigerator or freezer by pulling on the power cord.*
- *Always grip the plug firmly and pull straight out from the outlet.*
- *Do not plug in any other appliance at the same power point as your refrigerator or freezer or use extension cords or double adapters.*
- *Repair or replace immediately all electric service cords that have become frayed or otherwise damaged. Do not use a cord that shows cracks or abrasion along its length or at either the plug or appliance end.*
If the power supply cord is damaged, it must only be replaced by your Fisher & Paykel Authorised Repairer because special purpose tools are required.

- *When moving your appliance away from the wall, be careful not to roll over or damage the power cord.*
- *Unplug your refrigerator or freezer before cleaning or replacing the lightbulb.*
- *Do not use electrical appliances inside the food storage compartments of the appliance, unless they are of the type recommended by the manufacturer.*

Important!

Your refrigerator is designed to operate for many years without the need for service checks. However, if your refrigerator is malfunctioning, have it attended to by your Fisher & Paykel Authorised Repairer as soon as possible. All electrical repairs must be carried out by an adequately trained service technician or qualified electrician.

Storing food and drinks

- *DO NOT store explosive substances such as aerosols cans with a flammable propellant in this appliance.*
- *Never store volatile or flammable materials in your refrigerator or freezer as they may explode.*
- *Never freeze liquids in glass containers. Liquid expands during freezing, which may cause the container to explode.*
- *Never freeze carbonated drinks. They may explode.*
- *Do not consume food if it is too cold. Food removed from the freezer compartment may be cold enough to cause damage when brought into contact with bare skin, eg frozen ice cubes.*

Power failure – food safety

- *Do not refreeze frozen foods that have thawed completely. Follow the recommendations below if you discover food in your freezer has thawed:*
 - 1) *Ice crystals still visible – food may be refrozen but should be stored for a shorter period than recommended.*
 - 2) *Thawed but refrigerator cold – refreezing generally not recommended. Fruits and some cooked food can be refrozen but use as soon as possible. Meat, fish, poultry – use immediately or cook then refreeze. Vegetables – discard as they usually go limp and soggy.*
 - 3) *Thawed but warmer than 5°C – discard all foods.*
- *Do not refreeze frozen foods that have thawed completely. The food may be dangerous to eat.*

Important!

Cleaning

- *Many commercially available cleaning products contain solvents which may attack plastic components of your refrigerator or freezer and cause them to crack. Please refer to the cleaning care section of this booklet for further advice.*

SAVE THESE INSTRUCTIONS

Installation instructions

Please follow the steps for installation to ensure your appliance operates correctly.

1. Power

- The appliance must be installed so the plug is accessible.
- To ensure that the appliance is not accidentally switched off, connect your refrigerator or freezer to its own power point. Do not plug in any other appliance at this power point or use extension cords and double adaptors, as the combined weight of both power cords can pull the double adaptor from a wall outlet socket.
- For power requirements, refer to the information on the serial plate located at the front bottom right-hand side of the refrigerator when the door is open. On chest freezers the serial plate is located on the right-hand-side at the bottom.
- It is essential that the appliance be properly grounded (earthed).

2. Location

- Your refrigerator or freezer should not be located in direct sunlight or next to any heat generating appliance such as a cooktop, oven or dishwasher.

3. Ventilation and installation

- To ensure adequate ventilation for your refrigerator or vertical freezer, see recommended cabinetry dimensions below.
- To ensure adequate ventilation for chest freezers, allow a minimum of 20 mm of airspace on each side of the cabinet, and 30 mm at the rear.
- If integrating your refrigerator, follow installation instructions provided with the integration kits.

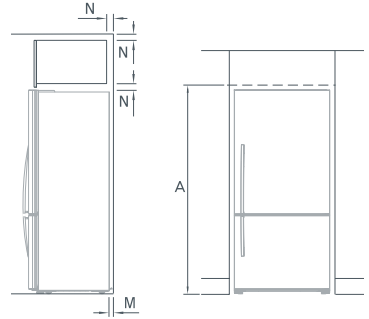

Flush with refrigerator chassis
– full door rotation

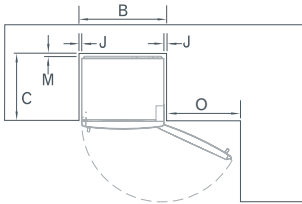

Flush with refrigerator door
– full door rotation

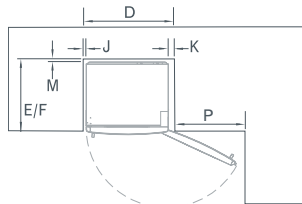

Flush with refrigerator door
– 90° door rotation

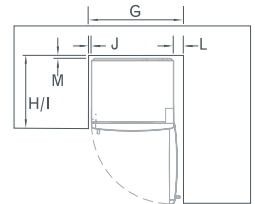

Cabinetry dimensions (mm) (including minimum clearances)	P120	C190/E150	C270/E210	C170T E169T	E240B E249T	E373/E308 C373	E450/E388 C450	E331T	E372B E415H E337B E411T E402B E413T	E406B E442B	E440T E442B	E521T E522B
A inside height	853	1255	1635	1255	1635	1475	1735	1465	1635	1735	1635	1735
Flush with refrigerator chassis – full door rotation												
B inside width	565	565	565	565	565	675	675	675	675	675	720	830
C inside depth	502	502	502	502	502	620	620	620	620	620	620	620
Flush with refrigerator door – full door rotation												
D inside width	595	595	595	595	595	705	705	705	705	705	750	860
E inside depth flush to curved door	552	552	552	552	552	670	670	675	675	675	675	675
F inside depth flush to flat door	n/a	n/a	n/a	n/a	n/a	n/a	690	n/a	n/a	690	n/a	690
Flush with refrigerator door – 90° door rotation (for full drawer/shelf access, the doors need to be open past 90°)												
G inside width	635	635	635	635	635	745	745	745	745	745	790	900
H inside depth flush to curved door	552	552	552	552	552	670	670	675	675	675	675	675
I inside depth flush to flat door	n/a	n/a	n/a	n/a	n/a	n/a	690	n/a	n/a	690	n/a	690
Minimum clearances												
J side clearance	20	20	20	20	20	20	20	20	20	20	20	20
K side clearance – hinge side flush with door – full rotation	50	50	50	50	50	50	50	50	50	50	50	50
L side clearance – hinge side flush with door – 90° rotation	90	90	90	90	90	90	90	90	90	90	90	90
M rear clearance (incl. evaporator tray)	30	30	30	30	30	30	30	30	30	30	30	30
N vent (above refrigerator cabinet or around top of cupboard)	50	50	50	50	50	50	50	50	50	50	50	50
O door clearance – hinge side flush with chassis – full rotation	425	425	425	425	425	520	520	520	520	520	555	645
P door clearance – hinge side flush door – full rotation	395	395	395	395	395	490	490	490	490	490	525	615

6 Installation instructions

4. Installation

Your Fisher & Paykel *Active Smart™* refrigerator is fitted with front and rear rollers, designed for moving the product in the forwards and backwards direction.

Avoid moving the product in a sideways direction as this may damage the rollers or the floor covering/surface.

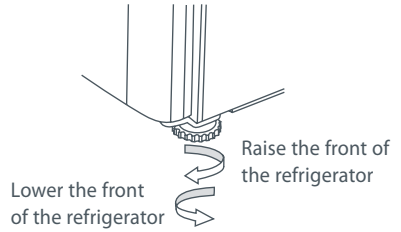

Fig.1 Refrigerator feet

- A Your refrigerator will arrive with the front feet wound up making moving the product into its final location a simple task.
- B Roll the refrigerator into its final position making sure there is the correct air gap between the product and surrounding cabinetry. See minimum clearance in cabinetry dimensions table (refer to page 5).

5. What to do if your product is unstable

- C Gently push the refrigerator back until the rear rollers contact the floor.
 - Measure the gap under the front foot, which has come off the floor.
 - Obtain some solid packing material (hardwood, plastic, etc) which fits firmly into the gap under the foot.

Note: do not use metallic materials that may corrode, stain and/or damage floor coverings.

- D Wind both front feet up and roll the product out of position.
 - Place the packing material in the location diagonally opposite the front roller that lifts off the floor.
 - Make sure the packing material stays in place when the product is pushed back into position.
 - Ideally, the packing material is large enough to rest against the back wall so as to prevent it moving when the cabinet is pushed into position.

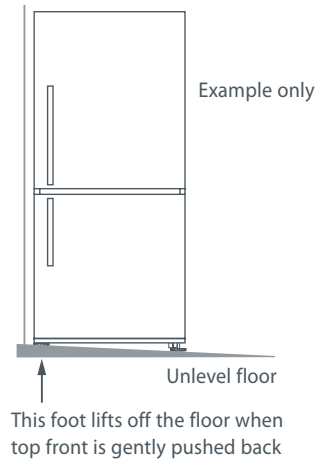
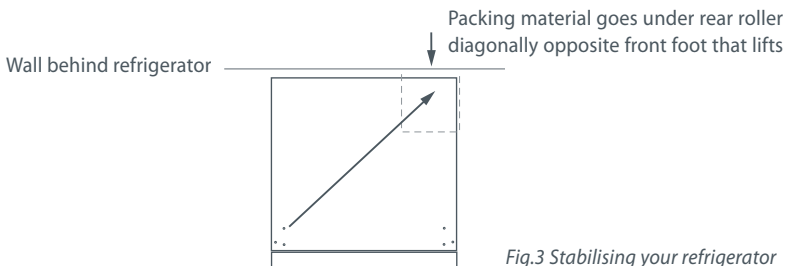

Fig.2 Unstable refrigerator



For example: if this foot lifts off the floor when pushing gently on the top front of the refrigerator

Fig.3 Stabilising your refrigerator

- E Roll the refrigerator back into position and adjust front feet as per step D. (Check alignment and door closing action are satisfactory).
- Make small adjustments to front feet where necessary.
- Check that the product is stable (all 4 feet are on the floor). If not return to step C and repeat steps D and E.

Before placing food in the fresh food or freezer compartments

- Remove all packaging. Ensure that all transit clips are removed from the refrigerator. These are small rubber stops located at the back of the shelves.
- Allow the refrigerator or freezer to run empty for 2 – 3 hours so each compartment can cool to the appropriate temperature.
- Clean the inside of the appliance with warm water and a little liquid detergent to remove manufacturing and transportation dust.
- The appliance may have an odour on its initial operation, but this will go when the refrigerator and freezer have cooled sufficiently.

Energy efficiency

For the most energy efficient use of your appliance:

- Ensure your refrigerator or freezer has adequate ventilation as recommended in the installation instructions.
- Do not cover your appliance with any material that will prevent air from flowing around the cabinet sides.
- Allow good clearances in front of air ducts within the cabinet for maximum cold air distribution.
- Cool hot foods down before placing them in the appliance.
- Do not overfill the compartment(s).
- Keep door openings to a minimum.
- Select a temperature setting that isn't too cold.
- Check your door seals for leaks.

Moving or storing your appliance

If your refrigerator or freezer is turned off for any reason, wait 10 minutes before turning it back on. This will allow the refrigeration system pressures to equalise before restarting.

Moving your appliance

- Turn off the appliance and unplug from the power point. Remove all food.
- Turn the adjustable feet to the right as far as they will turn (see page 6).
- Ease the appliance out of its position. Tuck the power cord away, if applicable tape the shelves in place and tape the doors closed. If the cabinet needs to be placed at an angle or laid down, carefully lay it on its side (the right-hand side when viewed from the front).
- Relocate and install. If the appliance has been left on its side for any length of time, leave it standing upright for at least 10 minutes before turning on.

Storing your appliance

- When storing your cleaned appliance, leave the door(s) open. This allows air to circulate and prevents the build up of bacteria and moulds.
- Before using again, clean well using a mixture of warm water and baking soda (add 1 teaspoon of baking soda to each 500 ml of water). Rinse with clean water.

Holiday time

We recommend you leave your refrigerator or freezer operating while you are on holiday.

Door conversion

If you need to hinge your door on the opposite side we recommend that you call your local Fisher & Paykel Authorised Repairer or Dealer to make this conversion.

Active Smart™ refrigerator models with silver handles need to be ordered at the point of purchase either with left or right opening doors and can not be interchanged.

All other models need to have an appropriate conversion kit for that model refrigerator. The kit is available from your Fisher & Paykel Authorised Repairer or Dealer. Full instructions are included in the conversion kit.

Models:	635 mm wide	E331T, E372B, E381T, E402B, E411T, E415H
	680 mm wide	E406B, E413T, E440T, E442B
	790 mm wide	E521T, E522B

For information on the operation of the Ice & Water control panel please refer to the Ice & Water User Guide.

Temperature control

- When the refrigerator is first turned on, the powerful cooling system will automatically cool both refrigerator and freezer compartments to their set temperatures. This will take between 2 – 3 hours.
- The two compartment temperatures are accurately and independently controlled and do not change with the temperature or humidity of the surroundings; whether summer or winter.
- If you wish to alter the temperature of either the fresh food compartment or freezer compartment, this can be easily done by using the control panel located at the back of the fresh food compartment.

Control panel to adjust temperatures

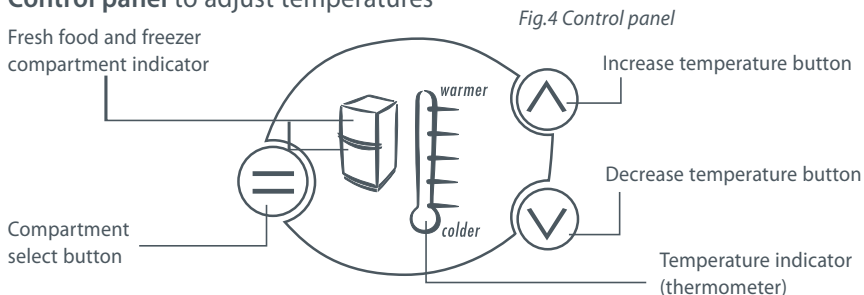

Fresh food compartment

- The fresh food compartment light on the refrigerator diagram will be showing. The temperature indicator illustrated by a thermometer will show the temperature setting for this compartment as a series of lights.
- The temperature may be altered by pressing the \wedge or \vee buttons. One press on either of these buttons will produce a dimmer light which indicates a small change in temperature.
- Pressing either button twice gives a brighter light and indicates a greater change in temperature.
- Fewer lights on the thermometer means a cooler temperature for the compartment selected.

Freezer food compartment

- To adjust the freezer temperature press the \equiv button until the light flashes on the freezer compartment indicator.
- The freezer temperature can be altered by pressing the \wedge or \vee buttons.
- One press on either of these buttons will produce a dimmer light which indicates a small change in temperature. Pressing either button twice gives a brighter light and indicates a greater change in temperature.

Note: successively pressing the \equiv button will automatically scroll between the compartments, a return to the fresh food compartment will be accompanied by a longer beep.

- When the door is re-opened the control panel will return automatically to the fresh food compartment setting.

Sabbath mode

- To activate Sabbath mode, open both the fresh food and freezer compartment doors and then hold the  button on the temperature control panel for 10 seconds.
- Both the fresh food and freezer compartment indicators will be illuminated indicating the refrigerator is in Sabbath mode.

When the product is in Sabbath mode:

- The fresh food and freezer compartment indicator lights will be illuminated.
 - The light will not operate when the door is opened.
 - The door alarm will not operate.
 - The display will not function except to indicate Sabbath mode is active as stated above.
 - Opening the door will not affect the compressor or fans.
-
- If the power to the refrigerator is turned off whilst in this mode, the product will continue in Sabbath mode when the power is restored.
 - Sabbath mode will automatically de-activate 80 hours after activation.
 - To de-activate earlier than 80 hours hold the  button on the temperature control panel for 10 seconds.

Normal refrigerator sounds

Active Smart™ refrigerators, with their excellent energy ratings and cooling performance, can produce sounds somewhat different to your old refrigerator.

Normal operational sounds include:

- Fan air flow sound. *Active Smart™* refrigerators have fans which change speed depending on demand. During cooling periods, such as after frequent door openings, fans circulate the cold air in the refrigerator and freezer compartments producing some air flow sound. This is quite normal.
- Cracking or popping which may sound like ice coming off the evaporator. This occurs when the defrost function is operating.
- Running water sound. This is the liquid refrigerant in the system and can be heard as a boiling or gurgling noise.
- An audible hissing sound after closing the freezer door. This is due to the pressure difference between the warm air that has entered the cabinet and suddenly cooled, and the outside air pressure.
- Other strange sounds may be heard for the following reasons:
 - Cabinet not level
 - Floor uneven or weak
 - Bottles or jars rattling on shelves

Fruit and vegetable bins and humidity control lid

The fruit and vegetable bins feature a unique lid which provides two functions:

- The humidity lid seals the bins to provide a humid microclimate to extend storage times of fruits and vegetables.
- The humidity lid prevents condensation, which forms at high humidities, from dripping down onto the fruit and vegetables by retaining it in the grooves of the lid.

Fruit and vegetable bins and humidity slide (where fitted)

- Each fruit and vegetable bin has a humidity control slide that can be adjusted to fruit or vegetable setting depending on what is stored in the bins.
- If possible try to store fruit and vegetables separately. This will help extend their storage life.
- If there is a mixture of fruit and vegetables in the bin adjust the position of the control to the centre.
- If there is too much water in the bins (due to the high humidity in the bins) the control can be adjusted towards the setting with fewer drips (fruit setting) and/or the water can be wiped out as required.
- Remember a small amount of water in the bins is beneficial for fruit and vegetable storage.

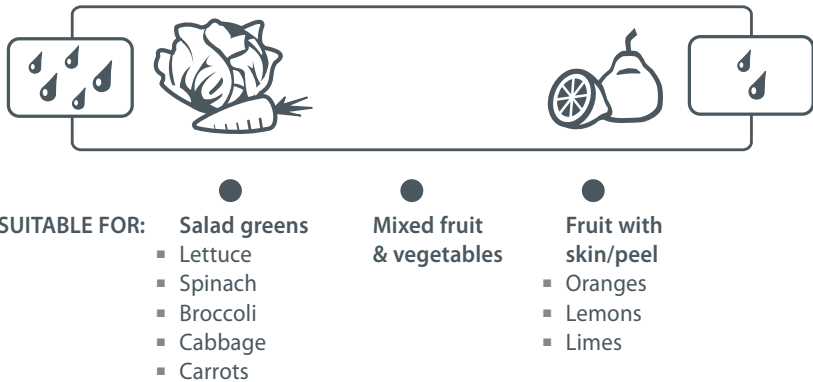

Fig.5 Humidity Control graphic

Ice trays and lid

- To empty the ice cubes into the lid, hold the tray and lid together and twist to dislodge.
- Refill the ice tray with water, place lid containing ice cubes on top and store in the freezer.
- Ice cubes are best stored in a closed container or plastic bag as they readily absorb odours and tastes from other foods.

Door alarms

- If the fresh food compartment door is left open the alarm will beep after 90 seconds and if the freezer door is left open the alarm will beep after 60 seconds.
- While either door remains open, subsequent beeps will sound every 30 seconds for 5 minutes.
- A continuous alarm will sound if the door has been left open for 5 minutes or longer and the light will turn off. The alarm will stop when the door is closed.

Fault alarms

- If the electronic controller detects a fault from which it is unable to recover an alarm will sound.
- When the fresh food compartment door is opened a fault code (specific pattern of lights) will flash red and green on the control panel to alert you to the fault. The audible alarm will stop when any button is pressed but the lights will remain flashing. If such a fault occurs, call your Fisher & Paykel Authorised Repairer immediately; the fault code will help the service person find and remedy the cause of failure.

Vegetable bin divider instructions (where fitted)

To fit the divider, insert divider into bin on an angle, straighten and slot into place. To adjust the divider, fully extend the bin, partially lift the divider, slide sideways and re-slot into position.

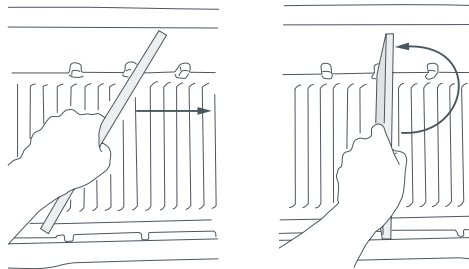

Fig.6 Vegetable bin divider

Roll out drawer (E415H model)

- The roll out drawer is suitable for storing fruits and vegetables as well as tall bottles and drinks.
- A vent/baffle is located at the front of the drawer.
- The temperature in the drawer can be adjusted by opening or closing this vent.
- Opening the vent fully allows more cold air into the drawer. Typical operating temperatures in this compartment are from 3°C to 9°C.
- The closed vent situation is ideal for storage of tomatoes, tropical fruit, cucumber, capsicum, etc. as these foods do not keep as well at colder temperatures.
- The open vent situation is suitable for most vegetables and fruits. Uncut fruit and vegetables with protective skin (eg apples and pears) can be stored without wrapping.
- To extend the storage life of other fruit and vegetables place them in loosely sealed plastic bags. This will reduce moisture loss and prevent excess moisture build-up.

Bottle holder (where fitted)

- Your refrigerator will come with 2 – 4 single bottle holders (depending on what model refrigerator you have). The bottle holders can be used to store a variety of bottles.
- To position the bottle holder in your refrigerator, simply slot the back edge of the bottle holder onto the back trim of any shelf in the fresh food compartment.
- Unused bottle racks can be stacked up on top of one another so they do not take up unnecessary shelf space.
- Bottles are best stored with the neck of the beverage facing the front of the refrigerator.

Exterior

Stainless exterior door

- It is important when cleaning the exterior door surface of your refrigerator, to only use liquid dishwashing detergent dissolved in warm water.
- Dry the door with a clean, lint free cloth.
- The use of any abrasive or stainless steel cleaners and solvents will damage the door surface.

Other exterior surfaces

- Clean all other exterior surfaces with warm water and detergent.
- If necessary, clean the magnetic door gasket with an old toothbrush, warm water and detergent.

Water evaporator tray

- The water evaporator tray is found above the compressor at the back of the refrigerator or freezer. The tray may require infrequent cleaning.
- Carefully move the refrigerator or freezer out from the wall.
- Switch off the appliance.
- We do not recommend that you remove the evaporator tray. If cleaning is required, excess water can be soaked up from the evaporator tray using a sponge. Wipe out with warm water and detergent or disinfectant.
- Switch on the appliance.

Interior

- It is important to keep the interior of the refrigerator and freezer clean to help prevent food from becoming contaminated during storage.
- The amount and types of food stored determines how often cleaning should be carried out (ideally once every 1 to 2 weeks) in the refrigerator.
- Remove the shelves from cabinet and door. Wash shelves and storage bins in warm water and detergent; rinse in clean water and dry before replacing.
- Wipe over the interior surfaces with warm water and detergent or baking soda dissolved in warm water (add 1 teaspoon of baking soda to each 500 mls of water). Rinse with clean water.
- To help remove “old stale refrigerator” smells add a few drops of vanilla essence or vinegar to the water before cleaning.
- Clean exterior surfaces with warm water and detergent. Use a toothbrush for the magnetic door gasket.
- Do not use harsh, abrasive cloths or cleaners or highly perfumed, strong smelling cleaners or solvents on any part of the refrigerator or freezer.

Important!

Many commercially available cleaning products contain solvents that may attack the plastic components of your freezer and cause them to crack. It is important to use only warm water and a small amount of liquid dishwashing detergent on any plastic components inside and outside your freezer. Avoid using anti-bacterial cleaning products on either the interior or exterior of the cabinet as they may cause rusting of metal components and cracking of plastic components.

Interior

Glass shelves

Clean with warm water and detergent or a glass cleaner. **If cleaning the shelves without removing from the cabinet, use only warm water and detergent as a glass cleaner can damage the plastic components of your refrigerator.**

Bottle holder (where fitted)

- Clean with warm water and detergent. The use of abrasive cleaners and solvents may cause damage.

To remove trays or fixed bins

- For ease of removal, empty food from tray/bin first.
- Hold the centre front of the tray/bin handle.
- Lift vertically to unclip from the runners and pull tray/bin towards you to remove.
- Push runners back into refrigerator.

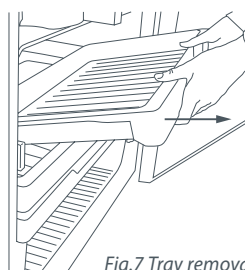
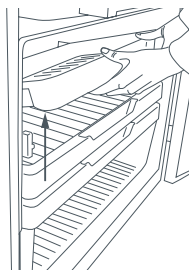

Fig.7 Tray removal

To replace trays or fixed bins:

- With the runners pushed back into the refrigerator, place the tray/bin on top of the runners. Push the tray/bin back slowly until you feel it clip back onto the runners.

Important!

Ensure that trays and bins are securely clipped onto the runners before use.

Bin and tray runners are pre-lubricated, and will not need to be re-lubricated during their life.

Do not attempt to clean grease from the runners, as this will affect their ability to function.

Do not immerse runners in water.

Humidity Control System (where fitted)

Important!

When cleaning the shelf above the vegetable bins, we recommend that you do not disassemble the Humidity Control System from the shelf.

In the event that the humidity control lid (plastic lid) and humidity slides become separated from the glass shelf, follow these instructions to reassemble.

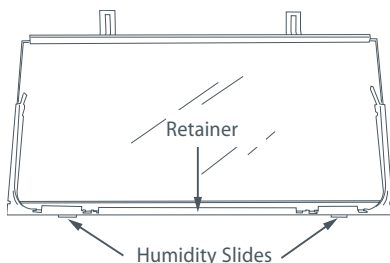

- 1 Turn shelf upside down.
- 2 To attach humidity slides onto shelf front corners, fit bottom clips into shelf front trim. Next, slide sideways towards shelf until arm clips onto glass.

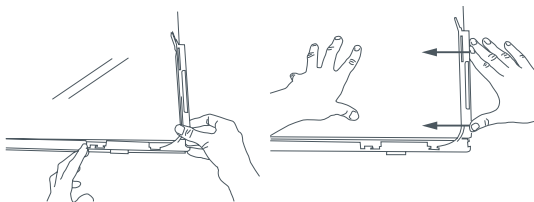

- 3 To attach humidity control lid – with text facing you, align lid with front of shelf. Hold lid vertically and fit front end into retainer on shelf. Ensure lid fits into retainer as well as underneath humidity slides.

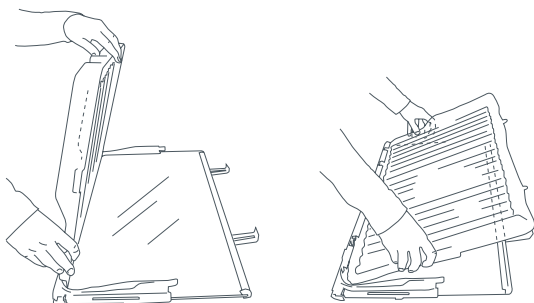

- 4 At the sides of the shelf, adjust humidity slide tabs so that the plastic lid is between the shelf and the tabs.
- 5 If clips on back of shelf are present, fasten lid with rear clips. Ensure that the cover is fully secure at front and back of shelf.

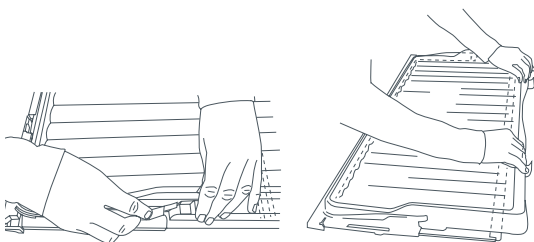

Fig.8 Humidity Control System cleaning

Roll out fruit and vegetable bin (E415H model)

- Remove for cleaning by pulling out the compartment until it stops, lifting and then continuing to slide it forward until it is fully extended.
- Rest the door front on the floor and with the refrigerator compartment door open, remove the tray, divider rack and bin. Wash with warm water and detergent.
- Rinse, dry and replace.

Lower shelf in models with roll out fruit and vegetable bin (E415H model)

- Remove the front baffle after lifting its inner edge. With the refrigerator compartment door open, slide the shelf forward and lift out. Clean with warm water and detergent.
- Rinse, dry and replace in the second groove up from the side runner rail.

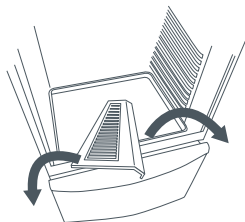

Fig.9 Front baffle

Models:	525 mm wide	P120, E169T, C170T, C190, E240B, E249T, C270 (Compact Models)
	635 mm wide	C373, E373, C450, E450

Temperature control

- The control has been factory set for normal operating conditions.
- Allow the refrigerator to run empty for 2 – 3 hours before placing food inside the fresh food or freezer compartments.
- Re-adjust the control as necessary to suit your individual preference.

1 is warmest setting

7 is coldest setting

- We recommend adjusting the temperature by half a setting initially and then allow at least 24 hours for the cabinet temperature to stabilise before re-adjusting.
- If you are altering the temperature of a 2-door refrigerator, remember you are altering the temperature of both compartments.
- The running time and temperature are affected by where your refrigerator is located, how often the door is opened and the temperature of the room the refrigerator is located in. Your refrigerator is designed to operate in a room temperature of between 10°C and 43°C.

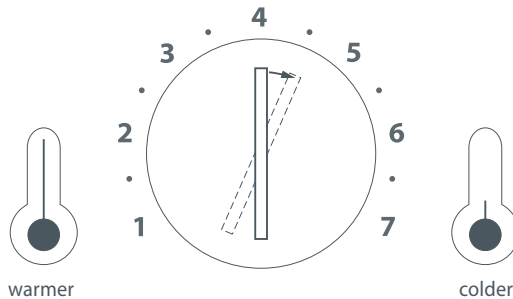

Fig.10 Temperature knob

P120 Ice box

This is designed for short-term storage of frozen foods and ice only. It is recommended that the tray is kept in place under the ice box at all times.

Door alarms (E169T, E240B, E249T, E373, E450 models only)

- If the fresh food compartment door is left open the alarm will beep after 90 seconds.
- If the door remains open, subsequent beeps will sound every 30 seconds for 5 minutes.
- A continuous alarm will sound if the door has been left open for 5 minutes or longer.
- The alarm will stop when the door is closed.

Fault alarms

- If the electronic controller detects a fault from which it is unable to recover, an alarm will sound when the door is opened.
- When the fresh food compartment door is opened and a fault has occurred, a specific number of beeps will sound. If a fault occurs, call your Fisher & Paykel Authorised Repairer immediately; the number of beeps will help the service person find and remedy the cause of failure.

Humidity control lid (635 mm wide models)

The fruit and vegetable bins feature a unique lid which provides two functions:

- The humidity control lid seals the bins to provide a humid microclimate to extend storage times of fruits and vegetables.
- The humidity control lid prevents condensation, which forms at high humidities, from dripping down onto the fruit and vegetables by retaining it in the grooves of the lid.

The ability to retain high humidity in the fruit and vegetable bin may produce small amounts of water in the bottom of the fruit and vegetable bin. This can be wiped out as required.

Replacement of interior light

- Turn the power off at the wall before replacing the lamp. The interior lamp is located at the back of the temperature control box and is removed by unscrewing it.
- Replace bulb, making sure it is tightly screwed in. Switch power back on again.
- The replacement bulb must not exceed 15 Watts. Bulbs are available from your Fisher & Paykel Authorised Repairer.

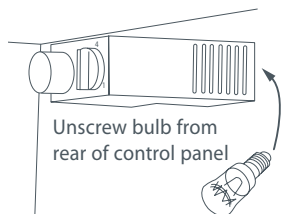

Fig.11 Temperature control box

Important!

Your refrigerator is designed to operate for many years without the need for frequent service checks. However, if your refrigerator is malfunctioning, have it attended to by your Fisher & Paykel Authorised Repairer as soon as possible. All electrical repairs must be carried out by an adequately trained service technician or qualified electrician.

Exterior

Stainless exterior door

- It is important when cleaning the exterior door surface of your refrigerator, to only use liquid dishwashing detergent dissolved in warm water.
- Dry the door with a clean, lint free cloth.
- The use of any abrasive or stainless steel cleaners and solvents will damage the door surface.

Other exterior surfaces

- Clean all other exterior surfaces with warm water and detergent.
- If necessary, clean the magnetic door gasket with an old toothbrush, warm water and detergent.

Water evaporator tray

- The water evaporator tray is found above the compressor at the back of the refrigerator or freezer. The tray may require infrequent cleaning.
- Carefully move the refrigerator or freezer out from the wall. Switch off the appliance.
- We do not recommend that you remove the evaporator tray. If cleaning is required, excess water can be soaked up from the evaporator tray using a sponge. Wipe out with warm water and detergent or disinfectant.
- Switch on the appliance.

Interior

- It is important to keep the interior of the refrigerator and freezer clean to help prevent food from becoming contaminated during storage.
- The amount and types of food stored determines how often cleaning should be carried out (ideally once every 1 to 2 weeks) in the refrigerator.
- Remove the shelves from cabinet and door. Wash shelves and storage bins in warm water and detergent; rinse in clean water and dry before replacing.
- Wipe over the interior surfaces with warm water and detergent or baking soda dissolved in warm water (add 1 teaspoon of baking soda to each 500 mls of water). Rinse with clean water.
- To help remove "old stale refrigerator" smells add a few drops of vanilla essence or vinegar to the water before cleaning.
- Clean exterior surfaces with warm water and detergent. Use a toothbrush for the magnetic door gasket.
- Do not use harsh, abrasive cloths or cleaners or highly perfumed, strong smelling cleaners or solvents on any part of the refrigerator or freezer.

Glass shelves

- Clean with warm water and detergent or a glass cleaner. **If cleaning the shelves without removing from the cabinet use only warm water and detergent as a glass cleaner can damage the plastic components of your refrigerator.**

Vegetable bin (525 mm wide models – except P120 models)

- Wash in warm water and detergent. Rinse and dry.

Fruit and vegetable bins and lid (635 mm wide models)

- Remove bins then the bottom refrigerator shelf.
- Place the shelf upside down on a flat surface. Pull lid at position **A** then lift up at position **B**. Take lid off at sides. Clean lid and bins in warm soapy water.
- To reassemble, insert lid and clip at position **C**, then snap in the clip at position **A**.

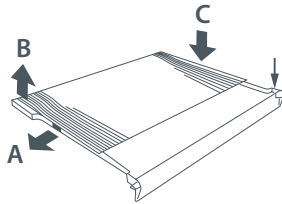

Fig.12 Humidity Control lid

Defrosting the freezer model C170T

- It is recommended that a freezer be defrosted when the frost is greater than 6 mm thick.
- Remove all frozen food and wrap it in several layers of paper. Place food in the refrigerator compartment or a cool environment, eg insulated picnic bin.
- Switch the power off at the wall. The temperature control can remain at its normal setting.
- Remove the freezer baskets or shelves for ease of cleaning.
- Whilst defrosting, leave the freezer door open. If you wish to reduce the defrosting time place a bowl of warm water in the freezer compartment and leave the door open. Keep the refrigerator compartment door closed.
- Use the scraper supplied or a plastic spatula to remove any loose ice. Do not use knives or any other sharp instrument to remove the ice, otherwise the freezer surface may become permanently damaged.
- Ensure that the defrosting of your freezer is carried out as quickly as possible. During defrosting a rise in temperature of frozen food above normal storage temperature can shorten the storage life of the food.
- Wipe the freezer dry. Replace the frozen food.
- Switch the refrigerator on.

Defrosting models with ice boxes

The P120 is designed for short-term storage of frozen foods and ice only.

- Remove all frozen food and wrap it in several layers of paper. Place in a cool environment, eg insulated picnic bin.
- Position the tray provided beneath the ice box to collect the melting ice.
- Push the defrost button in the centre of the control knob and the compressor will stop. The defrost time may be reduced by placing a bowl of warm water in the ice box and leaving the door of the refrigerator open. Once it has reached the defrost temperature, the compressor will start operating again.
- Use the scraper supplied or a plastic spatula to remove any loose ice.
- Immediately after the refrigerator has automatically restarted, empty the tray of water and ice.
- Wipe the tray and ice box dry.
- Replace the frozen food.

22 Vertical freezer operating instructions

Models:	525 mm wide	E150, E210
	635 mm wide	E308, E388

Temperature control

- The cabinet control is located at the bottom rear of the cabinet.
- The control has been factory set to position 4 for normal operating conditions.
- The freezer temperature should be approximately -18°C .
- Re-adjust the control as necessary to suit your individual preference.

1 is the warmest setting.
7 is the coldest setting.

Door alarms

- If the door is left open the alarm will beep after 60 seconds.
- If the door remains open, subsequent beeps will sound every 30 seconds for 5 minutes.
- A continuous alarm will sound if the door has been left open for 5 minutes or longer.
- The alarm will stop when the door is closed.

Fault alarms

- If the electronic controller detects a fault from which it is unable to recover, an alarm will sound when the door is opened.
- When the door is opened and a fault has occurred, a specific number of beeps will sound. If a fault occurs, call your Fisher & Paykel Authorised Repairer immediately; the number of beeps will help the service person find and remedy the cause of failure.

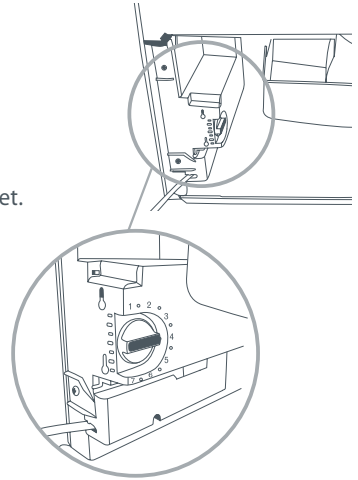

Fig.13 Control box

Temperature control

- The temperature of the freezer is controlled by a thermostat fitted near the right-hand rear corner of the freezer.
- The thermostat has been set to position 4 at manufacturing for normal operating conditions and should not need adjustment.
- The freezer compartment should be approximately -18°C . At this temperature the food will keep for the length specified on the freezer storage guide.
- Re-adjust the control as necessary to suit your individual preference.

1 is the warmest setting.

7 is the coldest setting.

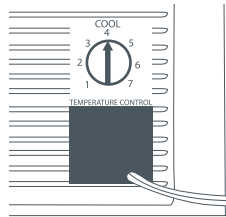

Fig.14 Temperature control

Defrosting your chest freezer

- It is recommended that your freezer be defrosted when the frost is greater than 6 mm thick using the plastic scraper provided.
- Remove all frozen food and wrap it in several layers of paper. Place in a refrigerator compartment or a cool environment, eg insulated bin.
- Switch the power off at the wall.
- Unplug and open the defrost water drain and spout. Place a shallow container under the spout. Pour approximately 1 litre of warm water down the drain to clear it of possible residual ice. Should it remain blocked, the spout can be removed to aid thorough cleaning.
- While defrosting, leave the freezer lid open. If you wish to reduce the defrosting time, place containers of hot water in the freezer and close the lid. Use the scraper supplied and a plastic spatula to remove any loose ice.
- Empty out the tray of water. Wipe out the defrosted freezer. Use a mix of 500 ml water with 1 teaspoon of baking soda or a small amount of liquid dishwashing detergent and warm water. Rinse with clean water and dry.
- Carefully clean the drain and spout. Replace the drain plug and then close the spout.
- Switch the freezer on. Close the lid and leave running for 15 minutes before replacing the frozen food.
- Do not use knives or any other sharp instrument to remove the ice as the freezer surface may become irreversibly damaged.
- Also do not use harsh abrasive cloths and cleaners, or highly perfumed strong smelling cleaners or solvents on either the interior or exterior of the freezer.
- Frost forms faster on the top edge of the freezer compartment in climates of high humidity as this is the area of first contact to the warm moist air when the lid is open.
- Your chest freezer is designed with a flexible lid seal to keep warm air out of the freezer. Sometimes immediately after closing your chest freezer, you may notice the lid is difficult to re-open. This is normal. Wait a few minutes and try again.

Freezer baskets

- The baskets supplied with your freezer are removable.
- They may be stacked on top of each other by folding the handles downwards. Ensure that packages do not protrude above the top of each basket, and for ease of lifting make sure they are not loaded with a lot of heavy food.
- We recommend that foods requiring longer storage should be kept at the bottom of the freezer.

Replacement of interior light

- When it is necessary to replace the light bulb, turn the freezer off at the wall, remove the light cover and unscrew the bulb. Replace with a new bulb, noting that it must not exceed 15 Watts.

Important!

Your refrigerator is designed to operate for many years without the need for frequent service checks. However, if your refrigerator is malfunctioning, have it attended to by your Fisher & Paykel Authorised Repairer as soon as possible.

All electrical repairs must be carried out by an adequately trained service technician or qualified electrician.

Storing fresh, perishable foods in your refrigerator helps to extend storage times. The cold temperatures slow down the major causes of food spoilage – namely, the growth of bacteria, moulds and yeasts, and chemical and physical reactions.

Fresh food care

The quality of food before it is placed in the refrigerator is critical to successful storage. For best results:

- Select foods that are very fresh and of good quality.
- Buy only the amount that you will use within the recommended storage time. If you buy extra, plan to freeze it.
- Ensure that food is well wrapped or covered before it is stored. This will prevent food from dehydrating, deteriorating in colour or losing taste and will help maintain freshness. It will also prevent odour transfer. Vegetables and fruit need not be wrapped provided they are stored in the vegetable bins of the refrigerator.
- Make sure that strong smelling foods are wrapped or covered and stored away from foods such as butter, milk and cream which can be tainted by strong odours.
- Refrigerate fresh, perishable foods as soon as possible after purchase. If left at room temperature for any length of time the rate of deterioration will be accelerated.
- Avoid placing food directly in front of air outlets, as it may freeze. Cold air needs to circulate to maintain safe food storage. Do not open the refrigerator door unnecessarily.
- Cool hot foods down before placing them in the refrigerator. This should be done quickly. It can be aided by placing the container of food in a bowl of ice and water; renew the ice as necessary. (Note also that hot containers may damage shelves and wall of the refrigerator).
- Store raw and cooked food in separate containers or packaging to prevent cross contamination.

In addition:

- Keep the refrigerator clean. Wipe the inside walls and shelves frequently (refer to Cleaning Care) and place only clean containers in the refrigerator.
- Keep a close check on the quality of food in your refrigerator. Discard any food that shows signs of spoilage. Pay particular attention to meat, fish and poultry, as these foods are highly perishable. Use food within the recommended storage times.

Dairy foods and eggs

- Most pre-packed dairy foods have a recommended 'use by/best before/best by' date stamped on them. Store them in the refrigerator and use within the recommended time.
- Butter can become tainted by strong smelling foods so it is best stored in a sealed container.
- Eggs should be stored in the refrigerator. For best results, especially when baking, remove the eggs from the refrigerator two hours before they are to be used.

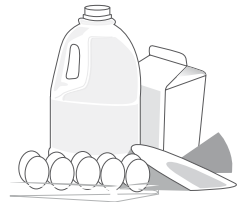

26 Storing food in your refrigerator

Red meat

- Place fresh red meat on a plate and loosely cover with waxed paper, plastic wrap or foil.
- Store cooked and raw meat on separate plates. This will prevent any juices lost from the raw meat from contaminating the cooked product.
- Delicatessen meats should be used within the recommended storage time.



Poultry

- Fresh whole birds should be rinsed inside and out with cold running water. Dry and place on a plate. Cover loosely with plastic wrap or foil.
- Poultry pieces should also be stored this way. Whole poultry should never be stuffed until just before cooking, otherwise food poisoning may result.
- Cool and refrigerate cooked poultry quickly. Remove stuffing from poultry and store separately.



Fish and seafood

- Whole fish and fillets should be used on the day of purchase. Until required, refrigerate on a plate loosely covered with plastic wrap, waxed paper or foil.
- If storing overnight or longer, take particular care to select very fresh fish. Whole fish should be rinsed in cold water to remove loose scales and dirt and then patted dry with paper towels. Place whole fish or fillets in a sealed plastic bag.
- Keep shellfish chilled at all times. Use within 1 – 2 days.

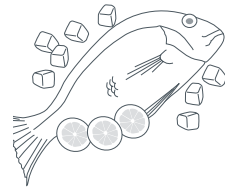

Precooked foods and leftovers

- These should be stored in suitable covered containers so that the food will not dry out.
- Keep for only 1 – 2 days.
- Reheat leftovers only once and until steaming hot.

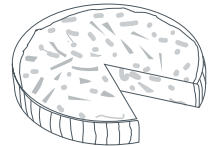

Fruit and vegetable bins

- Although most fruit and vegetable varieties store best at low temperatures, take care not to store the following at temperatures of less than 7°C for long periods: Citrus fruit, melons, eggplant, pineapple, paw paw, courgettes, passionfruit, cucumber, peppers, tomatoes.
- Undesirable changes will occur at low temperatures such as softening of the flesh, browning and/or accelerated decaying.
- Do not refrigerate avocados (until they are ripe), bananas, mangoes or pepinos. If possible store fruit and vegetables separately, ie fruit in one bin and vegetables in the other.

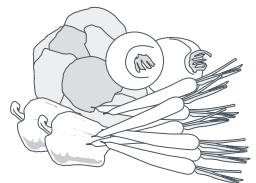

The use of temperatures of -18°C or colder to store food means that the food can be kept for longer periods than when refrigeration temperatures are used. This is because the growth of bacteria, moulds and yeasts are stopped, and chemical and physical reactions are severely restricted at very low temperatures.

Frozen food care

For best results:

- Choose only high quality foods that freeze well.
- Store at -18°C or colder. Take care to maintain this low storage temperature, eg try to avoid opening the freezer door unnecessarily. If your ice cream is soft you are running your freezer too warm.
- Leave space at the top of containers, glass jars or plastic bags containing liquids or semi-solid foods as they expand during freezing. Usually 20 – 50 mm head space is recommended. Seal. Ideally, remove all the air from the package after food is frozen.
- Packages or containers of solid foods should have the air removed from them and be sealed tightly before freezing.
- Freeze immediately and as quickly as possible. Freeze only small quantities of food at any one time. For best results we recommend that only 1 kg of food be frozen per 25 L freezer capacity. (About 3 kg in small freezers and 4 kg in larger freezers). For faster freezing in *Active Smart™* models, we recommend that fresh food is placed at the top of the freezer compartment close to the air vent.
- Do not pile frozen food around the fan cover. It can prevent adequate air circulation.
- Thaw foods preferably in a refrigerator, or using a microwave oven or multifunction oven.
- Keep a constant turnover of food. Use older items of food first. Do not exceed recommended storage times.
- Use good quality freezer proof packaging to maintain food quality.
- If food is only covered in plastic film place inside a freezer-proof plastic bag.

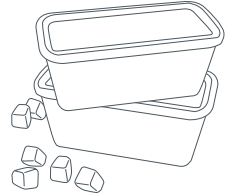

Recommended freezer storage times

These times should not be exceeded.

	M o n t h s	1	Bacon, casseroles, milk
		2	Bread, ice cream, sausages, pies – (meat and fruit), prepared shellfish, oily fish
		3	Non-oily fish, shellfish, pizza, scones and muffins
		4	Ham, cakes, biscuits, beef and lamb chops, poultry pieces
		6	Butter, vegetables (blanched), eggs whole and yolks, cooked crayfish, minced meat (raw), pork (raw)
		12	Fruit (dry or in syrup), egg whites, beef (raw), whole chicken, lamb (raw), fruit cakes

Meat, poultry and game

- Do not try to freeze more than 1 kg meat per 25 L freezer capacity. Meat must be frozen quickly in order to maintain its texture.
- Do not stuff poultry before freezing.
- Red meat can be cooked from frozen, or from the partly or completely thawed states. Remember to allow extra cooking time if cooking from frozen.
- Always thaw poultry completely before cooking.



Fish

- Fish is best frozen commercially. If, however, you do want to freeze fish at home, make sure the fish is very fresh and of high quality.
- Clean, scale and preferably leave whole. All fish should be wrapped in two layers of packaging as depending on the type of fish, odours and flavours can be readily transferred either to or from it. Seal well.
- For best results, cook from either the frozen or partly thawed state.

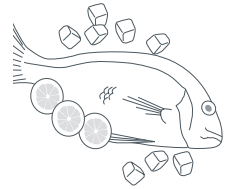

Vegetables

- Most vegetables freeze well, although 'salad' vegetables lose their crispness. Other vegetables, eg celery, onion and tomatoes, should only be used in cooked dishes as they soften on freezing.
- Freeze only high quality, mature, ready-to-eat vegetables.
- Sort and discard any that are damaged.
- It is necessary to blanch most raw vegetables prior to freezing.**
- Blanching involves a short cooking period during which vegetable enzymes are destroyed. If these enzymes are not destroyed they cause undesirable physical and chemical changes during freezer storage.
- Vegetables can be blanched in boiling water, steam or in a microwave oven. If using boiling water, boil vegetables for 2 – 4 minutes and cool quickly.
- In general frozen vegetables are best cooked from their frozen state.

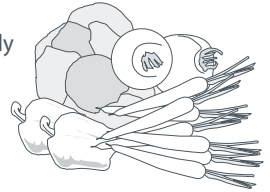

Prepared and cooked foods

- Most cooked foods can be frozen but it is not recommended to freeze the following:

Cooked egg white, custards, cream fillings and milk puddings, gelatine or jelly-like dishes, mayonnaise and similar salad dressings, meringue toppings. These tend to separate on thawing.

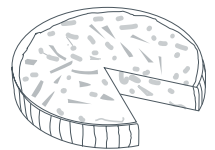

Fruit

- Choose high quality, mature, and ready-to-eat fruit. Preferably select varieties recommended for freezing.
- Avoid unripe and over-ripe fruit.
- The way fruit is packed depends on how it is to be used. Fruits packed in syrup are ideal for desserts, whereas fruits packed without sugar are better used for cooking. Most fruits can be stored for 8 – 12 months.



If there is a problem with your appliance, please check the following points before contacting your local Fisher & Paykel Authorised Repairer or Customer Care Centre.

Problem	Possible causes	What to do
Appliance does not operate.	No electricity at power outlet.	<p>Check that the plug is correctly connected and power switched on.</p> <p>Check another appliance at the same outlet.</p> <p>Check house fuse.</p>
Light not working.	Light not functioning.	<p>Check the inside front cover of this booklet and your refrigerator's serial plate (located at the bottom right corner of the product) to determine what model refrigerator you have:</p> <ul style="list-style-type: none"> ▪ For Active Smart™ models – the light cannot be serviced by the user. Contact your Fisher & Paykel Dealer or Authorised Repairer. ▪ For Cyclic and Compact, Vertical freezer and Chest freezer models – the light bulb has blown, replace bulb.
	Refrigerator not working	<p>Check refrigerator is turned on at wall.</p> <p>If problem continues refer to page 33.</p>
Light and display not working.	Product in Sabbath Mode	Hold the  button down for 10 seconds.
Motor operates for long periods.	Hot weather. Frequent door or lid openings. Large amount of food recently added.	Minimise door or lid openings to allow temperatures to stabilise.
	Temperature control set too low.	See Temperature control section.
	Doors not sealing properly.	Check that cabinet is level and gasket seals are clean.
Storage compartment(s) too warm.	Temperature setting not correct.	See Temperature control section.
	Frequent door or lid openings. Large amount of food recently added.	Minimise door or lid openings to allow temperatures to stabilise.
Food freezing in the refrigerator.	Temperature setting not correct.	See Temperature control section.
	Food placed directly in front of air outlets.	Move chill sensitive foods away from the centre back of the shelf.
Unfamiliar noises.	Cabinet not stable or level	See Installation section.
	Freezer is defrosting.	

30 Problem solving checklist

Problem	Possible causes	What to do
Condensation/ water in the vegetable bins.	Fruit and vegetables continue to respire after harvest, giving off water which can form as condensation in the bins.	A small amount of condensation is beneficial for fruit and vegetable storage. If there is too much water, store fruit and vegetables loosely wrapped in plastic bags. Wipe out water with a cloth. Set humidity slide to low humidity setting 
Condensation inside fresh food compartment.	Frequent or long door openings.	Minimise door openings.
	Door gasket leaking.	Check that gasket is sitting flat and sealing tightly.
	Not unusual during periods of high humidity.	Wipe dry.
Ice buildup inside freezer compartment.	Freezer door not closing tightly.	Move items in freezer so door can close tightly. Check and clean door gasket seal.
	In chest freezer over a period of time, ice will build up, this is normal.	Defrost chest freezers if ice build up is more than 6 mm deep.
Taste or odour in ice cubes.	Transfer of odour/taste from strong smelling foods.	Wrap or cover strong smelling foods.
Door handles out of alignment.	With time and usage, movement may occur .	See Installation instructions – Stability instructions.
Door alarm not working – E240B, E249T, E169T only.	Refrigerator compartment light not working.	Replace bulb – refer to page 18.
Tray/bin does not slide in and out evenly.	Packaging trapped.	Check to ensure no food or packaging is trapped behind the tray/bin.
	Runners not extending fully.	Holding onto sides of tray/bin, extend the runners fully by using a firm pull – this will reset the runner.

You automatically receive a 2 year Manufacturer's Warranty with the purchase of this Product covering parts and labour for servicing within the country of purchase.

Fisher & Paykel undertakes to:

Repair or, at its option, replace without cost to the owner either for material or labour any part of the Product, the serial number of which appears on the Product, which is found to be defective within TWO YEARS of the date of purchase.

Note

This Warranty is an extra benefit and does not affect your legal rights.

This Warranty DOES NOT cover

A Service calls which are not related to any defect in the Product. The cost of a service call will be charged if the problem is not found to be a Product fault. For example:

1. Correcting the installation of the Product.
2. Instructing you how to use the Product.
3. Replacing house fuses or correcting house wiring or plumbing.
4. Correcting fault(s) caused by the user.
5. Noise or vibration that is considered normal, eg drain/fan sounds, refrigeration noises or user warning beeps.
6. Correcting damage caused by pests, eg rats, cockroaches, etc.
7. Replacement light bulbs.

B Defects caused by factors other than:

1. Normal domestic use or
2. Use in accordance with the Product's User Guide.

C Defects to the Product caused by accident, neglect, misuse or Act of God.

D The cost of repairs carried out by non-authorized repairers or the cost of correcting such unauthorised repairs.

E Normal recommended maintenance as set out in the Product's User Guide.

F Repairs when the appliance has been dismantled, repaired or serviced by other than a Fisher & Paykel Authorised Repairer or the selling dealer.

G Pick-up and delivery.

H Transportation or travelling costs involved in the repair when the Product is installed outside the Fisher & Paykel Authorised Repairer's normal service area.

This Product has been designed for use in a normal domestic (residential) environment. This Product is not designed for commercial use (whatsoever). Any commercial use by a Customer will affect this Product's Warranty.

Service under this Manufacturer's Warranty must be provided by a Fisher & Paykel Authorised Repairer (refer to the 'Customer care' section at the back of this book). Such service shall be provided during normal business hours. This Warranty certificate should be shown when making any claim.

For Australian Customers

This Warranty is an extra benefit and does not affect your legal rights. Our goods come with guarantees that cannot be excluded under the Australian Consumer Law. You are entitled to a replacement or refund for a major failure and for compensation for any other reasonably foreseeable loss or damage. You are also entitled to have the goods repaired or replaced if the goods fail to be of acceptable quality and the failure does not amount to a major failure.

Please keep this User Guide in a safe place.

Before you call for service or assistance...

Check the things you can do yourself.
Refer to your User Guide and check:

- 1 Your appliance is correctly installed.
- 2 You are familiar with its normal operation.
- 3 You have read the problem solving at the back of the book.

If after checking these points you still need assistance, please refer to your nearest Fisher & Paykel Authorised Repairer, or contact us through our local website listed on the back cover.

In New Zealand if you need assistance...*

Call your Fisher & Paykel retailer who is trained to provide information on your appliance, or if we can be of any further help, please contact our Customer Care Centre.

Toll Free: 0800 FP CARE or 0800 37 2273

Fax: (09) 273 0656

Email: customer.care@fp.co.nz

Postal address: Fisher & Paykel Appliances Ltd, PO Box 58732, Botany, Manukau 2163, Auckland.

If you need service...*

Fisher & Paykel has a network of independent Fisher & Paykel Authorised Repairers whose fully trained technicians can carry out any service necessary on your appliance. Your dealer or our Customer Care Centre can recommend a Fisher & Paykel Authorised Repairer in your area.

In Australia if you need assistance...*

Please call our Fisher & Paykel Customer Care Centre.

Toll Free: 1 300 650 590

Fax: (07) 3826 9298

Email: customer.care@fp.com.au

Postal Address: P.O. Box 798, Cleveland, QLD4163

If you need service...*

Fisher & Paykel has a network of qualified Fisher & Paykel Authorised Repairers responsible for servicing only Fisher & Paykel branded appliances. Our Customer Care Centre can recommend a qualified Fisher & Paykel Authorised Repairer in your area.

In United Kingdom if you need assistance...*

Phone: (0845) 066 2200

Fax: (0845) 331 2360

Email: customer.care@fisherpaykel.co.uk

Postal address: Fisher & Paykel Appliances Ltd, Maidstone Road, Kingston, Milton Keynes, Buckinghamshire, MK10 0BD



In Ireland if you need assistance...***Phone:** 1800 625 174 or 01-8077960**Fax:** 1800 635 012**Email:** customer.care@fisherpaykel.ie**Postal address:** Fisher & Paykel Appliances, Unit D2, North Dublin Corporate Park, Swords, Co. Dublin**For the rest of the world...***

Call your Fisher & Paykel Retailer/Dealer from whom you purchased the product. They are trained to provide information on your appliance. If we can be of any further help, please contact us on:

Phone: +64 9 273 0660**Fax:** +64 9 273 0580**Email:** international.enquiries@fp.co.nz**Postal address:** Fisher & Paykel Appliances Ltd, PO Box 58732, Botany, Manukau 2163, Auckland, New Zealand**Feel free to contact us at our website on**www.fisherpaykel.co.nzwww.fisherpaykel.com.auwww.fisherpaykel.co.ukwww.fisherpaykel.ie

*If you call, write or contact our website please provide: your name and address, model number, serial number, date of purchase and a complete description of the problem. This information is needed in order to better respond to your request for assistance.

Product details

Fisher & Paykel Appliances Ltd

Model/Serial No.**Date of Purchase** _____ **Purchaser** _____**Dealer** _____ **Suburb** _____**Town** _____ **Country** _____

www.fisherpaykel.co.nz
www.fisherpaykel.com.au
www.fisherpaykel.co.uk
www.fisherpaykel.ie

Fisher & Paykel

Copyright © Fisher & Paykel 2011. All rights reserved.

The product specifications in this booklet apply to the specific products and models described at the date of issue. Under our policy of continuous product improvement, these specifications may change at any time. You should therefore check with your Dealer to ensure this booklet correctly describes the product currently available.