

ZOSI
PROFESSIONAL SECURITY MADE EASY

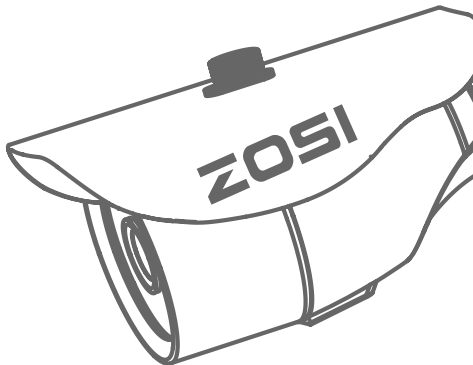

Security Camera

Day/Night

EN V1.1

INSTRUCTION MANUAL

Introduction

Congratulations on your purchase of This CCTV camera from ZOSI. This camera can operate in almost all lighting conditions, from bright daylight (provided it's not pointed straight toward the sun) to pitch darkness.

The camera is very sensitive to light and therefore can make use of even the smallest amount of light to provide an image of what it sees. In low light, this comes through as a black and white image.

In complete or near-total darkness, the camera uses built-in infrared LEDs to illuminate the area in front of it. This light is invisible to the human eye, although you might notice a faint red glow coming from the front of the camera this is normal.

In day or well-lit environments, the IR Cut Filter feature of the camera activates to filter out wavelengths of light the camera does not need in order to provide a clear color image.

Important note: All jurisdictions have specific

laws and regulations relating to the use of cameras. Before using any camera for any purpose, it is the buyer's responsibility to be aware of all applicable laws and regulations that prohibit or limit the use of cameras and to comply with the applicable laws and regulations.

Warning: Modifications not approved by the party responsible for compliance could void user's authority to operate the equipment.

Important safety instructions

- 1) Make sure product is fixed correctly and stable if fastened in place.
- 2) Do not operate if wires and terminals are exposed.

Choosing a Location for this Camera

To get optimal results from your camera, where you install is important. You should consider the distance between the camera and its subject to ensure you obtain a good view of the areas in focus. Also think about the appropriate mounting places (e.g., under the eaves of a roof is a good choice) where it won't be either an easy target for vandals or affected by constant light reflections of moving vehicles (which can result in falsely triggered motion detection). There are a number of factors you will need to consider when choosing where to mount your camera - not least of which is what you will want to see.

To mount the camera

Position the camera in the location you want to mount it, and mark the screw holes on the surface to position the screws. Then, using appropriate screws for the surface you're fixing the camera to, screw the camera into place.

If you're mounting to a wooden surface, then screw the camera directly to the surface.

If you're mounting to a masonry surface (bricks, concrete or similar) then you'll need to use the included wall plugs.

Mounting the Camera

The camera can be mounted onto a flat, vertical surface using screws. The surface must have sufficient strength to hold the camera. Materials such as hardwood, brick or masonry are good options, You can mount the camera onto a metal surface, but you'll need to supply your own mounting hardware.

Positioning the Cables

1. When running your cable, try to avoid bending it at sharp angles.
2. Don't put your cable near live electrical wiring. AC electricity generates radio "noise" which can interfere with the signal from your camera.
3. All wiring and connectors must be suitably insulated and protected from moisture and sunlight because they are not weather resistant.

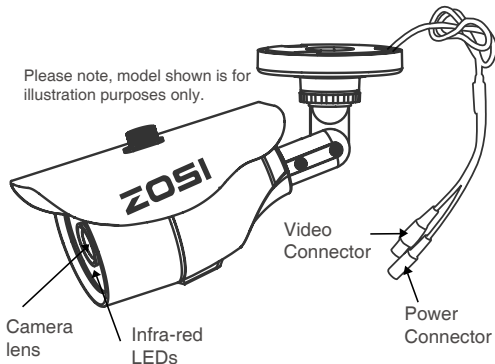

Mounting the Camera

Model 1

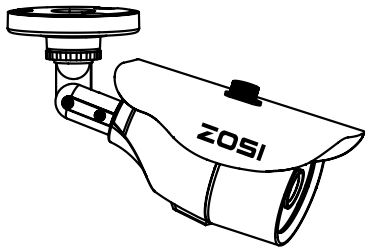
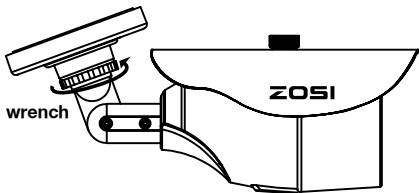
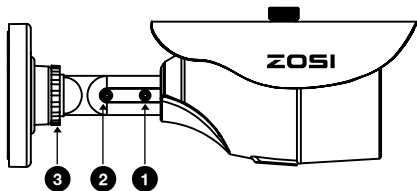

- 1 Rotate the camera by loosening the screw (using screw driver).
- 2 Adjust the elbow joint by loosening the screw.
- 3 The neck of the stand attached to the mounting base, rotate the stand by loosening the radial joint locking ring. Once in position, tighten the ring again.

Mounting the Camera

Model 2

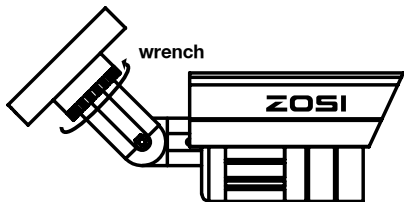
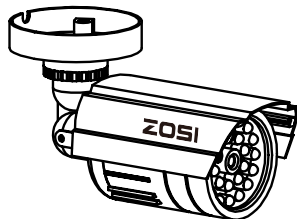
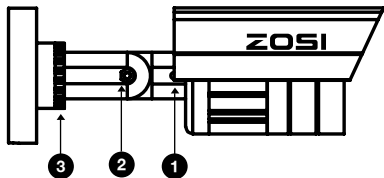

- 1 Rotate the camera by loosening the screw (using screw driver).
- 2 Adjust the elbow joint by loosening the screw.
- 3 The neck of the stand attached to the mounting base, rotate the stand by loosening the radial joint locking ring. Once in position, tighten the ring again.

Mounting the Camera

Model 3

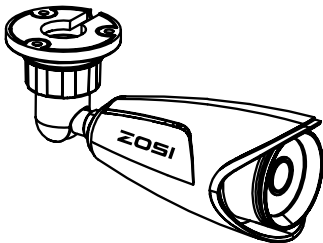
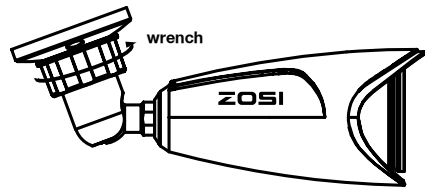
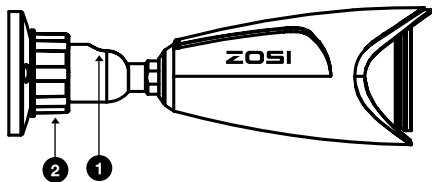

- 1 Adjust to the position you want up or down.
- 2 The neck of the stand attached to the mounting base, rotate the stand by loosening the radial joint locking ring. Once in position , tighten the ring again.

Mounting the Camera

Model 4

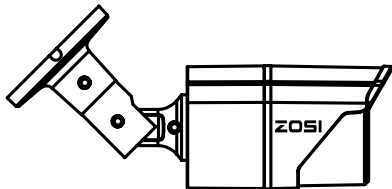
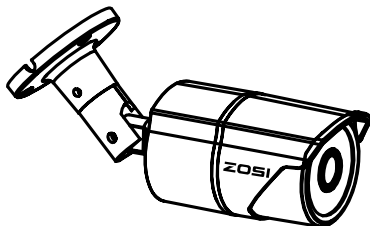
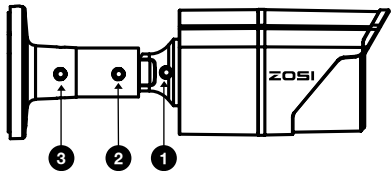

- 1 loosen the screw on each side to adjust this joint ,this enables the camera left or right.
- 2 loosen the screw and adjust to the position you want (up or down).
- 3 loosen the screw on each side, to rotate the camera left or right.

Positioning the Cables

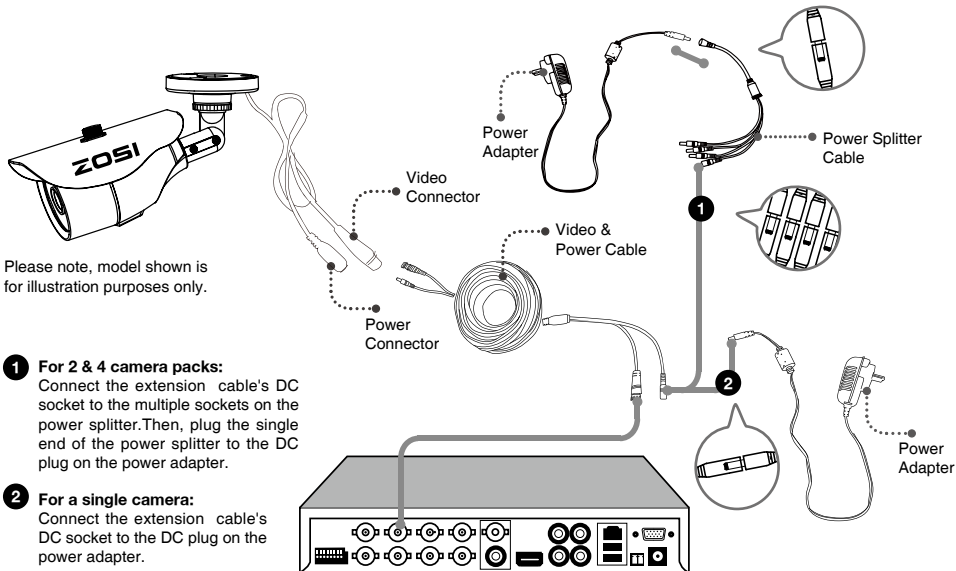

Troubleshooting

Q: Video Loss appears where the image from my camera should be displaying on my DVR?

A: 1. Check the extension cable (power and video) is securely connected to the camera.

2. Check the video output from the camera is securely connected to a video input channel on the DVR.

3. Check the power from the camera is securely connected to a power supply.

Q: When I view an image from the camera at night I only see a bright spot and no image?

A: A reflection can be caused in night vision mode if the camera is looking through a window. At night, the infrared light the camera uses to see in the dark can 'bounce back' off a reflective surface (such as glass, water, spider webs, some ceramics and so on) and effectively blind the camera. If you want to see outside, mount the camera outside - we made it weatherproof for a reason!

Q: The BNC extension cable will not connect to my TV?

A: Many TV's and monitors do not have a BNC connector but do have an RCA connector. Connect a BNC to RCA adapter to the end of the extension cable and then plug into the RCA video input on your TV or monitor.

Limited Warranty Terms & Conditions

ZOSI Communications warrants this product against defects in workmanship and material for a period of one year from its original purchase date. You must present your receipt as proof of date of purchase for warranty validation. Any unit which proves defective during the stated period will be repaired without charge for parts or labour or replaced at the sole discretion of ZOSI. The end user is responsible for all freight charges incurred to send the product to ZOSI's repair centres. The end user is responsible for all shipping costs incurred when shipping from and to any country other than the country of origin.

The warranty does not cover any incidental, accidental or consequential damages arising from the use of or the inability to use this product. Any costs associated with the fitting or removal of this product by a tradesman or other person or any other costs associated with its use are the responsibility of the end user. This warranty applies to the original purchaser of the product only and is not transferable to any third party. Unauthorized end user or third party modifications to any component or evidence of misuse or abuse of the device will render all warranties void.

By law some countries do not allow limitations on certain exclusions in this warranty. Where applicable by local laws, regulations and legal rights will take precedence.

ZOSI

PROFESSIONAL SECURITY MADE EASY

www.zositech.com
service@zositech.com

All rights reserved. No part of this publication may be reproduced by any means without written permission from ZOSI. The information in this publication is believed to be accurate in all respects.

ZOSI cannot assume responsibility for any consequences resulting from the use thereof. The information contained herein is subject to change without notice. Revisions or new editions to this publication may be issued to incorporate such changes.



PACKAGING

