

Service Manual

Air Conditioner

**Indoor Unit
CS-ME5RKUA
CS-ME7RKUA**

**Destination
USA
Canada**

Simplified



Please file and use this manual together with the service manual for Model No. CU-2E18NBU, CU-5E36QBU and CU-3E19RBU CU-4E24RBU, Order No. PHAAM111120A1, PAPAMY1312037CE and PAPAMY1505100CE.

WARNING

This service information is designed for experienced repair technicians only and is not designed for use by the general public. It does not contain warnings or cautions to advise non-technical individuals of potential dangers in attempting to service a product. Products powered by electricity should be serviced or repaired only by experienced professional technicians. Any attempt to service or repair the products dealt with in this service information by anyone else could result in serious injury or death.

PRECAUTION OF LOW TEMPERATURE

In order to avoid frostbite, be assured of no refrigerant leakage during the installation or repairing of refrigerant circuit.



Panasonic®

TABLE OF CONTENTS

1. Safety Precautions	3
2. Specification	5
3. Features.....	9
4. Location of Controls and Components.....	10
4.1 Indoor Unit.....	10
4.2 Outdoor Unit	10
4.3 Remote Control	10
5. Dimensions	11
5.1 Indoor Unit.....	11
6. Wiring Connection Diagram	12
6.1 Indoor Unit.....	12
7. Electronic Circuit Diagram	13
7.1 Indoor Unit.....	13
8. Printed Circuit Board	14
8.1 Indoor Unit.....	14
9. Installation Instruction	16
9.1 Select the Best Location.....	16
9.2 Indoor Unit.....	17
10. Operation Control.....	21
10.1 Basic Function	21
10.2 Cooling operation	21
10.3 Soft Dry Operation.....	21
10.4 Heating Operation	21
10.5 Automatic Operation.....	22
10.6 Indoor Fan Speed Control	22
10.7 Indoor Fan Motor Operation	23
10.8 Outdoor Fan Motor Operation	24
10.9 Airflow Direction.....	24
10.10 Quiet Operation (Cooling Mode/Cooling Area of Dry Mode)	25
10.11 Quiet Operation (Heating)	25
10.12 Powerful Mode Operation.....	25
10.13 Timer Control.....	26
10.14 Auto Restart Control.....	26
10.15 Indication Panel.....	26
10.16 ECONAVI and AUTO COMFORT Operation.....	27
11. Servicing Mode.....	30
11.1 Auto Off/On Button	30
11.2 Remote Control Button.....	31
12. Troubleshooting Guide.....	32
12.1 Refrigeration Cycle System.....	32
12.2 Breakdown Self Diagnosis Function.....	34
12.3 Error Code Table	35
12.4 Self-diagnosis Method	37
13. Disassembly and Assembly Instructions	67
13.1 Indoor Electronic Controllers, Cross Flow Fan and Indoor Fan Motor Removal Procedures	67
14. Exploded View and Replacement Parts List	71
14.1 Indoor Unit.....	71

1. Safety Precautions











- Read the following “SAFETY PRECAUTIONS” carefully before perform any servicing.
- Electrical work must be installed or serviced by a licensed electrician. Be sure to use the correct rating of the power plug and main circuit for the model installed.
- The caution items stated here must be followed because these important contents are related to safety. The meaning of each indication used is as below. Incorrect installation or servicing due to ignoring of the instruction will cause harm or damage, and the seriousness is classified by the following indications.

 WARNING	This indication shows the possibility of causing death or serious injury
 CAUTION	This indication shows the possibility of causing injury or damage to properties.

- The items to be followed are classified by the symbols:

	This symbol denotes item that is PROHIBITED from doing.
---	---





- Carry out test run to confirm that no abnormality occurs after the servicing. Then, explain to user the operation, care and maintenance as stated in instructions. Please remind the customer to keep the operating instructions for future reference.

 WARNING	
1.	Do not install outdoor unit near handrail of veranda. When installing air-conditioner unit on veranda of a high rise building, child may climb up to outdoor unit and cross over the handrail causing an accident. 
2.	Do not use unspecified cord, modified cord, joint cord or extension cord for power supply cord. Do not share the single outlet with other electrical appliances. Poor contact, poor insulation or over current will cause electrical shock or fire. 
3.	Do not tie up the power supply cord into a bundle by band. Abnormal temperature rise on power supply cord may happen. 
4.	Do not insert your fingers or other objects into the unit, high speed rotating fan may cause injury.  
5.	Do not sit or step on the unit, you may fall down accidentally.  
6.	Keep plastic bag (packaging material) away from small children, it may cling to nose and mouth and prevent breathing. 
7.	When installing or relocating air conditioner, do not let any substance other than the specified refrigerant, eg. air etc mix into refrigeration cycle (piping). Mixing of air etc. will cause abnormal high pressure in refrigeration cycle and result in explosion, injury etc. 
8.	Do not add or replace refrigerant other than specified type. It may cause product damage, burst and injury etc. 
9.	For R410A model, use piping, flare nut and tools which is specified for R410A refrigerant. Using of existing (R22) piping, flare nut and tools may cause abnormally high pressure in the refrigerant cycle (piping), and possibly result in explosion and injury. Thickness or copper pipes used with R410A must be more than 1/32" (0.8 mm). Never use copper pipes thinner than 1/32" (0.8 mm). It is desirable that the amount of residual oil is less than 0.0008 oz/ft (40 mg/10 m).
10.	Engage authorized dealer or specialist for installation. If installation done by the user is incorrect, it will cause water leakage, electrical shock or fire.
11.	Install according to this installation instructions strictly. If installation is defective, it will cause water leakage, electrical shock or fire.
12.	Use the attached accessories parts and specified parts for installation. Otherwise, it will cause the set to fall, water leakage, fire or electrical shock.
13.	Install at a strong and firm location which is able to withstand weight of the set. If the strength is not enough or installation is not properly done, the set will drop and cause injury.
14.	For installation work, follow all electrical, building, plumbing, local codes, regulations and these installation instructions. If electrical circuit capacity is not enough or a defect is found in electrical work, it will cause electrical shock or fire.
15.	Do not use spliced wires for indoor / outdoor connection cable. Use the specified indoor / outdoor connection cable, refer to instruction INDOOR UNIT ELECTRICAL WIRING and connect tightly for indoor connection. Clamp the cable so that no external force will have impact on the terminal. If connection or fixing is not perfect, it will cause heat-up or fire at the connection.
16.	Wire routing must be properly arranged so that control board cover is fixed properly. If control board cover is not fixed perfectly, it will cause fire or electrical shock.
17.	This equipment must installed with an Earth Leakage Circuit Breaker (ELCB) or Ground Fault Current Interrupter (GFCI) or Appliance Leakage Current Interrupter (ALCI) that has been certified by an NRTL Certified Testing Agency and that is suitable for the voltages and amperages involved. Otherwise, it may cause electrical shock and fire in case of equipment breakdown.
18.	During installation, install the refrigerant piping properly before running the compressor. Operation of compressor without fixing refrigeration piping and valves at opened position will cause suck-in of air, abnormal high pressure in refrigeration cycle and result in explosion, injury etc.
19.	During pump down operation, stop the compressor before removing the refrigeration piping. Removal of refrigeration piping while compressor is operating and valves are opened will cause suck-in of air, abnormal high pressure in refrigeration cycle and result in explosion, injury etc.
20.	Tighten the flare nut with torque wrench according to specified method. If the flare nut is over-tightened, after a long period, the flare may break and cause refrigerant gas leakage.

 **WARNING**

- | | |
|-----|---|
| 21. | After completion of installation, confirm there is no leakage of refrigerant gas. It may generate toxic gas when the refrigerant contacts with fire. |
| 22. | Ventilate if there is refrigerant gas leakage during operation. It may cause toxic gas when the refrigerant contacts with fire. |
| 23. | This equipment must be properly earthed. Earth line must not be connected to gas pipe, water pipe, earth of lightning rod and telephone. Otherwise, it may cause electrical shock in case of equipment breakdown or insulation breakdown. |

 **CAUTION**

- | | |
|----|--|
| 1. | Do not install the unit in a place where leakage of flammable gas may occur. In case gas leaks and accumulates at surrounding of the unit, it may cause fire.  |
| 2. | Do not release refrigerant during piping work for installation, re-installation and during repairing refrigeration parts. Take care of the liquid refrigerant, it may cause frostbite.  |
| 3. | Do not install this appliance in a laundry room or other location where water may drip from the ceiling, etc.  |
| 4. | Do not touch the sharp aluminium fin, sharp parts may cause injury.   |
| 5. | Carry out drainage piping as mentioned in installation instructions. If drainage is not perfect, water may enter the room and damage the furniture. |
| 6. | Select an installation location which is easy for maintenance. |
| 7. | Installation work.
It may need two people to carry out the installation work. |

2. Specification

Model		Indoor	CS-ME5RKUA						CS-ME7RKUA						
		Outdoor	CU-3E19RBU						CU-3E19RBU						
Performance Test Condition			AHRI						AHRI						
Power Supply		Phase, Hz	Single, 60						Single, 60						
		V	208			230			208			230			
			Min.	Mid.	Max.	Min.	Mid.	Max.	Min.	Mid.	Max.	Min.	Mid.	Max.	
Cooling	Capacity	kW	1.30	1.62	2.30	1.30	1.62	2.30	1.80	2.01	2.90	1.80	2.01	2.90	
		BTU/h	4400	5500	7800	4400	5500	7800	6100	6900	9900	6100	6900	9900	
	Running Current	A	-	2.3	-	-	2.0	-	-	2.8	-	-	2.5	-	
	Input Power	W	250	400	640	250	400	640	340	500	810	340	500	810	
	EER	W/W	5.20	4.05	3.59	5.20	4.05	5.20	5.29	4.02	3.58	5.29	4.02	3.58	
		Btu/hW	17.60	13.75	12.20	17.60	13.75	12.20	17.95	13.80	12.20	17.95	13.80	12.20	
	Indoor Noise (H / L)	dB-A	38 / 25			38 / 25			39 / 25			39 / 25			
Power Level dB		54 / -			54 / -			55 / -			55 / -				
Heating	Capacity	kW	1.20	2.61	3.20	1.20	2.61	3.20	1.20	3.21	4.10	1.20	3.21	4.10	
		BTU/h	4100	8900	10900	4100	8900	10900	4100	10900	14000	4100	10900	14000	
	Running Current	A	-	3.4	-	-	3.0	-	-	4.1	-	-	3.7	-	
	Input Power	W	300	600	960	300	600	960	300	740	1.23k	300	740	1.23k	
	COP	W/W	4.00	4.35	3.33	4.00	4.35	3.33	4.00	4.34	3.33	4.00	4.34	3.33	
		Btu/hW	13.65	14.85	11.35	13.65	14.85	11.35	13.65	14.75	11.40	13.65	14.75	11.40	
	Indoor Noise (H / L)	dB-A	40 / 29			40 / 29			41 / 29			41 / 29			
Power Level dB		56 / -			56 / -			57 / -			57 / -				
Indoor Fan	Type		Cross-flow fan						Cross-flow fan						
	Material		ASG20K1						ASG20K1						
	Motor Type		DC (8 poles)						DC (8 poles)						
	Input Power	W	47.0 - 47.0						47.0 - 47.0						
	Output Power	W	40						40						
	Speed	QLo	rpm	Cooling : 570 Heating : 690						Cooling : 570 Heating : 690					
		Lo	rpm	Cooling : 660 Heating : 780						Cooling : 660 Heating : 780					
		Me	rpm	Cooling : 820 Heating : 950						Cooling : 840 Heating : 960					
		Hi	rpm	Cooling : 990 Heating : 1120						Cooling : 1020 Heating : 1150					
		SHi	rpm	Cooling : 1080 Heating : 1210						Cooling : 1100 Heating : 1240					
Moisture Removal	L/h (Pt/h)	0.3 (0.6)						0.4 (0.8)							
Indoor Airflow	QLo	m ³ /min (ft ³ /min)	Cooling : 6.00 (212) Heating : 6.88 (243)						Cooling : 6.06 (214) Heating : 6.95 (245)						
	Lo	m ³ /min (ft ³ /min)	Cooling : 7.00 (247) Heating : 7.89 (279)						Cooling : 7.06 (249) Heating : 7.96 (281)						
	Me	m ³ /min (ft ³ /min)	Cooling : 8.80 (311) Heating : 9.79 (346)						Cooling : 9.08 (321) Heating : 9.97 (352)						
	Hi	m ³ /min (ft ³ /min)	Cooling : 10.70 (380) Heating : 11.70 (415)						Cooling : 11.10 (390) Heating : 12.10 (425)						
	SHi	m ³ /min (ft ³ /min)	Cooling : 11.71 (413) Heating : 12.70 (448)						Cooling : 12.10 (425) Heating : 13.11 (463)						
Dimension	Height (I/D)	mm (inch)	290 (11-7/16)						290 (11-7/16)						
	Width (I/D)	mm (inch)	870 (34-9/32)						870 (34-9/32)						
	Depth (I/D)	mm (inch)	214 (8-7/16)						214 (8-7/16)						
Weight	Net (I/D)	kg (lb)	9 (20)						9 (20)						
Pipe Diameter (Liquid / Gas)	mm (inch)	6.35 (1/4) / 9.52 (3/8)						6.35 (1/4) / 9.52 (3/8)							
Drain Hose	Inner Diameter	mm (inch)	16.7 (5/8)						16.7 (5/8)						
	Length	mm (inch)	650 (25-5/8)						650 (25-5/8)						

Model		Indoor	CS-ME5RKUA		CS-ME7RKUA	
		Outdoor	CU-3E19RBU		CU-3E19RBU	
Indoor Heat Exchanger	Fin Material		Aluminium (Pre Coat)		Aluminium (Pre Coat)	
	Fin Type		Slit Fin		Slit Fin	
	Row x Stage x FPI		2 x 15 x 21		2 x 15 x 21	
	Size (W x H x L)	inch	1 x 12-13/32 x 24		1 x 12-13/32 x 24	
Air Filter	Material		Polypropelene		Polypropelene	
	Type		One-touch		One-touch	
			DRY BULB	WET BULB	DRY BULB	WET BULB
Indoor Operation Range (Cooling) (°F / °C)		Maximum	89.6 / 32	73.4 / 23	89.6 / 32	73.4 / 23
		Minimum	60.8 / 16	51.8 / 11	60.8 / 16	51.8 / 11
Indoor Operation Range (Heating) (°F / °C)		Maximum	86.0 / 30	- / -	86.0 / 30	- / -
		Minimum	60.8 / 16	- / -	60.8 / 16	- / -

1. Cooling capacities are based on indoor temperature of 27°C DRY BULB (80.6°F DRY BULB), 19.0°C WET BULB (66°F WET BULB) and outdoor air temperature of 35°C DRY BULB (95°F DRY BULB), 24°C WET BULB (75.2°F WET BULB)
2. Heating capacities are based on indoor temperature of 20°C Dry Bulb (68°F Dry Bulb) and outdoor air temperature of 7°C Dry Bulb (44.6°F Dry Bulb), 6°C Wet Bulb (42.8°F Wet Bulb)
3. Specifications are subjected to change without prior notice for further improvement.

Model		Indoor	CS-ME7RKUA						CS-ME7RKUA						
		Outdoor	CU-2E18NBU						CU-5E36QBU						
Performance Test Condition			AHRI						AHRI						
Power Supply		Phase, Hz	Single, 60						Single, 60						
		V	208			230			208			230			
			Min.	Mid.	Max.	Min.	Mid.	Max.	Min.	Mid.	Max.	Min.	Mid.	Max.	
Cooling	Capacity	kW	1.80	2.01	2.90	1.80	2.01	2.90	1.80	2.01	2.90	1.80	2.01	2.90	
		BTU/h	6100	6900	9900	6100	6900	4900	6100	6900	9900	6100	6900	9900	
	Running Current	A	-	2.8	-	-	2.5	-	-	2.8	-	-	2.5	-	
	Input Power	W	340	500	810	340	500	810	340	500	810	340	500	810	
	EER	W/W	5.29	4.02	3.58	5.29	4.02	3.58	5.29	4.02	3.58	5.29	4.02	3.58	
		Btu/hW	17.95	13.80	12.20	17.95	13.80	12.20	17.95	13.80	12.20	17.95	13.80	12.20	
	Indoor Noise (H / L)	dB-A	39 / 25			39 / 25			39 / 25			39 / 25			
Power Level dB		55 / -			55 / -			55 / -			55 / -				
Heating	Capacity	kW	1.20	3.21	4.10	1.20	3.21	4.10	1.20	3.21	4.10	1.20	3.21	4.10	
		BTU/h	4100	10900	14000	4100	10900	14000	4100	10900	14000	4100	10900	14000	
	Running Current	A	-	4.1	-	-	3.7	-	-	4.1	-	-	3.27	-	
	Input Power	W	300	740	1.23k	300	740	1.23k	300	740	1.23k	300	740	1.23k	
	COP	W/W	4.00	4.34	3.33	4.00	4.34	3.33	4.00	4.34	3.33	4.00	4.34	3.33	
		Btu/hW	13.65	14.75	11.40	13.65	14.75	11.40	13.65	14.75	11.40	13.65	14.75	11.40	
	Indoor Noise (H / L)	dB-A	41 / 29			41 / 29			41 / 29			41 / 29			
Power Level dB		57 / -			57 / -			57 / -			57 / -				
Indoor Fan	Type	Cross-flow fan						Cross-flow fan							
	Material	ASG20K1						ASG20K1							
	Motor Type	DC (8 poles)						DC (8 poles)							
	Input Power	W	47.0 - 47.0						47.0 - 47.0						
	Output Power	W	40						40						
	Speed	QLo	rpm	Cooling : 570 Heating : 690						Cooling : 570 Heating : 690					
		Lo	rpm	Cooling : 660 Heating : 780						Cooling : 660 Heating : 780					
		Me	rpm	Cooling : 840 Heating : 960						Cooling : 840 Heating : 960					
		Hi	rpm	Cooling : 1020 Heating : 1150						Cooling : 1020 Heating : 1150					
		SHi	rpm	Cooling : 1100 Heating : 1240						Cooling : 1100 Heating : 1240					
	Moisture Removal	L/h (Pt/h)	0.4 (0.8)						0.4 (0.8)						
Indoor Airflow	QLo	m ³ /min (ft ³ /min)	Cooling : 6.06 (214) Heating : 6.95 (245)						Cooling : 6.06 (214) Heating : 6.95 (245)						
	Lo	m ³ /min (ft ³ /min)	Cooling : 7.06 (249) Heating : 7.96 (281)						Cooling : 7.06 (249) Heating : 7.96 (281)						
	Me	m ³ /min (ft ³ /min)	Cooling : 9.08 (321) Heating : 9.97 (352)						Cooling : 9.08 (321) Heating : 9.97 (352)						
	Hi	m ³ /min (ft ³ /min)	Cooling : 11.10 (390) Heating : 12.10 (425)						Cooling : 11.10 (390) Heating : 12.10 (425)						
	SHi	m ³ /min (ft ³ /min)	Cooling : 12.10 (425) Heating : 13.11 (463)						Cooling : 12.10 (425) Heating : 13.11 (463)						
Dimension	Height (I/D)	mm (inch)	290 (11-7/16)						290 (11-7/16)						
	Width (I/D)	mm (inch)	870 (34-9/32)						870 (34-9/32)						
	Depth (I/D)	mm (inch)	214 (8-7/16)						214 (8-7/16)						
Weight	Net (I/D)	kg (lb)	9 (20)						9 (20)						
Pipe Diameter (Liquid / Gas)	mm (inch)	6.35 (1/4) / 9.52 (3/8)						6.35 (1/4) / 9.52 (3/8)							
Drain Hose	Inner Diameter	mm (inch)	16.7 (5/8)						16.7 (5/8)						
	Length	mm (inch)	650 (25-5/8)						650 (25-5/8)						

Model		Indoor	CS-ME7RKUA		CS-ME7RKUA	
		Outdoor	CU-2E18NBU		CU-5E36QBU	
Indoor Heat Exchanger	Fin Material		Aluminium (Pre Coat)		Aluminium (Pre Coat)	
	Fin Type		Slit Fin		Slit Fin	
	Row x Stage x FPI		2 x 15 x 21		2 x 15 x 21	
	Size (W x H x L)	inch	1 x 12-13/32 x 24		1 x 12-13/32 x 24	
Air Filter	Material		Polypropelene		Polypropelene	
	Type		One-touch		One-touch	
			DRY BULB	WET BULB	DRY BULB	WET BULB
Indoor Operation Range (Cooling) (°F / °C)		Maximum	89.6 / 32	73.4 / 23	89.6 / 32	73.4 / 23
		Minimum	60.8 / 16	51.8 / 11	60.8 / 16	51.8 / 11
Indoor Operation Range (Heating) (°F / °C)		Maximum	86.0 / 30	- / -	86.0 / 30	- / -
		Minimum	60.8 / 16	- / -	60.8 / 16	- / -

1. Cooling capacities are based on indoor temperature of 27°C DRY BULB (80.6°F DRY BULB), 19.0°C WET BULB (66°F WET BULB) and outdoor air temperature of 35°C DRY BULB (95°F DRY BULB), 24°C WET BULB (75.2°F WET BULB)
2. Heating capacities are based on indoor temperature of 20°C Dry Bulb (68°F Dry Bulb) and outdoor air temperature of 7°C Dry Bulb (44.6°F Dry Bulb), 6°C Wet Bulb (42.8°F Wet Bulb)
3. Specifications are subjected to change without prior notice for further improvement.

3. Features

- **Inverter Technology**
 - Wider output power range
 - Energy saving
 - Quick Cooling
 - More precise temperature control
- **Environment Protection**
 - Non-ozone depletion substances refrigerant (R410A)
- **Long Installation Piping**
 - Long piping up to 82 feet (25 meters) for 1 room, 164 feet (50 meters) for total room
- **Easy to use remote control**
- **Quality Improvement**
 - Random auto restart after power failure for safety restart operation
 - Gas leakage protection
 - Prevent compressor reverse cycle
 - Inner protector to protect Compressor
 - Noise prevention during soft dry operation
- **Operation Improvement**
 - Quiet mode to reduce the indoor unit operating sound
 - Powerful mode to reach the desired room temperature quickly
- **Serviceability Improvement**
 - Breakdown Self Diagnosis function

4. Location of Controls and Components

4.1 Indoor Unit

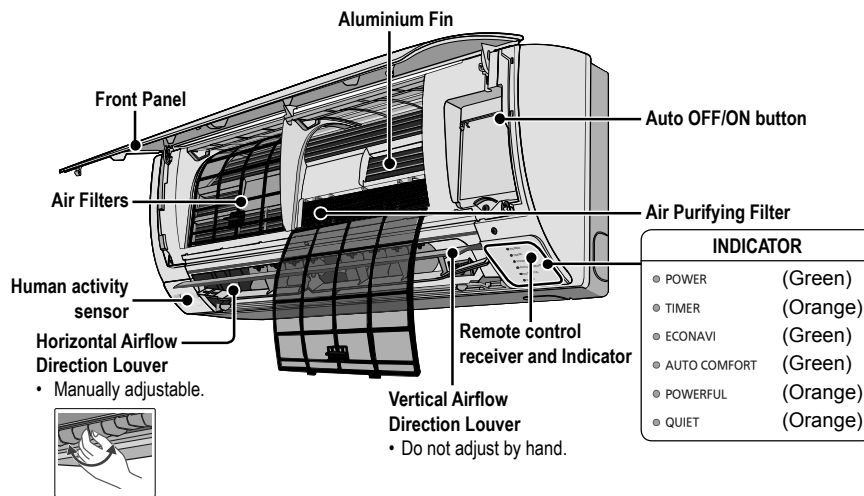

4.2 Outdoor Unit

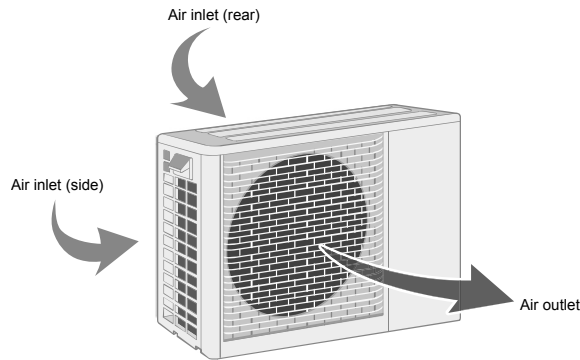

4.3 Remote Control

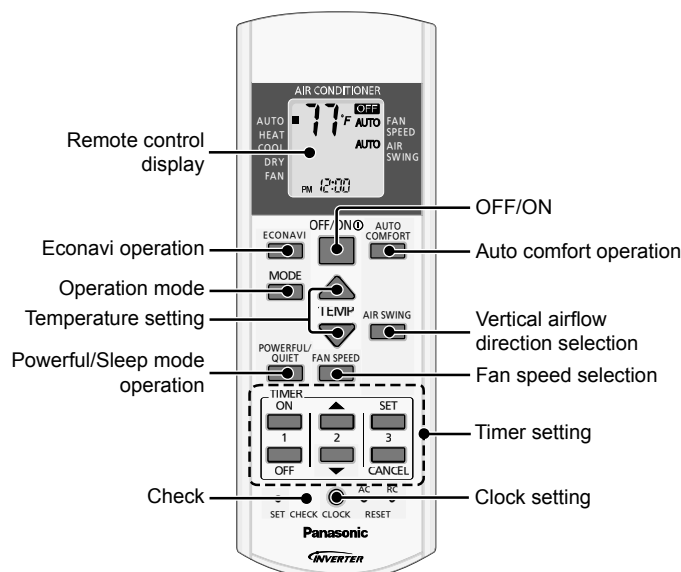

5. Dimensions

5.1 Indoor Unit

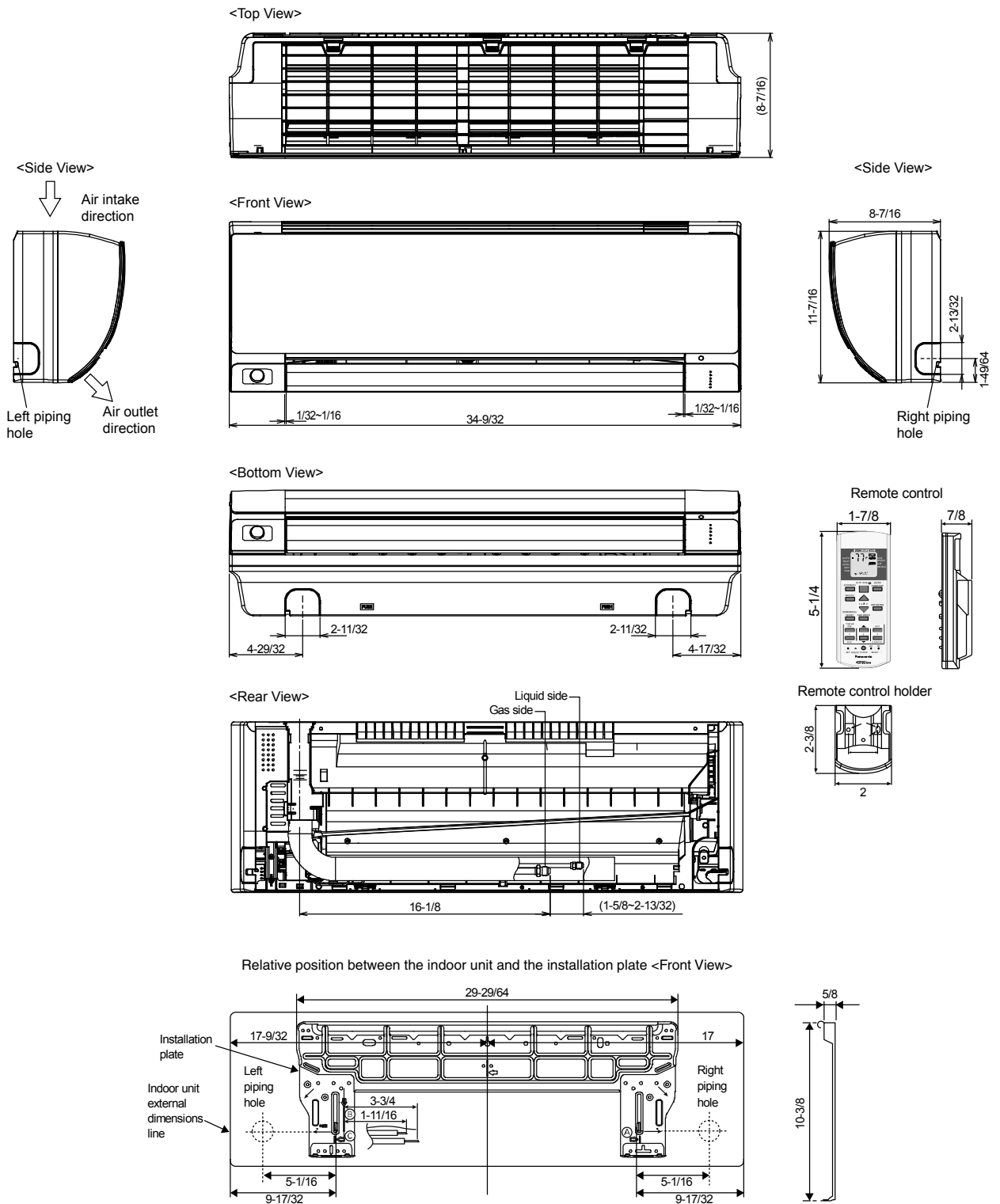

Unit: inch



7. Electronic Circuit Diagram

7.1 Indoor Unit

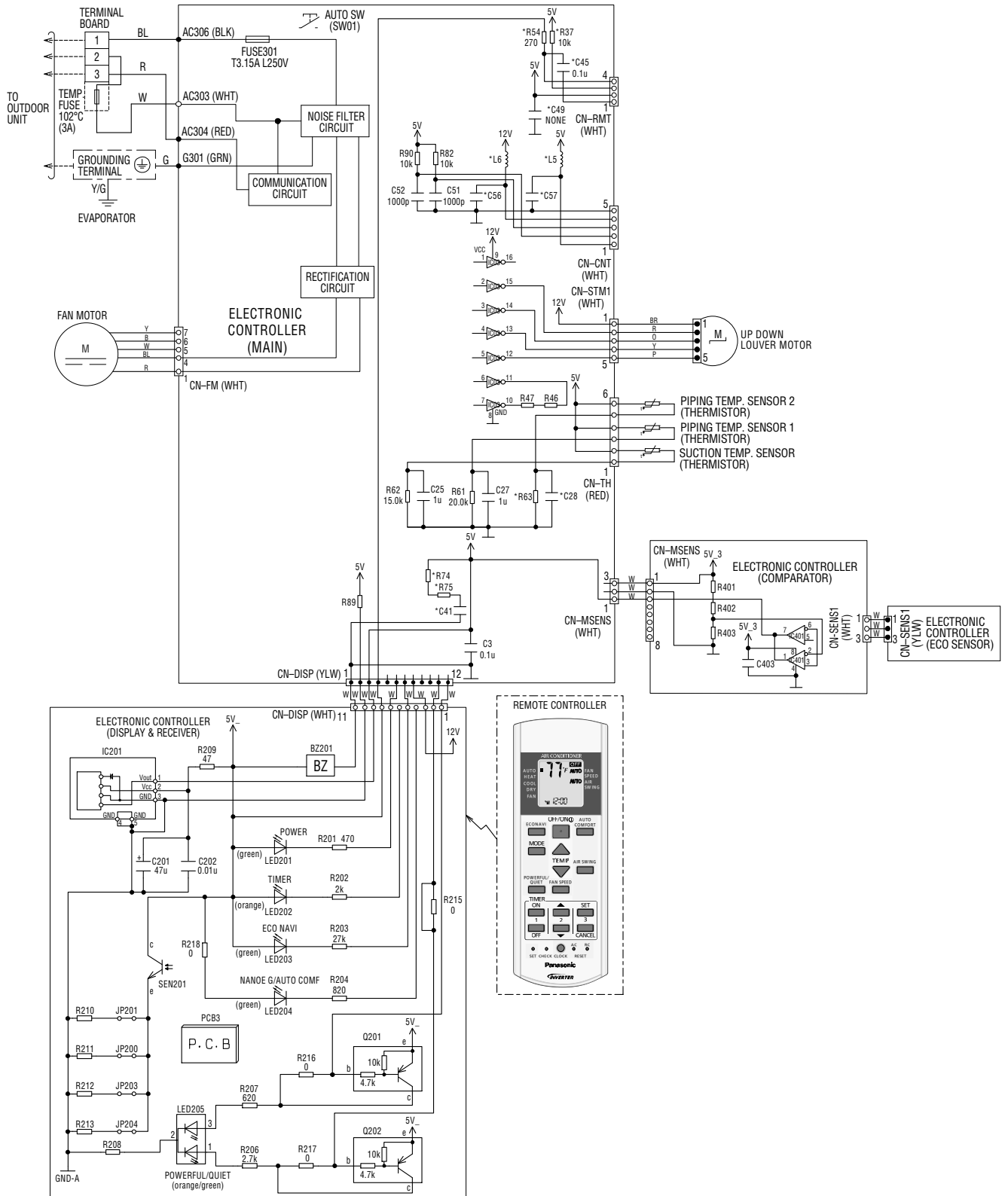

8.1.3 Comparator Printed Circuit Board

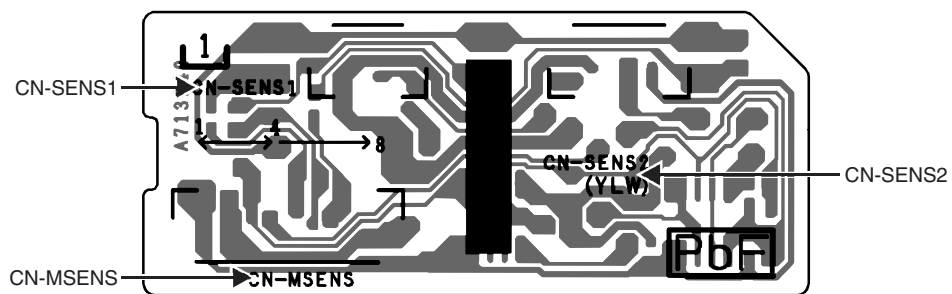

9. Installation Instruction

9.1 Select the Best Location

9.1.1 Indoor Unit

- Do not install the unit in excessive oil fume area such as kitchen, workshop and etc.
- There should not be any heat source or steam near the unit.
- There should not be any obstacles blocking the air circulation.
- A place where air circulation in the room is good.
- A place where drainage can be easily done.
- A place where noise prevention is taken into consideration.
- Do not install the unit near the door way.
- Ensure the spaces indicated by arrows from the wall, ceiling, fence or other obstacles.
- Mount with the lowest moving parts at least 8 ft (2.4 m) above floor or grade level.

9.1.2 Indoor/Outdoor Unit Installation Diagram

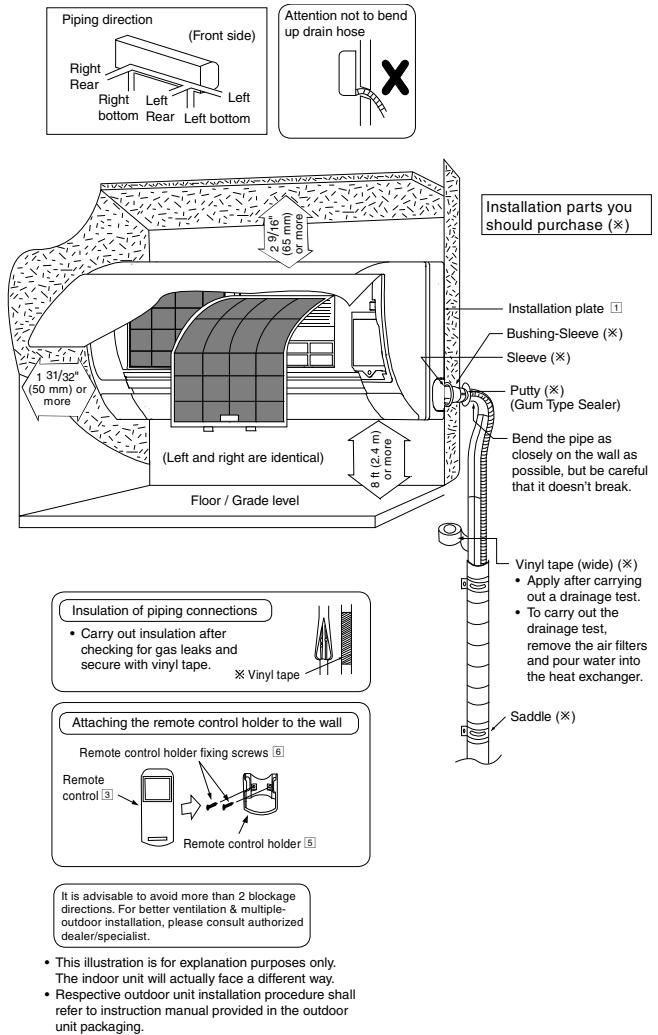

9.2 Indoor Unit

9.2.1 How to Fix Installation Plate

The mounting wall shall be strong and solid enough to prevent it from the vibration.

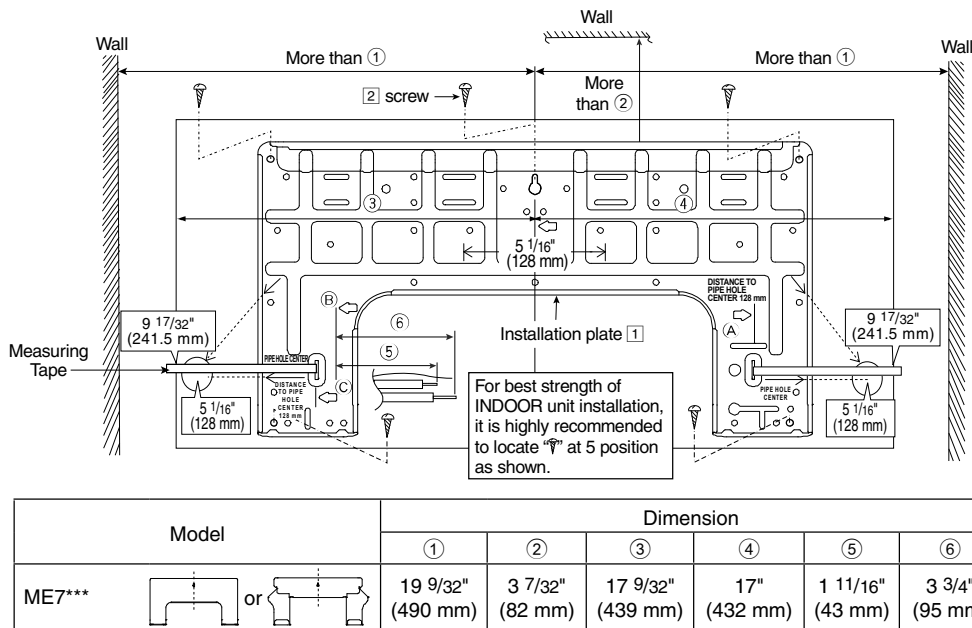

The center of installation plate should be at more than ① at right and left of the wall.

The distance from installation plate edge to ceiling should more than ②.

From installation plate center to unit's left side is ③.

From installation plate center to unit's right side is ④.

- Ⓑ : For left side piping, piping connection for liquid should be about ⑤ from this line.
: For left side piping, piping connection for gas should be about ⑥ from this line.

- Mount the installation plate on the wall with 5 screws or more (at least 5 screws).
(If mounting the unit on the concrete wall, consider using anchor bolts.)
 - Always mount the installation plate horizontally by aligning the marking-off line with the thread and using a level gauge.
- Drill the piping plate hole with $\phi 2 \frac{3}{4}$ " ($\phi 70$ mm) hole-core drill.
 - Line according to the left and right side of the installation plate. The meeting point of the extended line is the center of the hole. Another method is by putting measuring tape at position as shown in the diagram above. The hole center is obtained by measuring the distance namely $5 \frac{1}{16}$ " (128 mm) for left and right hole respectively.
 - Drill the piping hole at either the right or the left and the hole should be slightly slanting to the outdoor side.

9.2.2 To Drill a Hole in the Wall and Install a Sleeve of Piping

- Insert the piping sleeve to the hole.
- Fix the bushing to the sleeve.
- Cut the sleeve until it extrudes about $\frac{19}{32}$ " (15 mm) from the wall.

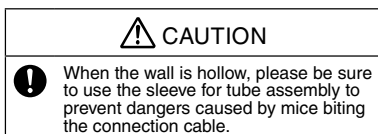

- Finish by sealing the sleeve with putty or caulking compound at the final stage.

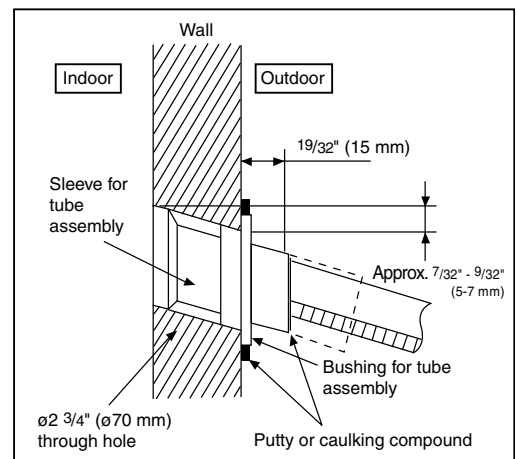

9.2.3 Indoor Unit Installation

Do not turn over the unit without its shock absorber during pull out the piping.
It may cause intake grille damage.
Use shock absorber during pull out the piping to protect the intake grille from damage.

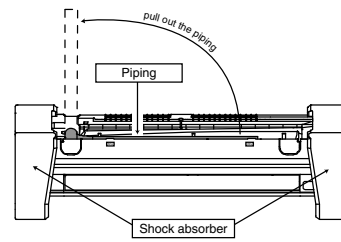
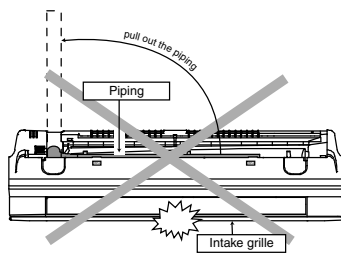

9.2.3.1 For the right rear piping

- Step-1** Pull out the Indoor piping
- Step-2** Install the Indoor Unit
- Step-3** Secure the Indoor Unit
- Step-4** Insert the connection cable

9.2.3.2 For the right bottom piping

- Step-1** Pull out the Indoor piping
- Step-2** Install the Indoor Unit
- Step-3** Insert the connection cable
- Step-4** Secure the Indoor Unit

9.2.3.3 For the embedded piping

- Step-1** Replace the drain hose
- Step-2** Bend the embedded piping
 - Use a spring bender or equivalent to bend the piping so that the piping is not crushed.
- Step-3** Pull the connection cable into Indoor Unit
 - The inside and outside connection cable can be connected without removing the front grille.
- Step-4** Cut and flare the embedded piping
 - When determining the dimensions of the piping, slide the unit all the way to the left on the installation plate.
 - Refer to the section "Cutting and flaring the piping".
- Step-5** Install the Indoor Unit
- Step-6** Connect the piping
 - Please refer to "Connecting the piping" column in outdoor unit section. (Below steps are done after connecting the outdoor piping and gas-leakage confirmation.)
- Step-7** Insulate and finish the piping
 - Please refer to "Insulation of piping connection" column as mentioned in indoor/outdoor unit installation.
- Step-8** Secure the Indoor Unit

Right Rear piping

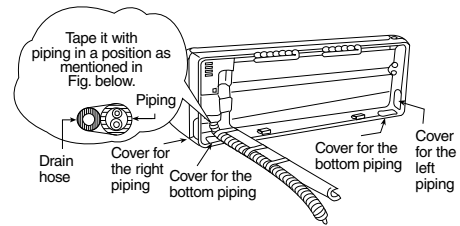

How to keep the cover

In case of the cover is cut, keep the cover at the rear of chassis as shown in the illustration for future reinstallation.
(Left, right and 2 bottom covers for piping.)

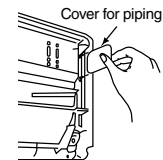

Right and Right Bottom piping

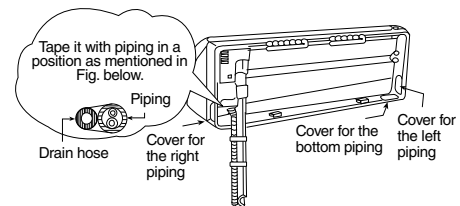

Install the indoor unit

Hook the indoor unit onto the upper portion of installation plate. (Engage the indoor unit with the upper edge of the installation plate). Ensure the hooks are properly seated on the installation plate by moving it in left and right.

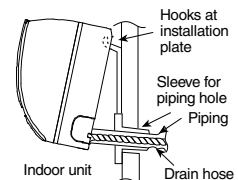

Secure the Indoor Unit

1. Press the lower left and right side of the unit against the installation plate until hooks engages with their slot (sound click).

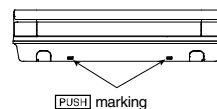
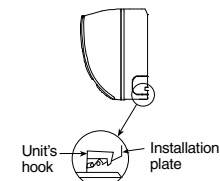

To take out the unit, push the **[PUSH]** marking at the bottom unit, and pull it slightly towards you to disengage the hooks from the unit.

Insert the connection cable

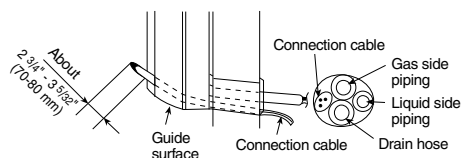

(This can be used for left rear piping and bottom piping also.)

Replace the drain hose

Rear view for left piping installation

Drain cap Drain hose

Connection cable

Adjust the piping slightly downwards.

Connection cable

Piping

Drain hose

More than 37 13/32" (950 mm)

Sleeve for piping hole

- How to pull the piping and drain hose out, in case of embedded piping.

Apply putty or caulking material to seal the wall opening.

More than 37 13/32" (950 mm)

Connection cable

Piping

Drain hose from main unit

PVC tube (VP-65) for piping and connection cable

PVC tube for drain hose (VP-20)

PVC tube for drain hose (VP-30)

More than 27 9/16" (700 mm)

18 1/2" (470 mm)

PVC tube for drain hose

Cable

Piping

Indoor unit

3 15/16" (100 mm)

- In case of left piping how to insert the connection cable and drain hose.

Drain hose

Cable

Piping

(For the right piping, follow the same procedure)

Drain hose adapter [8] usage

- Join indoor drain hose to 3/4" (20 mm) nominal PVC pipe size by using drain hose adapter [8] when necessary.

Remarks :

Make sure indoor unit drain hose & 3/4" (20 mm) nominal PVC pipe are fully inserted to drain hose adapter [8].

Indoor unit drain hose

Close join by Vinyl Tape (X)

Drain hose adapter [8]

3/4" (20 mm) nominal PVC pipe

- Install incline downward more than 1°
- Apply PVC glue at the join.

9.2.4 Connect the Cable to the Indoor Unit

- The inside and outside connection cable can be connected without removing the front grille.
- Unscrew the conduit cover and fix the conduit connector to conduit cover with lock nut, then secure it against chassis.
- Connection cable between indoor unit and outdoor unit should be UL listed or CSA approved 4 conductor wires minimum AWG16 in accordance with local electric codes.
 - Ensure the colour of wires of outdoor unit and terminal number are the same as the indoor's respectively

Terminals on the indoor unit	1	2	3	
Colour of wires (connection cable)	Grey	White	Blue	Green/Yellow
Terminals on the outdoor unit	1	2	3	

⚠ WARNING

This equipment must be properly earthed.

- Earth lead wire shall be Yellow/Green (Y/G) in colour and shall be longer than other lead wires as shown in the figure for electrical safety in case of the slipping.

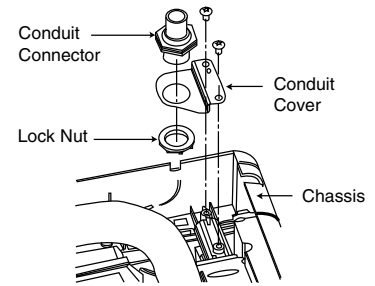

Rear Side of Indoor Unit

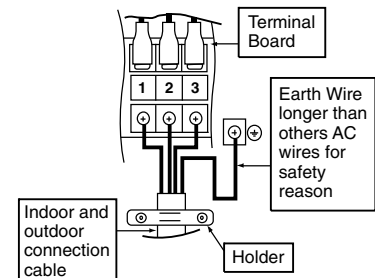

9.2.5 Wiring Stripping and connecting requirement

Wire stripping

No loose strand when inserted

Indoor/outdoor connection terminal board

7/32" (5 mm) or more
(gap between wires)

Conductor fully inserted

ACCEPT

Conductor over inserted

PROHIBITED

Conductor not fully inserted

PROHIBITED

WARNING

RISK OF FIRE
JOINING OF WIRES MAY CAUSE OVERHEATING AND FIRE.

Do not joint wires

- ❗ Use complete wire without joining.
- ❗ Use approved socket and plug with earth pin.
- ❗ Wire connection in this area must follow to national wiring rules.

9.2.5.1 Cutting and flaring the piping

- 1 Please cut using pipe cutter and then remove the burrs.
- 2 Remove the burrs by using reamer. If burrs is not removed, gas leakage may be caused. Turn the piping end down to avoid the metal powder entering the pipe.
- 3 Please make flare after inserting the flare nut onto the copper pipes.

1. To cut

2. To remove burrs

3. To flare

0 – 1/32" (0-0.5 mm)

Bar
Copper pipe

■ Improper flaring ■

Inclined Surface damaged Cracked Uneven thickness

When properly flared, the internal surface of the flare will evenly shine and be of even thickness. Since the flare part comes into contact with the connections, carefully check the flare finish.

10. Operation Control

10.1 Basic Function

Inverter control, which equipped with a microcomputer in determining the most suitable operation mode as time passes, automatically adjusts output power for maximum comfort always. In order to achieve the suitable operation mode, the microcomputer maintains the set temperature by measuring the temperature of the environment and performing temperature shifting. The compressor at outdoor unit is operating following the frequency instructed by the microcomputer at indoor unit that judging the condition according to internal setting temperature and intake air temperature.

10.1.1 Internal Setting Temperature

Once the operation starts, remote control setting temperature will be taken as base value for temperature shifting processes. These shifting processes are depending on the air conditioner settings and the operation environment. The final shifted value will be used as internal setting temperature and it is updated continuously whenever the electrical power is supplied to the unit.

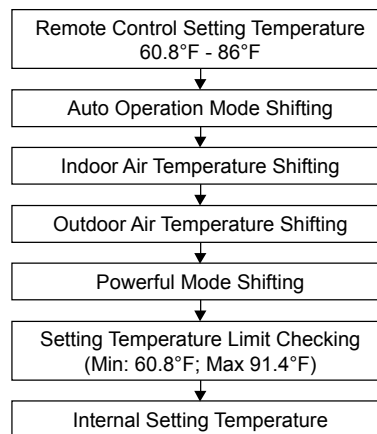

10.2 Cooling operation

10.2.1 Thermostat control

- Capability supply to indoor unit is OFF (Expansion valve closed) when Intake Air Temperature - Internal setting temperature $< -3.6^{\circ}\text{F}$.
- Capability resume supply to indoor unit after waiting for 3 minutes, if the Intake Air temperature - Internal setting temperature $>$ Capability supply OFF point.

10.3 Soft Dry Operation

10.3.1 Thermostat control

- Capability supply to indoor unit is OFF (Expansion valve closed) when Intake Air Temperature - Internal setting temperature $< -5.4^{\circ}\text{F}$.
- Capability resume to indoor unit after waiting for 3 minutes, if the Intake Air temperature - Internal setting temperature $>$ Capability supply OFF point.

10.4 Heating Operation

10.4.1 Thermostat control

- Capability supply to indoor unit is OFF (Expansion valve closed) when Intake Air Temperature - Internal setting temperature $> 1.8^{\circ}\text{F}$.
- During this condition, the indoor fan is stopped if compressor is ON.
- Capability resume supply to indoor unit after waiting for 3 minutes, if the Intake Air Temperature - Internal setting temperature $<$ Capability supply OFF point.

10.4.2 Temperature Sampling Control

- Temperature sampling is controlled by outdoor unit where room temperature for all power supply ON indoor unit could be obtained.
- When capability supply to the indoor unit is OFF and the compressor is ON during heating operation, the indoor fan motor is stopped. During this condition, 15 seconds after sampling signal from outdoor unit is received, the indoor fan start operation at low fan speed.
- However, within first 4 minutes of capability stopped supply to the indoor unit, even sampling signal is received, the sampling control is cancelled.

10.5 Automatic Operation

- This mode can be set using remote control and the operation is decided by remote control setting temperature, remote control operation mode, indoor intake and outdoor air temperature.
- During operation mode judgment, indoor fan motor (with speed of -Lo) and outdoor fan motor are running for 30 seconds to detect the indoor intake and outdoor air temperature. The operation mode is decided based on below chart.

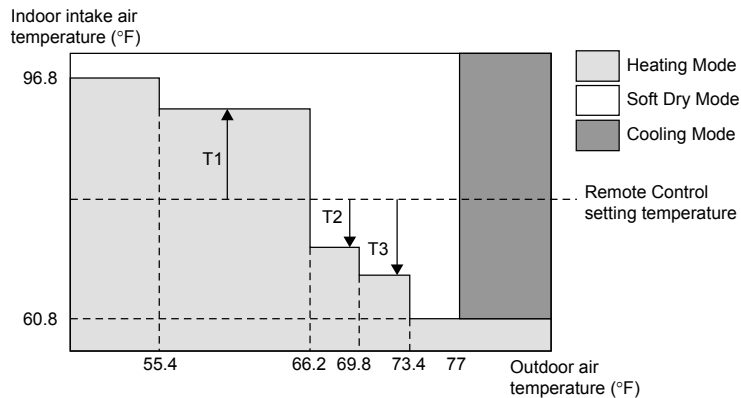

10.6 Indoor Fan Speed Control

- Indoor Fan Speed can be set using remote control.

10.6.1 Fan Speed Rotation Chart

			ME5RKUA	ME7RKUA
Mode	Fan Tap	Application	rpm	rpm
COOL	SHi	Pwr Me+	1080	1110
	Hi	Fc, RC	990	1020
	Me+	RC	900	930
	Me	RC	820	840
	Me-	RC	740	750
	Lo	Fcmin, RC	660	660
	Lo-	QuietLo	570	570
	SLo	Dry	550	550
	SSLo	Auto Cut	540	540

			ME5RKUA	ME7RKUA
Mode	Fan Tap	Application	rpm	rpm
HEAT	SSHHi	Pwr Me+	1210	1240
	SHi	Fh, RC	1120	1150
	Me+	RC	1030	1050
	Me	RC	950	960
	Me-	RC	860	870
	Lo	Fhmin, RC	780	780
	Lo-	QuietLo	690	690
	SLo	Thermo Off, Hot start	580	580
	SSLo	Thermo Off	570	570

10.7 Indoor Fan Motor Operation

10.7.1 Residual Heat Removal Control

- To prevent high pressure at indoor unit, when heating mode thermostat-off condition or power supply OFF, indoor fan continue to operate at controlled fan speed for maximum 30 seconds then stop.

10.7.2 Basic Rotation Speed (rpm)

- Manual Fan Speed

[Cooling, Dry]

- Fan motor's number of rotation is determined according to remote control setting.

Remote control	○	○	○	○	○
Tab	Hi	Me+	Me	Me-	Lo

[Heating]

- Fan motor's number of rotation is determined according to remote control setting.

Remote control	○	○	○	○	○
Tab	Shi	Me+	Me	Me-	Lo

- Auto Fan Speed

[Cooling, Dry]

- According to room temperature and setting temperature, indoor fan speed is determined automatically.
- The indoor fan will operate according to pattern below.

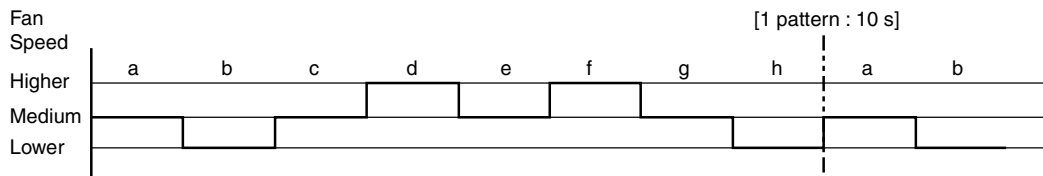

- During operation, indoor fan motor may stop due to odor prevention.

[Heating]

- According to indoor pipe temperature, automatic heating fan speed is determined as follows.

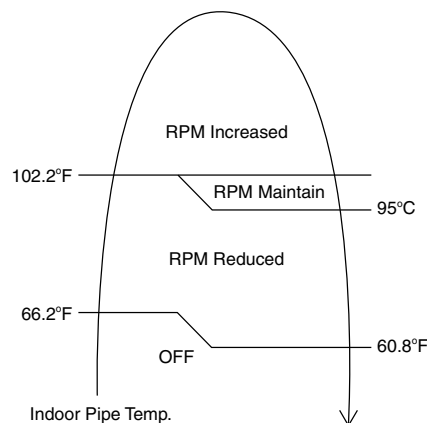

- Feedback control

- Immediately after the fan motor started, feedback control is performed once every second.
- During fan motor on, if fan motor feedback ≥ 2550 rpm or < 50 rpm continue for 10 seconds, then fan motor error counter increase, fan motor is then stop and restart. If the fan motor counter becomes 7 times, then H19 - fan motor error is detected. Operation stops and cannot on back.

10.8 Outdoor Fan Motor Operation

Outdoor fan motor is operated with fan speed number of rotation. It starts when compressor starts operation and it stops 30 seconds after compressor stops operation.

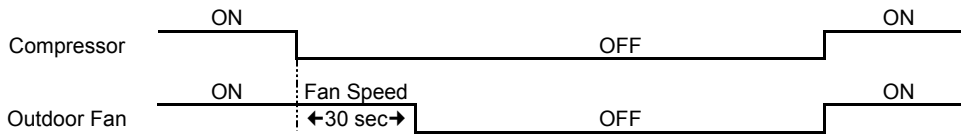

10.9 Airflow Direction

- There are two types of airflow, vertical airflow (directed by horizontal vane) and horizontal airflow (directed by vertical vanes).
- Control of airflow direction can be automatic (angles of direction is determined by operation mode, heat exchanger temperature and intake air temperature) and manual (angles of direction can be adjusted using remote control).

10.9.1 Vertical Airflow

Operation Mode	Airflow Direction	Vane angle (°)					
		1	2	3	4	5	
Heating	Auto with Heat Exchanger Temperature	A	20				
		B	57				
		C	32				
	Manual	20	32	45	57	68	
Cooling	Auto	20 ~ 45					
	Manual	20	26	32	37	45	
Soft Dry	Auto	20 ~ 45					
	Manual	20	26	32	37	45	

- Automatic vertical airflow direction can be set using remote control; the vane swings up and down within the angles as stated above. For heating mode operation, the angle of the vane depends on the indoor heat exchanger temperature as Figure 1 below. When the air conditioner is stopped using remote control, the vane will shift to close position.
- Manual vertical airflow direction can be set using remote control; the angles of the vane are as stated above and the positions of the vane are as Figure 2 below. When the air conditioner is stopped using remote control, the vane will shift to close position.

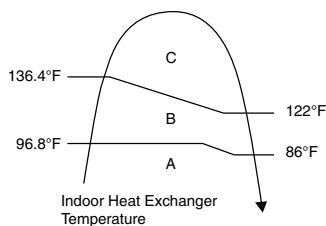

Figure 1

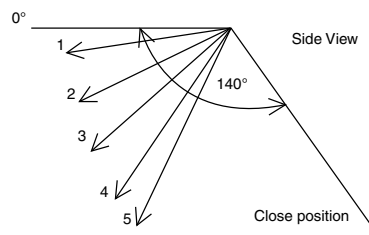

Figure 2

10.9.2 Horizontal Airflow

The horizontal airflow direction louvers can be adjusted manually by hand.

10.10 Quiet Operation (Cooling Mode/Cooling Area of Dry Mode)

- Purpose
 - To provide quiet cooling operation compare to normal operation.
- Control condition
 - Quiet operation start condition
 - When "Quiet" button at remote control is pressed.
Quiet LED illuminates.
 - Quiet operation stop condition
 - When one of the following conditions is satisfied, quiet operation stops:
 - POWERFUL/QUIET button is pressed.
 - Stop by OFF/ON button.
 - OFF Timer activates.
 - POWERFUL/QUIET button is pressed again.
 - When quiet operation is stopped, operation is shifted to normal operation with previous setting.
 - When fan speed is changed, quiet operation is shifted to quiet operation of the new fan speed.
 - When operation mode is changed, quiet operation is shifted to quiet operation of the new mode.
 - During quiet operation, if ON timer activates, quiet operation maintains.
 - After off, when on back, quiet operation is not memorised.
- Control contents
 - Auto fan speed is change from normal setting to quiet setting of respective fan speed. This is to reduce sound of Hi, Me, Lo for 3dB.
 - Manual fan speed for quiet operation is -1 step from setting fan speed.

10.11 Quiet Operation (Heating)

- Purpose
 - To provide quiet heating operation compare to normal operation.
- Control condition
 - Quiet operation start condition
 - When "POWERFUL/QUIET" button at remote control is pressed.
Quiet LED illuminates.
 - Quiet operation stop condition
 - When one of the following conditions is satisfied, quiet operation stops:
 - Stop by OFF/ON button.
 - Timer "off" activates.
 - POWERFUL/QUIET button is pressed again.
 - When quiet operation is stopped, operation is shifted to normal operation with previous setting.
 - When fan speed is changed, quiet operation is shifted to quiet operation of the new fan speed.
 - When operation mode is changed, quiet operation is shifted to quiet operation of the new mode.
 - During quiet operation, if timer "on" activates, quiet operation maintains.
 - After off, when on back, quiet operation is not memorised.
- Control contents
 - Fan speed auto
 - Indoor FM RPM depends on pipe temperature sensor of indoor heat exchanger. Auto fan speed is changed from normal setting to quiet setting of respective fan speed. This is to reduce sound of Hi, Me, Lo for 3dB.
 - Fan speed manual
 - Manual fan speed for quiet operation is -1 step from setting fan speed.

10.12 Powerful Mode Operation

- When the power mode is selected, the internal setting temperature will shift lower up to 7.2°F for Cooling/Soft Dry or higher up to 10.8°F for heating than remote control setting temperature, the powerful operation continue until user cancel the Powerful operation by pressing powerful button again.

10.13 Timer Control

10.13.1 ON Timer Control

- ON Timer can be set using remote control, where the unit with timer set will start operation earlier than the setting time. This is to provide a comfortable environment when reaching the set ON time.
- 60 minutes before the set ON time, indoor (at fan speed of Lo-) and outdoor fan motor start operation for 30 seconds to determine the indoor intake air temperature and outdoor air temperature in order to judge the operation starting time.
- From the above judgment, the decided operation will start operation earlier than the set time as shown below.

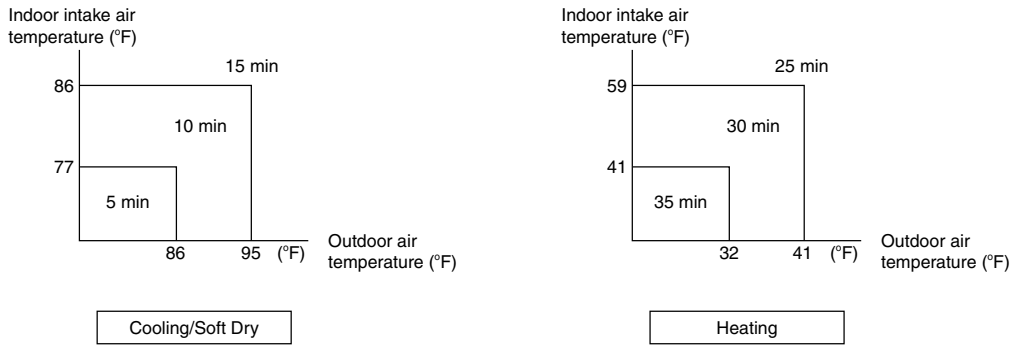

10.13.2 OFF Timer Control

- OFF Timer can be set using remote control, the unit with timer set will stop at set time.

10.14 Auto Restart Control

- When the power supply is cut off during the operation of air conditioner, the compressor will re-operate between three to four minutes (10 patterns to be selected randomly) after power resume.
- During multi split connection, Indoor unit will resume previous mode, include unit standby mode.

10.15 Indication Panel

LED	POWER	TIMER	QUIET	POWERFUL	AUTO COMFORT	ECONAVI
Color	Green	Orange	Orange	Orange	Green	Green
Light ON	Operation ON	Timer Setting ON	Quiet Mode ON	Powerful Mode ON	Auto Comfort ON	Econavi Mode ON
Light OFF	Operation OFF	Timer Setting OFF	Quiet Mode OFF	Powerful Mode OFF	Auto Comfort OFF	Econavi Mode OFF

Note:

- If POWER LED is blinking (0.5 second ON, 0.5 second OFF), the possible operation of the unit are during Indoor Residual Heat Removal, Hot Start, during Deice operation, operation mode judgment, or ON timer sampling.
- If POWER LED is blinking (2.5 seconds ON, 0.5 second OFF), the unit is in standby mode.
- If TIMER LED is blinking, there is an abnormality operation occurs.

10.16 ECONAVI and AUTO COMFORT Operation

- A Pyoelectric infrared sensor is used to detect injection strength variation of infrared at setting area to determine the presence or absence of human and its activity level. Human detection area is shown in figure below:

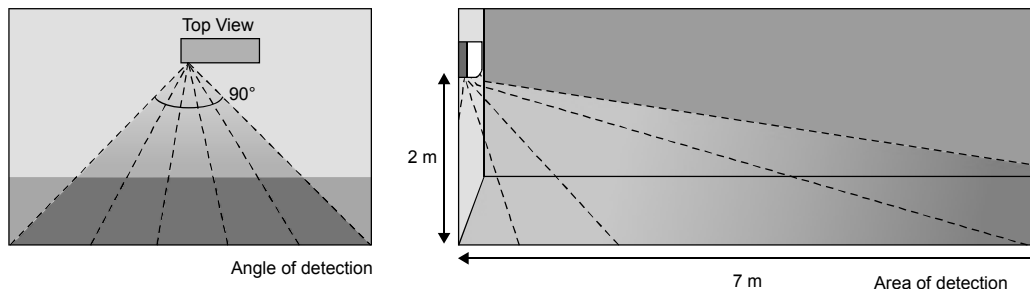

- ECONAVI and AUTO COMFORT operation – Human presence/absence detection outlined flow
 - Process infrared sensor output signal
 - Human detection (movement) every 3 seconds.
 - ▼
 - Human detection records
 - Records human detection (movement) result for 30 seconds and determine its activity level i.e. Hi/Lo.
 - ▼
 - Presence / absence detection
 - Compares current and previous human detection result every 30 seconds to determine the presence or absence of human.
 - ▼
 - Presence / absence determination
 - Based on human presence / absence detection, if human presence detection showed within 30 minutes, it is recognised that human is present. If human absence detection showed continuously for more than 30 minutes, it is recognised that no human is present.
- ECONAVI and AUTO COMFORT Sensor abnormality detection
 - Connector pulled out (disconnected), Wire cut Abnormality (Fix Output at Hi)
 - Abnormal judgment start condition.
 - Start from ECONAVI and AUTO COMFORT Sensor power ON, and end after 30 seconds.
 - Control content.
 - Judge ECONAVI and AUTO COMFORT Sensor power level every 100ms.
 - Abnormal Judgment condition.
 - When ECONAVI and AUTO COMFORT Sensor has continues for 25 seconds Hi level.
 - Circuit Abnormal (Fix Output Lo)
 - Abnormal judgment start condition.
 - After ECONAVI and AUTO COMFORT Sensor unit power ON, and after pressed 70 seconds.
 - Control content.
 - Judge ECONAVI and AUTO COMFORT Sensor power level every 100ms.
 - Abnormal Judgment condition.
 - When ECONAVI and AUTO COMFORT Sensor has continues at Lo level for 25 seconds.
 - Abnormal treatment
 - Any one of the above self-diagnosis result is abnormal
 - Abnormal counter +1 and ECONAVI and AUTO COMFORT Sensor power supply OFF.
 - After ECONAVI and AUTO COMFORT Sensor unit power is OFF for 5 seconds, Retry the ECONAVI and AUTO COMFORT operation.
 - When Abnormal counter reach 4 counts, ECONAVI and AUTO COMFORT sensor abnormality is confirmed.
 - (Abnormal counter is cleared when sensor power ON and maintain normal for 120 seconds and above or Clear Abnormal counter by power reset)
 - Save ECONAVI and AUTO COMFORT Sensor Abnormality H59 (no Timer LED blinking).
 - ECONAVI & AUTO COMFORT Sensor operation OFF, but ECONAVI and AUTO COMFORT LED maintain ON.
 - The unit still operate as normal.
 - Sensor error counter can be cleared only after power supply reset or AC Reset button on the remote control is pressed.

- ECONAVI and AUTO COMFORT Demo Mode
 - To enable ECO DEMO mode, during unit is OFF (power standby):

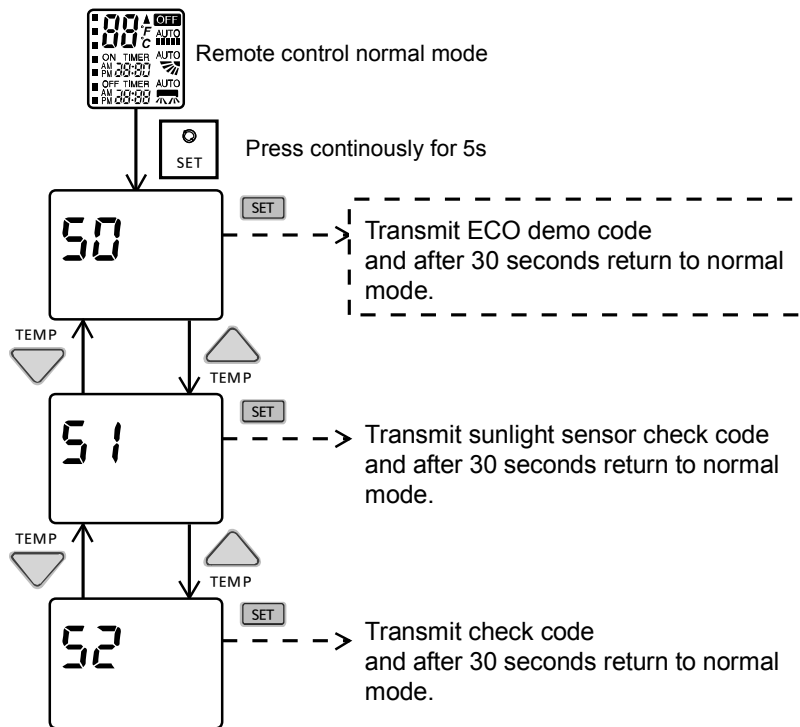

- To disable ECO Demo MODE:
 - Transmit ECO Demo signal again.

Control details:

- During ECONAVI and AUTO COMFORT Demo mode, operation LED ON and horizontal vane will set to Auto Swing.
- When Hi activity judge, Fan speed change to Hi Fan and ECONAVI and AUTO COMFORT LED ON.
- When Lo activity judge, Fan speed change to Lo Fan and ECONAVI and AUTO COMFORT LED OFF.
- No setting temperature adjustment.
- During ECONAVI and AUTO COMFORT operation, the internal setting temperature and fan speed are adjusted in order to provide comfort and energy saving.
- ECONAVI Start condition.
 - Press ECONAVI button.
- ECONAVI Stop condition.
 - Press ECONAVI button again.
 - OFF Timer activates.
 - Press OFF/ON button to turn off the air conditioner.
 - Press AUTO OFF/ON button to turn off the air conditioner.
 - Press POWERFUL/QUIET button.
- AUTO COMFORT Start condition.
 - Press AUTO COMFORT button.
- AUTO COMFORT Stop condition.
 - Press AUTO COMFORT button again.
 - OFF Timer activates.
 - Press OFF/ON button to turn off the air conditioner.
 - Press AUTO OFF/ON button to turn off the air conditioner.
 - Press POWERFUL/QUIET button.
- ECONAVI and AUTO COMFORT operation could ON when any of the following conditions is fulfilled:
 - During forced cooling or forced heating operation.
- Power Failure
 - ECONAVI and AUTO COMFORT operation will be resuming after recovered from power failure.

- Timer Operation
 - When unit is turn on by ON Timer and ECONAVI and AUTO COMFORT operation is ON during previous operation before OFF, ECONAVI and AUTO COMFORT operation will not be ON automatically.
 - When unit is turn on by ON Timer and ECONAVI and AUTO COMFORT operation is OFF during previous operation before OFF, ECONAVI and AUTO COMFORT operation will not be ON automatically.
- Other Information
 - ECONAVI and AUTO COMFORT, Powerful, Quiet and Mild Dry Cooling cannot be operated at the same time.
 - ECONAVI and AUTO COMFORT sensor initialized time is 70 seconds from power supplied to ECONAVI and AUTO COMFORT sensor, or 70 seconds from the operation start.
- Setting Temperature and Fan Speed Shift
 - Mono Sensor

ECONAVI ; Detecting human presence and activity, the unit controls room temperature to save energy.

Mode	Human	Low activity	Normal activity	High activity	Absent
COOL/DRY	Set temperature	+2°F / +1°C			+4°F / +2°C
HEAT				-4°F / -2°C	-4°F / -2°C

AUTO COMFORT ; Detecting human presence and activity, the unit controls room temperature to keep human comfortable consistently.

Mode	Human	Low activity	Normal activity	High activity	Absent
COOL/DRY	Set temperature	+2°F / +1°C +0.5°F / +0.3°C			+4°F / +2°C
HEAT	Set Fan Speed	+1 tap*		+1 tap	≤Medium Fan**

* During low activity, fan speed 1 tap up for first 15 minutes or until set temperature is reached.

** During human absence, maximum fan speed for COOL/DRY mode is medium fan.

10.16.1 Human Activity Sensor Check Mode

- To enable Human Activity sensor abnormality check mode, during ECONAVI operation ON:

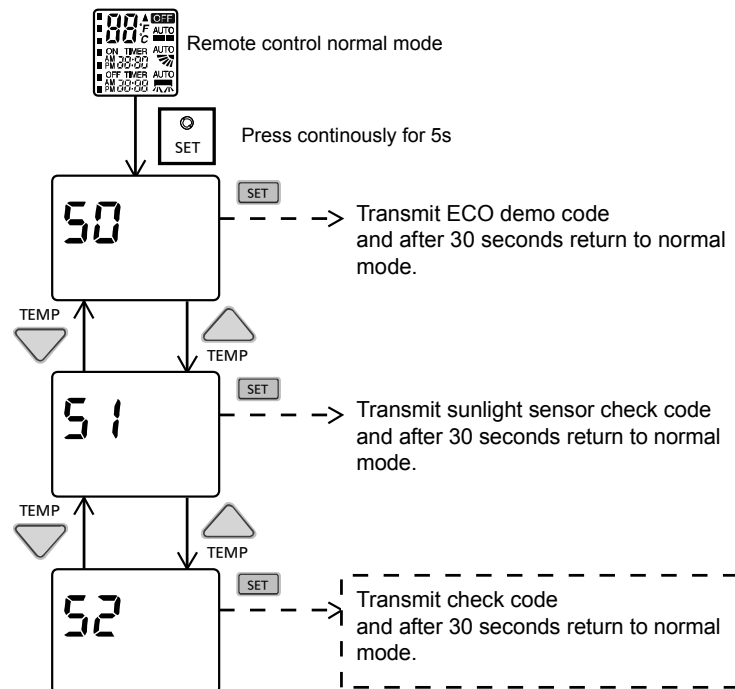

- During ECONAVI is ON, when CHECK signal received, if either sensors has abnormality, the 4 times abnormality counter is ignored, ECONAVI Indicator will blink immediately and error code is memorized.
- The unit could operate without ECONAVI or AUTO COMFORT.
- The ECONAVI indicator blinking could be cancelled by pressing ECONAVI button again.
- If the human activity sensor has no abnormality, the CHECK process will end and continue with normal operation.

11. Servicing Mode

11.1 Auto Off/On Button

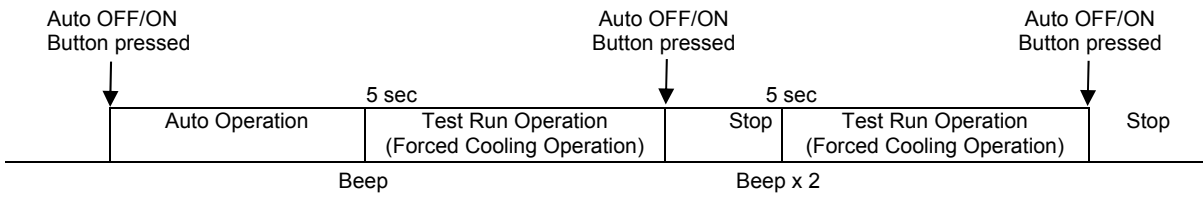

1 AUTO OPERATION MODE

The Auto operation will be activated immediately once the Auto OFF/ON button is pressed. This operation can be used to operate air conditioner with limited function if remote control is misplaced or malfunction.

2 TEST RUN OPERATION (FOR PUMP DOWN/SERVICING PURPOSE)

The Test Run operation will be activated if the Auto OFF/ON button is pressed continuously for more than 5 seconds. A “beep” sound will heard at the fifth seconds, in order to identify the starting of Test Run operation (Forced cooling operation). Within 5 minutes after Forced cooling operation start, the Auto OFF/ON button is pressed for more than 5 seconds. A 2 “beep” sounds will heard at the fifth seconds, in order to identify the starting of Forced heating operation.

The Auto OFF/ON button may be used together with remote control to set / change the advance setting of air conditioner operation.

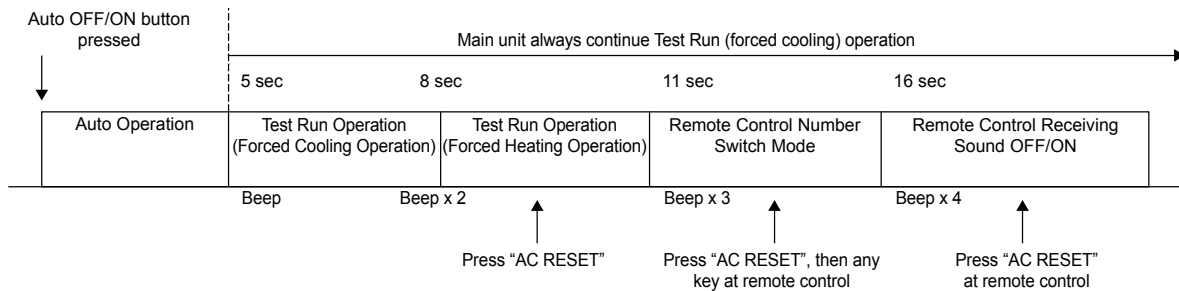

3 REMOTE CONTROL NUMBER SWITCH MODE

The Remote Control Number Switch Mode will be activated if the Auto OFF/ON button is pressed continuously for more than 11 seconds (3 “beep” sounds will occur at 11th seconds to identify the Remote Control Number Switch Mode is in standby condition) and press “AC RESET” button and then press any button at remote control to transmit and store the desired transmission code to the EEPROM.

There are 4 types of remote control transmission code could be selected and stored in EEPROM of indoor unit. The indoor unit will only operate when received signal with same transmission code from remote control. This could prevent signal interference when there are 2 or more indoor units installed nearby together. To change remote control transmission code, short or open jumpers at the remote control printed circuit board.

Remote Control Printed Circuit Board		
Jumper A (J1)	Jumper B (D2)	Remote Control No.
Short	Open	A (Default)
Open	Open	B
Short	Short	C
Open	Short	D

- During Remote Control Number Switch Mode, press any button at remote control to transmit and store the transmission code to the EEPROM.

4 REMOTE CONTROL RECEIVING SOUND OFF/ON MODE

The Remote Control Receiving Sound OFF/ON Mode will be activated if the Auto OFF/ON button is pressed continuously for more than 16 seconds (4 “beep” sounds will occur at 16th seconds to identify the Remote Control Receiving Sound OFF/ON Mode is in standby condition) and press “AC Reset” button at remote control.

Press Auto OFF/ON button to toggle remote control receiving sound.

- Short “beep”: Turn OFF remote control receiving sound.
- Long “beep”: Turn ON remote control receiving sound.

After Auto OFF/ON button is pressed, the 20 seconds counter for Remote Control Receiving Sound OFF/ON Mode is restarted.

11.2 Remote Control Button

11.2.1 SET Button

- To check remote control transmission code and store the transmission code to EEPROM
 - Press “Set” button continuously for 10 seconds by using pointer
 - Press “Timer Set” button until a “beep” sound is heard as confirmation of transmission code change.

11.2.2 RESET (RC)

- To clear and restore the remote control setting to factory default.
 - Press once to clear the memory

11.2.3 RESET (AC)

- To restore the unit’s setting to factory default.
 - Press once to restore the unit’s setting

11.2.4 TIMER ▲

- To change indoor unit indicator’s LED intensity:
 - Press continuously for 5 seconds.

11.2.5 TIMER ▼

- To change remote control display from Degree Celsius (°C) to Degree Fahrenheit (°F)
 - Press continuously for 10 seconds.

11.2.6 CLOCK Button

- To change the remote control time format:
 - Press for more than 5 seconds

12. Troubleshooting Guide

12.1 Refrigeration Cycle System

In order to diagnose malfunctions, make sure that there are no electrical problems before inspecting the refrigeration cycle. Such problems include insufficient insulation, problem with the power source, malfunction of a compressor and a fan. The normal outlet air temperature and pressure of the refrigeration cycle depends on various conditions, the standard values for them are shown in the table on the right.

Normal Pressure and Outlet Air Temperature (Standard)

	Gas Pressure PSI (kg/cm ² G)	Outlet air Temperature (°F)
Cooling Mode	130.53 ~ 174.04 (9 ~ 12)	53.6 ~ 60.8
Heating Mode	333.58 ~ 420.60 (23 ~ 29)	96.8 ~ 113

Condition: Indoor fan speed = High
 Outdoor temperature 95°F at cooling mode
 and 44.6°F at heating mode.
 Compressor operate at rated frequency

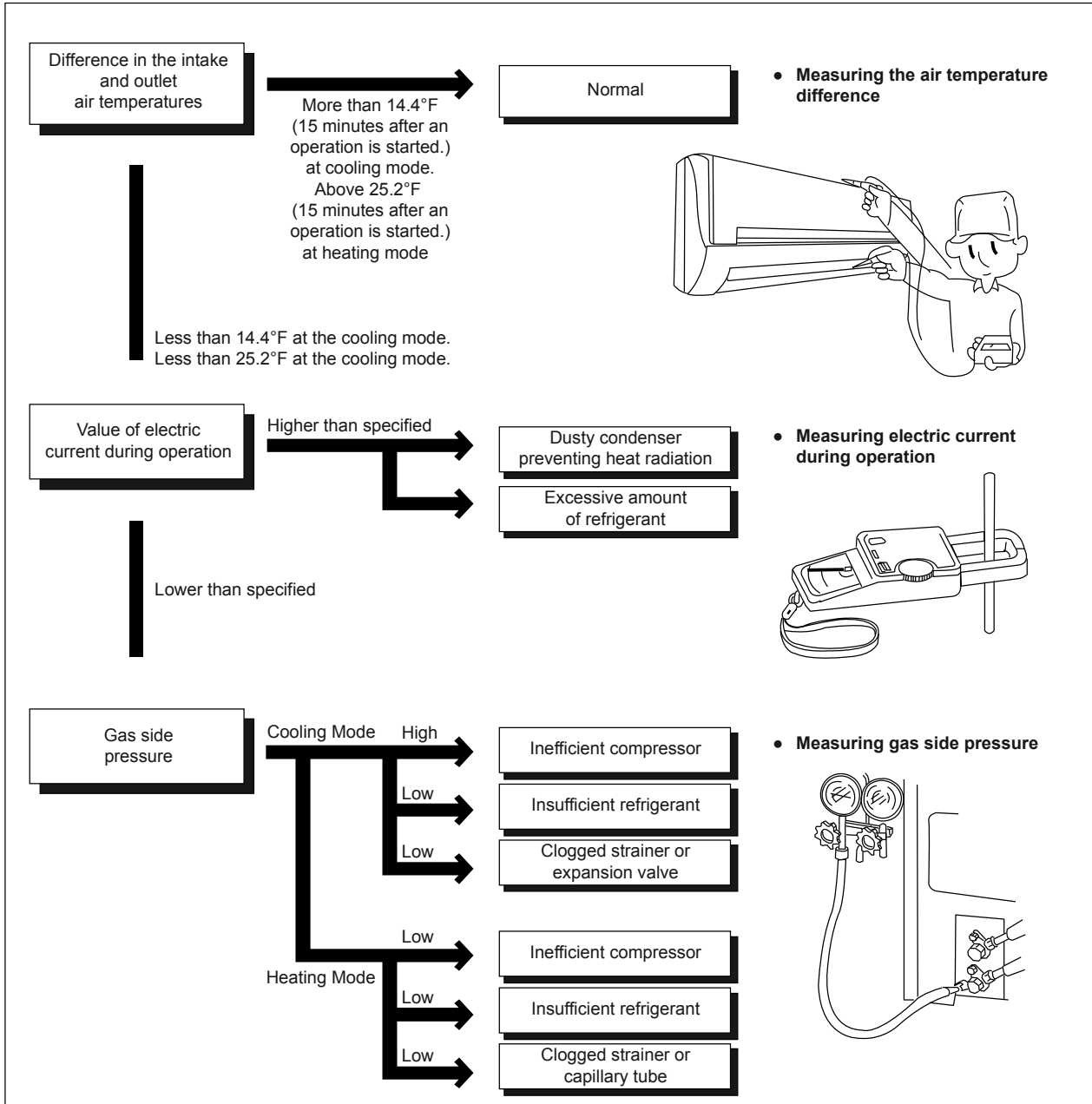

12.1.1 Relationship between the condition of the air conditioner and pressure and electric current

Condition of the air conditioner	Cooling Mode			Heating Mode		
	Low Pressure	High Pressure	Electric current during operating	Low Pressure	High Pressure	Electric current during operating
Insufficient refrigerant (gas leakage)	↘	↘	↘	↘	↘	↘
Clogged capillary tube or Strainer	↘	↘	↘	↗	↗	↗
Short circuit in the indoor unit	↘	↘	↘	↗	↗	↗
Heat radiation deficiency of the outdoor unit	↗	↗	↗	↘	↘	↘
Inefficient compression	↗	↘	↘	↗	↘	↘

- Carry out the measurements of pressure, electric current, and temperature fifteen minutes after an operation is started.

12.2 Breakdown Self Diagnosis Function

12.2.1 Self Diagnosis Function (Three Digits Alphanumeric Code)

- Once error occurred during operation, the unit will stop its operation, and Timer LED blinks.
- Although Timer LED goes off when power supply is turned off, if the unit is operated under a breakdown condition, the LED will ON again.
- In operation after breakdown repair, the Timer LED will not blink. The last error code (abnormality) will be stored in IC memory.

12.2.2 To Make a Diagnosis

- 1 Timer LED starts to blink and the unit automatically stops the operation.
- 2 Press the CHECK button on the remote control continuously for 5 seconds.
- 3 “- -” will be displayed on the remote control display.
Note: Display only for “- -” (No signal transmission, no receiving sound and no Power LED blinking)
- 4 Press the TIMER ▲ or ▼ button on the remote control. The code “H00” (no abnormality) will be displayed and signal will be transmit to the main unit.
- 5 Each press of the button (▲ or ▼) will increase error code number and transmit error code signal to the main unit.
- 6 When the latest abnormality code on the main unit and code transmitted from the remote control are matched, Power LED will light up for 30 seconds and a “beep” sound (continuously for 4 seconds) will be heard. If no codes are matched, Power LED will light up for 0.5 seconds and no sound will be heard.
- 7 The breakdown diagnosis mode will be canceled unless pressing the CHECK button continuously for 5 seconds or operating the unit for 30 seconds.
- 8 The LED will be off if the unit is turned off or the RESET button on the main unit is pressed.



12.2.3 To Display Memorized Error Code (Protective Operation)

- 1 Turn power on.
- 2 Press the CHECK button on the remote control
- 3 “- -” will be displayed on the remote control display.
Note: Display only for “- -” (No signal transmission, no receiving sound and no Power LED blinking)
- 4 Press the TIMER ▲ or ▼ button on the remote control. The code “H00” (no abnormality) will be displayed and signal will be transmit to the main unit.
- 5 Each press of the button (▲ or ▼) will increase error code number and transmit error code signal to the main unit.
- 6 When the latest abnormality code on the main unit and code transmitted from the remote control are matched, Power LED will light up for 30 seconds and a “beep” sound (continuously for 4 seconds) will be heard. If no codes are matched, Power LED will light up for 0.5 seconds and no sound will be heard.
- 7 The breakdown diagnosis mode will be canceled unless pressing the CHECK button continuously for 5 seconds or operating the unit for 30 seconds.
- 8 The same diagnosis can be repeated by turning power on again.

12.2.4 To Clear Memorized Error Code after Repair (Protective Operation)

- 1 Turn power on (in standby condition).
- 2 Press the AUTO button for 5 seconds (a “beep” sound is heard) on the main unit to operate the unit at Forced Cooling Operation Mode.
- 3 Press the CHECK button on the remote control for about 1 second with a pointed object to transmit signal to main unit. A “beep” sound is heard, and the Error Code is cleared.

12.2.5 Temporary Operation (Depending On Breakdown Status)

- 1 Press the Auto OFF/ON button on the main unit (a “beep” sound is heard) to operate the unit. (Remote control is enable again).
- 2 The unit can be temporarily be used until repaired.

Error Code	Operation	Temporary items
H23	Cooling	Emergency Operation with limited power
H27, H28	Cooling, Heating	

12.3 Error Code Table

Diagnosis display	Abnormality / Protection control	Abnormality Judgement	Protection operation	Problem	Check location
H00	No memory of failure	—	Normal operation	—	—
H11	Indoor/outdoor abnormal communication	After operation for 1 minute	Indoor fan only operation can start by entering into force cooling operation	Indoor/outdoor communication not establish	<ul style="list-style-type: none"> Indoor/outdoor wire terminal Indoor/outdoor PCB Indoor/outdoor connection wire
H12	Indoor unit capacity unmatched	90s after power supply	—	Total indoor capability more than maximum limit or less than minimum limit, or number of indoor unit less than two.	<ul style="list-style-type: none"> Indoor/outdoor connection wire Indoor/outdoor PCB Specification and combination table in catalogue
H14	Indoor intake air temperature sensor abnormality	Continuous for 5s	—	Indoor intake air temperature sensor open or short circuit	<ul style="list-style-type: none"> Indoor intake air temperature sensor lead wire and connector
H15	Compressor temperature sensor abnormality	Continuous for 5s	—	Compressor temperature sensor open or short circuit	<ul style="list-style-type: none"> Compressor temperature sensor lead wire and connector
H16	Outdoor current transformer (CT) abnormality	—	—	Current transformer faulty or compressor faulty	<ul style="list-style-type: none"> Outdoor PCB faulty or compressor faulty
H19	Indoor fan motor mechanism lock	Continuous happen for 7 times	—	Indoor fan motor lock or feedback abnormal	<ul style="list-style-type: none"> Fan motor lead wire and connector Fan motor lock or block
H23	Indoor heat exchanger temperature sensor abnormality	Continuous for 5s	—	Indoor heat exchanger temperature sensor open or short circuit	<ul style="list-style-type: none"> Indoor heat exchanger temperature sensor lead wire and connector
H24	Indoor heat exchanger temperature sensor 2 abnormality	Continuous for 5s	—	Indoor heat exchanger temperature sensor 2 open or short circuit	<ul style="list-style-type: none"> Indoor heat exchanger temperature sensor 2 lead wire and connector
H25	Indoor ion device abnormality	Port is ON for 10s during ion device off	—	—	<ul style="list-style-type: none"> ion device PCB
H27	Outdoor air temperature sensor abnormality	Continuous for 5s	—	Outdoor air temperature sensor open or short circuit	<ul style="list-style-type: none"> Outdoor air temperature sensor lead wire and connector
H28	Outdoor heat exchanger temperature sensor 1 abnormality	Continuous for 5s	—	Outdoor heat exchanger temperature sensor 1 open or short circuit	<ul style="list-style-type: none"> Outdoor heat exchanger temperature sensor 1 lead wire and connector
H30	Outdoor discharge pipe temperature sensor abnormality	Continuous for 5s	—	Outdoor discharge pipe temperature sensor open or short circuit	<ul style="list-style-type: none"> Outdoor discharge pipe temperature sensor lead wire and connector
H32	Outdoor heat exchanger temperature sensor 2 abnormality	Continuous for 5s	—	Outdoor heat exchanger temperature sensor 2 open or short circuit	<ul style="list-style-type: none"> Outdoor heat exchanger temperature sensor 2 lead wire and connector
H33	Indoor / outdoor misconnection abnormality	—	—	Indoor and outdoor rated voltage different	<ul style="list-style-type: none"> Indoor and outdoor units check
H34	Outdoor heat sink temperature sensor abnormality	Continuous for 2s	—	Outdoor heat sink temperature sensor open or short circuit	<ul style="list-style-type: none"> Outdoor heat sink sensor
H36	Outdoor gas pipe temperature sensor abnormality	Continuous for 5s	Heating protection operation only	Outdoor gas pipe temperature sensor open or short circuit	<ul style="list-style-type: none"> Outdoor gas pipe temperature sensor lead wire and connector
H37	Outdoor liquid pipe temperature sensor abnormality	Continuous for 5s	Cooling protection operation only	Outdoor liquid pipe temperature sensor open or short circuit	<ul style="list-style-type: none"> Outdoor liquid pipe temperature sensor lead wire and connector
H38	Indoor/Outdoor mismatch (brand code)	—	—	Brand code not match	<ul style="list-style-type: none"> Check indoor unit and outdoor unit.

Diagnosis display	Abnormality / Protection control	Abnormality Judgement	Protection operation	Problem	Check location
H39	Abnormal indoor operating unit or standby units	3 times happen within 40 minutes	—	Wrong wiring and connecting pipe, expansion valve abnormality, indoor heat exchanger sensor open circuit	<ul style="list-style-type: none"> • Check the indoor/outdoor connection wire and connection pipe. • Indoor heat exchanger sensor lead wire and connector. • Expansion valve and lead wire and connector system.
H41	Abnormal wiring or piping connection	—	—	Wrong wiring and connecting pipe, expansion valve abnormality	<ul style="list-style-type: none"> • Check indoor/outdoor connection wire and connection pipe • Expansion valve and lead wire and connector
H59	ECONAVI sensor abnormality	Continuous for 25s	—	ECOANVI sensor open or short circuit	<ul style="list-style-type: none"> • ECONAVI sensor (defective or disconnected) • ECONAVI PCB
H64	Outdoor high pressure sensor abnormality	Continuous for 1 minute	—	High pressure sensor open circuit during compressor	<ul style="list-style-type: none"> • High pressure sensor • Lead wire and connector
H97	Outdoor fan motor mechanism lock	2 times happen within 30 minutes	—	Outdoor fan motor lock or feedback abnormal	<ul style="list-style-type: none"> • Outdoor fan motor lead wire and connector • Fan motor lock or block
H98	Indoor high pressure protection	—	—	Indoor high pressure protection (Heating)	<ul style="list-style-type: none"> • Check indoor heat exchanger • Air filter dirty • Air circulation short circuit
H99	Indoor operating unit freeze protection	—	—	Indoor freeze protection (Cooling)	<ul style="list-style-type: none"> • Check indoor heat exchanger • Air filter dirty • Air circulation short circuit
F11	4-way valve switching abnormality	4 times happen within 30 minutes	—	4-way valve switching abnormal	<ul style="list-style-type: none"> • 4-way valve • Lead wire and connector.
F17	Indoor standby units freezing abnormality	3 times happen within 40 minutes	—	Wrong wiring and connecting pipe, expansion valve leakage, indoor heat exchanger sensor open circuit	<ul style="list-style-type: none"> • Check indoor/outdoor connection wire and pipe • Indoor heat exchanger sensor lead wire and connector • Expansion valve lead wire and connector.
F90	Power factor correction (PFC) circuit protection	4 times happen within 10 minutes	—	Power factor correction circuit abnormal	<ul style="list-style-type: none"> • Outdoor PCB faulty
F91	Refrigeration cycle abnormality	2 times happen within 20 minutes	—	Refrigeration cycle abnormal	<ul style="list-style-type: none"> • Insufficient refrigerant or valve close
F93	Compressor abnormal revolution	4 times happen within 20 minutes	—	Compressor abnormal revolution	<ul style="list-style-type: none"> • Power transistor module faulty or compressor lock
F94	Compressor discharge overshoot protection	4 times happen within 30 minutes	—	Compressor discharge pressure overshoot	<ul style="list-style-type: none"> • Check refrigeration system
F95	Outdoor cooling high pressure protection	4 times happen within 20 minutes	—	Cooling high pressure protection	<ul style="list-style-type: none"> • Check refrigeration system • Outdoor air circuit
F96	Power transistor module overheating protection	4 times happen within 30 minutes	—	Power transistor module overheat	<ul style="list-style-type: none"> • PCB faulty • Outdoor air circuit (fan motor)
F97	Compressor overheating protection	3 times happen within 30 minutes	—	Compressor overheat	<ul style="list-style-type: none"> • Insufficient refrigerant
F98	Total running current protection	3 times happen within 20 minutes	—	Total current protection	<ul style="list-style-type: none"> • Check refrigeration system • Power source or compressor lock
F99	Outdoor direct current (DC) peak detection	Continuous happen for 7 times	—	Power transistor module current protection	<ul style="list-style-type: none"> • Power transistor module faulty or compressor lock

Note:

“o” – Frequency measured and fan speed fixed

The memory data of error code is erased when the power supply is cut off, or press the Auto Switch until “beep” sound heard following by pressing the CHECK button at remote control.

Although operation forced to stop when abnormality detected, emergency operation is possible for certain errors (refer to Error Code Table) by using remote control or Auto OFF/ON button at indoor unit. However, the remote control signal receiving sound is changed from one “beep” to four “beep” sounds.

12.4 Self-diagnosis Method

12.4.1 H11 (Indoor/Outdoor Abnormal Communication)

Malfunction Decision Conditions

- During startup and operation of cooling and heating, the data received from outdoor unit in indoor unit signal transmission is checked whether it is normal.

Malfunction Caused

- Faulty indoor unit PCB.
- Faulty outdoor unit PCB.
- Indoor unit-outdoor unit signal transmission error due to wrong wiring.
- Indoor unit-outdoor unit signal transmission error due to breaking of wire in the connection wires between the indoor and outdoor units.
- Indoor unit-outdoor unit signal transmission error due to disturbed power supply waveform.

Troubleshooting

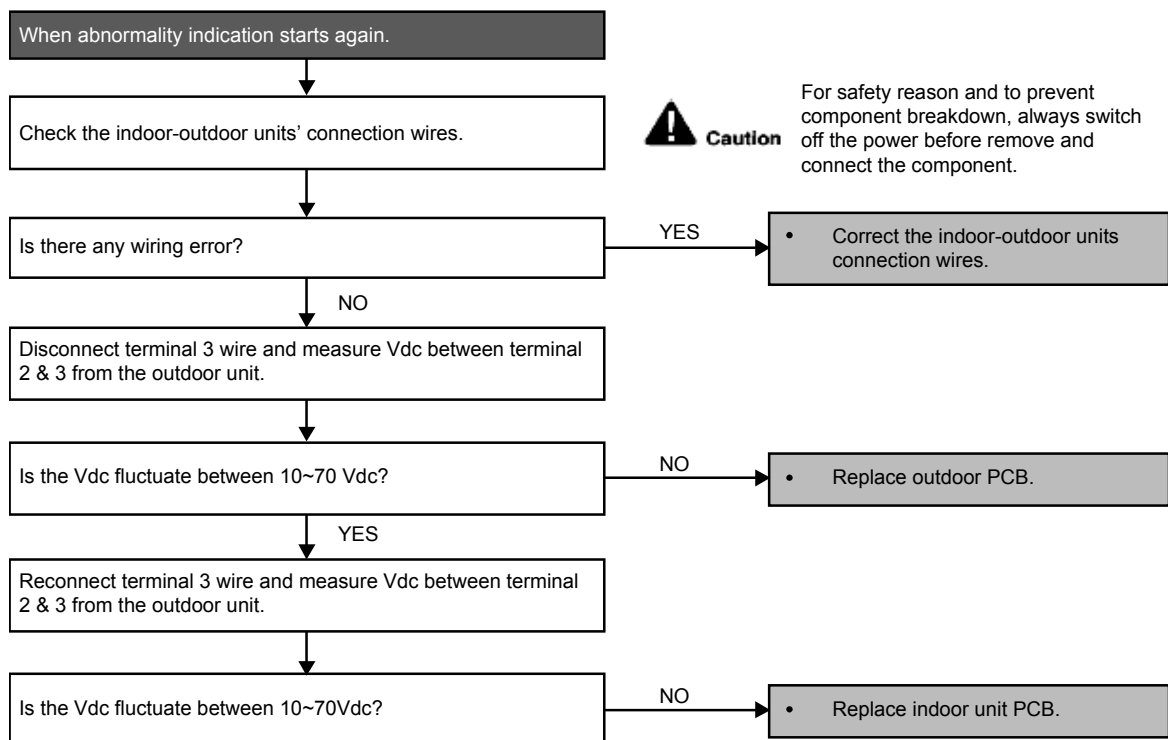

12.4.2 H12 (Indoor/Outdoor Capacity Rank Mismatched)

Malfunction Decision Conditions

- During startup, error code appears when different types of indoor and outdoor units are interconnected.

Malfunction Caused

- Wrong models interconnected.
- Wrong indoor unit or outdoor unit PCBs mounted.
- Indoor unit or outdoor unit PCBs defective.
- Indoor-outdoor unit signal transmission error due to wrong wiring.
- Indoor-outdoor unit signal transmission error due to breaking of wire 3 in the connection wires between the indoor and outdoor units.

Troubleshooting

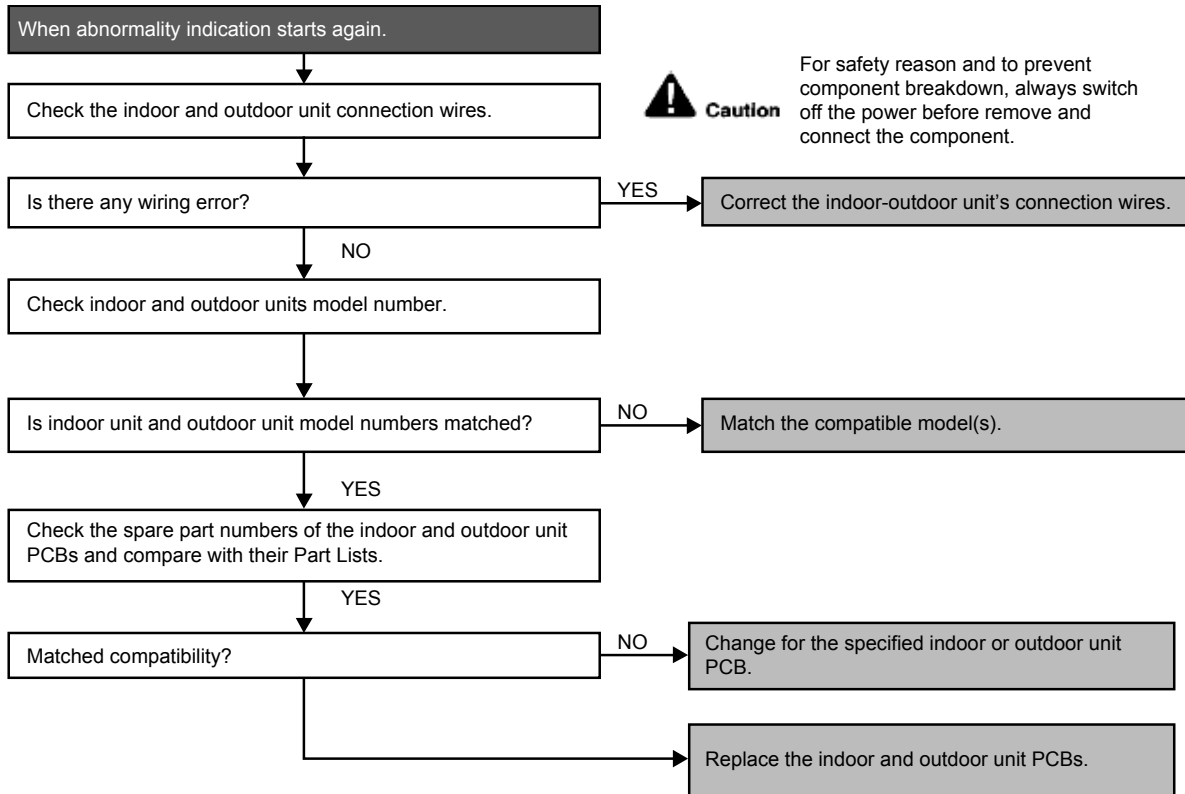

12.4.3 H14 (Indoor Intake Air Temperature Sensor Abnormality)

Malfunction Decision Conditions

- During startup and operation of cooling and heating, the temperatures detected by the indoor intake air temperature sensor are used to determine sensor errors.

Malfunction Caused

- Faulty connector connection.
- Faulty sensor.
- Faulty PCB.

Troubleshooting

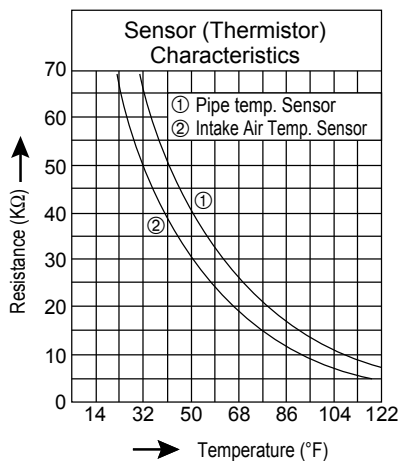
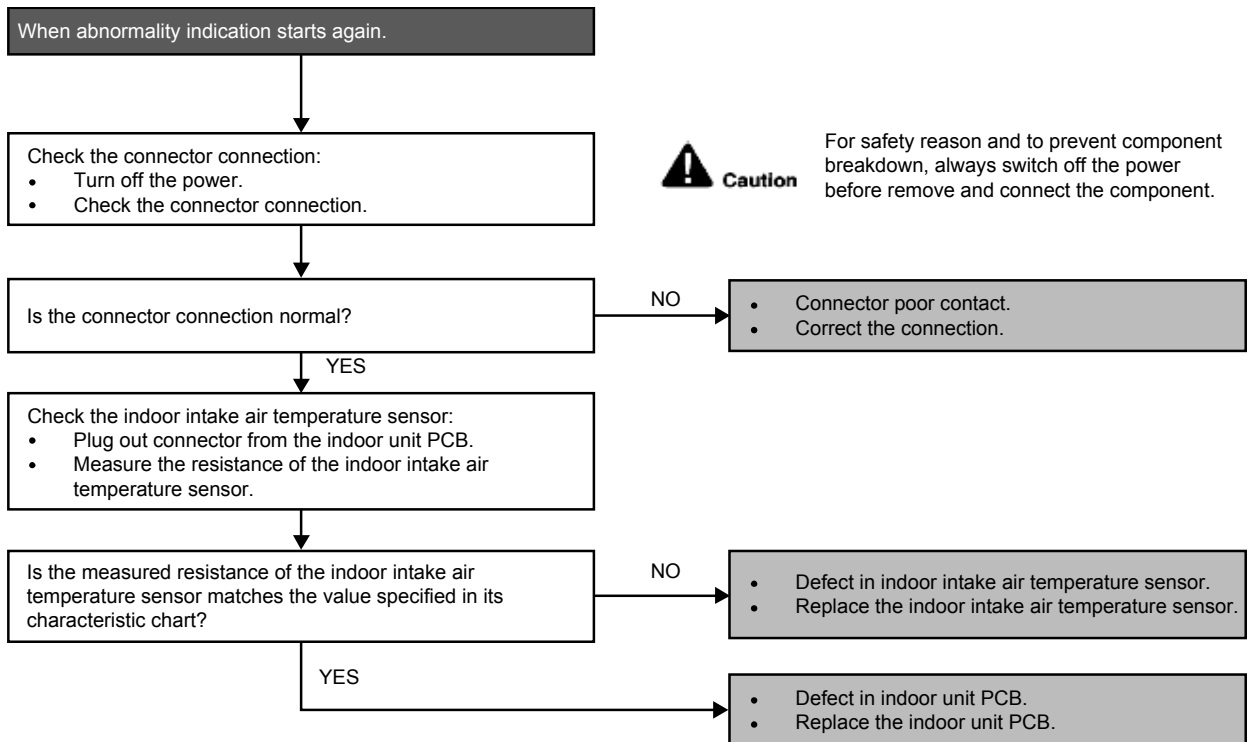

12.4.4 H15 (Compressor Temperature Sensor Abnormality)

Malfunction Decision Conditions

- During startup and operation of cooling and heating, the temperatures detected by the outdoor compressor temperature sensor are used to determine sensor errors.

Malfunction Caused

- Faulty connector connection.
- Faulty sensor.
- Faulty PCB.

Troubleshooting

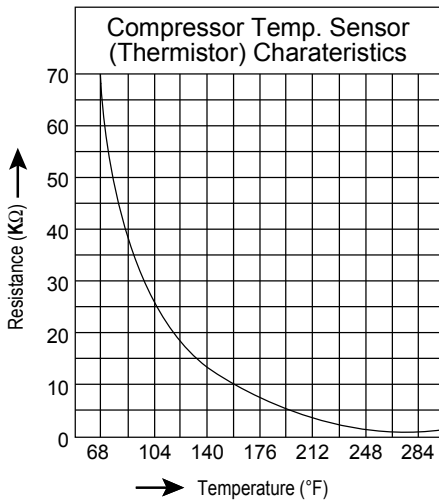
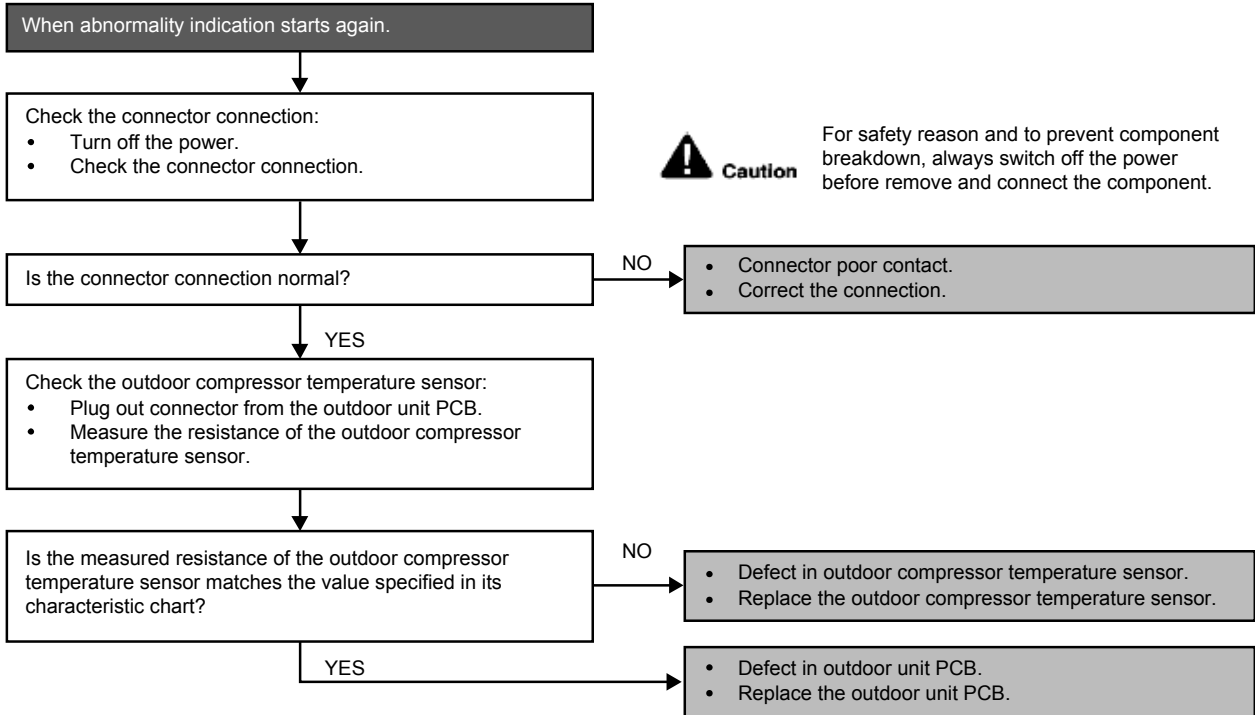

12.4.5 H16 (Outdoor Current Transformer)

Malfunction Decision Conditions

- An input current, detected by Current Transformer CT, is below threshold value when the compressor is operating at certain frequency value for 3 minutes.

Malfunction Caused

- Lack of gas.
- Broken CT (current transformer).
- Broken Outdoor PCB.

Troubleshooting

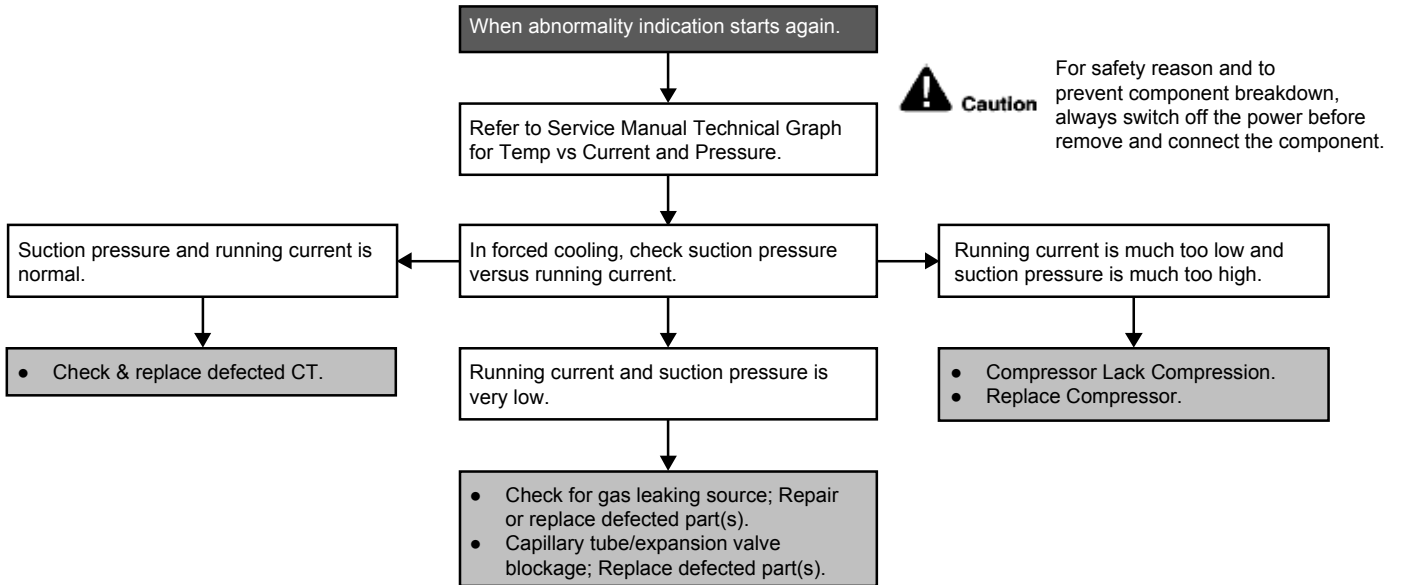

12.4.6 H19 (Indoor Fan Motor – DC Motor Mechanism Locked)

Malfunction Decision Conditions

- The rotation speed detected by the Hall IC during fan motor operation is used to determine abnormal fan motor (feedback of rotation > 2550rpm or < 50rpm)

Malfunction Caused

- Operation stops due to short circuit inside the fan motor winding.
- Operation stops due to breaking of wire inside the fan motor.
- Operation stops due to breaking of fan motor lead wires.
- Operation stops due to Hall IC malfunction.
- Operation error due to faulty indoor unit PCB.

Troubleshooting

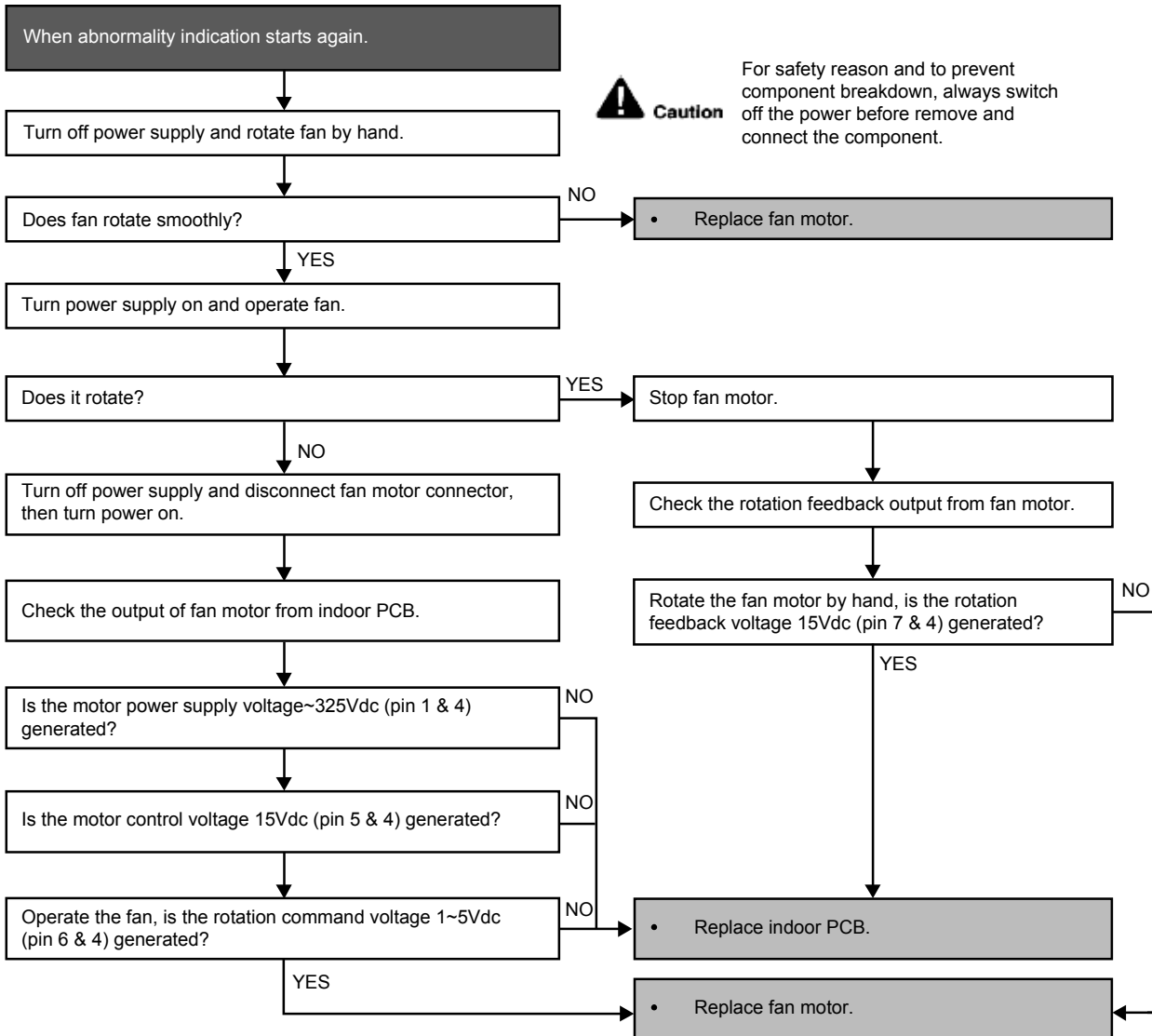

12.4.7 H23 (Indoor Pipe Temperature Sensor Abnormality)

Malfunction Decision Conditions

- During startup and operation of cooling and heating, the temperatures detected by the indoor heat exchanger temperature sensor are used to determine sensor errors.

Malfunction Caused

- Faulty connector connection.
- Faulty sensor.
- Faulty PCB.

Troubleshooting

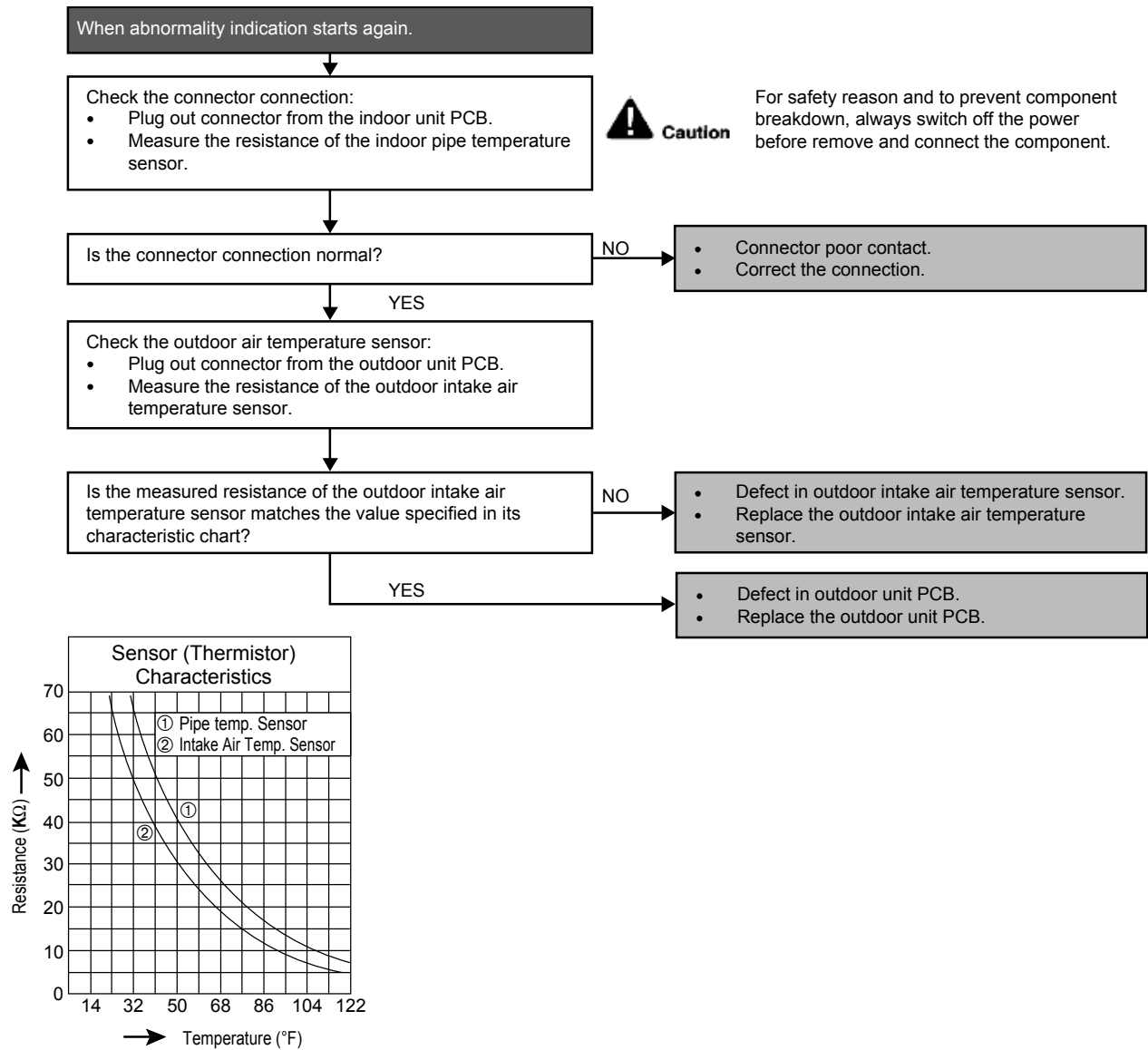

12.4.8 H27 (Outdoor Air Temperature Sensor Abnormality)

Malfunction Decision Conditions

- During startup and operation of cooling and heating, the temperatures detected by the outdoor air temperature sensor are used to determine sensor errors.

Malfunction Caused

- Faulty connector connection.
- Faulty sensor.
- Faulty PCB.

Troubleshooting

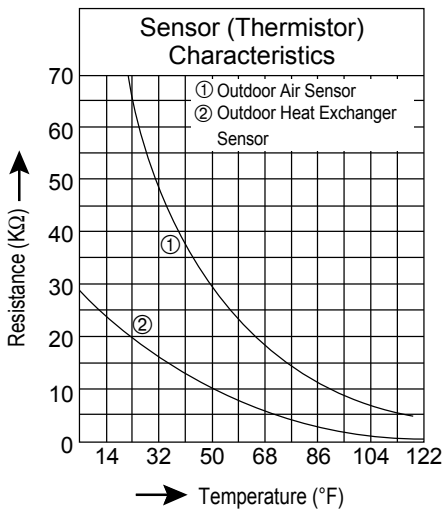
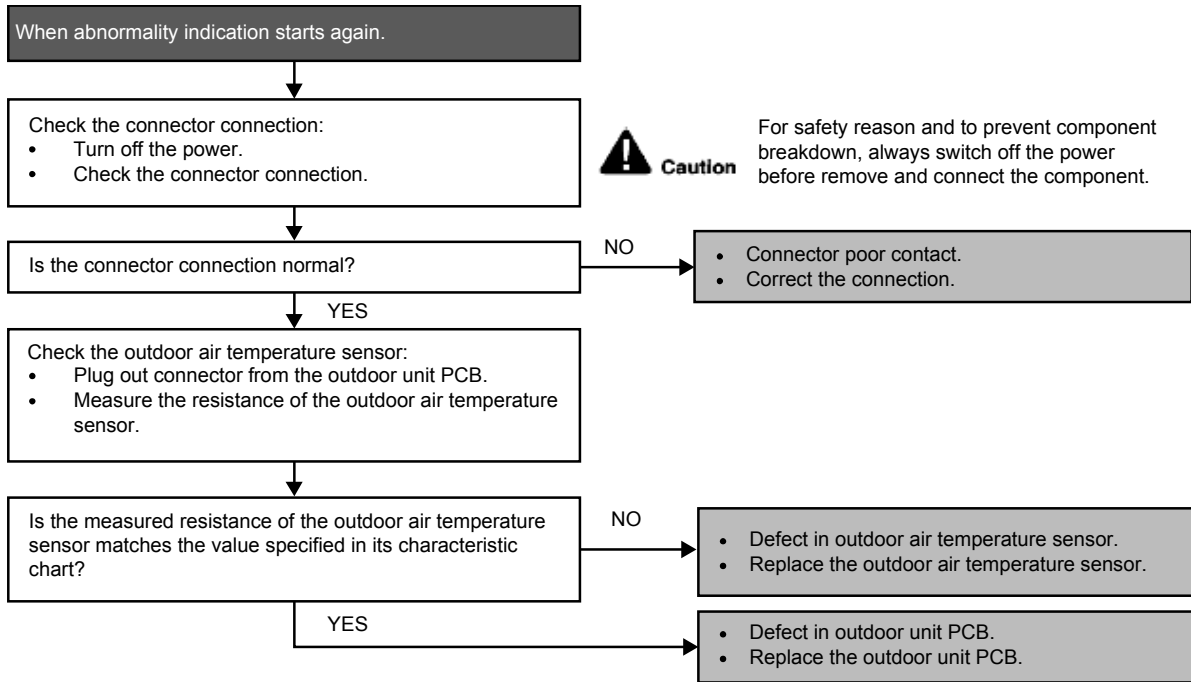

12.4.9 H28 (Outdoor Pipe Temperature Sensor Abnormality)

Malfunction Decision Conditions

- During startup and operation of cooling and heating, the temperatures detected by the outdoor pipe temperature sensor are used to determine sensor errors.

Malfunction Caused

- Faulty connector connection.
- Faulty sensor.
- Faulty PCB.

Troubleshooting

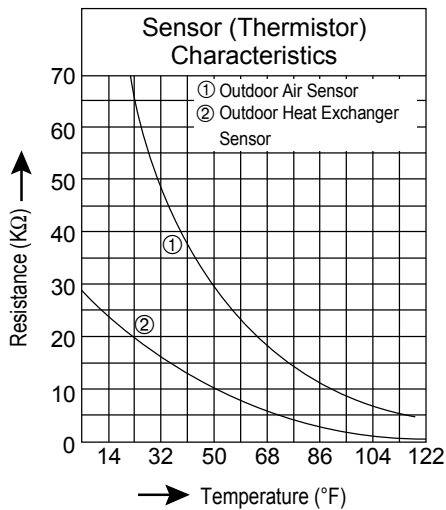
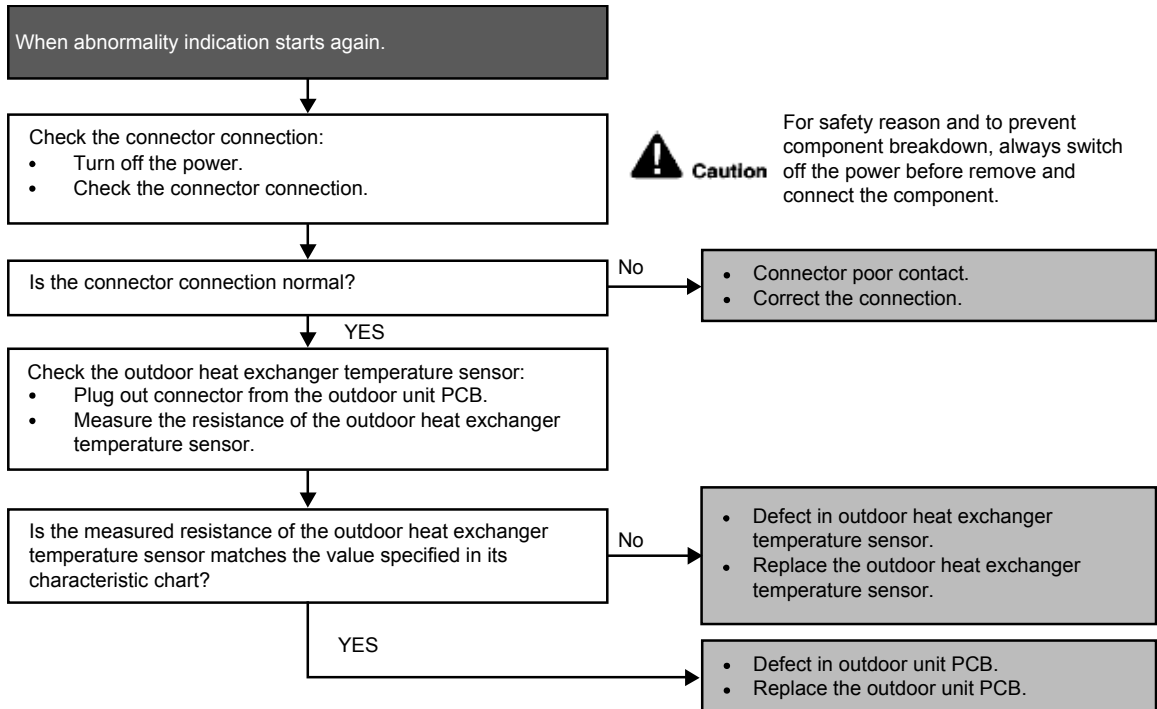

12.4.10 H30 (Compressor Discharge Temperature Sensor Abnormality)

Malfunction Decision Conditions

- During startup and operation of cooling and heating, the temperatures detected by the outdoor discharge pipe temperature sensor are used to determine sensor errors.

Malfunction Caused

- Faulty connector connection.
- Faulty sensor.
- Faulty PCB.

Troubleshooting

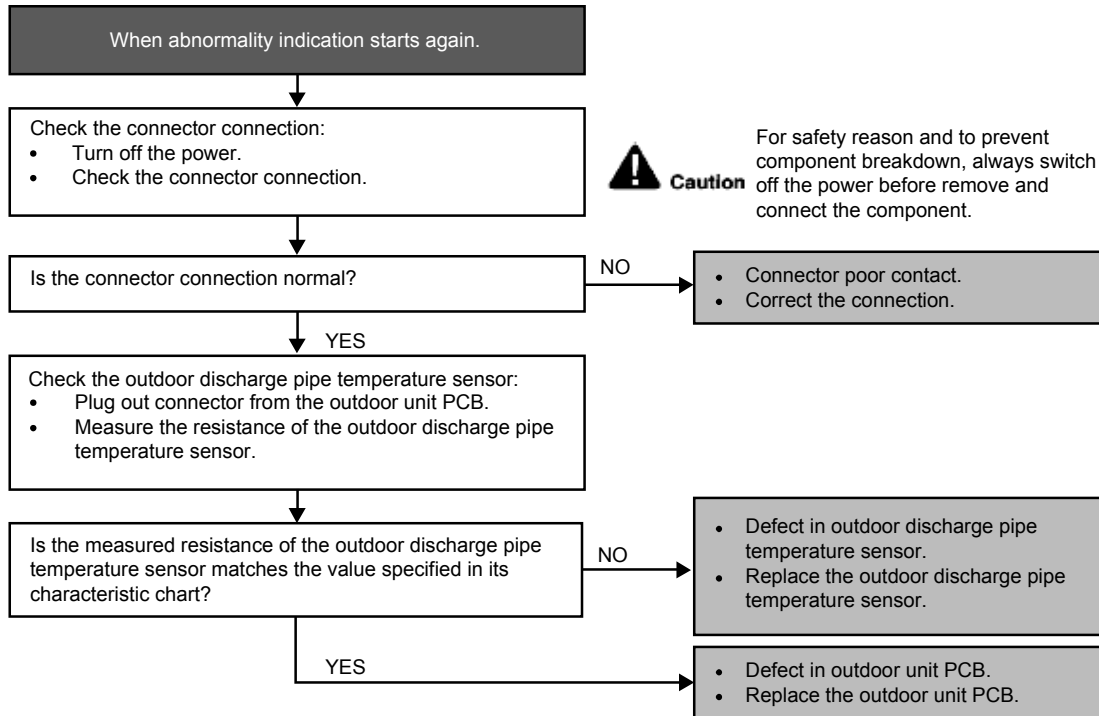

12.4.11 H32 (Outdoor Heat Exchanger Temperature Sensor 2 Abnormality)

Malfunction Decision Conditions

- During startup and operation of cooling and heating, the temperatures detected by the outdoor heat exchanger temperature sensor are used to determine sensor errors.

Malfunction Caused

- Faulty connector connection.
- Faulty sensor.
- Faulty PCB.

Troubleshooting

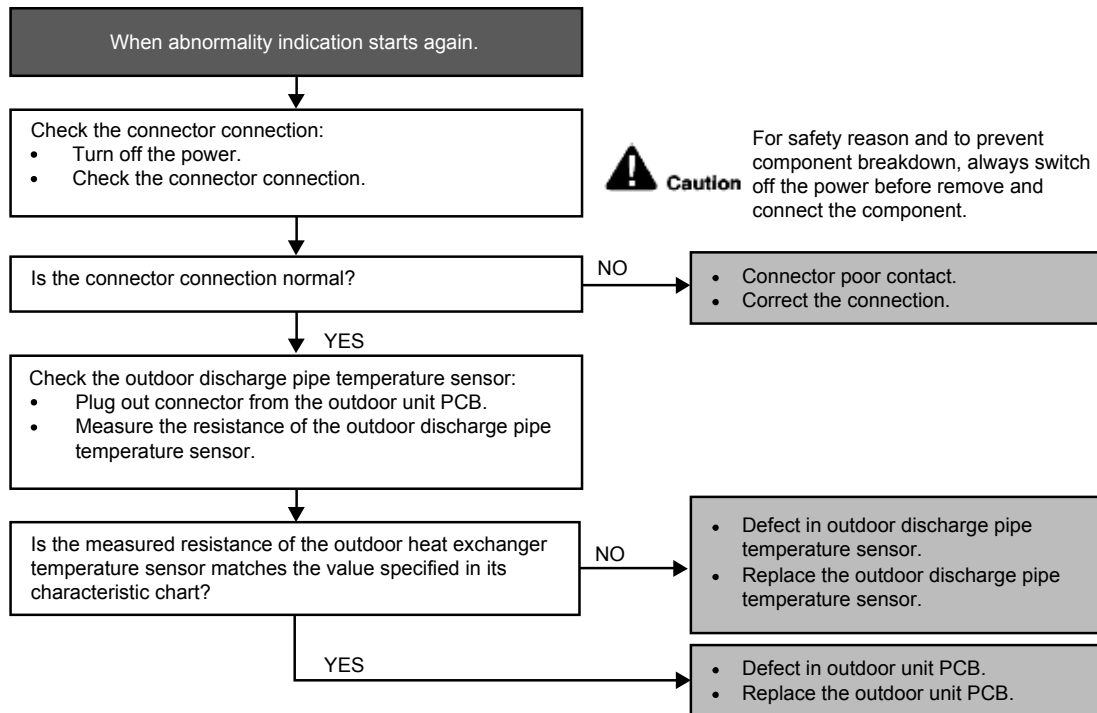

12.4.12 H33 (Unspecified Voltage between Indoor and Outdoor)

Malfunction Decision Conditions

- The supply power is detected for its requirement by the indoor/outdoor transmission.

Malfunction Caused

- Wrong models interconnected.
- Wrong indoor unit and outdoor unit PCBs used.
- Indoor unit or outdoor unit PCB defective.

Troubleshooting

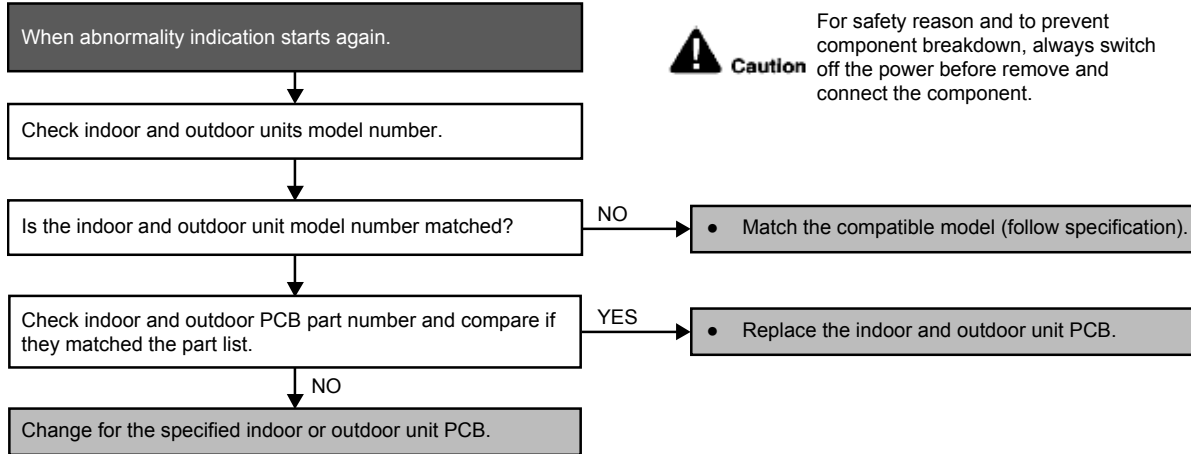

12.4.13 H34 (Outdoor Heat Sink Temperature Sensor Abnormality)

Malfunction Decision Conditions

- During startup and operation of cooling and heating, the temperatures detected by the outdoor heat sink temperature sensor are used to determine sensor errors.

Malfunction Caused

- Faulty connector connection.
- Faulty sensor.
- Faulty PCB.

Troubleshooting

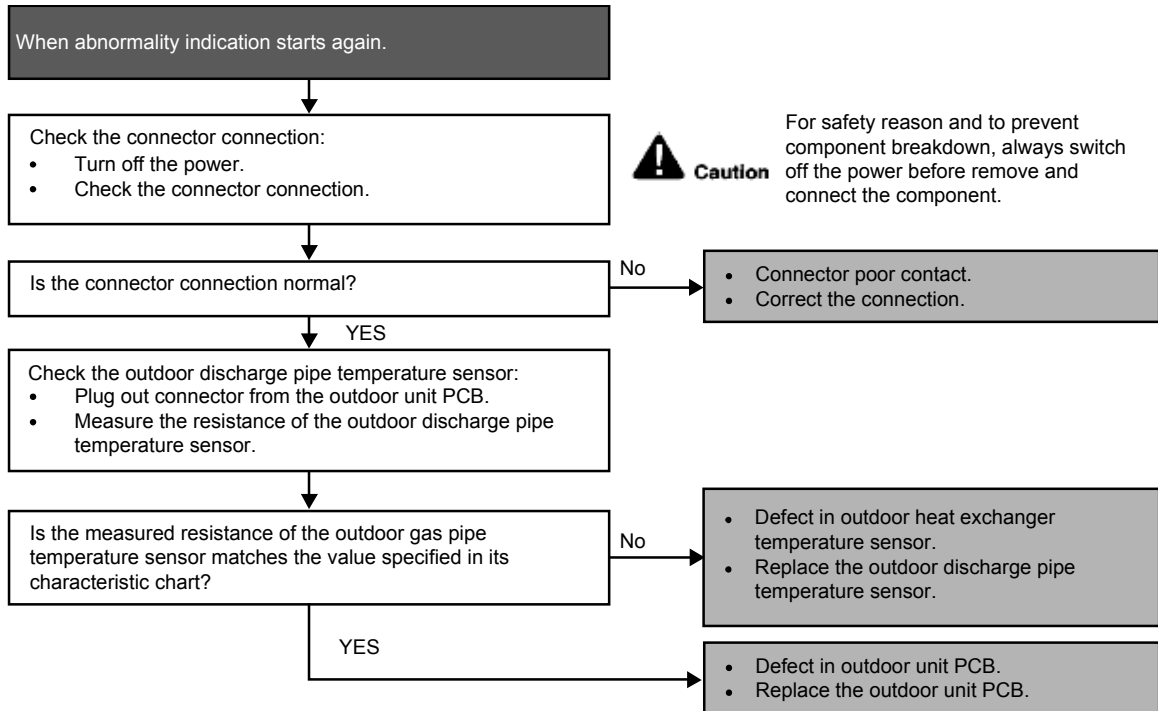

12.4.14 H36 (Outdoor Gas Pipe Sensor Abnormality)

Malfunction Decision Conditions

- During startup and operation of cooling and heating, the temperatures detected by the outdoor gas pipe temperature sensor are used to determine sensor errors.

Malfunction Caused

- Faulty connector connection.
- Faulty sensor.
- Faulty PCB.

Troubleshooting

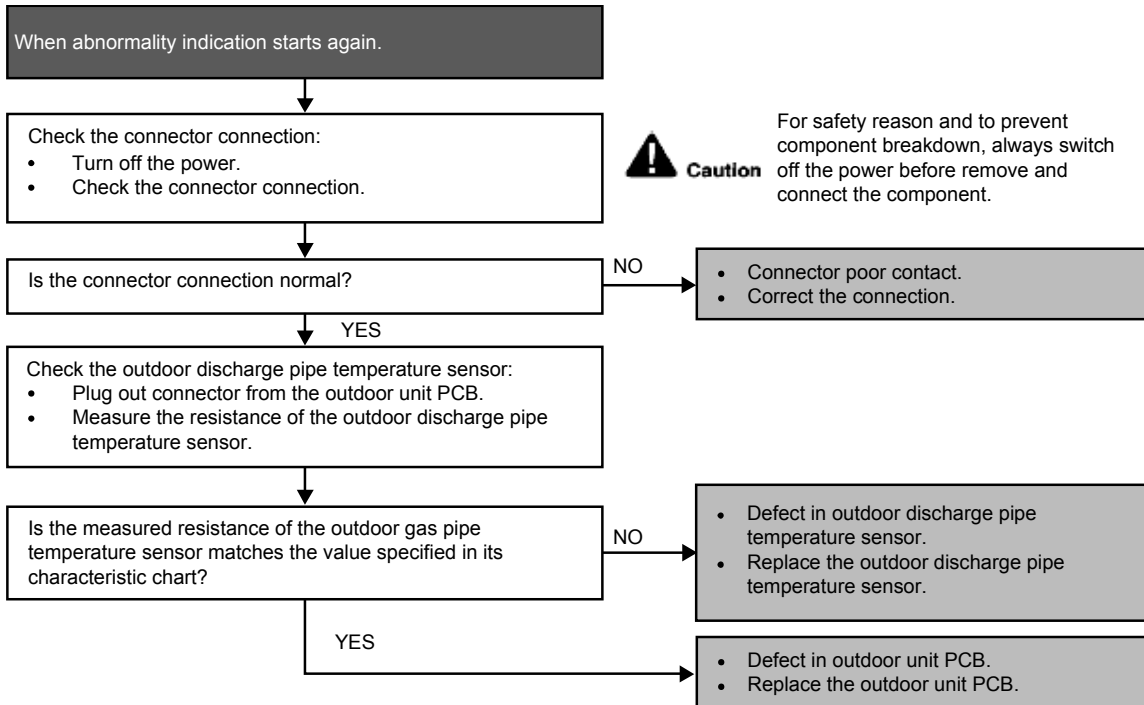

12.4.15 H37 (Outdoor Liquid Pipe Temperature Sensor Abnormality)

Malfunction Decision Conditions

- During startup and operation of cooling and heating, the temperatures detected by the outdoor liquid pipe temperature sensor are used to determine sensor errors.

Malfunction Caused

- Faulty connector connection.
- Faulty sensor.
- Faulty PCB.

Troubleshooting

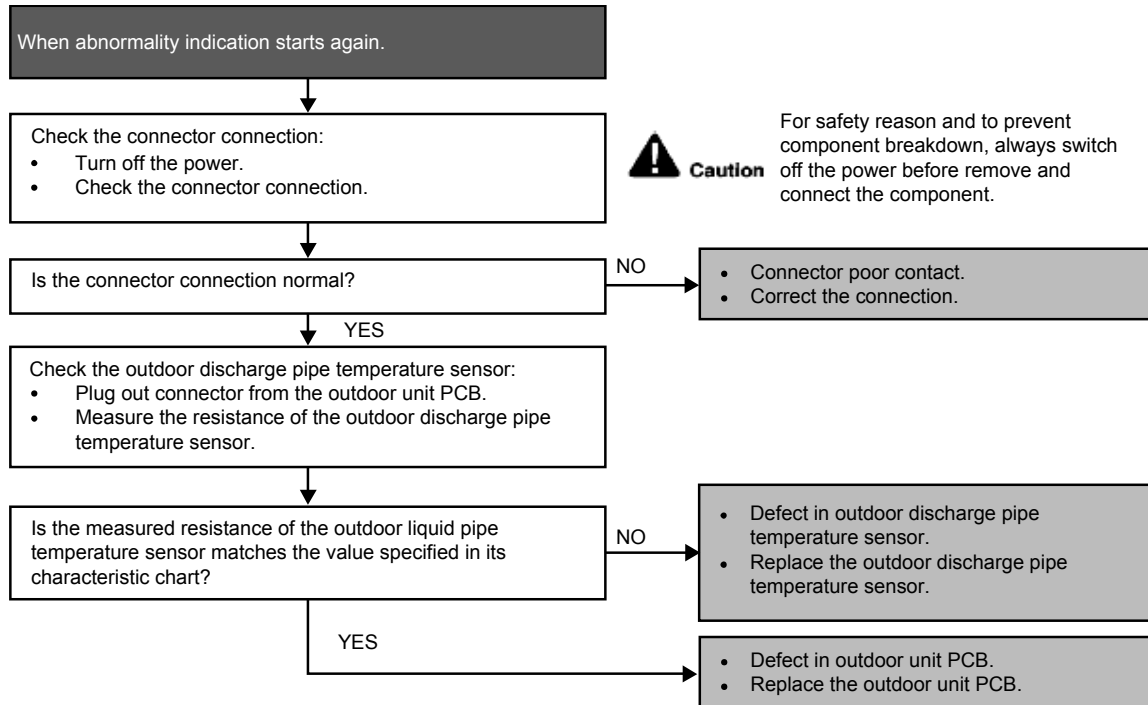

12.4.16 H59 (Human Activity Sensor Abnormality)

Malfunction Decision Conditions

- Feedback signal of human activity sensor.

Malfunction Caused

- Feedback signal is fixed at 0 VDC or 5 VDC continuously for 25 seconds during ECONAVI or AUTO COMFORT operation.
- Feedback signal is detected during ECONAVI or AUTO COMFORT off.

Troubleshooting

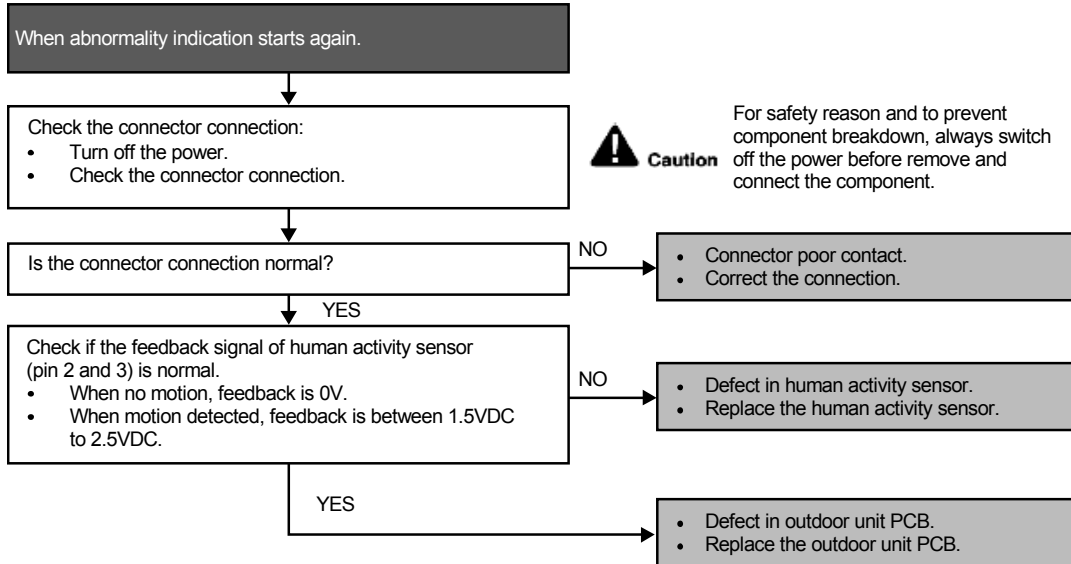

12.4.17 H70 (Light Sensor Abnormality)

Malfunction Decision Conditions

- Feedback signal of light sensor.

Malfunction Caused

- Feedback value is 0 VDC continuously.

Troubleshooting

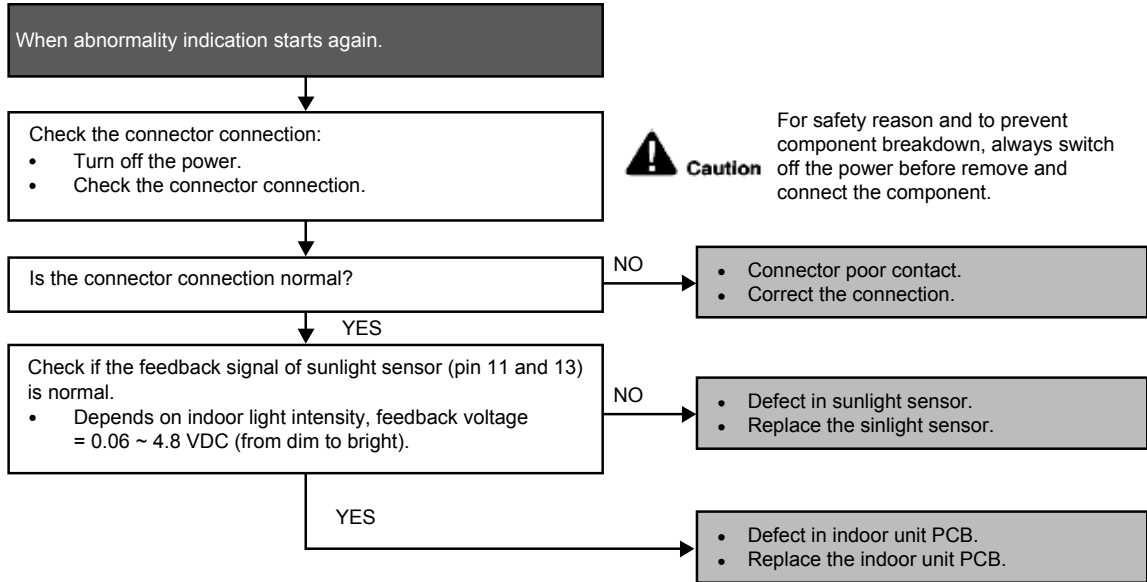

12.4.18 H97 (Outdoor Fan Motor – DC Motor Mechanism Locked)

Malfunction Decision Conditions

- The rotation speed detected by the Hall IC during fan motor operation is used to determine abnormal fan motor.

Malfunction Caused

- Operation stops due to short circuit inside the fan motor winding.
- Operation stops due to breaking of wire inside the fan motor.
- Operation stops due to breaking of fan motor lead wires.
- Operation stops due to Hall IC malfunction.
- Operation error due to faulty outdoor unit PCB.

Troubleshooting

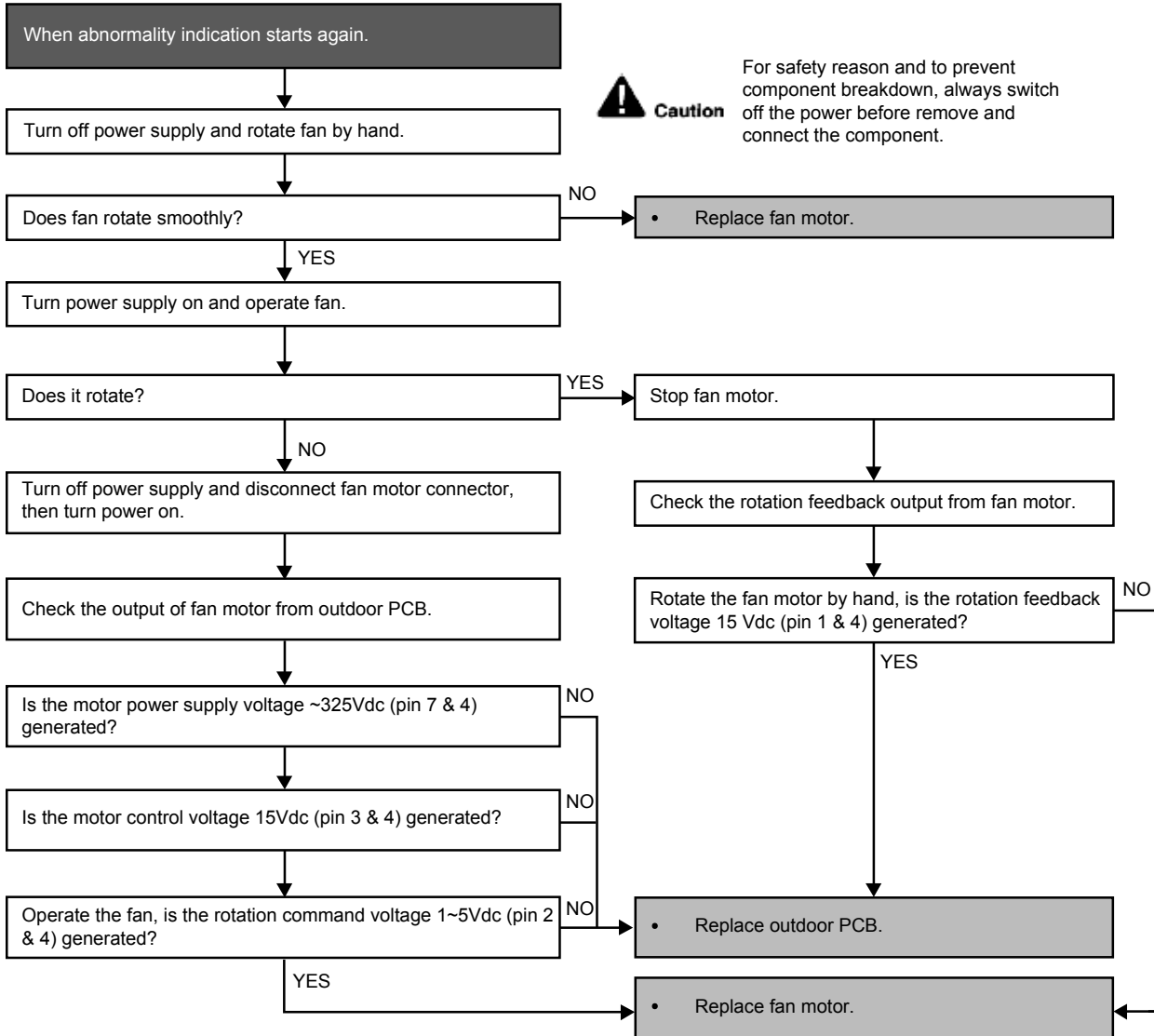

12.4.19 H98 (Error Code Stored in Memory and no alarm is triggered / no TIMER LED flashing)

Malfunction Decision Conditions

- Indoor high pressure is detected when indoor heat exchanger is detecting very high temperature when the unit is operating in heating operation.
- Phenomena: unit is stopping and re-starting very often in heating mode.

Malfunction Caused

- Indoor heat exchanger thermistor.
- Clogged air filter or heat exchanger.
- Over-bent pipe (liquid side).

Troubleshooting

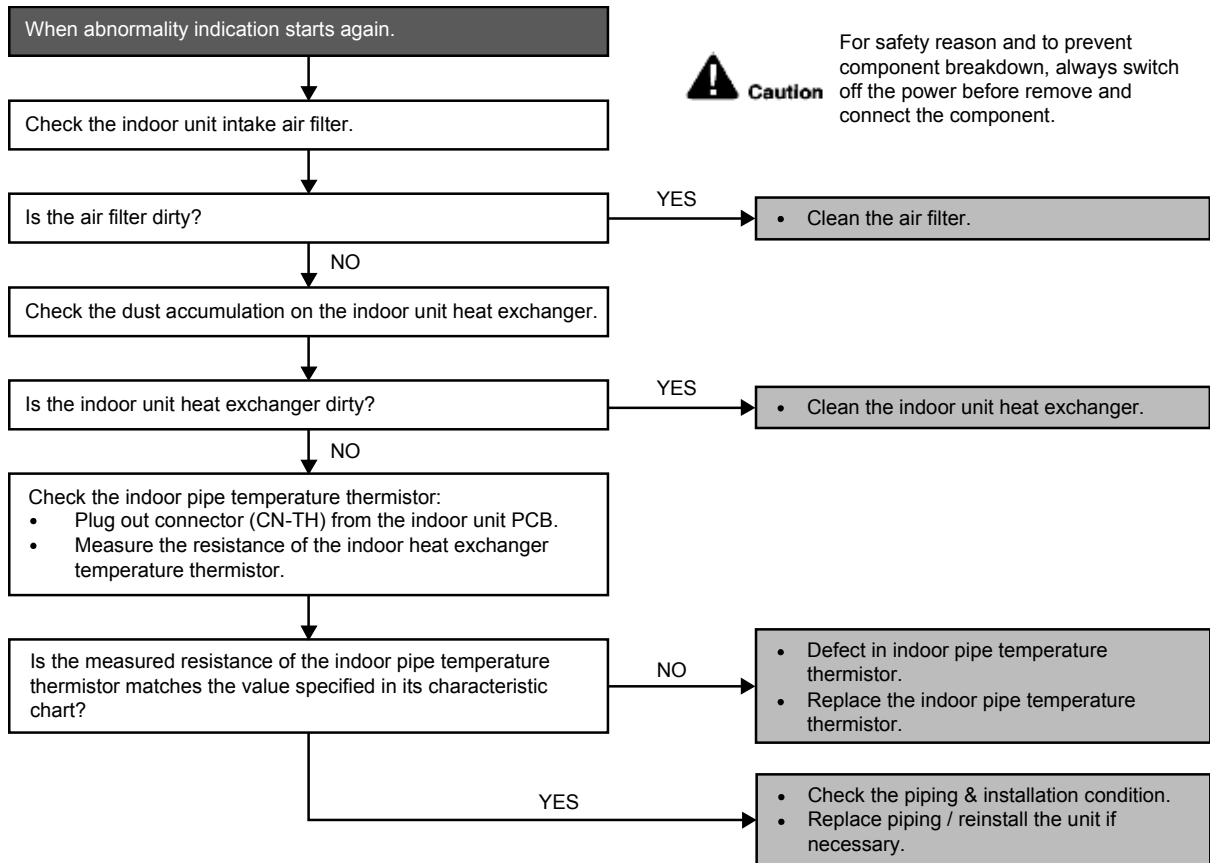

12.4.20 H99 (Indoor Freeze Prevention Protection: Cooling or Soft Dry)

Error Code will not display (no Timer LED blinking) but store in EEPROM

Malfunction Decision Conditions

- Freeze prevention control takes place (when indoor pipe temperature is lower than 2°C).

Malfunction Caused

- Air short circuit at indoor unit.
- Clogged indoor unit air filter.
- Dust accumulation on the indoor unit heat exchanger.
- 2/3 way valve closed.
- Faulty indoor unit fan motor.
- Refrigerant shortage (refrigerant leakage).
- Clogged expansion valve or strainer.
- Faulty indoor pipe temperature sensor.
- Faulty indoor unit PCB.

Troubleshooting

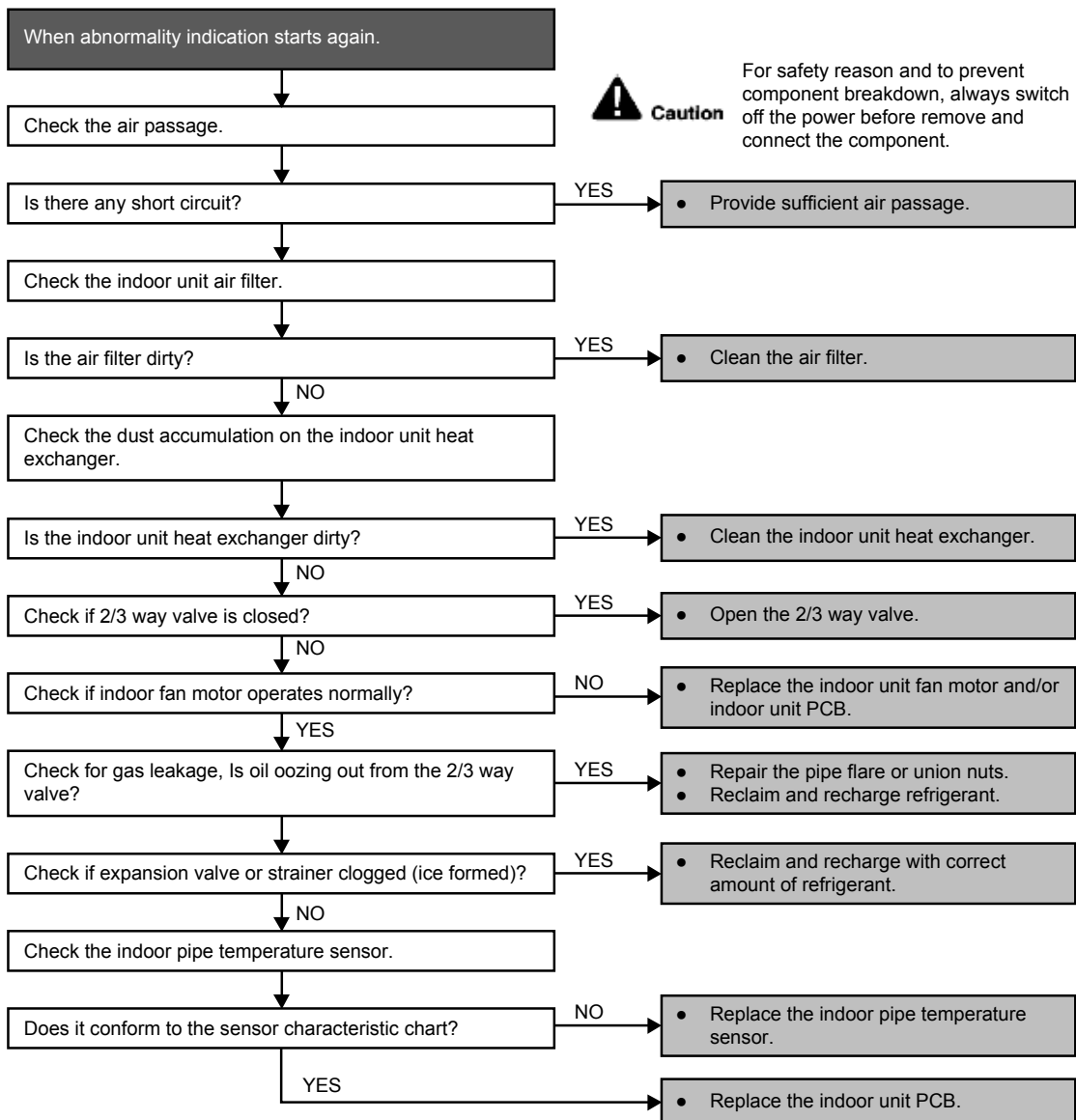

12.4.21 F11 (4-way Valve Switching Failure)

Malfunction Decision Conditions

- When indoor heat exchanger is cold during heating (except deice) or when indoor heat exchanger is hot during cooling and compressor operating, the 4-way valve is detected as malfunction.

Malfunction Caused

- Indoor heat exchanger (pipe) thermistor
- 4-way valve malfunction

Troubleshooting

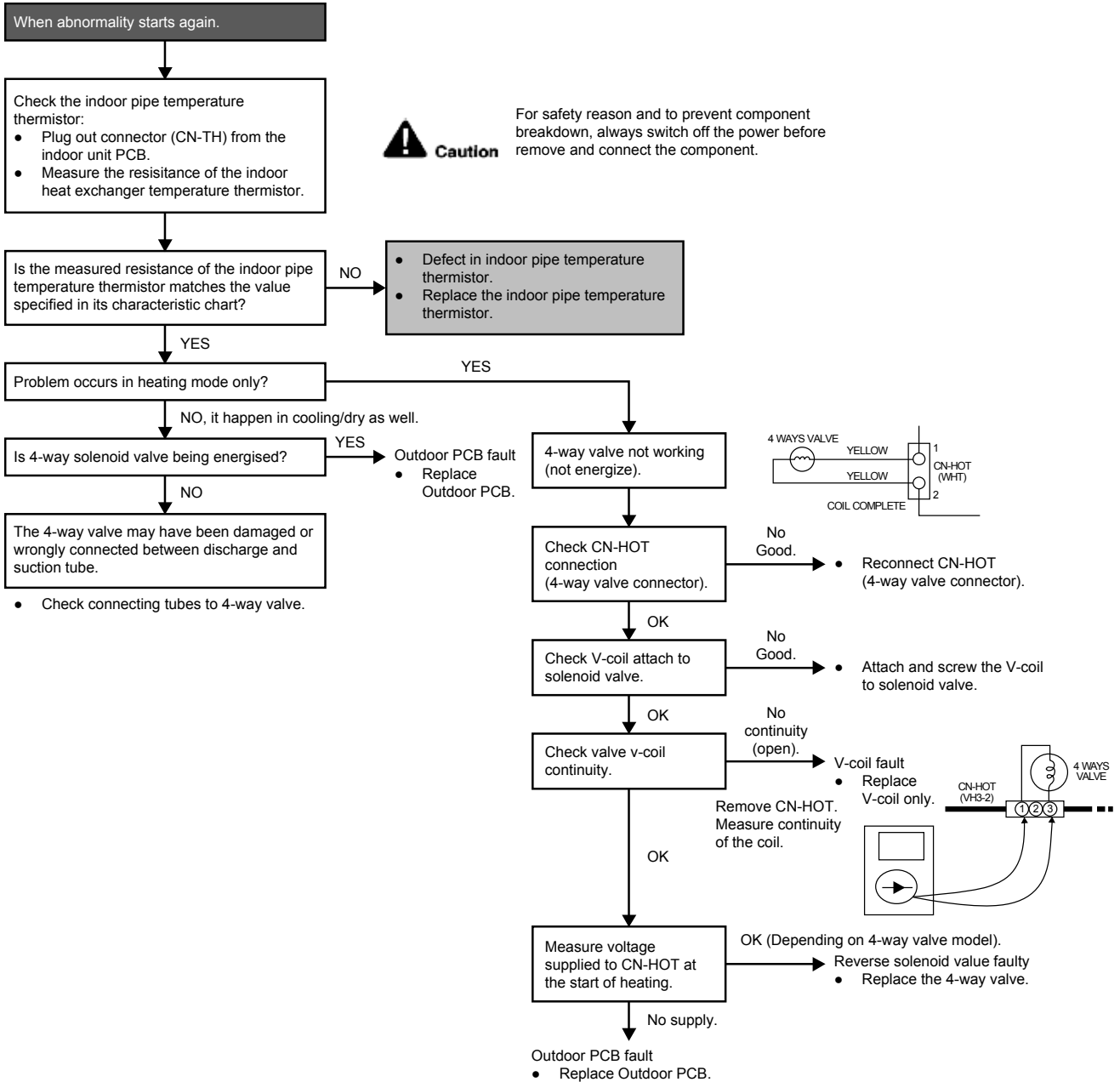

* Check gas side pipe – for hot gas flow in cooling mode



12.4.22 F17 (Indoor Standby Units Freezing Abnormality)

Malfunction Decision Conditions

- When the different between indoor intake air temperature and indoor pipe temperature is above 50°F or indoor pipe temperature is below 30.2°F

Remark:

When the indoor standby unit is freezing, the outdoor unit transfers F17 error code to the corresponding indoor unit and H39 to other indoor unit(s).

Malfunction Caused

- Wrong wiring connection
- Faulty sensor
- Faulty expansion valve

Troubleshooting

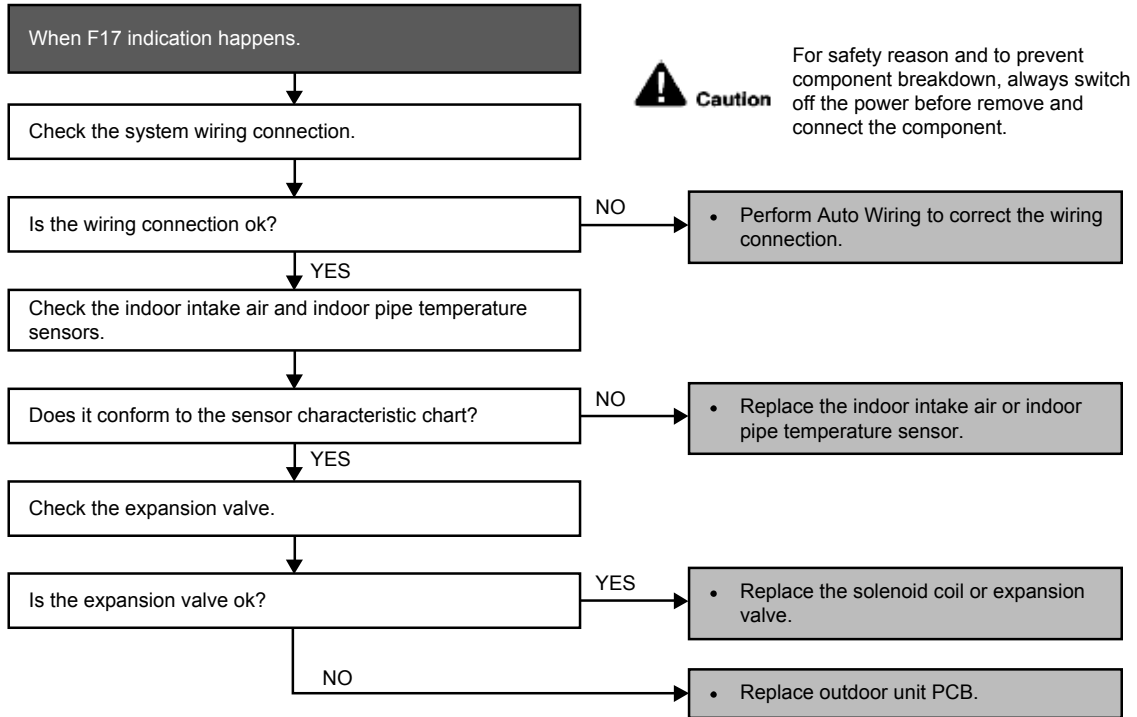

12.4.23 F90 (Power Factor Correction Protection)

Malfunction Decision Conditions

- To maintain DC voltage level supply to power transistor.
- To detect high DC voltage level after rectification.

Malfunction Caused

- During startup and operation of cooling and heating, when Power Factor Correction (PFC) protection circuitry at the outdoor unit main PCB senses abnormal DC voltage level for power transistors.
- When DC voltage detected is LOW, transistor switching will turn ON by controller to push-up the DC level.
- When DC voltage detected is HIGH (391Vdc – 425Vdc), active LOW signal will send by the controller to turn OFF relay RY-C.

Troubleshooting

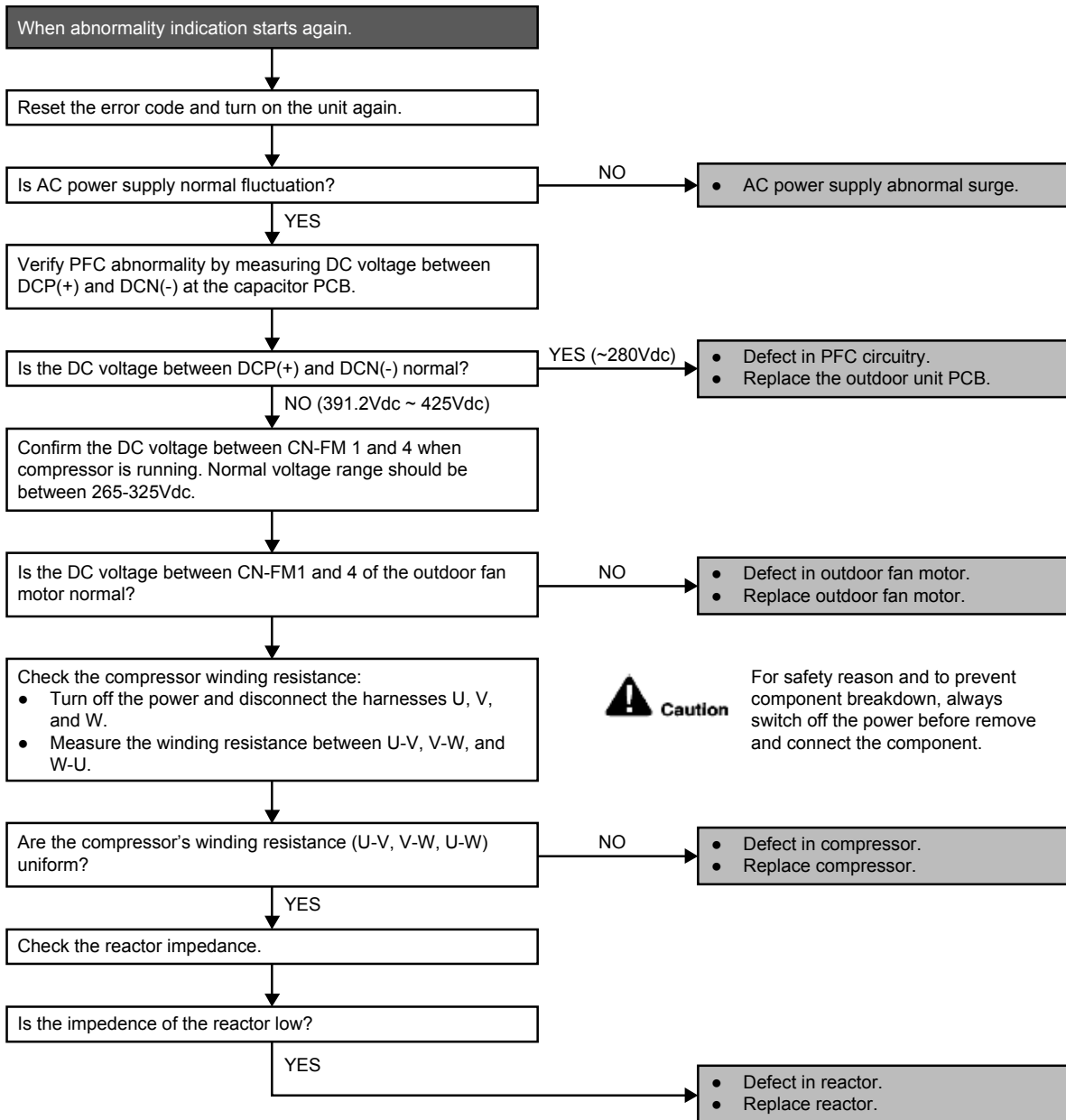

12.4.24 F91 (Refrigeration Cycle Abnormality)

Malfunction Decision Conditions

- The input current is low while the compressor is running at higher than the setting frequency.

Malfunction Caused

- Lack of gas.
- 3-way valve close.

Troubleshooting

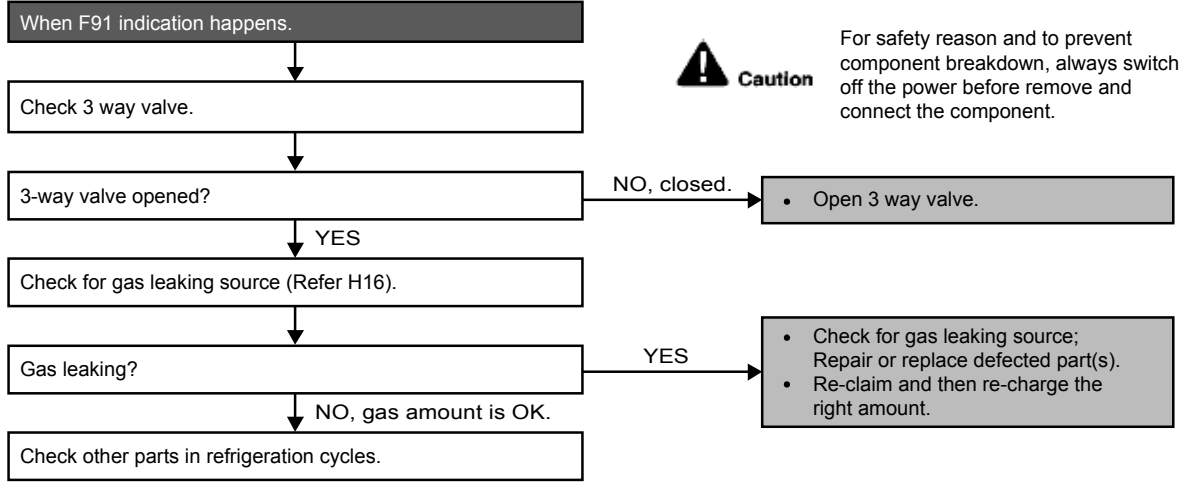

12.4.25 F93 (Compressor Rotation Failure)

Malfunction Decision Conditions

- A compressor rotation failure is detected by checking the compressor running condition through the position detection circuit.

Malfunction Caused

- Compressor terminal disconnect.
- Faulty Outdoor PCB.
- Faulty compressor.

Troubleshooting

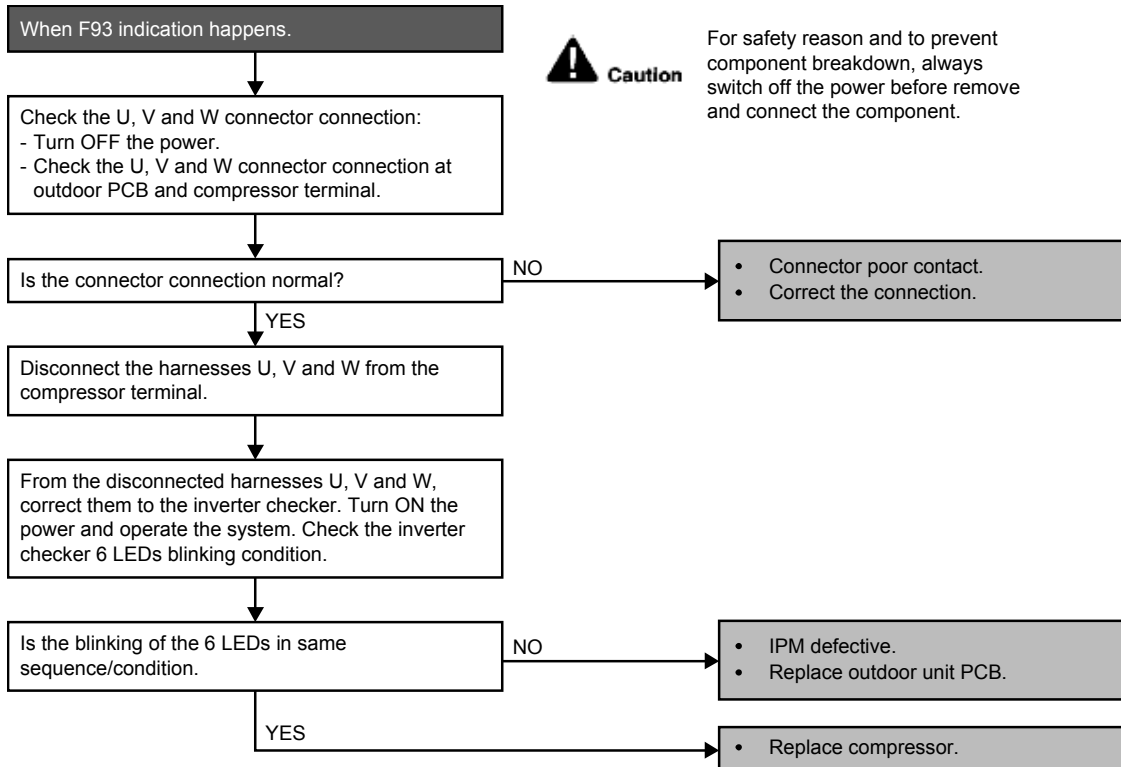

12.4.26 F95 (Outdoor High Pressure Protection: Cooling or Soft Dry)

Malfunction Decision Conditions

- During operation of cooling or soft dry, when outdoor unit heat exchanger high temperature data is detected by the outdoor unit heat exchanger thermistor.

Malfunction Caused

- Outdoor heat exchanger temperature rise due to short-circuit of hot discharge air flow.
- Outdoor heat exchanger temperature rise due to defective of outdoor fan motor.
- Outdoor heat exchanger temperature rise due to defective outdoor heat exchanger thermistor.
- Outdoor heat exchanger temperature rise due to defective of outdoor unit PCB.

Troubleshooting

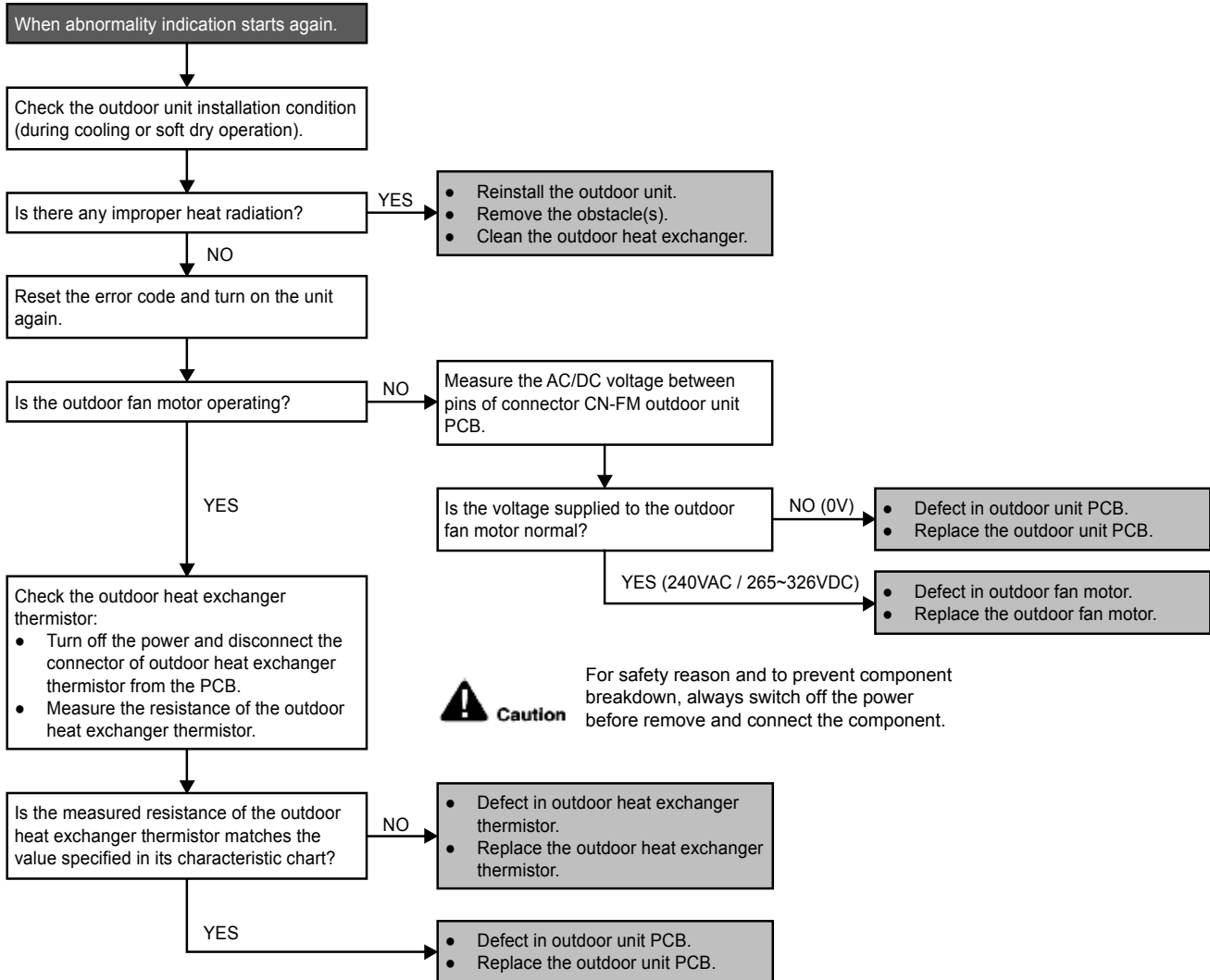

12.4.27 F96 (IPM Overheating)

Malfunction Decision Conditions

- During operating of cooling and heating, when IPM temperature data (212°F) is detected by the IPM temperature sensor.

Multi Models only

- Compressor Overheating: During operation of cooling and heating, when the compressor OL is activated.
- Heat Sink Overheating: During operation of cooling and heating, when heat sink temperature data (194°F) is detected by the heat sink temperature sensor.

Malfunction Caused

- IPM overheats due to short circuit of hot discharge air flow.
- IPM overheats due to defective of outdoor fan motor.
- IPM overheats due to defective of internal circuitry of IPM.
- IPM overheats due to defective IPM temperature sensor.

Multi Models Only

- Compressor OL connector poor contact.
- Compressor OL faulty.

Troubleshooting

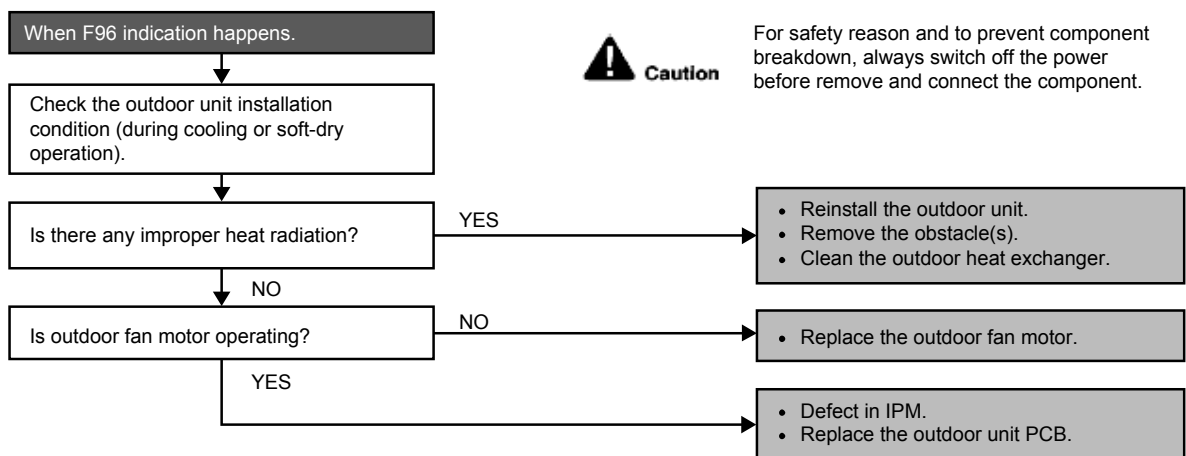

12.4.28 F97 (Compress or Overheating)

Malfunction Decision Conditions

- During operation of cooling and heating, when compressor tank temperature data (233.6°F) is detected by the compressor tank temperature sensor.

Malfunction Caused

- Faulty compressor tank temperature sensor
- 2/3 way valve closed
- Refrigerant shortage (refrigerant leakage)
- Faulty outdoor unit PCB
- Faulty compressor

Troubleshooting

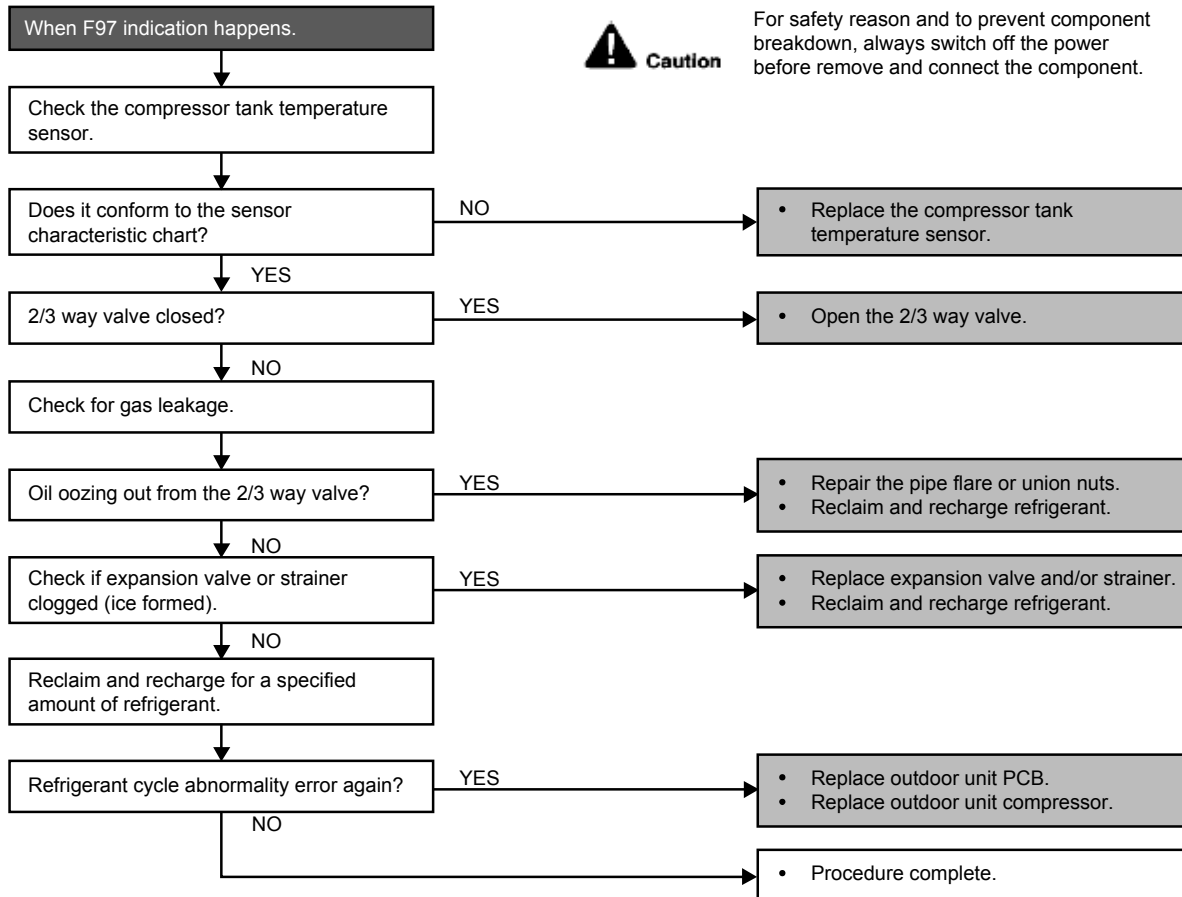

12.4.29 F98 (Input Over Current Detection)

Malfunction Decision Conditions

- During operation of cooling and heating, when an input over-current (X value in Total Running Current Control) is detected by checking the input current value being detected by current transformer (CT) with the compressor running.

Malfunction Caused

- Excessive refrigerant.
- Faulty outdoor unit PCB.

Troubleshooting

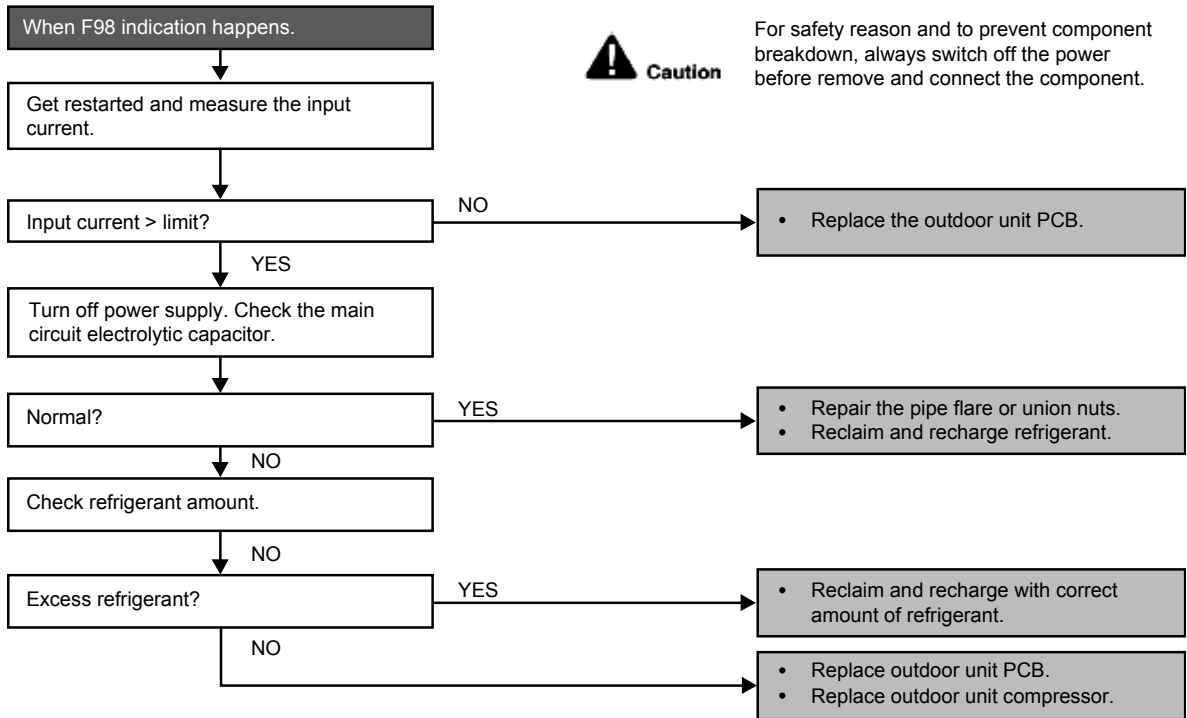

12.4.30 F99 (DC Peak Detection)

Malfunction Decision Conditions

During startup and operation of cooling and heating, when inverter DC peak data is received by the outdoor internal DC Peak sensing circuitry.

Malfunction Caused

- DC current peak due to compressor failure.
- DC current peak due to defective power transistor(s).
- DC current peak due to defective outdoor unit PCB.
- DC current peak due to short circuit.

Troubleshooting

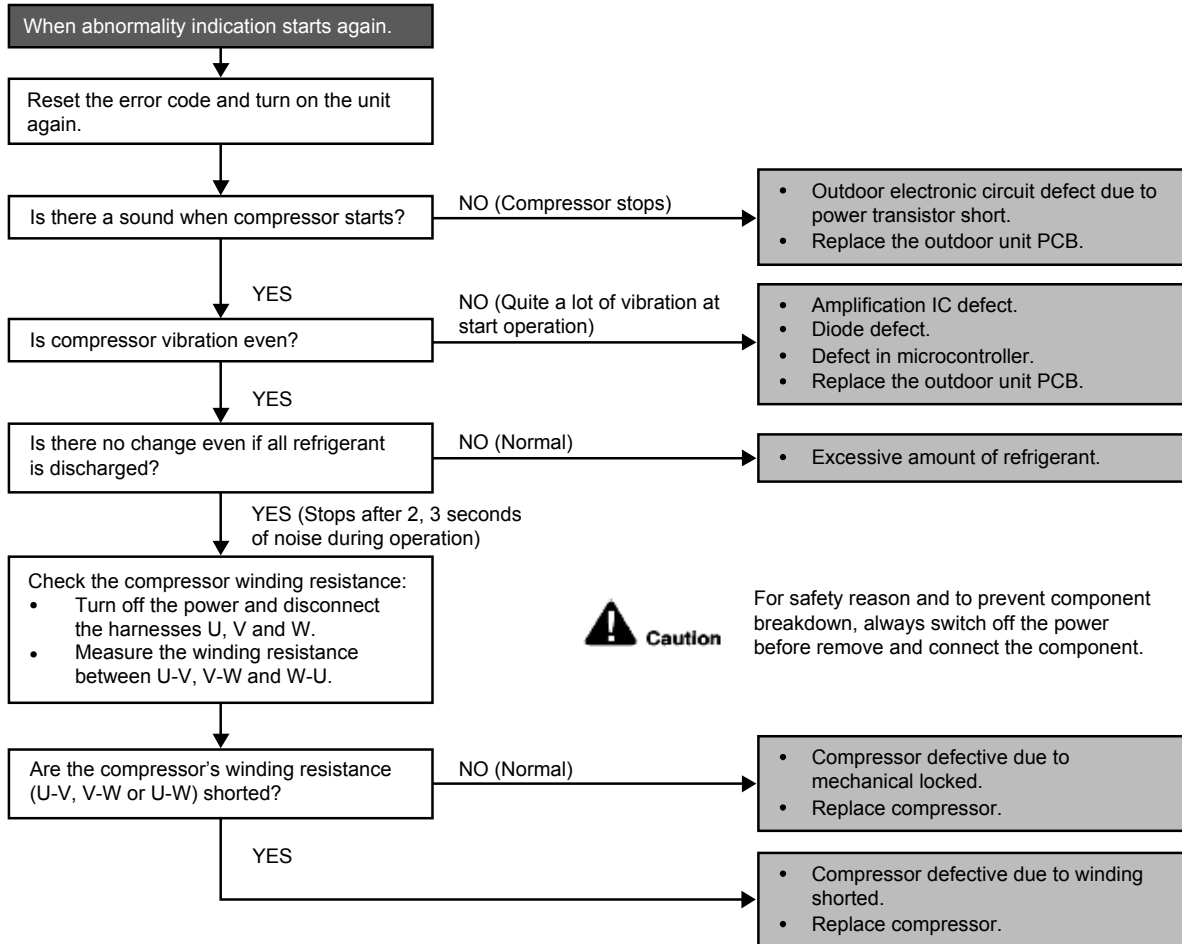

13. Disassembly and Assembly Instructions



WARNING

High Voltage is generated in the electrical parts area by the capacitor. Ensure that the capacitor has discharged sufficiently before proceeding with repair work. Failure to heed this caution may result in electric shocks.

13.1 Indoor Electronic Controllers, Cross Flow Fan and Indoor Fan Motor Removal Procedures

13.1.1 To remove front grille

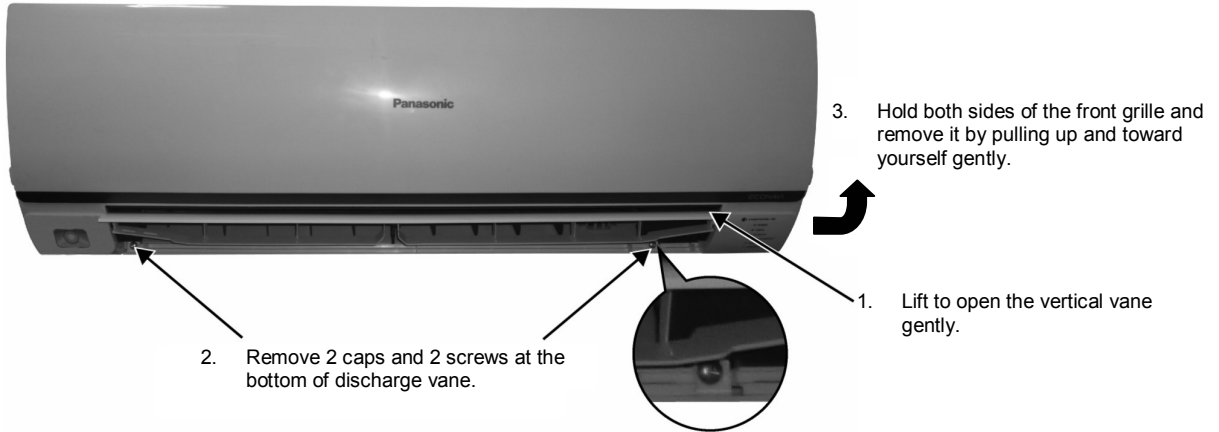

Figure 1

13.1.2 To remove power electronic controller

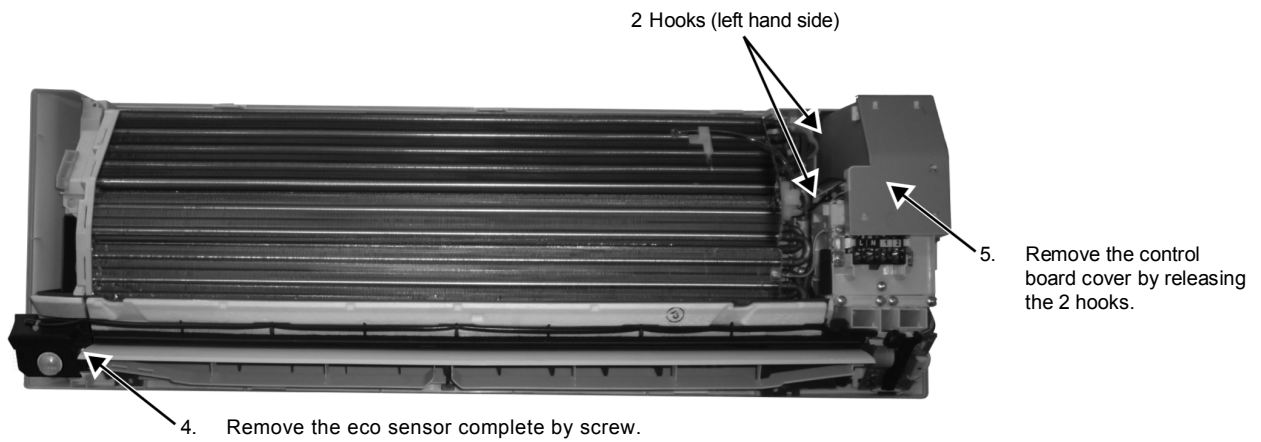

Figure 2



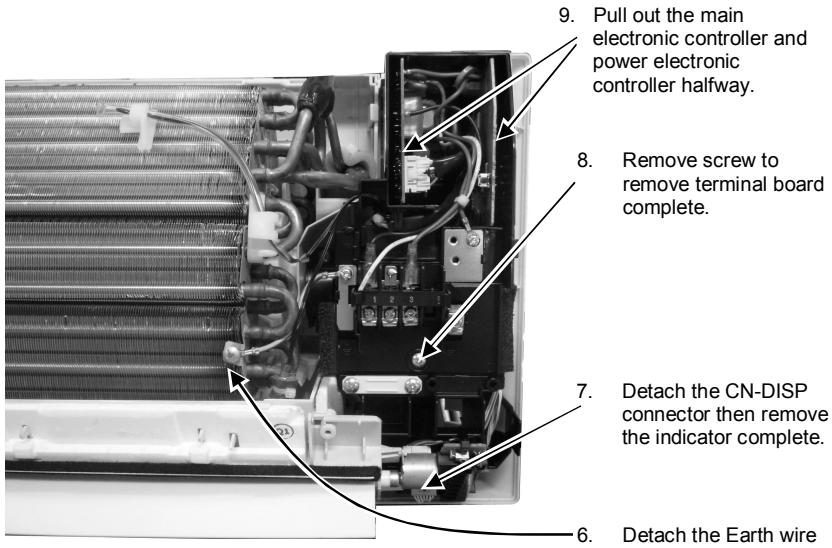

Figure 3

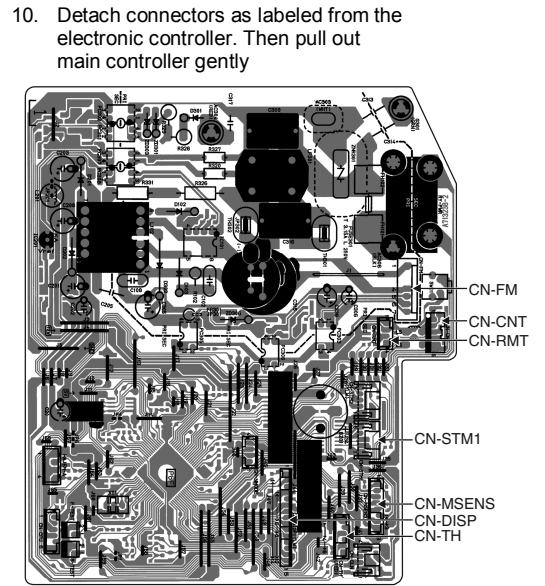

Figure 4

13.1.3 To remove discharge grille



Figure 5

13.1.4 To remove control board

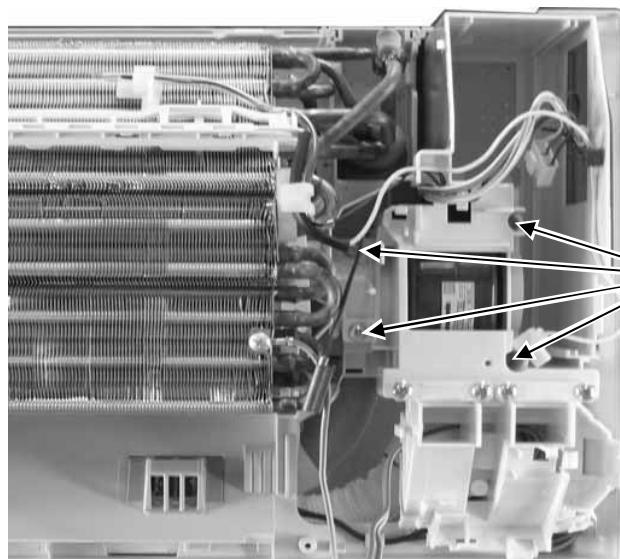

Figure 6



13.1.5 To remove cross flow fan and indoor fan motor

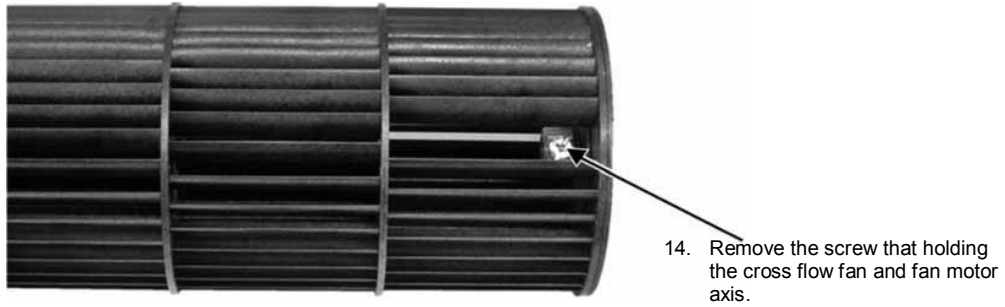

Figure 7

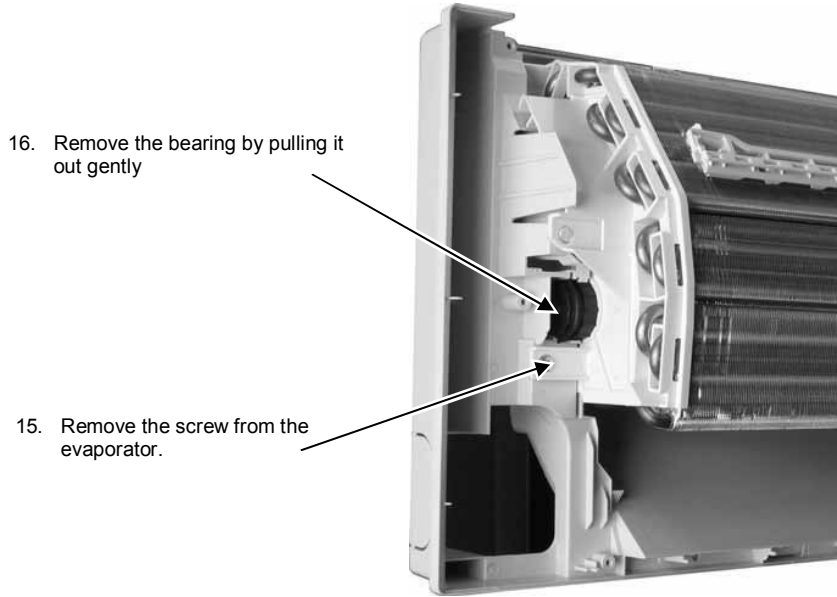

Figure 8

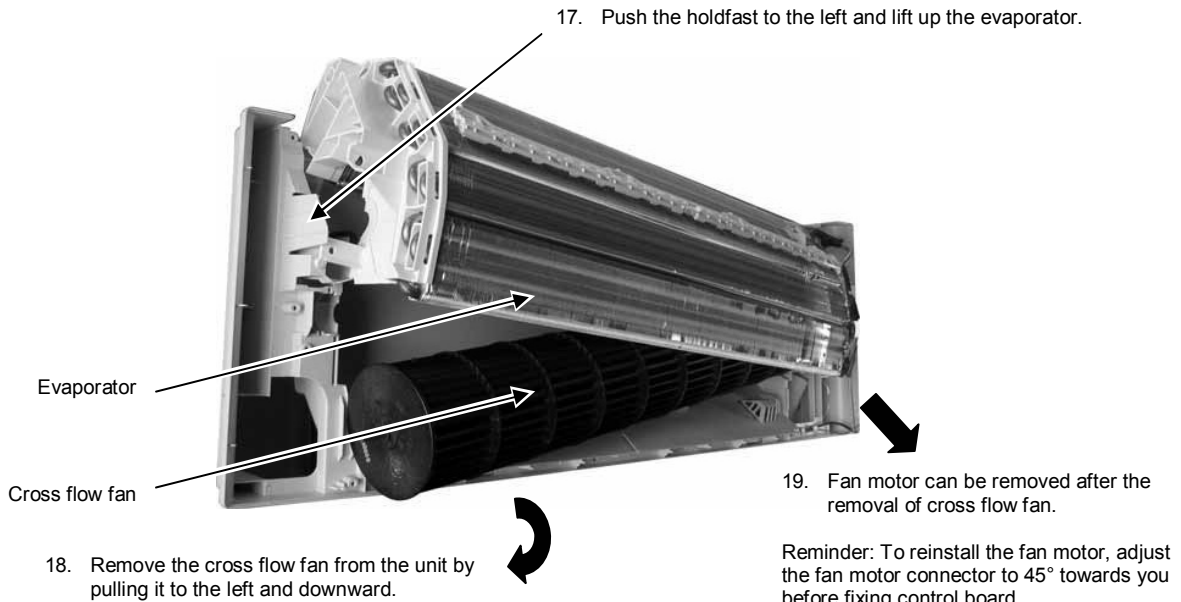
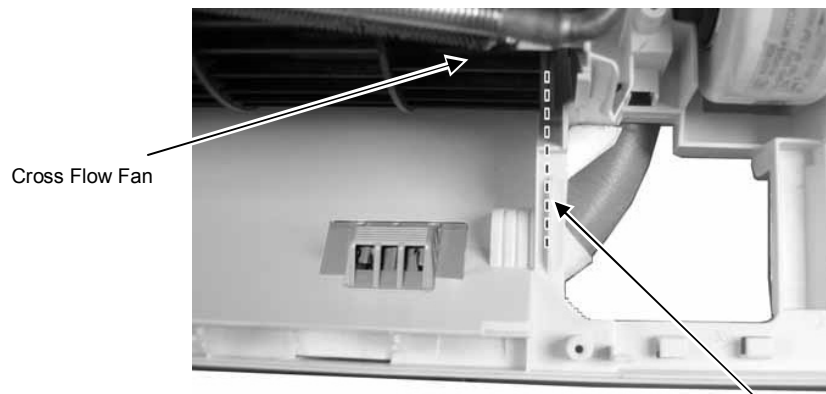

Figure 9



Cross Flow Fan

Reminder: To reinstall the cross flow fan, ensure cross flow fan is in line as shown in figure 10

Figure 10

14. Exploded View and Replacement Parts List

14.1 Indoor Unit

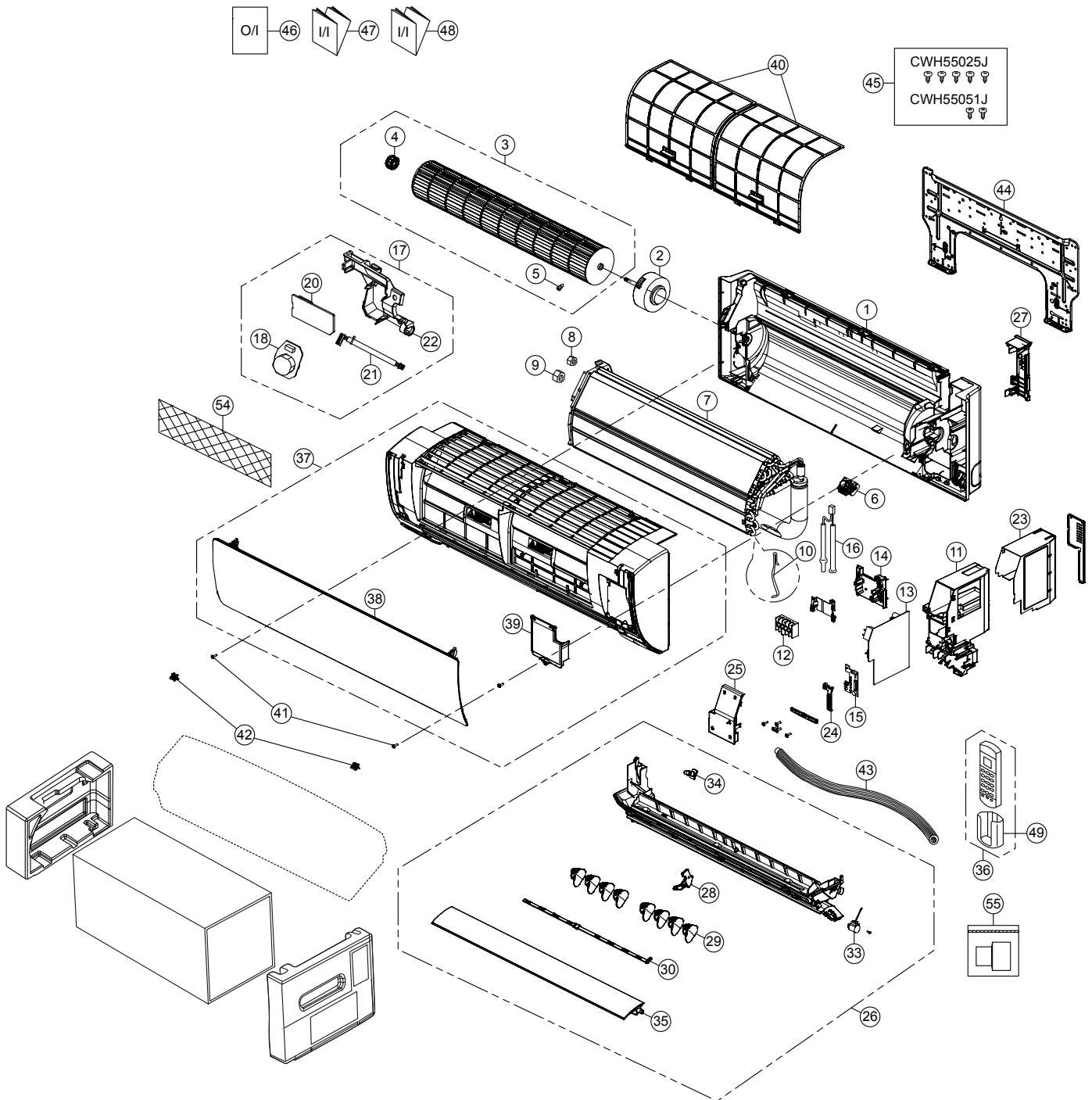

Note
 The above exploded view is for the purpose of parts disassembly and replacement.
 The non-numbered parts are not kept as standard service parts.



SAFETY	REF. NO.	DESCRIPTION & NAME	QTY	CS-ME5RKUA	REMARK
	1	CHASSIS COMPLETE	1	CWD50C1633	
⚠	2	FAN MOTOR	1	L6CBYYL0055	O
	3	CROSS FLOW FAN COMPLETE	1	CWH02C1076	
	4	BEARING	1	CWH64K007	
	5	SCREW	1	CWH551146	
	7	EVAPORATOR CO.	1	CWB30C3504	
	8	FLARE NUT (1/4) - LIQUID	1	CWT251030	
	9	FLARE NUT (3/8) - GAS	1	CWT251031	
	11	CONTROL BOARD CASING	1	CWH102605A	
⚠	12	TERMINAL BOARD COMPLETE	1	CWA28C2357	
⚠	13	ELECTRONIC CONTROLLER - MAIN	1	CWA73C9301	O
⚠	15	ELECTRONIC CONTROLLER - INDICATOR	1	CWA748158	O
	16	SENSOR COMPLETE	1	CWA50C2800	O
	17	SENSOR COMPLETE (ECO)	1	CWA50C2820	O
⚠	18	ELECTRONIC CONT (ECO SENSOR)	1	CWA745791	
⚠	20	ELECTRONIC CONT (COMPARATOR)	1	CWA746769	
	21	LEADWIRE-PCB ECO	1	CWA67C9786	
	23	CONTROL BOARD TOP COVER	1	CWH131467	
	24	INDICATOR HOLDER	1	CWD933406	
	25	CONTROL BOARD FRONT COVER CO.	1	CWH13C1333	
	26	DISCHARGE GRILLE COMPLETE	1	CWE20C3495	
	27	BACK COVER CHASSIS	1	CWD933233B	
	28	FULCRUM	1	CWH621131	
	29	VERTICAL VANE	8	CWE241374	
	30	CONNECTING BAR	1	CWE261251	
⚠	33	AIR SWING MOTOR	1	CWA981264	O
	34	CAP	1	CWH521096	
	35	HORIZONTAL VANE COMPLETE	1	CWE24C1385	
	36	REMOTE CONTROL COMPLETE	1	CWA75C4567	O
	37	FRONT GRILLE COMPLETE	1	CWE11C5960	O
	38	INTAKE GRILLE COMPLETE	1	CWE22C1946	
	39	GRILLE DOOR COMPLETE	1	CWE14C1131	
	40	AIR FILTER	2	CWD001279	O
	41	SCREW-F/GRILLE MOUNT	2	XTT4+16CFJ	
	42	CAP-FRONT GRILLE	2	CWH521227	
	43	DRAIN HOSE	1	CWH851173	
	44	INSTALLATION PLATE	1	CWH361134	
	45	BAG COMPLETE - INSTALLATION SCREW	1	CWH82C1705	
	46	OPERATING INSTRUCTION	1	CWF569978	
	47	INSTALLATION INSTRUCTION	1	CWF616708	
	48	INSTALLATION INSTRUCTION	1	CWF616709	
	49	REMOTE CONTROL HOLDER	1	CWH361078	
	54	AIR PURIFYING FILTER	1	CWD00C1141	
	55	BAG COMPLETE (TUBE CONNECTOR)	1	CWH82C2030	

(Note)

- All parts are supplied from PHAAM, Malaysia (Vendor Code: 00029488).
- "O" marked parts are recommended to be kept in stock.

SAFETY	REF. NO.	PART NAME & DESCRIPTION	QTY.	CS-ME7RKUA	REMARK
	1	CHASSIS COMPLETE	1	CWD50C1633	
	2	FAN MOTOR	1	L6CBYYYYL0055	O
	3	CROSS-FLOW FAN COMPLETE	1	CWH02C1076	
	4	BEARING ASSY	1	CWH64K007	
	5	SCREW - CROSS - FLOW FAN	1	CWH551146	
	6	PARTICULAR PIECE	1	CWD933067	
	7	EVAPORATOR	1	CWB30C5033	
	8	FLARE NUT (LIQUID)	1	CWT251030	
	9	FLARE NUT (GAS)	1	CWT251031	
	10	CLIP FOR SENSOR	1	CWH321085	
	11	CONTROL BOARD CASING	1	CWH102605A	
	12	TERMINAL BOARD COMPLETE	1	CWA28C2357	O
	13	ELECTRONIC CONTROLLER - MAIN	1	CWA73C9225	O
	14	PARTICULAR PIECE - TERMINAL	1	CWD933137A	
	15	ELECTRONIC CONTROLLER - INDICATOR	1	CWA748158	O
	16	SENSOR COMPLETE	1	CWA50C3228	O
	17	SENSOR COMPLETE (ECO)	1	CWA50C2820	O
	18	ELECTRONIC CONTROLLER (ECO SENSOR)	1	CWA745791	
	20	ELECTRONIC CONTROLLER (COMPARATOR)	1	CWA746769	
	21	LEAD WIRE - PCB ECO	1	CWA67C9786	
	22	CONTROL BOARD CASING FOR PCB ECO	1	CWD933427	
	23	CONTROL BOARD TOP COVER	1	CWH131467	
	24	INDICATOR HOLDER	1	CWD933406	
	25	CONTROL BOARD FRONT COVER CO.	1	CWH13C1333	
	26	DISCHARGE GRILLE COMPLETE	1	CWE20C3495	
	27	BACK COVER CHASSIS	1	CWD933233B	
	28	FULCRUM	1	CWH621131	
	29	VERTICAL VANE	8	CWE241374	
	30	CONNECTING BAR	2	CWE261251	
	33	AIR SWING MOTOR	1	CWA981264	
	34	CAP - DRAIN TRAY	1	CWH521259	
	35	HORIZONTAL VANE COMPLETE	1	CWE24C1385	
	36	REMOTE CONTROL COMPLETE	1	CWA75C4567	O
	37	FRONT GRILLE COMPLETE	1	CWE11C5960	O
	38	INTAKE GRILLE COMPLETE	1	CWE22C1946	
	39	GRILLE DOOR COMPLETE	1	CWE14C1131	
	40	AIR FILTER	2	CWD001279	O
	41	SCREW - FRONT GRILLE	2	XTT4+16CFJ	
	42	CAP - FRONT GRILLE	2	CWH521227	
	43	DRAIN HOSE	1	CWH851173	
	44	INSTALLATION PLATE	1	CWH361134	
	45	BAG COMPLETE - INSTALLATION SCREW	1	CWH82C1705	
	46	OPERATING INSTRUCTION	1	CWF569978	
	47	INSTALLATION INSTRUCTION	1	CWF616708	
	48	INSTALLATION INSTRUCTION	1	CWF616709	
	49	REMOTE CONTROL HOLDER	1	CWH361078	

SAFETY	REF. NO.	PART NAME & DESCRIPTION	QTY.	CS-ME7RKUA	REMARK
	54	AIR PURIFYING FILTER	1	CWD00C1141	
	55	BAG COMPLETE (TUBE CONNECTOR)	1	CWH82C2030	

(Note)

- All parts are supplied from PHAAM, Malaysia (Vendor Code: 00029488).
- "O" marked parts are recommended to be kept in stock.