

# Contents

<b>1 Instructions</b>	<b>4</b>
1.1 General safety instructions	4
1.2 Appliance purpose	8
1.3 Manufacturer liability	8
1.4 This user manual	9
1.5 Identification plate	9
1.6 Disposal	9
1.7 How to read the user manual	10
<b>2 Description</b>	<b>11</b>
2.1 General description	11
2.2 Symbols	11
2.3 Available accessories	13
<b>3 Use</b>	<b>14</b>
3.1 Instructions	14
3.2 Precautions	15
3.3 First use	15
3.4 Using the gas burners	15
3.5 Using the induction hot plates	17
3.6 Special functions	25
3.7 Additional functions	26
3.8 User menu	28
3.9 Error codes	30
3.10 Practical advice	31
<b>4 Cleaning and maintenance</b>	<b>32</b>
4.1 Instructions	32
4.2 Cleaning the appliance	32
4.3 What to do if...	34
<b>5 Installation</b>	<b>35</b>
5.1 Minimum clearance to combustible surface	35
5.2 Mounting	35
5.3 Section cut from the work surface	36
5.4 Gas connection	40
5.5 Adaptation to different types of gas	41
5.6 Electrical connection	45
5.7 Instructions for the installer	47

## TRANSLATION OF THE ORIGINAL INSTRUCTIONS

These instructions apply only for the destination countries listed on the appliance's data plate.

This is a class 3 built in hob.

We advise you to read this manual carefully, which contains all the instructions for maintaining the appliance's aesthetic and functional qualities.

For further information on the product: [www.smeg.com](http://www.smeg.com)



# Instructions

## 1 Instructions

### 1.1 General safety instructions

#### Risk of personal injury

- During use the appliance and its accessible parts become very hot. Never touch the heating elements during use.
- Never try to put out a fire or flames with water: turn off the appliance and smother the flames with a fire blanket or other appropriate cover.
- This appliance is not intended for use by persons (including children) with reduced physical, sensory or mental capabilities, or lack of experience and knowledge, unless they have been given supervised or instruction concerning use of the appliance by a responsible person for their safety.
- This appliance may be used by children aged at least 8 and by people of reduced physical, sensory or mental capacity, or lacking in experience in the use of electrical appliances, as long they are supervised or instructed by adults who are responsible for their safety.
- Children must not be allowed to play with the appliance.
- Young children should be supervised the do not play with the appliance.
- During use the appliance becomes hot. Care should be taken to avoid touching heating elements inside the oven.
- **WARNING** - Accessible parts becomes very hot when in use. To avoid burns young children should be kept away.
- Keep children under eight years of age at a safe distance if they are not constantly supervised.
- Do not allow children younger than 8 years old to come near the appliance when in operation.
- Cleaning and maintenance must not be carried out by unsupervised children.
- **WARNING**: If the surface is cracked, switch off the appliance to avoid the possibility of electric shock, for hob surfaces of glass ceramic or similar material which protect live parts.
- **CAUTION**: The cooking process has to be supervised. A short-term cooking process has to be supervised continuously.
- **WARNING**: Unattended cooking on a hob with fat or oil can be dangerous and may result in a fire.
- **WARNING**: The appliance and its accessible parts become hot during use.



- **WARNING:** Danger of fire: do not store items on the cooking surfaces.
- Means for disconnection of appliance must be incorporated in the fixed wiring in accordance with the wiring rules.
- Make sure that the flame-spreader crowns are correctly positioned in their housings with their respective burner caps.
- Be aware of how rapidly the cooking zones heat up. Do not place empty pans on the heat. Danger of overheating.
- Fats and oils can catch fire if they overheat. Do not leave the appliance unattended while preparing foods containing oils or fats. If fats or oils catch fire, never put water on them. Place the lid on the pan and turn off the relevant cooking zone.
- The cooking process must always be monitored. Short cooking processes must be monitored continuously.
- Metallic objects such as knives, forks, spoons and lids should not be placed on the hotplate since they can get hot.
- Do not insert pointed metal objects (cutlery or utensils) into the slots in the appliance.
- Do not pour water directly onto very hot trays.
- **DO NOT USE OR STORE FLAMMABLE MATERIALS IN THE APPLIANCE STORAGE DRAWER (IF PRESENT) OR NEAR THIS APPLIANCE.**
- **DO NOT SPRAY AEROSOLS IN THE VICINITY OF THIS APPLIANCE WHILE IT IS IN OPERATION.**
- Switch the appliance off immediately after use.
- **DO NOT MODIFY THIS APPLIANCE.**
- Do not try to repair the appliance yourself or without the intervention of authorised persons.
- **DO NOT USE THIS APPLIANCE AS A SPACE HEATER.**
- **DO NOT PLACE ARTICLES ON OR AGAINST THIS APPLIANCE.**
- **NOT SUITABLE FOR USE WITH AFTERMARKET LIDS OR COVERS.**
- Do not pull the cable to remove the plug.
- If the supply cord is damaged, it must be replaced by the manufacturer or its service agent or a similar qualified person in order to avoid hazard.
- **Danger of fire - Do not store items on the cooking surface.**



## Instructions

### Risk of damaging the appliance

- Do not use harsh abrasive cleaners or sharp metal scrapers to clean glass since they can scratch the surface, which may result in shattering of the glass.
- Use wooden or plastic utensils.
- Do not seat on the appliance.
- Do not obstruct ventilation openings and heat dispersal slots.
- CAUTION - The cooking process has to be supervised. A short term cooking process has to be supervised continuously.
- WARNING - Unattended cooking on a hob with fat or oil can be dangerous and may result in a fire.
- Never leave the appliance unattended during cooking operations in which fats or oils could be released that could overheat and catch fire. Be very careful.
- Never leave objects on the cooking surface.
- DO NOT USE THE APPLIANCE TO HEAT ROOMS FOR ANY REASON.
- Do not spray any spray products near the oven.
- Do not use plastic kitchenware or containers when cooking food.

- The cooking vessels or griddle plates should be placed inside the perimeter of the cooktop.
- All cookware must have smooth, flat bottoms.
- If any liquid does boil over or spill, remove the excess from the cooktop.
- Take care not to spill acidic substances such as lemon juice or vinegar onto the cooktop.
- Do not put empty pans or frying pans on switched on cooking zones.
- Do not use a steam cleaner to clean this appliance.
- Do not use rough or abrasive materials or sharp metal scrapers.
- Do not use cleaning products containing chlorine, ammonia or bleach on steel parts or parts with metallic surface finishes (e.g. anodizing, nickel- or chromium-plating).
- Do not wash the removable components such as the cooktop trivets, flame-spreader crowns and burner caps in a dishwasher.

### Installation

- THIS APPLIANCE **MUST NOT BE INSTALLED** IN BOATS OR CARAVANS.
- The appliance must not be installed on a stand.



- Position the appliance into the cabinet cutout with the help of a second person.
- To prevent overheating, the appliance must not be installed behind a decorative door or a panel.
- Before carrying out any work on the appliance (installation, maintenance, positioning or moving), wear personal protective equipment.
- Before carrying out any work on the appliance, disconnect the mains power supply.
- Have authorised persons carry out installation and assistance interventions according to the standards in force.
- If the electrical supply is restricted, means of all-pole disconnection must be accessible and incorporated in the fixed wiring in accordance with the wiring rules.
- The gas connection should be carried out by authorised persons.
- Installation with flexible hose must be carried out so that the length of the piping does not exceed 2 metres when fully extended as regards flexible steel hoses and 1.5 metres in case of rubber hoses.
- The hoses should not come into contact with moving parts and should not be crushed in any way.
- If required, use a pressure regulator that complies with current regulations.
- After carrying out any operation, check that the tightening torque of gas connections is between 10 Nm and 15 Nm.
- At the end of the installation, check for any leaks with a soapy solution, never with a flame.
- Have the electrical connection performed by authorised persons.
- The appliance must be connected to earth in compliance with electrical system safety standards.
- Use cables withstanding a temperature of at least 90°C.
- The tightening torque of the screws of the terminal supply wires must be 1.5 - 2 Nm.
- The power cable must only be replaced by authorised persons.
- Before installation, make sure that the local gas supply (gas type and pressure) and the settings of the domestic appliance are compatible.
- The settings for this domestic appliance are shown on the gas setting label.



## Instructions

- This domestic appliance is not connected to a device for extracting combustion products. It must be installed and connected in accordance with current installation regulations. Pay particular attention to the relevant requirements regarding ventilation.
- People who have pacemakers or other similar devices fitted must make sure that the operation of these devices is not jeopardised by the inductive field, whose frequency range is between 20 and 50 kHz.

### For this appliance

- Switch off the hot plates after use. Never rely solely on the cookware detector.
- Supervise children carefully as they cannot easily see the indication that there is residual heat. After use the cooking zones remain hot for a certain period of time even if they have been turned off. Keep children away from the cooking zones.
- The glass ceramic surface is highly resistant to impact. However, prevent hard, solid objects falling onto the cooking surface as they may cause it to break if they are sharp.
- The glass ceramic cooking surface must not be used as a surface for placing objects.
- **WARNING:** If the surface is cracked, switch off the appliance to avoid the possibility of an electric shock.
- 

- In conformity with the provisions regarding electromagnetic compatibility, the electromagnetic induction cooking hob comes under group 2 and class B (EN 55011).

### 1.2 Appliance purpose

- This appliance is intended for cooking food in the home environment. Every other use is considered improper.
- This appliance is not intended to be operated by means of external timer or separate remote control system.

### 1.3 Manufacturer liability

The manufacturer declines all liability for damage to persons or property caused by:

- Use of the appliance other than that specified;
- Failure to comply with the instructions in the user manual;
- Tampering with any part of the appliance;
- The use of non-original spare parts.



## 1.4 This user manual

This user manual is an integral part of the appliance and must therefore be kept in its entirety and within the user's reach for the whole working life of the appliance.

Read this user manual carefully before using the appliance.

## 1.5 Identification plate

The identification plate bears the technical data, serial number and brand name of the appliance. Do not remove the identification plate for any reason.

Place the supplied data plate to a suitable surface or within the instruction manual for future reference.

## 1.6 Disposal



This appliance conforms to the WEEE European directive (2012/19/EU) and must be disposed of separately from other waste at the end of its service life. The appliance does not contain substances in quantities sufficient to be considered hazardous to health and the environment, in accordance with current European directives.

To dispose of the appliance:

- Cut the power supply cable and remove it along with the plug.



### Power voltage

### Danger of electrocution

- Disconnect the mains power supply.
- Unplug the appliance.
- Deliver the appliance to the appropriate recycling centre for electrical and electronic equipment waste, or return it to the retailer when purchasing an equivalent product, on a one for one basis.

Our appliances are packaged in non-polluting and recyclable materials.

- Deliver the packing materials to the appropriate recycling centre.



### Plastic packaging

### Danger of suffocation

- Do not leave the packaging or any part of it unattended.
- Do not let children play with the plastic bags.



## 1.7 How to read the user manual

This user manual uses the following reading conventions:

### Instructions



General information on this user manual, on safety and final disposal.

### Description



Description of the appliance and its accessories.

### Use



Information on the use of the appliance and its accessories, cooking advice.

### Cleaning and maintenance



Information for proper cleaning and maintenance of the appliance.

### Installation



Information for the qualified technician: Installation, operation and inspection.



Safety instructions



Information



Advice

1. Sequence of instructions for use.

- Standalone instruction.



## 2 Description

### 2.1 General description

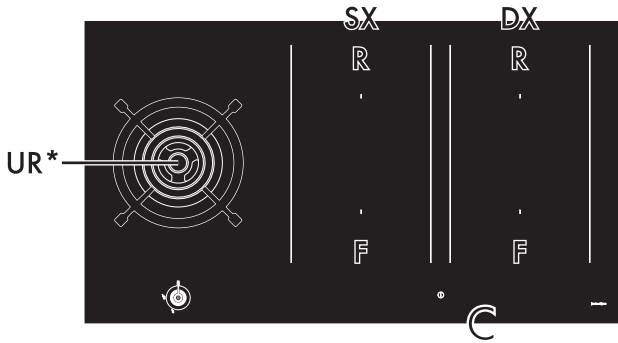

90 cm

**UR\*** = Ultra rapid

**SX** = Left induction cooking zone

**DX** = Right induction cooking zone

**F** = Front plate

**R** = Rear plate

**C** = General controls zone

### 2.2 Symbols

#### Burner knobs

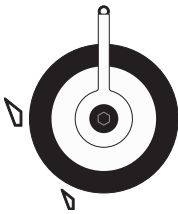

For lighting and adjusting the hob burners.

Press and turn the knobs anti-clockwise to in order to light the relative burners.

Turn the knobs to the zone between the maximum and minimum setting to adjust the flame. Return the knobs to the position to turn off the burners.

#### List of symbols

On/Off button: turns the hob on or off.

Pause button: pauses cooking.

Controls lock button: prevents accidental operation of controls.

Grill function button: activates the Grill function

Warming function button: activates the keep warm function.

Scroll bar: increases or decreases the power level of a cooking zone.





## Description

### Maximum absorbed power table (Watt)

	Dimensions H x L (mm)	Level 9	Booster	Double Booster
Single zone	180 x 240	2100 W	2500 W	3000 W
Multizone	360 x 240	3000 W	3700 W	-

\* power levels are approximate and may vary according to the pan used or the settings made.

### Advantages of induction cooking



The appliance is equipped with an induction generator for each cooking zone. Each generator located under the glass ceramic cooking surface creates an electromagnetic field which induces a thermal current in the base of the pan. This means the heat is no longer transmitted from the hob to the pan but created directly inside the pan by the inductive current.

- Energy saving thanks to the direct transmission of energy to the pan (suitable magnetisable cookware is required) compared to traditional electric cooking.
- Improved safety as the energy is only transmitted to the pan placed on the hob.
- High level of energy transmitted from the induction cooking zone to the base of the pan.
- Rapid heating speed.
- Reduced danger of burns as the cooking surface is only heated under the base of the pan; foods which overflow do not stick.

### Power control

The hob is fitted with a power control module that optimises/limits consumption. If the overall set power level exceeds the maximum limit permitted, the electronic circuit board will automatically manage the power supplied by the hot plates.

The module tries to maintain the maximum deliverable power levels. Levels set by the automatic control will appear on the display.



Priority is given to the last zone set.



The power control module does not affect the total power consumption of the appliance.



## 2.3 Available accessories

### Wok support

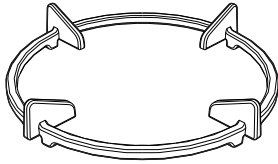

Useful when using a wok.

**i** The accessories intended to come into contact with food are made of materials that comply with the provisions of current legislation.

**i** Original supplied and optional accessories can be requested to Authorised Assistance Centres. Use only original accessories supplied by the manufacturer.



## 3 Use

### 3.1 Instructions



#### Improper use Danger of burns

- Make sure that the flame-spreader crowns are correctly positioned in their housings with their respective burner caps.
- Do not leave the appliance unattended during cooking operations where fats or oils could be released.
- Oils and fats could catch fire if overheated. Be very careful.
- Protect your hands by wearing heat-proof gloves during use.
- Do not touch or clean the hob surface during operation or when the residual heat indicator lights are still on.
- Do not put empty pans or frying pans on switched on cooking zones.
- Do not touch the appliance's heating elements when it is in operation. Leave them to cool before cleaning.
- Activate the controls lock when you have children or pets which could reach the hob.
- After use the cooking zones remain hot for a certain period of time after they have been turned off. Do not touch the hob surfaces.



#### Improper use Risk of damage to surfaces

- Do not use aluminium foil to cover the burners or hob body.
- Cooking vessels or griddle plates should be placed inside the perimeter of the hob.
- All pans must have smooth, flat bottoms.
- If any liquid does boil over or spill, remove the excess from the hob.
- It is not recommended to use earthenware or steatite (soapstone) pans to cook or heat food.
- Do not use the hob if the pyrolytic cycle is taking place inside any oven installed below.
- Avoid hard, solid objects falling on the cooking surface.
- Do not use the hob as a support surface.



#### High temperature Danger of fire or explosion

- Do not use or leave flammable materials near the appliance or directly underneath the hob.
- Do not cook in closed tins or containers, plastic kitchenware or containers.
- In case you notice cracks or fissures or you cannot turn off the appliance, disconnect the power supply and contact the Assistance Centre.



### 3.2 Precautions

#### A gas leak can cause an explosion.

If you smell gas or there are faults in the gas system:

- Immediately turn off the gas supply or close the valve on the gas cylinder.
- Extinguish all naked flames and cigarettes.
- Do not turn on power switches or appliances and do not remove plugs from power sockets. Do not use phones or mobile phones inside the building.
- Open the window in order to ventilate the room.
- Call customer assistance services or your gas supplier.

#### Malfunctions

Any of the following indicate a malfunction and you should contact a service centre.

- Damage to kitchen utensils.
- The burners do not ignite properly.
- It is difficult to keep the burners lit.
- The burners go out when the appliance is in use.
- It is difficult to turn the gas cocks.

If the appliance does not work properly, contact your local Authorised Service Centre.

### 3.3 First use

1. Remove any protective film from the outside or inside of the appliance, including accessories.
2. Remove any labels (apart from the technical data plate) from accessories.

3. Remove and wash all the appliance accessories (see 4 Cleaning and maintenance).

### 3.4 Using the gas burners

All the appliance's control and monitoring devices are located together on the front panel. The burner controlled by each knob is shown next to the knob. The appliance is equipped with an electronic ignition device. Simply press the knob and turn it anti-clockwise to the maximum flame symbol, until the burner ignites. If the burner does not light in the first 15 seconds, turn the knob to  and wait 60 seconds before trying again. After lighting, keep the knob pressed in for a few seconds to allow the thermocouple to heat up.

The burner may go out when the knob is released: In this case, the thermocouple has not heated up sufficiently. Wait a few moments and repeat the operation. Keep the knob pressed in longer.



In case of an accidental switching off, a safety device will be tripped, cutting off the gas supply, even if the gas cock is open.

Return the knob to  and wait at least 60 seconds before lighting it again.



## Correct positioning of the flame-spreader crowns and burner caps

Before lighting the hob burners, make sure that the flame-spreader crowns are correctly positioned in their housings with their respective burner caps. Make sure that the holes in the burners are aligned with the igniters and thermocouples. Also ensure that the flame-spreader crowns are correctly engaged in the burner holes.

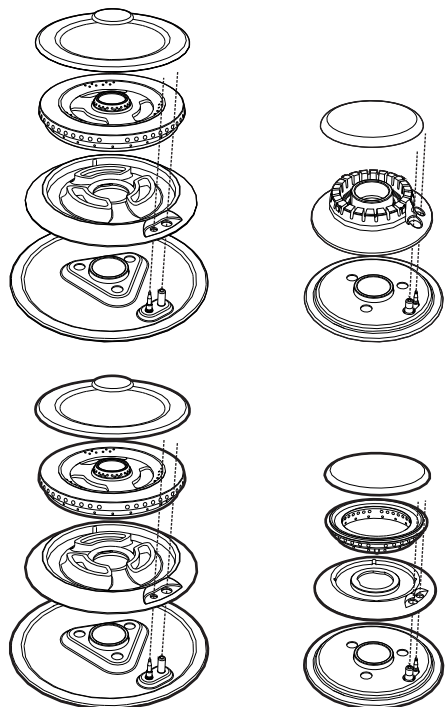

## Correct positioning of the pan supports

Under the pan supports there are silicone rests with a hole that must be centred onto the matching fixing pins on the surface.

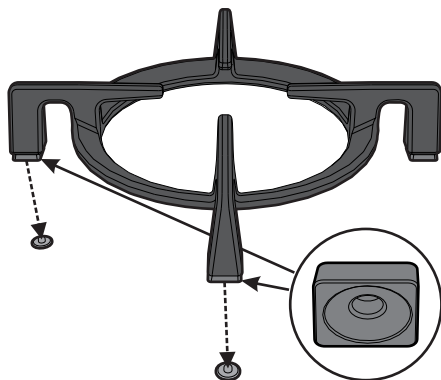

Make sure that the pan supports are simply centred on their respective burners, without forcing them to be raised or tilted. If they are, repeat the positioning procedure. If you find that a pan is particularly unstable, make sure that the grids have not been positioned incorrectly.

## Cookware diameters



- UR\*: from 20 to 30 cm.



### Trivets and reduction pan supports

The trivet/support must be rested on the hob pan supports. Make sure they are properly positioned.

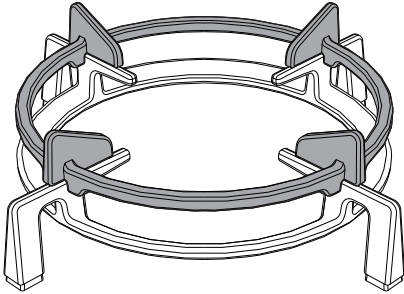

### Using a griddle

A few precautions are necessary if you wish to use a griddle:

- The griddle can be pre-heated with the burner on maximum power for no more than 10 minutes.
- It is recommended you reduce the power during cooking;
- Do not allow the burner flames to extend beyond the edge of the griddle;
- Leave a gap of at least 150 mm between the edge of the griddle and the side wall;
- Do not place the griddle over more than one burner at the same time.

### 3.5 Using the induction hot plates

All the appliance's control and monitoring devices are located together on the front panel. The induction hob is controlled by means of the Touch control sensor buttons. Lightly touch a symbol on the glass ceramic surface. A beep will sound to confirm every effective touch.

#### Switching on the hob for the first time

**i** On first connection to the electrical mains, an automatic check will be carried out that will switch on all indicator lights for a few seconds.

When the appliance is used for the first time, after having been connected to the

mains the flashing  symbol appears on the display. It is used to access the appliance's technical menu and is intended only for Technical Support personnel.

#### Cooking zones setting area



The buttons for selecting the cooking zones and the timer icons above each of them are located in this zone.

#### Timer setting area

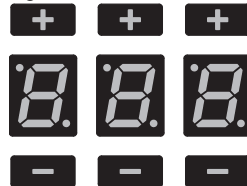

The controls for setting the independent timer and the timer for the cooking zones are located in this area.



## Use

### Minimum cookware diameter

Make sure that the minimum diameter of the pans are those indicated in the following table, for both configurations.

Configuration	Minimum Ø (cm)	Maximum Ø (cm)
Single plate	11	18
Multi-zone*	18	22

\*Values for one pan, if two pans are used refer to the values for a single hot plate configuration.

Bear in mind the following:

- Do not allow the pans to extend beyond the vertical lines.
- Do not cover the control panel.
- Do not place the pans next to the edges of the glass.
- If you use a griddle, it must be a maximum size of 36 x 24 cm and must anyway not be larger than the zones marked on the hob (see "Maximum absorbed power table (Watt)")

### Cookware suitable for use in induction cooking

Cookware used on the induction cooking surface must be made of metal, with magnetic properties and a sufficiently large base.

#### Suitable cookware:

- Enamelled steel cookware with thick bases.
- Cast iron cookware with an enamelled base.

- Cookware in multilayer stainless steel, ferritic stainless steel and aluminium with a special base.

#### Unsuitable cookware:

- Copper, stainless steel, aluminium, fireproof glass, wood, ceramic and terracotta cookware.

To see whether the pan is suitable, bring a magnet close to the bottom: if it is attracted, the pan is suitable for induction cooking.

If you do not have a magnet, you can put a small amount of water in the pan, place it on a cooking zone and start the hot plate.

If the  symbol appears on the display, it means the pan is not suitable.

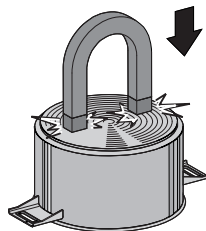

Use only cookware with a perfectly flat bottom which is suitable for induction hot plates. Using cookware with an irregular bottom could jeopardise the efficiency of the heating system and prevent cookware from being detected on the hot plate.



Make sure that the pans do not cover the control panel.



## Limiting the cooking duration

The hob has an automatic device which limits the duration of use.

If the cooking zone settings are not changed, the maximum duration of operation for each zone depends on the power level selected.

When the device for limiting the duration of use is activated, the cooking zone turns off, a short alert sounds and, if the zone is hot, the  symbol appears on the display.

Set power level	Maximum cooking duration in hours
1	6
2	6
3	5
4	5
5	4
6	1 ½
7	1 ½
8	1 ½
9	1 ½

## Protection from overheating

If the hob is used on full power for a long period, the electronics will have trouble cooling down if the room temperature is high.

If the temperature of the internal electronic components exceeds the safety threshold, the appliance will switch off automatically and "ER21" will be displayed (see "Error codes").

## Advice on energy-saving

- The diameter of the base of the pan must not exceed the width of the silk-screened cooking zone.
- Pans must not be placed outside the perimeter of the hob or above the front control panel.
- When buying a pan, check whether the diameter indicated is that of the base or the top of the pan, as the top is almost always larger than the base.
- When preparing dishes with long cooking times, you can save time and energy by using a pressure cooker, which also helps to retain vitamins contained in the food.
- Make sure that the pressure cooker contains enough liquid as, if there is not enough and it overheats, this may cause damage to both the pressure cooker and the cooking zone.
- If possible, always cover pans with a suitable lid.
- Choose a pan suitable for the quantity of food to be cooked. A large, half-empty saucepan leads to a waste of energy.





Under certain circumstances, if the hob and the oven are being used at the same time, the maximum power limit that can be used by the electrical system might be exceeded.



# Use

## Power levels

The power in the cooking zone can be adjusted to various levels. The table shows the levels suitable for various types of cooking.

Power level	Suitable for:
0	OFF setting
1 - 2	Cooking small amounts of food (minimum power)
3 - 4	Cooking
5 - 6	Cooking large quantities of food, roasting larger portions
7 - 8	Roasting, slow frying with flour
9	Roasting
P /  	Roasting / Browning, cooking (maximum power)*

\* see Booster and Double Booster function

## Switching the hob on and off

Keep the On/Off button  pressed in for at least 1 second to activate the hob. Press it again for at least one second to deactivate it.





If no power value is selected within a few seconds, the hob is automatically deactivated.

## Switching on the cooking zone automatically



The hob is provided with an automatic pan sensing system.

After switching on the hob:

- Position a pan (suitable for induction cooking and not empty) on the cooking zone you wish to use.
- The button corresponding to the zone on which the container has been placed turns on automatically and displays . The first segment of the scroll bar will light up.
- Select the cooking zone by pressing the corresponding button (see "Cooking zones setting area").
- Once a zone has been selected, a dot appears in the lower right corner of the digit field: the power level shown is .

## Adjusting the cooking zone

After selecting a cooking zone:

1. Place a finger on the left-hand side of the scroll bar of the cooking zone to be used.



The power level is now .



2. Move your finger to the left or right on the scroll bar to select the power level, from

**1** to **9** or activate the Booster function (see "Booster Function").

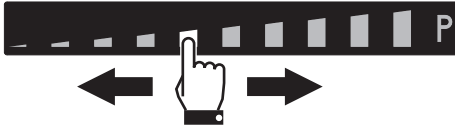

The display of the zone being used will indicate the selected power level.

### Switching off the cooking zone

1. Move your finger all the way to the left on the scroll bar of the cooking zone you wish to turn off.



The display of the zone being used

indicates **0**.



Hold the On/Off button  down for at least 2 seconds to switch off all cooking zones at the same time.

### Quick selection



This function allows you to quickly set the cooking zones to the required power.

After switching on the hob and having selected a cooking zone:

1. Place a finger on the scroll bar at approximately the required power level.



2. Move your finger to the left or right to select the required cooking power.

### Booster Function



**Improper use**  
**Danger of burns**

- Do not use the Booster and Double Booster functions to heat fats or oils as they could catch fire.



This function allows you to use the maximum available power of the cooking zone in order to bring a large amount of water to the boil rapidly.



## Use

After switching on the hob and having selected a cooking zone:

1. Place a finger on the left-hand side of the scroll bar.



The display of the cooking zone used will turn on: the power value indicated is .

2. Move your finger all the way to the right of the scroll bar to select the Booster function.

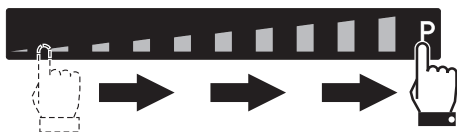

The display of the cooking zone used will show .

The Booster function can be activated quickly.



- After switching on the hob, place your finger at the far right of the scroll bar of the cooking zone you wish to use.



The Booster function remains active for a maximum of 5 minutes, after which the power is reduced automatically to level 9.

### Double Booster Function

The Double Booster function allows more power to be supplied compared to the Booster function.

After having activated the Booster function for a cooking zone, press "P" at the far right of the scroll bar. The symbols , , and  will be displayed in sequence.





## Multizone function

**i** This function can be used to operate two cooking zones (front and rear) when using pans like fish kettles or rectangular pans.

After switching on the hob:

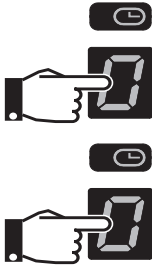
1. Place a finger simultaneously on the buttons of two cooking zones one above the other.



After a short beep, the  symbol will appear next to the button of the rear zone. The Multizone function is now active.

2. Use the left-hand scroll bar to set the required cooking power.

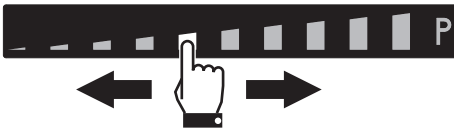

The same parameters are set on both cooking zones.



It is only possible to activate the Multizone function between cooking zones that are vertically connected (**F** and **R**).

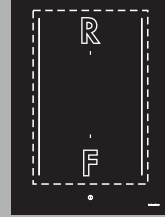

This function automatically divides the power equally between both of the hot plates in use.



It is not possible to activate the Double Booster function for the cooking zones on which the Multizone function is active.

If a large, oval or oblong pan is being used, make sure that it is placed in the centre of the cooking zone.

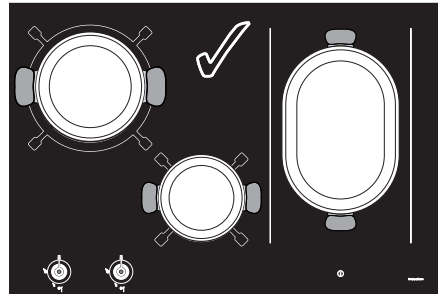

Example of correct pan position



## Use

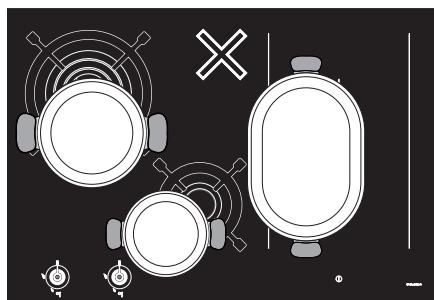

Example of incorrect pan position

### To deactivate the Multizone function:

Simultaneously press the buttons of the cooking zones on which the Multizone function is active. The  symbol

disappears and the two zones can be regulated separately.

### Cooking guidelines

The table below shows the power values which can be set, together with the corresponding type of food. Settings may vary depending on the amount of food and consumer taste.

Power level	Suitable for:
1 - 2	Reheating food, keeping small amounts of water on the boil, and whipping up sauces with egg yolk or butter.
3 - 4	Cooking solid or liquid food, keeping water on the boil, defrosting deep-frozen food, cooking 2- or 3-egg omelettes, fruit and vegetables, various cooking processes.
5 - 7	Stewing meat, fish and vegetables, simmering food, making jams etc.
8-9	Cooking or frying meat, fish, steaks and liver; browning meat, fish, eggs, etc.
P	Deep-frying potatoes, etc., or bringing water to the boil rapidly.

### Residual heat



#### Improper use Danger of burns

- Supervise children carefully as they cannot easily see the residual heat indicator. The cooking zones remain hot for a certain period of time even after they have been turned off. Make sure that children never touch the hob.

If the cooking zone is still hot after being switched off, the  symbol will be displayed on the display. The symbol clears once the temperature drops below 60°C.



## 3.6 Special functions

### Warning Function



This function allows you to keep cooked food warm or to keep water on the boil.

To activate the Warming function, first turn on the hob, then:

1. Select a cooking zone.
2. Press the button to activate the function. The symbol appears on the display of the selected cooking zone.

To deactivate the Warming function:

1. Select the cooking zone on which the function is active.
2. Press the button.

### Pause function



This function pauses the operation of all the cooking zones.

To activate the Pause function:

1. Switch on at least one cooking zone.
2. Hold down the pause button . appears on the displays of all the cooking zones.



The pause function can be maintained for a maximum of 10 minutes, after which the appliance switches off.

To deactivate the Pause function:

1. Hold down the button . The pause symbol, which has just been pressed, starts to flash.
2. Press any button apart from the Pause button
3. The pause function has now been deactivated and the previously set functions are restored.



The cooking time limitation, the residual heat indicators and the control lock function remain enabled during the Pause function.



When the power comes back on after a power failure, the pause function will be deactivated.

### Grill Function





- This function is used to activate the Multizone function automatically for the induction hot plates. It is used when using a griddle or cooking with long pans.
- For 90 cm models, the Grill function is only for the left hand side induction zones.

To activate the Grill function:

1. Place a griddle or a long pan on the left zones.
2. Press the button.



## Use

The  symbol appears on the front zone display and the  symbol appears on the rear zone display. The scroll bar will be set automatically to level **8**. (preheating stage)



After two minutes of operation, the power will be reduced to level **6**.

Press the  button and use the scroll bar to modify the power level at any time.

### Controls lock





This function allows you to disable all the buttons of the appliance.

This is useful when cleaning the appliance and to prevent functions being activated by mistake.

To activate the control lock:

- Press the  button for at least one second.

All the buttons, apart from the  and  buttons, are locked.

To deactivate the control lock:

1. press the  button again for at least one second.

## 3.7 Additional functions

### Rapid heating



This function is not available for power level **9** or the Booster and Double booster functions.

The rapid heating function heats one cooking zone at maximum power for a limited time, after which it continues cooking at the set power level.

After selecting a cooking zone:

- Press and hold a power level (from **1** to **8**) for at least 3 seconds.
-  appears on the display of the cooking zone.
- After the heating time has elapsed, the cooking zone reverts to the previously selected power level.

This function can be deactivated by pressing and holding the set power level for at least 3 seconds, or by selecting a lower power level.

### Timer



This function is used to set a timer that will emit a sound at the end of the pre-set time.

After having switched on the hob, without having selected a cooking zone:

1. Touch the inside of the timer setting area.





2. Use the **+** and **-** buttons to select the required time.

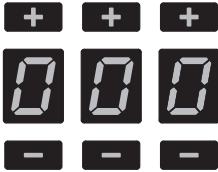

- The first digit on the left is used to select the hours, the middle one to set the tens of minutes and the one on the right the minutes.



After switching on the appliance, touch the timer setting area within 3 seconds, otherwise it will deactivate and the appliance will have to be restarted.

- After 10 seconds, the timer will start the countdown.
- When the time elapses, a series of beeps will sound. Press any button to deactivate them.



A maximum of 9 hours and 59 minutes can be set.



Using the minute minder does not stop the operation of the cooking zones but rather informs the user when the set minutes have run out.

## Modifying or deactivating the timer

To modify or deactivate the timer during the countdown:

- Press the On/Off button to activate the hob (if it is in stand-by).
  - The timer setting area will indicate the minutes that were set.
- Use the **+** and **-** buttons to modify or reset the timer.
- After 10 seconds, the timer will start the new countdown or will be deactivated.

## Timed cooking



This function is used to program the automatic switch-off of each cooking zone at the end of a period of time.

The timed cooking function can be activated when at least one cooking zone is switched on:

- Select a power level.
- Touch the inside of the timer setting area.



- The flashing symbol will appear above the cooking zone display.
- Use the **+** and **-** buttons to select the required time.



- Timed cooking will start a few seconds after the last selection.



## Use

At the end of the set time, a buzzer tells the user that the Minute minder has finished.

5. Press any button to deactivate the buzzer.



A maximum of 9 hours and 59 minutes can be set.



This function can be activated on multiple cooking zones at the same time. The flashing LED and time indicator refer to the next cooking zone to be switched off.

### Modifying or deactivating timed cooking

To modify timed cooking during the countdown:

1. Press the On/Off button  to activate the hob (if it is in stand-by).
2. Press the display button of the timed cooking zone.
  - The timer setting area will indicate the minutes that were set.
3. Use the + and - buttons to modify or reset the timer.
4. After 10 seconds, the timer will start the new countdown or will be deactivated.





An independent timer can be set during timed cooking.

### Recall Function



This is used to restore some functions that have already been started after the appliance has been switched off unintentionally.

If the appliance is switched off unintentionally, carry out the following procedure within 6 seconds:

1. Switch on the appliance.
  - The  button starts to flash.
2. Press the pause button  immediately to restore the functions that were previously active.



This function restores the cooking zones, timer and rapid heating functions; no other functions will be restored.



### 3.8 User menu

The user menu is used to modify the operating characteristics of the appliance. 7 options in the user menu can be modified. Each option is indicated on the display with the letter "U", which alternates with a progressive number.

Option	Description
U0	Maximum total power (kW)
U1	Option not selectable
U2	Button volume
U3	Buzzer volume
U4	Display brightness
U5	Timer animation
U6	Automatic pan detection
U7	Timer alarm duration



## Accessing the user menu

1. If the hob is off, switch it on using the On/Off button .
2. Press  again within 3 seconds to switch it off; the  button starts to flash.

Press and hold .

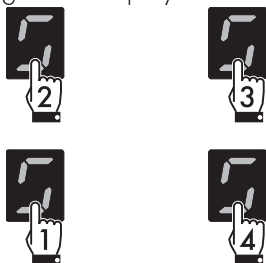

3. The following will be shown on the cooking zones display:



4. Press all the buttons of the cooking zones in sequence in a clockwise direction starting from the front left. Every effective touch will be confirmed by a beep.

**i** If the sequence of the buttons is selected incorrectly, the hob will be deactivated and the procedure for accessing the menu will have to be repeated.

5. Release the  button.

The user menu is active and the  symbol alternating with the number  (option **U0** - Function **Eco-Logic Advance**) will appear at the top of the cooking zones display. The Eco-Logic Advance function allows to increase or decrease appliance total power by 0.1 kW steps.

The timer display on the other hand will indicate the default power setting (according to the model - see "Table of power draws"):



Press the timer setting area to enable changes to the power settings. Then press the left half of the scroll bar to decrease the power or the right half to increase it.

## Table of power draws

Model	Minimum power (kW)	Maximum power (kW)
90 cm	2.4	7.4

- Press the  symbol to go back to selecting the options.
- Press the segments of the scroll bar to select an option.



Each segment of the scroll bar corresponds to an item in the user menu, except for the second segment from the left (**U1**), which is deactivated.

Option **U2** modifies the volume of the button sounds; 4 sound levels can be selected using the scroll bar.



According to the adjustment range of each option, the scroll bar will show only those segments that correspond to the adjustments available for each option.



## Use

- **0**: minimum volume.
- **3**: maximum volume.



The sound associated with the  button and the sounds associated with error messages cannot be deactivated.

Option **U3** modifies the volume of the signals (for example the sound of the alarm when the timer has finished). 4 levels can be selected.

- **0**: minimum volume.
- **3**: maximum volume.

Option **U4** modifies the brightness of the display. 10 levels can be selected.

- **0**: maximum brightness.
- **9**: minimum brightness.

Option **U5** allows you to display the countdown of the minute minder timer and timed cooking in seconds, from 59 to 0 seconds.



The seconds count is displayed when the timer is set for less than 10 minutes.

- **0**: animation off.
- **1**: animation on.

Option **U6** allows you to activate or deactivate the automatic pan detection function. (see "Switching on the cooking zone automatically").

- **0**: automatic detection off.
- **1**: automatic detection on.



If automatic pan detection is disabled, the area must be switched on manually when a pan is placed on the hob.

Option **U7** specifies the length of the alarm when the timer has finished. 3 levels can be selected:

- **0**: alarm duration 120 seconds.
- **1**: alarm duration 10 seconds.
- **2**: alarm disabled.

### Exiting the user menu

There are two ways to exit from the user menu:

1. Press the  button. Any modifications will be discarded and the hob will be switched off.

Or

2. Press and hold the On/Off  button for at least 2 seconds. The modifications will be saved and the hob will be switched off.

### 3.9 Error codes

If the appliance malfunctions or operates incorrectly, the associated error code appears on the cooking zones display.

The error codes always begin with "E.." or "Er..", followed by a number.

The following error codes can be corrected without having to contact the Technical Support Service.

- **Er03**: Remove any materials or pans from the area of the front control panel.
- **E2**: Make sure that the pans are suitable for induction cooking and that they are not empty; allow the appliance to cool down.



If these error codes appear frequently, contact Technical Support.

For all other errors, make a note of the code, if possible, and contact Technical Support.



### 3.10 Practical advice

- For better burner efficiency and to minimise gas consumption, use pans with lids and of suitable size for the burner, so that the flames do not reach up the sides of the pan. Once the contents come to the boil, turn down the flame far enough to ensure that the liquid does not boil over.
- To prevent burns or damage to the hob or the counter top during cooking, all pans or griddles (not supplied) must be placed inside the perimeter of the hob.

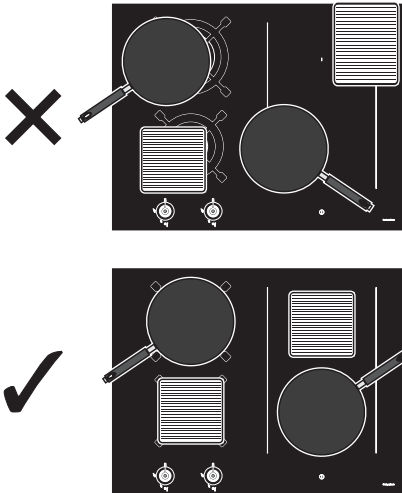

- The diameter of the base of the pan must not exceed the width of the silk-screened cooking zone.
- Pans must not be placed outside the perimeter of the hob or above the front control panel.
- When buying a pan, check whether the diameter indicated is that of the base or the top of the pan, as the top is almost always larger than the base.
- When preparing dishes with long cooking times, you can save time and energy by using a pressure cooker, which also helps to retain vitamins contained in the food.
- Make sure that the pressure cooker contains enough liquid as, if there is not enough and it overheats, this may cause damage to both the pressure cooker and the cooking zone.
- If possible, always cover pans with a suitable lid.
- Choose a pan suitable for the quantity of food to be cooked. A large, half-empty saucepan leads to a waste of energy.



Under certain circumstances, if the hob and the oven are being used at the same time, the maximum power limit that can be used by the electrical system might be exceeded.



## 4 Cleaning and maintenance

### 4.1 Instructions



**Improper use**

**Risk of damage to surfaces**

- Do not use steam jets to clean the appliance.
- Do not use cleaning products containing chlorine, ammonia or bleach on parts made of steel or that have metallic surface finishes (e.g. anodizing, nickel- or chromium-plating).
- Do not use abrasive or corrosive detergents (e.g. scouring powders, stain removers and metallic sponges) on glass parts.
- Do not use rough or abrasive materials or sharp metal scrapers.
- Do not wash removable parts such as the hob pan support grids, flame-spreader crowns and burner caps in the dishwasher.
- Do not use steam jets to clean the appliance.
- Do not spill sugar or sweet mixtures on the hob during cooking.
- Do not place materials or substances that could melt (plastic or aluminium foil).
- Keep sensor buttons clean at all times and do not rest any object on them.

### 4.2 Cleaning the appliance

To keep the surfaces in good condition, they should be cleaned regularly after use. Let them cool first.

#### Ordinary daily cleaning

Always and only use specific products that do not contain abrasives or chlorine-based acids.

Pour the product onto a damp cloth and wipe the surface, rinse thoroughly and dry with a soft cloth or a microfibre cloth.

Clean and maintain the hob once a week using an ordinary glass cleaning product. Always follow the manufacturer's instructions. The silicon in these products creates a protective, water-repellent membrane which also resists dirt. All marks stay on the membrane and can therefore be removed easily. After cleaning, dry the surface with a clean cloth. Make sure that there is no detergent left on the cooking surface as it will undergo a corrosive reaction when heated up and could modify the structure of the cooking surface.



## Food stains or residues

Do not use steel sponges and sharp scrapers as they will damage the surface.

Use normal, non-abrasive products and a wooden or plastic tool, if necessary. Rinse thoroughly and dry with a soft cloth or a microfibre cloth.

Do not allow residues of sugary foods (such as jam) to set inside the oven. If left to set for too long, they might damage the enamel lining of the oven.

Light coloured marks from pans with aluminium bases can be easily cleaned off with a cloth moistened in vinegar.

Remove any burnt-on residues after cooking; then rinse with water and dry thoroughly with a clean cloth.

**Dirt** which may have fallen on the hob while cleaning lettuce or potatoes can scratch the hob when moving pans.

Consequently, remove any dirt from the cooking surface immediately.

**Changes in colour** do not affect the operation and stability of the glass. These are not alterations to the material of the hob but just residues which have not been removed and have then carbonised.

**Shiny surfaces** can form due to the bases of pans, especially aluminium ones, rubbing on the surface, and due to the use of unsuitable detergents. They are difficult to remove using conventional cleaning products. It may be necessary to repeat the cleaning process several times. Use of corrosive detergents or rubbing of pan bases can wear away the decoration on the hob over time and contribute to the formation of stains.

## Cooking hob pan support grids

Remove the pan support grids and clean them in lukewarm water and non-abrasive detergent. Make sure to remove any encrustations. Dry them thoroughly and return them to the hob.



The continuous contact between the pan supports and the flame can cause modifications to the enamel over time in those parts exposed to heat. This is a completely natural phenomenon which has no effect on the operation of this component.



## Cleaning and maintenance

### Flame-spreader crowns and burner caps

For easier cleaning, the flame-spreader crowns and the burner caps can be removed. Wash them in hot water and non-abrasive detergent. Carefully remove any encrustation, then wait until they are perfectly dry. Replace the flame-spreader crowns, making sure that they are correctly positioned in their housings with their respective burner caps.

### Igniters and thermocouples

For correct operation the igniters and thermocouples must always be perfectly clean. Check them frequently and clean them with a damp cloth if necessary. Remove any dry residues with a wooden toothpick or a needle.

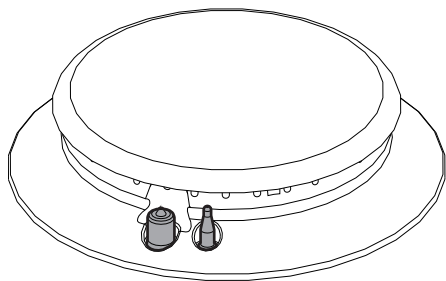

### 4.3 What to do if...

The hob does not work:

- Make sure that the hob is connected and that the main switch is turned on.
- Make sure that there is no power failure.
- Make sure that the fuse has not blown. In this case replace the fuse.
- Make sure that the circuit breaker of the residential electrical system has not tripped. In this case, reset the circuit breaker.

The cooking results are unsatisfactory:

- Make sure that the cooking temperature is not too high or too low.

The hob smokes:

- Let the hob cool down and clean it once cooking is complete.
- Make sure that the food has not spilled out of the pan and use a larger cooking vessel, if needed.

The fuses blow or the circuit breaker of the residential electrical system trips repeatedly.

- Call Technical Support or an electrician.

There are cracks or fissures in the hob:

- Turn off the appliance immediately, disconnect the power supply and contact Technical Support.



## 5 Installation

### 5.1 Minimum clearance to combustible surface

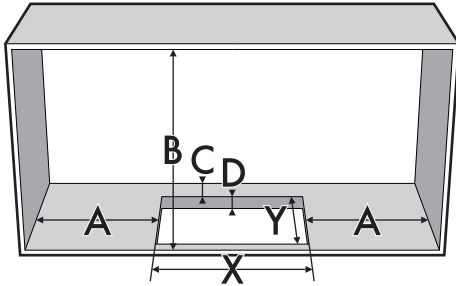

- A** 200mm (Vertical combustible surface)
- B** 600mm (Overhead) measured from the highest part of the highest burner and 750mm for an exhaust fan.
- C** 65mm (non-combustible surface)
- D** 20mm (benchtop)
- X** (width) & **Y** (depth) see appliance dimension within this manual.

Refer to AS/NZS 5601 (Protection of a combustible surface) if the above minimum clearances cannot be achieved.  
The top of the pan support is 62mm above the bench top.

### Appliance dimensions (mm)

Position of gas and electrical connections.  
(seen from below)

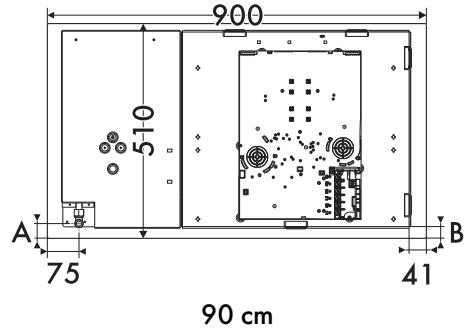

<b>A</b>	<b>35</b>
<b>B</b>	<b>28</b>

### 5.2 Mounting

#### Over empty kitchen unit or drawers

If there are other pieces of furniture (lateral walls, drawers, etc.), dishwashers or fridges under the hob, a double-layer wooden base must be installed at least **20 mm** from the bottom of the hob to avoid any accidental contact. It must only be possible to remove the double-layer base using suitable equipment.

#### Over built-in oven unit

The clearance between the hob and the kitchen furniture or other installed appliances must be enough to ensure sufficient ventilation and air discharge. If installed above an oven, a space must be left between the bottom of the hob and the top of the appliance installed below.



# Installation

## 5.3 Section cut from the work surface



The following operation requires building and/or carpentry work and must therefore be carried out by a competent tradesman. Installation can be carried out on various materials such as masonry, metal, solid wood or plastic laminated wood as long as they are heat resistant (>90°C).

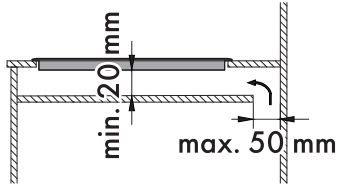

opens on bottom

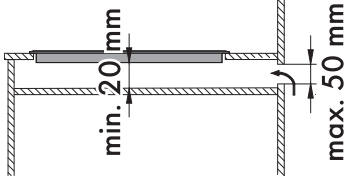

opens on rear

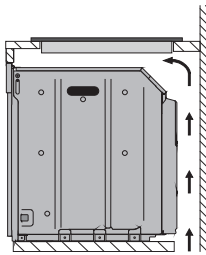

opens on bottom

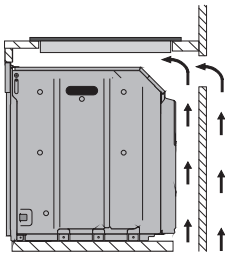

opens on bottom and on rear

### Flush mounted installation

Make a hole in the countertop of the unit according to the dimensions shown in the figure (mm).

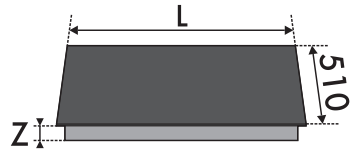

L	X	Y	Z
900	844 - 848	482 - 486	46

After laying the adhesive seal (A) on the glass surface and after positioning and securing the hob, fill the edges with insulating silicone (B) and wipe away any excess.

In the event the hob needs to be removed, cut the silicone using a cutter before attempting to remove it (C).

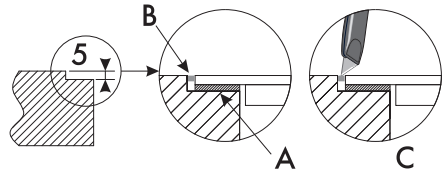



## Flush mounting dimensions (mm)

1 = Gas connection

2 = Electrical connection

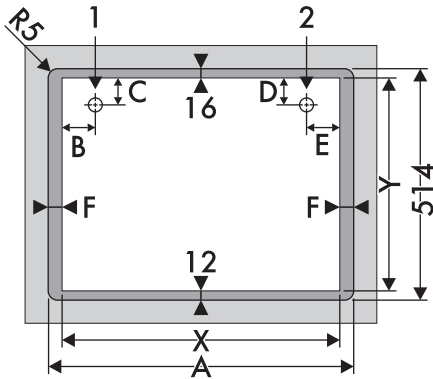

A	B	C	D	E	F
904	75	35	70	112	29

## Semi-flush installation

Make a hole in the countertop of the unit according to the dimensions shown in the figure (mm).

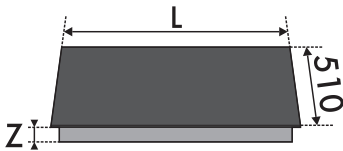

L	X	Y	Z
900	839 - 844	482 - 486	46

## Semi-flush mounting dimensions (mm)

1 = Gas connection

2 = Electrical connection

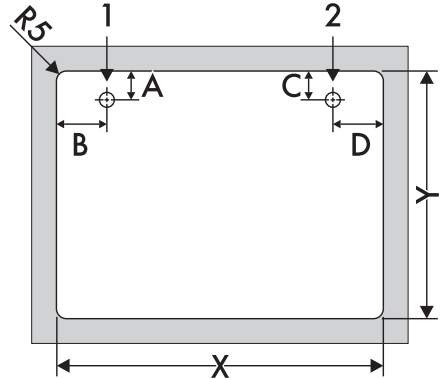

L	A	B	C	D
900	35	75	70	112

## Hob seal

### With glass hob

To prevent leakage of liquid between the frame of the hob and the countertop, place the adhesive seal provided along the entire outer edge of the hob before assembly.

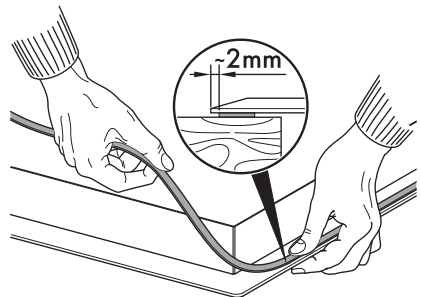



# Installation

## Spring clips

To ensure the hob is fixed and centred as accurately as possible, the clips provided must be positioned as described below:

1. Fit the clips by gently pressing them horizontally into the appropriate space.

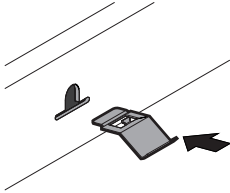

2. Then turn them upwards to fix them in place.

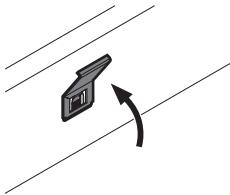

## Position of slot for clips

(seen from below)

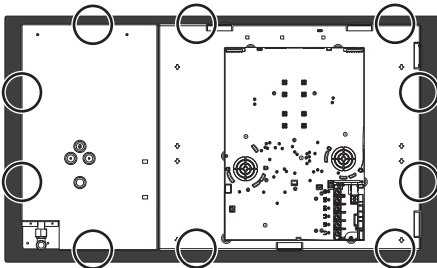

90 cm

## Ventilation

The illustrations below show two examples of installation suitable for proper ventilation and one example of incorrect installation to be avoided.

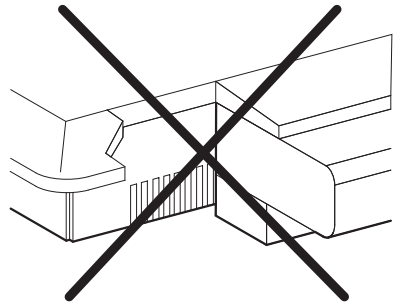
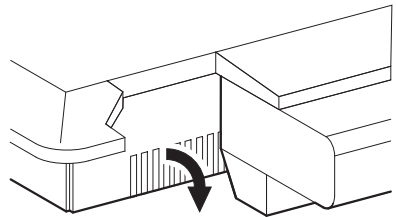
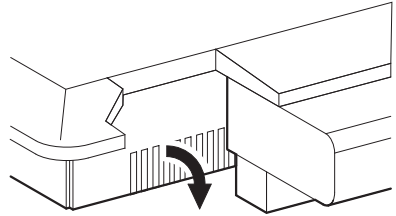



## Room ventilation

The appliance should be installed in rooms that have a permanent air supply in accordance with the standards in force. The room where the appliance is installed must have enough air flow for the regular combustion of gas and the necessary air change in the room itself. The air vents, protected by grilles, must be the right size to comply with current regulations and positioned so that no part of them is obstructed, not even partially.

The room must be kept adequately ventilated in order to eliminate the heat and humidity produced by cooking: In particular, after prolonged use, you are recommended to open a window or to increase the speed of any fans.

## Extraction of the combustion products



This domestic appliance is not connected to a device for extracting combustion products. It must be installed and connected in accordance with current installation regulations. Pay particular attention to the relevant requirements regarding ventilation.

The combustion products may be extracted by means of hoods connected to a natural draught chimney whose efficiency is certain or via forced extraction. An efficient extraction system requires precision planning by a specialist qualified in this area and must comply with the positions and clearances indicated by the applicable standards.

When the job is complete, the installer must issue a certificate of conformity.

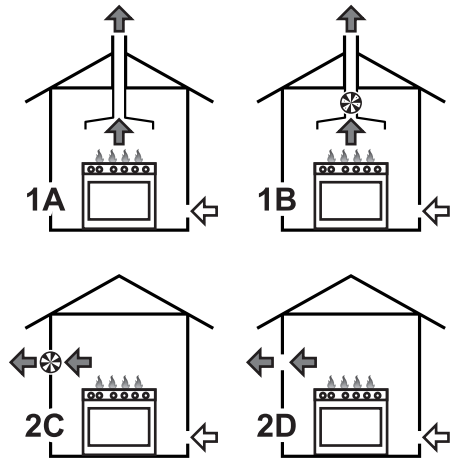

- 1 Extraction using a hood
- 2 Extraction without a hood
- A Single natural draught chimney
- B Single chimney with extractor fan
- C Directly outdoors with wall- or window-mounted extractor fan
- D Directly outdoors through wall
- ↔ Air
- ← Combustion products
- ⊗ Extractor fan



# Installation

## 5.4 Gas connection



**Gas leak  
Danger of explosion**

- After carrying out any operation, check that the tightening torque of gas connections is between 10 Nm and 15 Nm.
- If required, use a pressure regulator that complies with current regulations.
- At the end of the installation, check for any leaks with a soapy solution, never with a flame.
- Installation with flexible hose must be carried out so that the length of the piping does not exceed 1,2 metres when fully extended; make sure that the hoses do not come into contact with moving parts and that they are not crushed in any way.
- The hoses should not come into contact with moving parts and should not be crushed in any way.
- The settings for this domestic appliance are shown on the gas setting label.

Carefully screw the connector **3** to the appliance's gas connector **1** (1/2" thread ISO 228-1), placing the supplied seal **2** between them.

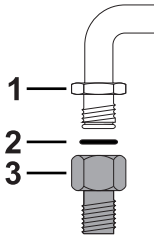

This appliance must be installed by an authorised person in accordance with the instruction manual, AS/NZS 5601 - Gas installations (installation and pipe sizing), local gas fitting regulations, local water regulations, local electric regulations, local health regulations, Building Code of Australia and any government authority.

This appliance is suitable for connection with rigid pipe or flexible hose. The isolating manual shut-off valve connection point must be accessible when the appliance is installed.

Flexible hose assembly must be certified to AS/NZS 1869 class B or D, be of appropriate internal diameter for the total gas consumption (10mm), be kept as short as possible (not exceeding 1200mm), must not be in contact with the floor or any hot surface. The hose assembly must not be subject to strain, abrasion, kinking, deformation, contact with any other appliance or accidental contact with oven flue outlet of an under bench oven.

**Natural Gas:** the pressure regulator must be fitted to the appliance inlet connection. Gas pressure must be adjusted to 1.0 kPa when approximately 50% of the burners are on high flame, the appliance test point is located on the regulator.

**ULPG:** the supplied test point adaptor must be fitted to the appliance inlet connection. Gas pressure must be checked to 2.75 kPa when approximately 50% of the burners are on high flame.



Gas leakage and operation of the appliance must be tested by the installer before leaving.

Check burner flames are blue in colour, stable and completely ignite at both high and low flame settings with no appreciable yellow tipping, carbon deposition, lifting, floating, lighting back or objectionable odour.

Test burners individually and in combination, when satisfied with the operation of the cooker, please instruct the user on the correct method of operation.

## 5.5 Adaptation to different types of gas

If other types of gas are to be used, the nozzles must be replaced and the primary air must be adjusted. The top of the hob has to be removed in order to replace the nozzles and adjust the burners.



In order to be able to replace the nozzles, the appliance must be removed from the built-in unit.

### Removing the hob top

1. Pull the knobs and the knob bezels (where present) upwards to remove them.

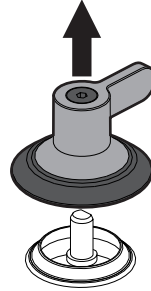

Between knob and knob bezel (depending on the model) there is a spring that is not shown in the figure.

2. Remove the pan support grids from the hob.

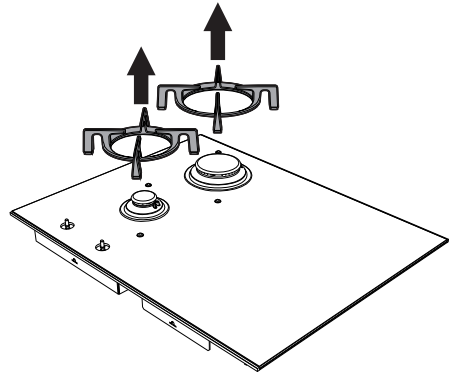



## Installation

3. Remove the flame-spreader crowns and relative burner caps.

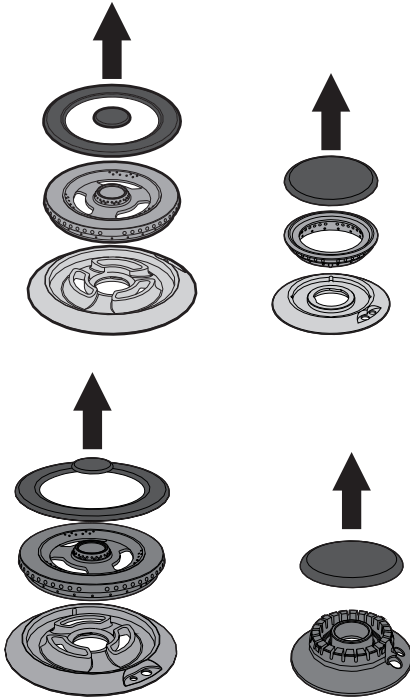

4. Remove the screws fastening the hob and the plates corresponding to each burner zone.

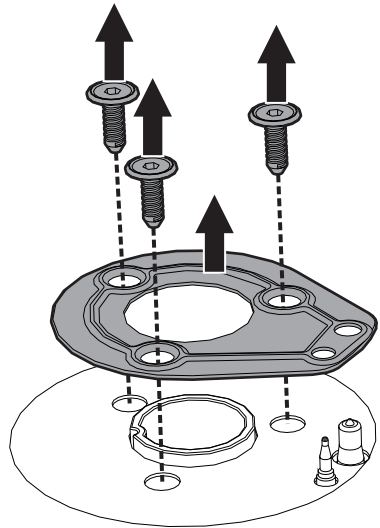

Where the UR burner is present, the nut that fixes the thermocouple to the hob top must be unscrewed (CH8).



Under the plates, there may be a number of seals, together with the igniter and thermocouple. Pay attention.



5. Unscrew the 6 screws that hold the glass hob top to the casing (see the figures below for their location).

(seen from below)

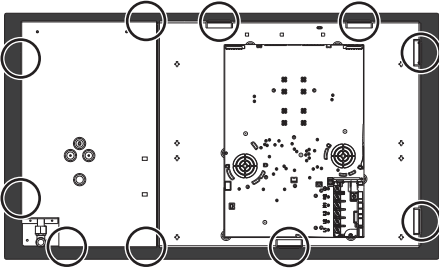

90 cm

6. Remove the glass hob top.

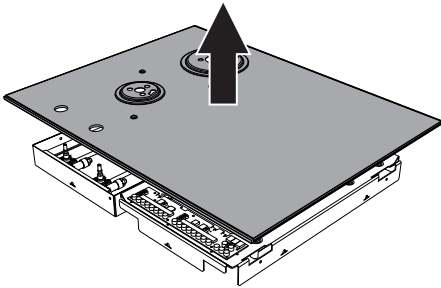

## Replacing the nozzles

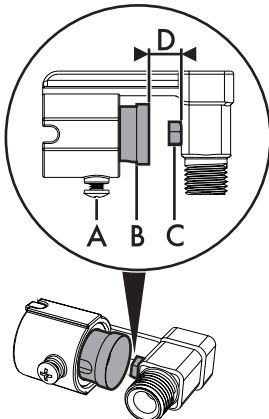

1. Unscrew screw **A** and push air regulator **B** as far as it will go.
2. Use a spanner to remove the nozzles **C** and install the new ones for the required gas supply, following the indications given in the relevant table (see "Burner and nozzle specifications tables").



The nozzle tightening torque must be no more than 3 Nm.

3. Adjust the air flow by moving the air regulator **B** to obtain the distance **D** given in the corresponding table (see "Burner and nozzle specifications tables").
4. After adjusting each burner, reassemble the appliance correctly.

## Adjusting the minimum setting for natural or town gas

1. Light the burner and turn it to the minimum position.
2. Extract the gas cock knob and turn the adjustment screw next to the gas cock spindle (depending on the model) until the correct minimum flame is achieved.
3. Refit the knob and verify that the burner flame is stable.
4. Turn the knob rapidly from the maximum to the minimum setting: The flame should not go out.



# Installation

5. Repeat the operation on all gas cocks.

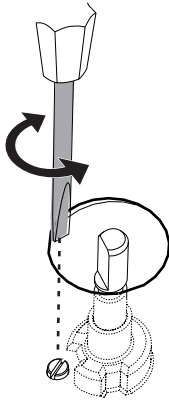

## Adjusting the minimum setting for LPG

Tighten the screw located at the side of the cock spindle clockwise all the way.



Following adjustment to a gas other than the one originally set in the factory, replace the gas setting label on the appliance with the one corresponding to the new gas. The label is inserted inside the nozzle pack (where present).

## Lubricating the gas cocks

Over time the gas cocks may become difficult to turn and get blocked. Clean them internally and replace the lubrication grease.



Lubrication of the gas cocks should be performed by a specialised technician.

## Re-assembling the hob top

Once the nozzles have been replaced, reassemble the glass hob top as follows:

1. With reference to the gas burners, replace the glass hob top on the casing.
2. For each burner, reposition the seals on the igniter and thermocouple.
3. Reposition the plates on the corresponding burners and secure with the 3 screws (for each burner) that had previously been removed.
4. If present, tighten the nut on the UR burner igniter.
5. Fix the glass hob top to the casing using the 6 screws that had previously been removed (see point 5 of section "Removing the hob top" for their location).
6. Fit the appliance into the cabinet.
7. Reposition the flame-spreader crowns and burner caps on the relative burners.
8. Reposition the grids on the glass hob top.
9. Reposition the knobs and knob bezels (where present) on the tap rods.



## Burner and nozzle specifications tables

NG 1.0 kPa		UR*
Nominal gas consumption (MJ/h)		21.6
Injector (1/100 mm)		220
Reduced flow rate (MJ/h)		6.5
Primary air (mm) 'D'		14
ULPG 2.75 kPa		UR*
Rated heating capacity (MJ/h)		21.6
Nozzle diameter (1/100 mm)		125
Reduced flow rate (MJ/h)		6.5
Primary air (mm) 'D'		10

The nozzles not provided are available at Authorised Service Centres.

## 5.6 Electrical connection



**Power voltage  
Danger of electrocution**

- Have the electrical connection performed by authorised technical personnel.
- Use personal protective equipment.
- The appliance must be connected to earth in compliance with electrical system safety standards.
- Disconnect the mains power supply.
- Do not pull the cable to unplug the appliance.
- Use cables withstanding a temperature of at least 90°C.
- The tightening torque of the screws of the terminal supply wires must be 1.5 - 2 Nm.
- **If it is necessary to replace the power cable, this must only be performed by a qualified technician.**

## General information

Check the grid characteristics against the data indicated on the plate.

The identification plate bearing the technical data, serial number and brand name is visibly positioned on the appliance.

Do not remove this plate for any reason.

Perform the ground connection using a wire that is 20 mm longer than the other wires.

The appliance can work in the following modes:

- **220-240 V / 380-415 V 2N~**

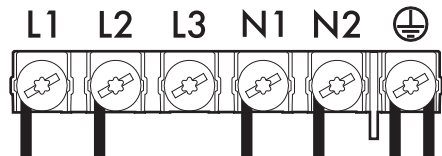

**6 x 1.5 mm<sup>2</sup> six-core cable.**



# Installation

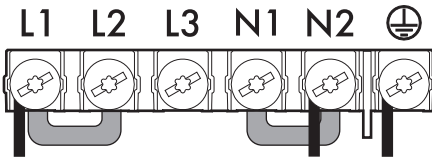

**3 x 6 mm<sup>2</sup> three-core** cable.



The values indicated refer to the cross-section of the internal conductor.

The diagram below illustrates the power supply terminal from below, with no cables connected. Terminals **4** and **5** must be connected at all times.

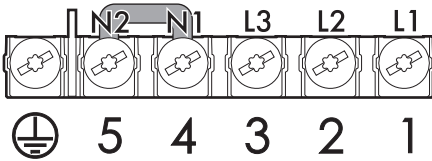

## Fixed connection

Fit the power line with an all-pole circuit breaker in compliance with installation regulations.

The circuit breaker should be located near the appliance and in an easily reachable position.

For stationary appliances permanently connected to the fixed wiring, compliance with this requirement is considered to be met if the instructions concerning disconnection incorporated in the fixed wiring is in accordance with AS/NZS3000.

## Connection with plug and socket (>16A)

Make sure that the plug and socket are of the same type.

Avoid using adapters and shunts as these could cause overheating and a risk of burns.



Run the power cable in the rear part of the unit. Make sure that it does not come into contact with the lower part of the hob or a built-in oven below it.



Be careful when connecting additional electrical appliances. Connection cables must not come into contact with hot cooking zones.

## Testing

At the end of installation, carry out a brief inspection test. If the hob fails to operate, after checking that you have carried out the instructions correctly, unplug the appliance and contact Technical Support.



## 5.7 Instructions for the installer

- The plug must be accessible after installation. Do not bend or trap the power cable.
- The appliance must be installed according to the installation diagrams.
- Do not try to unscrew or force the threaded elbow of the fitting. You may damage this part of the appliance, which may void the manufacturer's warranty.
- Use soap and water to check for gas leaks on all connections. **DO NOT** use naked flames to find leaks.
- Turn on all the burners separately and at then all together to make sure that the gas valve, burner and ignition are working properly.
- Turn the burner knobs to the minimum position and check that the flame is stable for each individual burner and all the burners together.
- If the appliance does not work correctly after having carried out all the checks, contact your local Authorised Service Centre.
- Once the appliance has been installed, please explain to the user how to use it correctly.



914779447/B