



DRAPER[®]

STORMFORCE

10.8V

COMBI DRILL

16048



These instructions accompanying the product are the original instructions. This document is part of the product, keep it for the life of the product passing it on to any subsequent holder of the product. Read all these instructions before assembling, operating or maintaining this product.

This manual has been compiled by Draper Tools describing the purpose for which the product has been designed, and contains all the necessary information to ensure its correct and safe use. By following all the general safety instructions contained in this manual, it will ensure both product and operator safety, together with longer life of the product itself.

All photographs and drawings in this manual are supplied by Draper Tools to help illustrate the operation of the product.

Whilst every effort has been made to ensure the accuracy of information contained in this manual, the Draper Tools policy of continuous improvement determines the right to make modifications without prior warning.

1. TITLE PAGE

1.1 INTRODUCTION:

USER MANUAL FOR:10.8V Combi Drill

Stock No:16048

Part No:CHD108SF

1.2 REVISIONS:

Date first published April 2019.

Revised date October 2019.

Revised date September 2020.

As our user manuals are continually updated, users should make sure that they use the very latest version.

Downloads are available from: <http://drapertools.com/manuals>

Draper Tools Limited
Hursley Road
Chandler's Ford
Eastleigh
Hampshire
SO53 1YF
UK

Website: drapertools.com

Product Helpline: +44 (0) 23 8049 4344

General Fax: +44 (0) 23 8026 0784

1.3 UNDERSTANDING THIS MANUALS SAFETY CONTENT:

WARNING! – Information that draws attention to the risk of injury or death.

CAUTION! – Information that draws attention to the risk of damage to the product or surroundings.

1.4 COPYRIGHT © NOTICE:

Copyright © Draper Tools Limited.

Permission is granted to reproduce this publication for personal and educational use only. Commercial copying, redistribution, hiring or lending is prohibited.

No part of this publication may be stored in a retrieval system or transmitted in any other form or means without written permission from Draper Tools Limited.

In all cases this copyright notice must remain intact.

2. CONTENTS

1	TITLE PAGE	
1.1	INTRODUCTION	2
1.2	REVISION HISTORY	2
1.3	UNDERSTANDING THIS MANUAL	2
1.4	COPYRIGHT NOTICE	2
2	CONTENTS	
2.1	CONTENTS.....	3
3	WARRANTY	
3.1	WARRANTY.....	4
4.	INTRODUCTION	
4.1	SCOPE.....	5
4.2	SPECIFICATION.....	5
4.3	HANDLING & STORAGE.....	6
5.	HEALTH AND SAFETY INFORMATION	
5.1	GENERAL POWER TOOL SAFETY WARNINGS.....	7-8
5.2	ADDITIONAL SAFETY INSTRUCTIONS FOR COMBI DRILL.....	8
5.3	RESIDUAL RISK	9
5.4	SAFETY INSTRUCTIONS FOR MAINS POWERED CHARGERS & BATTERY PACKS	9-10
5.5	CONNECTION TO THE POWER SUPPLY (CHARGER)	10
6.	TECHNICAL DESCRIPTION	
6.1	IDENTIFICATION	11
7.	UNPACKING AND CHECKING	
7.1	PACKAGING	12
7.2	DRAPER 10.8V MULTI-TOOL INTERCHANGEABLE BATTERY SYSTEM	12
7.3	WHAT'S IN THE BOX.....	12
8.	PREPARING THE COMBI DRILL	
8.1	BATTERY CHARGING.....	13
9.	BASIC COMBI DRILL OPERATIONS	
9.1	DUST AND SWarf	14
9.2	INSTALLING AND REMOVING BITS.....	14
9.3	LED WORK LIGHT.....	14
9.4	FORWARD/REVERSE SELECTOR	14
9.5	TRIGGER.....	14
9.6	TORQUE SELECTION CONTROL	15
9.7	HOLDING THE DRILL.....	15
9.8	DRILLING WOOD AND PLASTIC.....	15
9.9	DRILLING METAL.....	15
9.10	DRILLING MASONRY.....	15
9.11	SCREWDRIVING	15
9.12	SCREWDRIVING	16
9.13	DRILLING WOOD AND PLASTIC.....	16
9.14	DRILLING METAL	16
9.15	DRILLING MASONRY.....	16
10.	OPTIONAL ACCESSORIES	
10.1	OPTIONAL ACCESSORIES.....	17
11.	MAINTENANCE & TROUBLESHOOTING	
11.1	MAINTENANCE	18
11.2	TROUBLESHOOTING GUIDE.....	18
12.	DISPOSAL	
12.1	DISPOSAL.....	19
12.2	BATTERY PACK DISPOSAL INFORMATION.....	19
13.	EXPLANATION OF SYMBOLS	
13.1	EXPLANATION OF SYMBOLS	20
DECLARATION OF CONFORMITY		ENCLOSED

3. WARRANTY

3.1 WARRANTY

Draper tools have been carefully tested and inspected before shipment and are guaranteed to be free from defective materials and workmanship.

Should the tool develop a fault, please return the complete tool to your nearest distributor or contact:

Draper Tools Limited, Chandler's Ford, Eastleigh, Hampshire, SO53 1YF. England.

Telephone Sales Desk: (023) 8049 4333 or:

Product Helpline (023) 8049 4344.

A proof of purchase must be provided.

If upon inspection it is found that the fault occurring is due to defective materials or workmanship, repairs will be carried out free of charge. This warranty period covering labour is 12 months from the date of purchase except where tools are hired out when the warranty period is 90 days from the date of purchase. The warranty is extended to 24 months for parts only. This warranty does not apply to any consumable parts, any type of battery or normal wear and tear, nor does it cover any damage caused by misuse, careless or unsafe handling, alterations, accidents, or repairs attempted or made by any personnel other than the authorised Draper warranty repair agent.

Note: If the tool is found not to be within the terms of warranty, repairs and carriage charges will be quoted and made accordingly.

This warranty applies in lieu of any other warranty expressed or implied and variations of its terms are not authorised.

Your Draper warranty is not effective unless you can produce upon request a dated receipt or invoice to verify your proof of purchase within the warranty period.

Please note that this warranty is an additional benefit and does not affect your statutory rights.

Draper Tools Limited.

4. INTRODUCTION

4.1 SCOPE

This cordless drill is designed for use with a variety of drill bits, intended for drilling holes in wood, plastic, metal, brick etc.

This product is intended for domestic and infrequent light trade use only. Any application other than that it was intended for, is considered misuse.

4.2 SPECIFICATION

Stock no.	16048
Part no.	CHD108SF
Drilling capacity:	
Wood	25mm
Mild steel	10mm
Masonry	10mm
Maximum torque.....	30Nm
Torque settings	20+1
Revolutions per minute (no load)	0-400/0-1300r/min
Impact rate	0-6000/0-19500bpm
Chuck type	Keyless
Sound pressure level (LpA):	83.14dB(A), K=3 db(A)
Sound power level (LWA):	94.14dB(A), K=3 db(A)
Uncertainty (K):	3dB(A)
Vibration level hammer drilling in metal†:.....	<2.70m/s ² , K=1.5m/s ²
Vibration level hammer drilling in concrete†:.....	5.98m/s ² , K=1.5m/s ²
Weight (machine only).....	1.11kg

†When sawing in wood.

Battery pack (16254):

Part No.	CB108LI
Type	Li-ion
Rated Voltage	10.8V
Rating	1.5Ah

Charger (16255):

Part No.	C108LI
Rated Voltage	230V~
Rated Frequency	50Hz
Rated D.C. output voltage	10.8V
Rated D.C. output current	2.0A
Protective device rated current	2A
Construction	Class II

4. INTRODUCTION

4.3 HANDLING & STORAGE

- Care must be taken when handling this product.
 - Dropping this power tool could have an effect on its accuracy and could also result in personal injury. This product is not a toy and must be respected.
- Environmental conditions can have a detrimental effect on this product if neglected.
 - Exposure to damp air can gradually corrode components.
 - If the product is unprotected from dust and debris, components will become clogged.
 - If not cleaned and maintained correctly or regularly, the machine will not perform at its best.

5. HEALTH AND SAFETY INFORMATION

5.1 GENERAL POWER TOOL SAFETY WARNINGS

WARNING Read all safety warnings, instructions, illustrations and specifications provided with this power tool. *Failure to follow all instructions listed below may result in electric shock, fire and/or serious injury.*

Save all warnings and instructions for future reference.

The term "power tool" in the warnings refers to your mains-operated (corded) power tool or battery-operated (cordless) power tool.

Work area safety

Keep work area clean and well lit. *Cluttered or dark areas invite accidents.*

Do not operate power tools in explosive atmospheres, such as in the presence of flammable liquids, gases or dust. *Power tools create sparks which may ignite the dust or fumes.*
Keep children and bystanders away while operating a power tool. *Distractions can cause you to lose control.*

Electrical safety

Power tool plugs must match the outlet. Never modify the plug in any way. Do not use any adapter plugs with earthed (grounded) power tools. *Unmodified plugs and matching outlets will reduce risk of electric shock.*

Avoid body contact with earthed or grounded surfaces, such as pipes, radiators, ranges and refrigerators. *There is an increased risk of electric shock if your body is earthed or grounded.*
Do not expose power tools to rain or wet conditions. *Water entering a power tool will increase the risk of electric shock.*

Do not abuse the cord. Never use the cord for carrying, pulling or unplugging the power tool. Keep cord away from heat, oil, sharp edges or moving parts. *Damaged or entangled cords increase the risk of electric shock.*

When operating a power tool outdoors, use an extension cord suitable for outdoor use. *Use of a cord suitable for outdoor use reduces the risk of electric shock.*

If operating a power tool in a damp location is unavoidable, use a residual current device (RCD) protected supply. *Use of an RCD reduces the risk of electric shock.*

Personal safety

Stay alert, watch what you are doing and use common sense when operating a power tool. Do not use a power tool while you are tired or under the influence of drugs, alcohol or medication. *A moment of inattention while operating power tools may result in serious personal injury.*

Use personal protective equipment. Always wear eye protection. *Protective equipment such as a dust mask, non-skid safety shoes, hard hat or hearing protection used for appropriate conditions will reduce personal injuries.*

Prevent unintentional starting. Ensure the switch is in the off-position before connecting to power source and/or battery pack, picking up or carrying the tool. *Carrying power tools with your finger on the switch or energising power tools that have the switch on invites accidents.*

Remove any adjusting key or wrench before turning the power tool on. *A wrench or a key left attached to a rotating part of the power tool may result in personal injury.*

Do not overreach. Keep proper footing and balance at all times. *This enables better control of the power tool in unexpected situations.*

Dress properly. Do not wear loose clothing or jewellery. Keep your hair and clothing away from moving parts. *Loose clothes, jewellery or long hair can be caught in moving parts.*

If devices are provided for the connection of dust extraction and collection facilities, ensure these are connected and properly used. *Use of dust collection can reduce dust-related hazards.*

Do not let familiarity gained from frequent use of tools allow you to become complacent and ignore tool safety principles. *A careless action can cause severe injury within a fraction of a second.*

5. HEALTH AND SAFETY INFORMATION

Power tool use and care

Do not force the power tool. Use the correct power tool for your application. *The correct power tool will do the job better and safer at the rate for which it was designed.*

Do not use the power tool if the switch does not turn it on and off. *Any power tool that cannot be controlled with the switch is dangerous and must be repaired.*

Disconnect the plug from the power source and/or remove the battery pack, if detachable, from the power tool before making any adjustments, changing accessories, or storing power tools. *Such preventive safety measures reduce the risk of starting the power tool accidentally.*

Store idle power tools out of the reach of children and do not allow persons unfamiliar with the power tool or these instructions to operate the power tool. *Power tools are dangerous in the hands of untrained users.*

Maintain power tools and accessories. Check for misalignment or binding of moving parts, breakage of parts and any other condition that may affect the power tool's operation. If damaged, have the power tool repaired before use. *Many accidents are caused by poorly maintained power tools.*

Keep cutting tools sharp and clean. *Properly maintained cutting tools with sharp cutting edges are less likely to bind and are easier to control.*

Use the power tool, accessories and tool bits etc. in accordance with these instructions, taking into account the working conditions and the work to be performed. *Use of the power tool for operations different from those intended could result in a hazardous situation.*

Keep handles and grasping surfaces dry, clean and free from oil and grease. *Slippery handles and grasping surfaces do not allow for safe handling and control of the tool in unexpected situations.*

Service

Have your power tool serviced by a qualified repair person using only identical replacement parts. *This will ensure that the safety of the power tool is maintained.*

5.2 ADDITIONAL SAFETY INSTRUCTIONS FOR COMBI DRILL

Warnings

1. Wear ear protectors. Exposure to noise can cause hearing loss.
2. Use auxiliary handle(s), if supplied with the tool. Loss of control can cause personal injury.
3. Hold power tool by insulated gripping surfaces, when performing an operation where the cutting accessory may contact hidden wiring or its own cord. Cutting accessory contacting a "live" wire may make exposed metal parts of the power tool "live" and could give the operator an electric shock.

5. HEALTH AND SAFETY INFORMATION

5.3 RESIDUAL RISK

Important note: Although the safety instructions and operating manuals for our tools contain extensive instructions for safe working with power tools, every power tool involves a certain residual risk which can not be completely excluded by safety mechanisms. Power tools must therefore always be operated with caution!

5.4 SAFETY INSTRUCTIONS FOR MAINS POWERED CHARGERS & BATTERY PACKS

Chargers

- The charger is for indoor use only.
- Prior to plugging the charger in to the supply, check that the plug and the cable are in good repair. If either are damaged, have the defective item replaced immediately by a suitably qualified person. If the casing of the battery charger is damaged, it is good policy to have the charger checked over by a suitably qualified person.
- Only use a correctly rated mains outlet to provide power, do not plug into site generators, attach to engine generators or D.C. sources. Do not use a mains socket outlet that is not switched.
- Use the correct Draper charger in conjunction with its corresponding battery pack (consult the Draper website for more information or to find your local stockist).
- Do not charge any other batteries with Draper chargers. Any other application is considered misuse.
- Do not attempt to charge battery packs that are too hot (over 30°C) or too cold (under 5°C), if these conditions apply set the battery pack aside to “normalise” before proceeding with the charging operation.
- Set up the charger and cable in a safe place where it won't be knocked, tripped over, stepped on, etc. and where it is well ventilated. Make sure the ventilation slots in the charger case are not obstructed, plug the charger into the socket outlet.
- Inspect the battery pack for damage, if it is undamaged, plug it into the charger, ensuring the correct orientation. (Most chargers and batteries have 'keys' etc, to make sure the battery pack is not inserted incorrectly, if you are having to 'force' the battery pack into the charger, the chances are you have it the wrong way round, check and try again.)
- Switch the charger on and check that the correct indicators illuminate, allow the battery pack to charge (see the specific instructions for your charger). Once charging is complete, switch the charger off, remove the battery pack and store, repeat the procedure if you have more than one battery pack to charge.

Caution: When the battery charger has been continuously used, the battery charger will be hot. Once the charging has been completed, give 15 minutes rest until the next charge.

- After charging is complete, unplug the charger from the socket outlet by pulling on the plug. Do not pull on the cable. Store the charger in a dry secure place.
- If, when the charger was switched on, the correct indications did not occur, leave for two or three minutes to allow the charger to stabilise, if the correct indications occur, allow the charging cycle to proceed as normal. If no indication appears at all, switch off, remove the battery pack, unplug the charger, check that the charger contacts and the battery contacts are clean and repeat the process. If there is still no indication, switch off, remove the battery pack, unplug the charger and check the fuse. If the fuse is blown, replace and repeat the process. If the fuse blows again, or if the fuse was intact, attempt no further action. Refer the charger to a suitably qualified person for repair.

5. HEALTH AND SAFETY INFORMATION

Battery packs

- Before charging, read the instructions.
- For indoor use. Do not expose to rain.
- Only use Draper battery packs with this product. Consult your Draper stockist for details.
- Do not charge any other manufacturer's battery packs using Draper chargers. Any other application is considered misuse.
- The battery must be removed from the appliance before it is recycled.
- The charger must be disconnected from the supply mains when removing the battery.
- The battery is to be disposed of in-line with local authority procedures.
- Do not use any other than the designated Draper batteries/chargers with this product.
- Do not crush, open or burn the battery. Exposure to potentially harmful materials may occur.
- In case of fire use CO₂ or dry chemical extinguisher.
- Do not expose to high temperatures >50°C. The battery may degrade at high temperatures.
- Charge battery in conditions between 5°C to 30°C with the specified charger designed for this battery.
- Do not use battery if it has been stored at 5°C or less. Allow it to “normalise” at room temperature before usage/charging.

Warning!

- Leaking battery packs
 - The electrolyte in battery packs is corrosive. Avoid contact with the skin.
 - If contact is made, flush the area with running water, pat dry and seek medical attention and advice at the earliest opportunity.
 - Inform medical personnel that the contaminant is a “high alkaline, corrosive liquid”.
 - If electrolyte comes into contact with the eyes, flush with copious amounts of water only. Seek medical attention immediately, relaying the information above.

5.5 CONNECTION TO THE POWER SUPPLY (CHARGER)

Caution: Risk of electric shock. Do not open.

This appliance is supplied with a moulded 3 pin mains plug for your safety. The value of the fuse fitted is marked on the pin face of the plug. Should the fuse need replacing, ensure the substitute is of the correct rating, approved to BS1362 and ASTA or BSI Kite marked.

ASTA 

BSI 

The fuse cover is removable with a small plain slot screwdriver. Ensure the fuse cover is replaced before attempting to connect the plug to an electrical outlet. If the cover is missing, a replacement must be obtained or the plug replaced with a suitable type.

If a replacement plug is to be fitted this must be carried out by a qualified electrician.

The damaged or incomplete plug, when cut from the cable should be disabled to prevent connection to a live electrical outlet.

This appliance is Class II[†] and is designed for connection to a power supply matching that detailed on the rating label and compatible with the plug fitted.

If an extension lead is required, use an approved and compatible lead rated for this appliance. Follow all the instructions supplied with the extension lead.

[†]*Double insulated* : This product requires no earth connection as supplementary insulation is applied to the basic insulation to protect against electric shock in the event of failure of the basic insulation.

IMPORTANT

If using an extension lead, follow the instructions that came with your lead regarding maximum load while cable is wound. If in doubt, ensure that the entire cable is unwound. Using a coiled extension lead will generate heat which could melt the lead and cause a fire.

6. TECHNICAL DESCRIPTION

6.1 IDENTIFICATION



① Variable speed trigger switch

② LED worklight

③ 10mm Keyless chuck

④ Torque collar

⑤ Hammer rotary selector

⑥ Two speed gearbox

⑦ belt clip

⑧ Battery charge indicator

⑨ Forward/Reverse selector

⑩ Soft grip

⑪ 10.8V 1.5Ah Li-ion battery pack

7. UNPACKING AND CHECKING

7.1 PACKAGING

Carefully remove the product from the packaging and examine it for any sign of damage that may have happened during shipping. Lay the contents out and check them against the parts shown below. If any part is damaged or missing, please contact the Draper Help Line (the telephone number appears on the Title page) and do not attempt to use the product.

The packaging material should be retained at least during the warranty period, in case the machine needs to be returned for repair.

Warning!

- Some of the packaging materials used may be harmful to children. Do not leave any of these materials in the reach of children.
- If any of the packaging is to be thrown away, make sure they are disposed of correctly, according to local regulations.

7.2 DRAPER 10.8V MULTI-TOOL INTERCHANGEABLE BATTERY SYSTEM

This tool is supplied without a battery, and without a charger. These optional accessories are available.

The Draper 10.8V multi-tool interchange range features an array of machines all running from the same battery. To find out the latest range of accessories including battery and charger please consult the Draper website for more information or to find your local Draper stockist.



7.3 WHAT'S IN THE BOX

As well as the combi drill, there are several parts not fitted or attached to it.

- (12) 1hr Charger
- (13) Spare 10.8V 1.5Ah Li-ion battery pack



8. PREPARING THE COMBI DRILL

8.1 BATTERY CHARGING - FIGS. 1 - 2

Check the mains voltage. Make sure the voltage of the power source is the same as the voltage specified on the rating plate of the charger unit.

Plug your mains plug into the power source. The green LED indicator (12.2) will blink indicating stand-by mode.

Insert battery pack into battery compartment of the charger. The red LED indicator (12.1) will light solid. This indicates that the battery pack is being fast charged automatically.

When the battery pack is fully charged, the red LED indicator will turn off and the green LED will illuminate solid.

Remove the battery pack from the charger and unplug.

IMPORTANT CHARGING NOTES:

Longest life and best performance can be obtained if the battery pack is charged when the surrounding air temperature is between 18°C (65°F) and 24°C (75°F). DO NOT charge battery pack in an air temperature below 4.5°C (40°F), or above 40.5°C (105°F). This is important and will prevent serious damage to the battery pack.

The charger is designed to fast charge the battery pack between 0°C (32°F) AND 45°C (113°F). If the battery pack, when inserted, is too cold or too hot, the charger will not charge. The green LED and the red LED will blink alternatively and continuously to indicate this situation. Once the air temperature is within tolerance, the fast charging will begin.



FIG.1

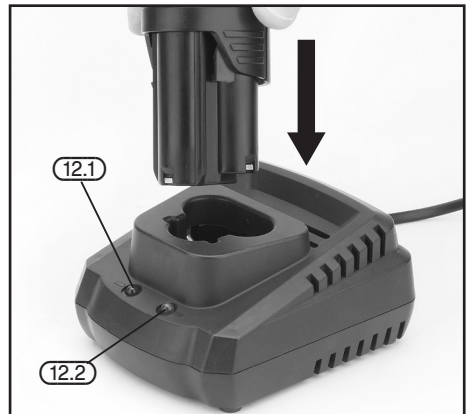

FIG.2

Charger Light Indicator

LED Indicator		Situation
Green	Red	
Blinking light	No Light	Stand by.
No Light	Solid light	Charging.
Solid Light	No light	Charging is complete.
Blinking Light	Blinking Light	Battery pack is too hot or cold (charging will begin automatically when battery reaches correct charging temperature).
No light	Blinking Light	Damaged or faulty battery pack.

9. BASIC COMBI DRILL OPERATIONS

9.1 DUST AND SWARF

A correctly fitted dust mask, suitable for the activity and in accordance to the relevant standard must be worn.

Swarf produced by metal drilling is extremely sharp. Take precautions when clearing swarf. The burr left on the hole is also sharp and should be removed with a suitable tool.

Always wear safety goggles.

Warning: Drill bit will be hot after use.

9.2 INSTALLING AND REMOVING BITS - Fig. 3

The drill is fitted with a keyless chuck, this means that a chuck key is not required to secure the drill or screwdriver bit.

- i. Place the drill bit shoulder into the chuck as far as it will go.
- ii. Tighten the chuck firmly.

Note: Short screwdriver bits need only be inserted to the depth of the hexagon shank before tightening chuck by hand.

9.3 LED WORK LIGHT - Fig. 4

To aid drilling a screwdriving in confined, inadequately lit spaces, the LED work light (2) automatically illuminates when the trigger is activated.

9.4 FORWARD/REVERSE SELECTOR - Fig. 5

The forward/reverse selector switch determines the direction of rotation of the chuck, i.e. clockwise or anticlockwise.

- i. Stop the drill and push switch (9) to the left or right.

Note: When the direction switch is pushed to the left, the chuck will rotate clockwise.

Before operation, check that the switch is set in the required position. Do not change the direction of rotation until the chuck comes to a complete stop.

- ii. When the drill is not in use move the forward/reverse selector switch to the neutral position (the middle setting) to lock the trigger out.

9.5 TRIGGER - FIG.5

When the trigger (1) is depressed, the chuck will rotate (provided the forward/reverse selector switch is set in the forward or reverse position). This trigger switch is electronic which enables the user to vary the speed continuously. The speed varies according to how far the trigger is depressed. The further it is depressed, the faster the chuck will rotate. The lighter it is depressed, the slower it will rotate.

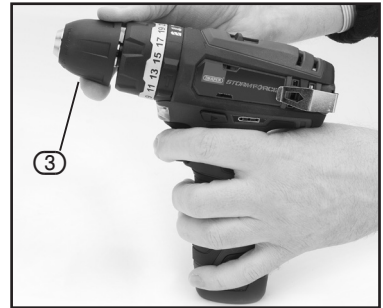

FIG.3



FIG.4

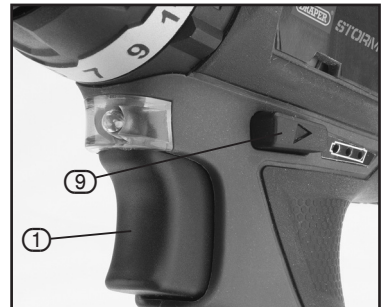

FIG.5



9. BASIC COMBI DRILL OPERATIONS

9.6 TORQUE SELECTION CONTROL - Fig. 6

By turning the collar (4) it is possible to adjust the amount of torque.

Settings 1-21 provide a facility for setting the torque to the required level. For example, this means that repetitive driving of screws of the same size will be driven into the material to the same torque, thus giving the same fixing strength, or in the case of countersunk screws, these will all be driven to the same depth in the material.

The torque control prevents the heads of small diameter screws being twisted off when correctly set.

By turning the collar (5) it is possible to switch between rotary drilling, percussion drilling and screwdriving functions. Set the "twist drill" setting , for rotary drilling/screwdriving, in the "hammer drill" setting , the percussion feature will come into action. This is intended for drilling into masonry, etc. Turn the collar to the  setting to use the drill for screwdriving.

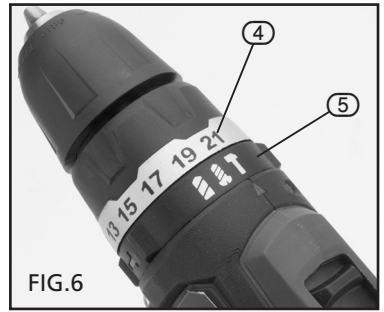

9.7 HOLDING THE DRILL - Figs. 7 - 8

The drill casing is designed to be held comfortably in two ways,

1. By the handle.
2. Or by the in-line support grip.

9.8 DRILLING WOOD AND PLASTIC

To prevent splitting around the drill holes on the reverse side, place a piece of scrap timber under the material to be drilled.

9.9 DRILLING METAL

Metals such as sheet steel, aluminium and brass may be drilled. Mark the point to be drilled with a centre punch to help the drill bit tip to locate. A drop of oil on the area will aid cutting and help prolong the life of the bit.

9.10 DRILLING MASONRY

Start drilling at a low speed to prevent the drill bit from wandering. Once penetration is achieved, fully depress the trigger to achieve maximum speed and hammer power.

9.11 SCREWDRIVING

To prevent slip or damage to the screw head, match the screwdriver bit to the screw head size. To remove screws, move the direction switch to the reversing position and apply pressure to the screw head and depress the trigger slowly).

Screwdriver bits are consumable items.

Before drilling check that there are no hidden hazards such as electrical cables, water or gas pipes running below the surface use a metal/voltage detector.

Do not expose either the drill or charger to rain or water.

Do not overcharge the battery (more than six hours) as this could damage the battery cells.



9. BASIC COMBI DRILL OPERATIONS

9.12 SCREWDRIVING

To prevent slip or damage to the screw head, match the screwdriver bit to the screw head size.

To remove screws:

- Move the direction switch to the reversing position and apply pressure to the screw head and depress the trigger slowly).

Screwdriver bits are consumable items.

9.13 DRILLING WOOD AND PLASTIC – FIG. 9

To prevent splitting around the drill holes on the reverse side, clamp a piece of scrap timber **A** under the material to be drilled.

9.14 DRILLING METAL – FIG.10

Metals such as mild steel, aluminium and brass may be drilled.

- Mark the point to be drilled with a centre punch **B** to help the drill bit tip to locate.
- A drop of oil **C** on the drilled area will aid cutting and help prolong the life of the bit.

Note: Although metal drilling is technically within the capabilities of this drill, its rotational speed is not always fast enough to achieve perfect results every time. For this reason, extra caution should always be taken when drilling metal, as snagging of the drill may occur.

9.15 DRILLING MASONRY

Start drilling at a low speed to prevent the drill bit from wandering. Once penetration is achieved, fully depress the trigger to achieve maximum speed and hammer power.

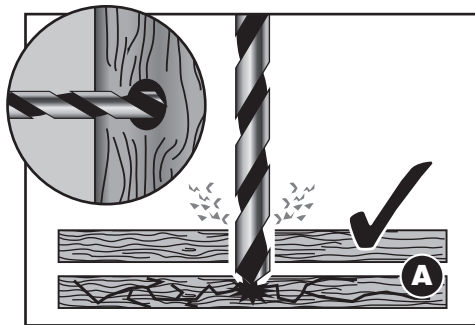

FIG.9

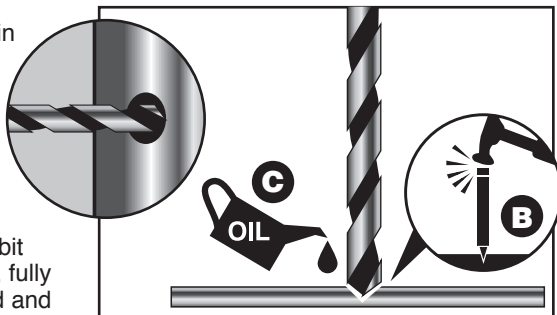

FIG.10

10. OPTIONAL ACCESSORIES

10.1 OPTIONAL ACCESSORIES

A full range of accessories are available from Draper Tools.

Please visit our website for details: www.drapertools.com

11. MAINTENANCE & TROUBLESHOOTING

11.1 MAINTENANCE

Regular inspection and cleaning reduces the necessity for maintenance operations and will keep your tool in good working condition.

The motor must be correctly ventilated during tool operation. Avoid blocking the air inlets and vacuum the ventilation slots regularly.

11.2 TROUBLESHOOTING GUIDE

Note: Remove the battery pack before carrying out adjustment, servicing or maintenance.

Problems	Possible cause	Required action
Drill does not operate.	<ul style="list-style-type: none">– Battery pack no charge.– Forward/reverse not selected.– battery pack faulty or damaged.	<ul style="list-style-type: none">– Re-charge battery pack.– Select forward/reverse.– Replace battery pack.
Motor runs, but slowly/ losing power.	<ul style="list-style-type: none">– Battery pack no charge.– Battery pack faulty or damaged.	<ul style="list-style-type: none">– Re-charge battery pack.– Replace battery pack.
Chuck does not close or grip	<ul style="list-style-type: none">– Swarf in chuck.	<ul style="list-style-type: none">– Clean inside of chuck with cleaning fluid.
Battery pack doesn't charge / non-illumination / non illumination of charger.	<ul style="list-style-type: none">– Fuse blown in charger plug.– Charger faulty.	<ul style="list-style-type: none">– Replace fuse.– Replace charger.

12. DISPOSAL

12.1 DISPOSAL

- At the end of the machine's working life, or when it can no longer be repaired, ensure that it is disposed of according to national regulations.
- Contact your local authority for details of collection schemes in your area.

In all circumstances:

- Do not dispose of power tools with domestic waste.
- Do not incinerate.
- Do not dispose of WEEE* as unsorted municipal waste.



Li-ion

* Waste Electrical & Electronic Equipment.

12.2 BATTERY PACK DISPOSAL INFORMATION

Warning!

- Do not put battery pack in fire or mutilate – cells may burst or release toxic materials.
- Do not short circuit cells, may cause burns.
- The battery pack must be removed from the appliance before it is scrapped.
- The battery pack is to be disposed of safely.
- Do not mutilate batteries, corrosive electrolyte will be released.
- Do not dispose of batteries or cells in a charged condition.

Expired batteries must be recycled/disposed of in accordance with the appropriate regulation or legislation. They should be returned to your local warranty agent/stockist.

13. EXPLANATION OF SYMBOLS

13.1 EXPLANATION OF SYMBOLS



Read the instruction manual.



Wear safety glasses.



Wear ear defenders.



Wear protective gloves.



Long and loose hair must be contained or securely tied back.



Do not abandon into the environment.



Keep out of the reach of children.



Warning!



Warning! Risk of crushing.



Direction of rotation.



Single value noise marking.
(Maximum declared A-Weighted sound power level in decibels).



Class II construction
(Double insulated).



WEEE –

Waste Electrical & Electronic Equipment.

Do not dispose of Waste Electrical & Electronic Equipment in with domestic rubbish.



Lithium-ion product.

Li-ion



Do not incinerate or throw onto fire.



For indoor use only.
Do not expose to rain.



Fuse.



Polarity indication.



Rated voltage.

CONTACTS

Draper Tools Limited, Hursley Road,
Chandler's Ford, Eastleigh, Hampshire. SO53 1YF. U.K.

Helpline: (023) 8049 4344

Sales Desk: (023) 8049 4333

Internet: drapertools.com

E-mail: sales@drapertools.com

General Enquiries: (023) 8026 6355

Service/Warranty Repair Agent:

For aftersales servicing or warranty repairs, please contact the Draper Tools Helpline for details of an agent in your local area.

YOUR DRAPER STOCKIST

TASW1019

©Published by Draper Tools Limited.

No part of this publication may be reproduced, stored in a retrieval system or transmitted in any form or by any means, electronic, mechanical photocopying, recording or otherwise without prior permission in writing from Draper Tools Ltd.