

Operating instructions Washer-dryer





To avoid the risk of accidents or damage to the machine, it is **essential** to read these instructions before it is installed and used for the first time.



Contents

Caring for the environment	6
Warning and Safety instructions	7
Operating the washer-dryer	16
Control panel.....	16
Touch display and sensor controls.....	16
Main menu.....	17
Examples of how to operate the appliance.....	18
Applications.....	20
Before using for the first time	21
Miele@home	22
1. Setting the display language	23
2. Setting up Miele@home	23
3. Setting the clock format	24
4. Removing the transit bars	24
5. Setting up TwinDos	25
6. Starting the calibration programme.....	28
Environmentally friendly washing and drying	29
WASHING	30
1. Prepare the laundry	30
General tips	30
2. Select a programme	31
3. Selecting programme settings	32
4. Loading the washer-dryer	34
5. Add detergent.....	35
Replacing detergent cartridges	35
6. Starting the programme	41
7. End of the programme/unloading laundry.....	42
Spin speeds.....	42
Programme chart.....	44
Programme sequence	49
Extras	52
Detergent.....	54
Water softeners	54
Fabric conditioners, liquid starch, starch	54
DRYING	58
1. Prepare the laundry	58
2. Select a programme	59
3. Selecting programme settings	60

4. Loading the washer-dryer	61
5. Starting the programme	61
6. End of the programme/unloading laundry.....	62
Programme chart.....	63
Timed drying	68
Thermospin	69
Extras	69
WASHING AND DRYING	70
1. Prepare the laundry	70
2. Selecting a programme	70
3. Load the drum	70
4. Selecting programme settings	71
5. Adding detergent.....	71
6. Starting/ending the programme	71
After each washing or drying programme	72
Changing the programme sequence	73
Changing a programme (safety lock)	73
Cancelling a programme	73
Interrupting a programme.....	73
Favourite programmes.....	74
Creating favourites	74
Washing/drying assistant	75
Timer/SmartStart.....	76
Cleaning and care	78
Starting maintenance programmes	78
Clean "TwinDos"	78
Clean machine.....	79
Rinse out fluff	79
Cleaning the casing and control panel.....	80
Cleaning the detergent dispenser drawer	80
Cleaning the water intake filter	82
Problem solving guide	83
A programme does not start	83
Fault message after a programme has been interrupted.	84
Fault message at the end of a programme	85
Problems with TwinDos	87
Problems with TwinDos	88

Contents

General problems with the washer-dryer	89
An unsatisfactory wash result	92
Unsatisfactory drying results.....	93
The door will not open.....	94
Opening the door in the event of a blocked drain outlet and/or power cut	95
Service	97
Contact in the event of a fault	97
Warranty	97
Optional accessories.....	97
EPREL database	97
Installation	98
Front view	98
Rear view.....	99
Installation surface	100
Carrying the washer-dryer to its installation site	100
Removing the transit bars	100
Refitting the transit bars	102
Installing under a worktop	102
Aligning the washer-dryer	103
The water protection system	104
Water intake	105
Water drainage	106
Electrical connection	107
Garment care label symbols	108
Technical data	109
EU Conformity declaration	110
UK Conformity declaration	110
Consumption data	111
Settings	112
Controls / Display 	113
Language 	113
Code.....	113
Memory	113
Clock display.....	113
Volume.....	113
Display brightness.....	114
Temperature unit.....	114

Programme sequence	114
TwinDos	114
Soiling.....	115
Water plus level	115
Maximum rinse level.....	115
Soak duration	115
Longer Pre-wash Cottons	116
Gentle action	116
Comp laundry protection	116
Drying levels	116
Extended cool down	117
Network.....	117
Miele@home	117
Remote control.....	118
SmartGrid.....	118
Remote Update	119
Appliance parameters	120
Copyrights and licences for operator and control software.....	120
Copyrights and licences for the communication module.....	120
Installation requirements	121
Low water pressure	121
Suds cooling.....	121
Temperature reduction	121
Detergents and care products	122
Detergent.....	122
Specialist detergents 	123
Fabric care 	124
Additives 	124
Machine care.....	124

Caring for the environment

Disposal of the packing material

The packaging is designed to protect the appliance from damage during transportation. The packaging materials used are selected from materials which are environmentally friendly for disposal and should be recycled.

Recycling the packaging reduces the use of raw materials in the manufacturing process and also reduces the amount of waste in landfill sites.

Disposing of your old appliance

Electrical and electronic appliances often contain valuable materials. They also contain specific materials, compounds and components, which were essential for their correct function and safety. These could be hazardous to human health and to the environment if disposed of with your domestic waste or if handled incorrectly. Please do not, therefore, dispose of your old appliance with your household waste.



Please dispose of it at your local community waste collection / recycling centre for electrical and electronic appliances, or contact your dealer or Miele for advice. You are also responsible for deleting any personal data that may be stored on the appliance being disposed of. Please ensure that your old appliance poses no risk to children while being stored prior to disposal.

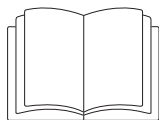

- ▶ It is **essential** to read these instructions.

This washer-dryer complies with all current local and national safety requirements. However, inappropriate use can lead to personal injury and damage to property.

Read the operating instructions carefully before using the washer-dryer. They contain important information on safety, installation, use and maintenance. This prevents both personal injury and damage to the washer-dryer.

In accordance with standard IEC 60335-1, Miele expressly and strongly advises that you read and follow the instructions in the chapter on installing the washer-dryer as well as the safety instructions and warnings.

Miele cannot be held liable for damage caused by non-compliance with these instructions.

Keep these operating instructions in a safe place and pass them on to any future owner.

Correct application

- ▶ This washer-dryer is intended for use in domestic households and similar working and residential environments.
- ▶ This washer-dryer is intended for use in domestic households for the following applications only:
 - washing textiles which have a care label stating that they are washable.
 - drying textiles which have been washed in water and have a care label stating that they are suitable for tumble drying.

Warning and Safety instructions

Any other usage is not permitted. Miele cannot be held liable for damage resulting from improper use or incorrect operation of the machine.

- ▶ This washer-dryer is not intended for outdoor use.
- ▶ This washer-dryer can only be used by people with reduced physical, sensory or mental capabilities, or lack of experience or knowledge, if they are supervised whilst using it or have been shown how to use it in a safe way and understand and recognise the consequences of incorrect operation.

Safety with children

- ▶ Children under eight years of age must be kept away from the washer-dryer unless they are constantly supervised.
- ▶ Children eight years and older may only use the washer-dryer unsupervised if they have been shown how to use it safely and recognise and understand the consequences of incorrect operation.
- ▶ Children must not be allowed to clean or maintain the washer-dryer unsupervised.
- ▶ Please supervise children in the vicinity of the washer-dryer and do not let them play with it.

Technical safety

▶ Before setting up the washing-dryer, check it for any externally visible damage.

Do not install or use a damaged washer-dryer.

▶ Before connecting the washer-dryer, ensure that the connection data on the data plate (fuse rating, voltage and frequency) match the mains electricity supply. If in any doubt, consult a qualified electrician.

▶ The electrical safety of this washer-dryer can only be guaranteed when correctly earthed.

It is essential that this standard safety requirement is met. If in any doubt, please have the household wiring system tested by a qualified electrician.

Miele cannot be held liable for the consequences of an inadequate earthing system (e.g. electric shock).

▶ Do not connect the machine to the mains electricity supply by an extension lead, multi-socket adapter or similar. These can overheat and are a fire hazard.

▶ Unauthorised repairs could result in unforeseen dangers for the user, for which the manufacturer cannot accept liability. Repairs should only be undertaken by a Miele authorised service technician, otherwise any subsequent damage will not be covered by the guarantee.

▶ Please observe the instructions in “Installation” and the “Technical data”.

Warning and Safety instructions

▶ This washer-dryer is supplied with a special lamp to cope with particular conditions (e.g. temperature, moisture, chemical resistance, abrasion resistance and vibration). This lamp must only be used for the purpose for which it is intended. The lamp is not suitable for room lighting. Replacement lamps may only be fitted by a Miele authorised technician or by the Miele Customer Service Department.

The washer-dryer contains 1 light source corresponding to energy efficiency class G.

▶ The electrical socket must be easily accessible after installation so that the washer-dryer can be disconnected from the electricity supply if necessary.

▶ The washer-dryer must be isolated from the electricity supply when cleaning and maintaining the machine and in the event of a fault.

▶ The Miele “Water protection system” protects from water damage provided the following conditions are met:

- The machine is correctly plumbed in and connected to the electricity supply.
- If a fault or damage has been identified, the washer-dryer must be examined by a competent person before further use, and repaired if necessary.

▶ The water inlet pressure must be at least 100 kPa and must not exceed 1000 kPa.

▶ Faulty components must only be replaced by genuine Miele original spare parts. Only when these parts are fitted can Miele guarantee the safety standards of the machine.

▶ If the electrical connection cable is faulty it must only be replaced by a Miele authorised service technician to protect the user from danger.

- ▶ This washer-dryer must not be used in a non-stationary location (e.g. on a ship).
- ▶ Do not make any alterations to the washer-dryer, unless authorised to do so by Miele.
- ▶ Temporary or permanent operation on an autonomous power supply system or a power supply system that is not synchronised with the mains power supply (e.g. island networks, back-up systems) is possible. A prerequisite for operation is that the power supply system complies with the specifications of EN 50160 or an equivalent standard.

The function and operation of the protective measures provided in the domestic electrical installation and in this Miele product must also be maintained in isolated operation or in operation that is not synchronised with the mains power supply, or these measures must be replaced by equivalent measures in the installation. As described, for example, in the current version of BS OHSAS 18001–2 ISO 45001.

- ▶ The manufacturer's warranty will be invalidated if the washer-dryer is not repaired by a service technician authorised by Miele.

Correct use

- ▶ Do not install the washer-dryer in a room where there is a risk of frost. Frozen hoses may burst or split. The reliability of the electronic control unit may be impaired at temperatures below freezing point.
- ▶ Before using the machine for the first time, check that the transit bars at the rear of the washer-dryer have been removed (see "Installation - Removing the transit bars"). During spinning, a transit bar which is still in place may result in damage to both the washer-dryer and adjacent furniture or appliances.
- ▶ Turn off the stopcock if the washer-dryer is to be left for any length of time (e.g. holiday), especially if there is no floor drain (gully) in the immediate vicinity.

Warning and Safety instructions

- ▶ Flooding danger. If hooking the drain hose into a wash basin, check that the water can drain off quickly enough to prevent the sink from overflowing. Make sure the drain hose is secure, so that the force of the water flowing out of the hose does not dislodge it.
- ▶ Take care to ensure that foreign objects (e.g. nails, pins, coins, paper clips) do not find their way into the machine with the laundry. These may damage components of the machine (e.g. suds container, drum), which in turn can result in damage to the laundry.
- ▶ Do not leave any detergent dispensing aids, e.g. plastic dispenser balls, in the laundry when tumble drying. These dispensers can melt during the drying programme and cause damage to the washer-dryer and the laundry.
- ▶ Risk of burning or scalding due to hot temperatures. The metal cap located on the inside of the door glass will be hot after drying. Open the door wide after drying. Do not touch the metal cap.
- ▶ If the correct amount of detergent is dispensed, the washer-dryer should not need to be descaled. If, however, there is large build-up of limescale and you need to descale it, you must use a special non-corrosive descaling agent. A suitable descaling agent is available to order from Miele (see “Optional accessories”). Instructions on the packaging must be strictly observed.
- ▶ Take care when opening the drum door after using the steam function. Danger of burning due to escaping steam and the high temperature of the surface of the drum as well as the porthole glass. Stand back away from the machine and wait until the steam has dissipated.

Warning and Safety instructions

- To prevent the risk of fire, the following textiles **must not** be dried:
- Items which have not been washed.
 - Items, such as workwear, which have not been thoroughly washed and which are still soiled with grease, oil or other deposits (such as cooking oil, cosmetics, lotions etc). If items have not been thoroughly washed there is a danger that these might ignite when heated, even after they have been removed from the washer-dryer at the end of the programme.
 - Items (e.g. mops and floor cloths) which have been treated with inflammable cleaning agents or which contain residues of acetone, alcohol, benzene, petrol, stain remover, turpentine, wax and wax remover or other chemicals.
 - Items which have been splashed with hair lacquer, hair spray, nail varnish remover or similar substances.

When washing heavily soiled items ensure that you use sufficient detergent and select a high temperature. If in doubt, wash the items several times.

- To prevent the risk of fire, the following textiles must not be tumble dried:
- Items which have been cleaned using chemicals (e.g. professional dry-cleaning agents).
 - Items which contain a large proportion of rubber, foam rubber or rubber-like materials. For example, products made from latex foam rubber, shower caps, waterproof textiles, rubberised articles and items of clothing and pillows with foam rubber filling.
 - Damaged items which contain padding or fillings (e.g. pillows, jackets). When damaged, the filling can get out with the risk of it igniting.

Warning and Safety instructions

- ▶ Fabric conditioner and similar products must be used according to the instructions on the manufacturer's packaging.
- ▶ Only use dyes specified by the manufacturer as being suitable for use in a domestic washing machine. These must only be used in domestic quantities. Always observe the manufacturer's instructions carefully.
- ▶ Colour run and dye removers contain sulphur compounds which can cause corrosion. Do not use these products in this washer-dryer.
- ▶ In many programmes, the heating phase is followed by a cooling down phase to ensure that the items are not too hot to handle when you remove them (this also avoids the danger of the laundry self-igniting). The programme is not finished until the cooling down phase has been completed. As soon as the programme has finished, remove all laundry from the drum.
- ▶ Warning: do not switch the washer-dryer off before the drying programme has finished. If this is done, the laundry must be removed immediately and hung up or spread out to cool it down.
- ▶ This washer-dryer must not be connected to a controllable socket, e.g. a timer or electrical device with peak-load negotiation. There is a risk of the laundry igniting itself if a drying programme is cancelled before the cooling phase has finished.
- ▶ Textiles which have been pre-treated in solvent based cleaning agents must be thoroughly rinsed in clean water before being washed in the machine.
- ▶ Do not use solvent based cleaning agents, e.g. those containing benzene, in this washer-dryer, as this may result in damage to component parts and create toxic fumes. Such agents also pose a fire and explosion hazard.

Warning and Safety instructions

- ▶ If detergent comes into contact with the eyes, rinse them thoroughly with lukewarm water immediately. If swallowed, seek medical assistance immediately and retain the packaging or label for reference. Those with skin problems or sensitive skin should avoid their skin coming into contact with detergent.
- ▶ The maximum load for this washer-dryer is 8.0 kg (dry weight) for washing and 5.0 kg (dry weight) for tumble drying. See the “Programme chart” for the maximum recommended loads for individual programmes.

Accessories

- ▶ Only use original Miele accessories. If other parts are used, warranty, performance and product liability claims will be invalidated.
- ▶ If you order a plinth for this washer-dryer (available from Miele as an optional accessory), make sure it is the correct one.
- ▶ Miele will guarantee to supply functional spare parts for a minimum of 10 years and up to 15 years following the discontinuation of your washer-dryer.

Miele cannot be held liable for damage caused by non-compliance with these Warning and Safety instructions.

Operating the washer-dryer

Control panel

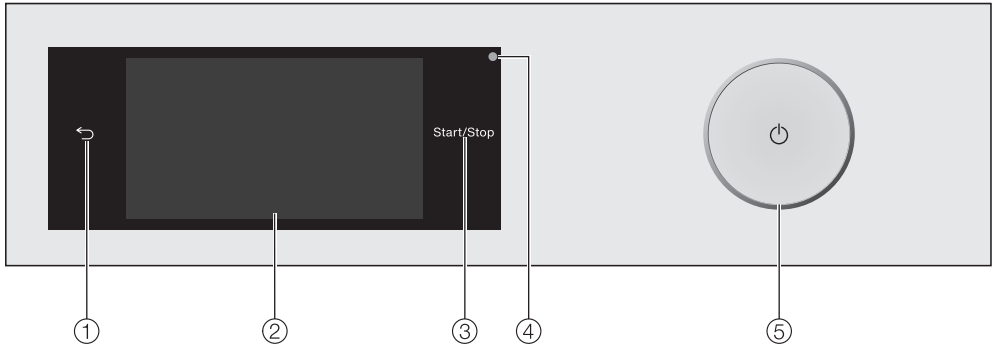

- ① **Sensor control** ↩
Takes you back one level in the menu.
- ② **Touch display**
- ③ **Start/Stop** sensor control
Touching the *Start/Stop* sensor control starts the selected programme or cancels a programme that has already been started. The programme can be started as soon as the sensor control is flashing on and off. The sensor control lights up constantly once the programme has started.
- ④ **Optical interface**
This is used by the Customer Service Department as a transmission point.
- ⑤ **Button** ⏻
For switching the washer-dryer on and off. The washer-dryer switches off automatically to save energy. It is switched off 15 minutes after the end of the programme/Anti-crease phase, or after being switched on if no further selection is made.

Touch display and sensor controls

The ↩ and *Start/Stop* sensors and the sensors in the display react to finger tip contact.

The touch display can be scratched by pointed or sharp objects, e.g. pens. Only touch the display with your fingers.

Operating the washer-dryer

Main menu

After switching on the washer-dryer, the main menu will appear in the display.

You can access all the important sub-menus from the main menu.

Touch the  sensor control at any time to return to the main menu. Values set previously are not saved.

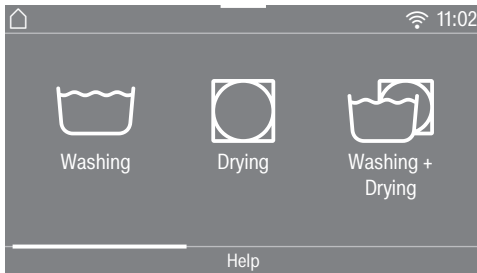

You can scroll to the next page of the main menu by swiping your finger across the display.

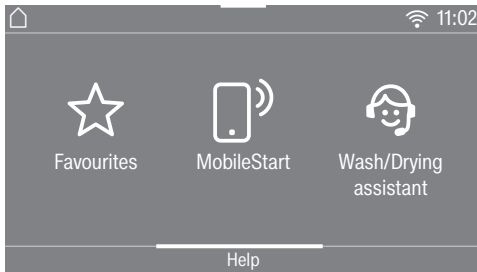

or

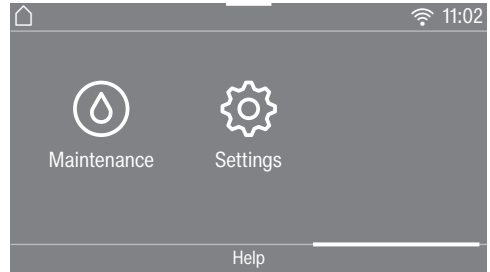

Washing

You can select the various wash programmes.

Drying

You can select the various drying programmes.

Washing + Drying

You can select programmes which include thorough washing and drying.

Favourites

You can save up to 12 of your own customised wash programmes (see “Favourites”).

MobileStart

You can operate your washer-dryer remotely with MobileStart using the Miele app.

The Remote control setting must be switched on.

Touch the MobileStart sensor control and follow the instructions in the display.

Operating the washer-dryer

Wash/Drying assistant

The *washing and drying assistant* guides you step by step so that you can select the optimum wash programme and drying programme for your laundry (see “Washing and Drying assistant”).

Maintenance

Maintenance options for the TwinDos system and the Rinse out fluff and Clean machine programmes are located in the Maintenance menu (see “Cleaning and care”).

Settings

You can alter the washer-dryer’s electronics to suit different requirements in the Settings menu (see “Settings”).

Examples of how to operate the appliance

Selection lists

Washing menu (single selection)

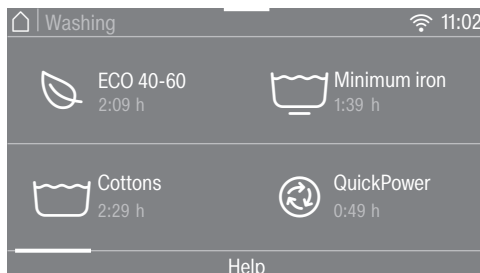

You can scroll right or left by swiping your finger across the screen. Place your finger on the touch display and swipe it in the direction you want.

The orange scroll bar under the pictures shows that there are further options to choose from.

To select a wash programme, touch a programme name.

The display will change to the standard menu for that programme.

Extras menu (multiple selection)

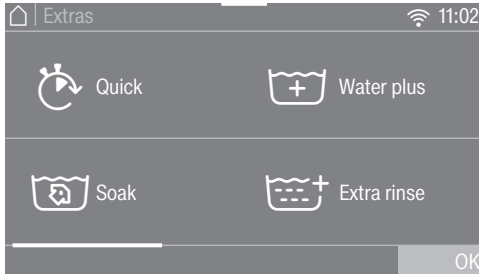

You can scroll right or left by swiping your finger across the screen. Place your finger on the touch display and swipe it in the direction you want.

The orange scroll bar under the pictures shows that there are further options to choose from.

To select *Extras*, touch one or more sensor controls with *Extras*.

Currently selected *Extras* are marked orange.

To deselect an *Extra*, simply touch the *Extra* sensor control again.

Use the *OK* sensor control to activate all selected *Extras*.

Setting numerical values

You can set numerical values in some menus.

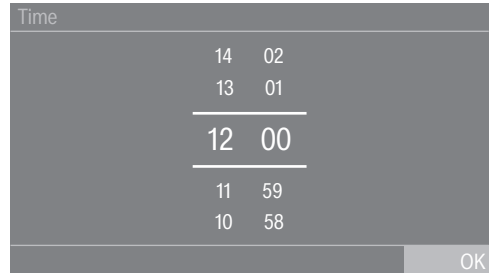

Enter the numbers by swiping up or down. Place your finger on the number that you want to change and move your finger in the direction you want. Use the *OK* sensor control to accept the set numerical value.

Tip: Briefly touching the numbers will bring up the numerical keypad. Once a valid number has been entered, the *OK* sensor control will be highlighted green.

Operating the washer-dryer

Pull-down menu

The pull-down menu can be used to display information, e.g. about a wash programme.

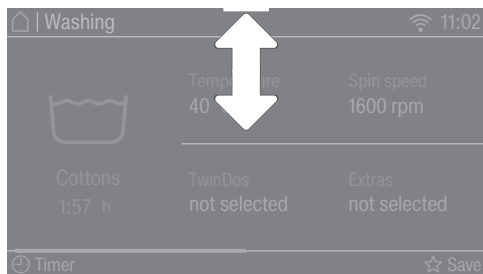

Touch the top edge of the screen in the middle and drag down with your finger.

Help display

Help appears along the bottom line of the display in the main menu and the programme selection menus.

- Touch the **Help** sensor control to display the text.
- Touch the **Close** sensor control to return to the previous screen.

Exiting a menu level

- Touch the **↶** sensor control to return to the previous screen.

Entries made before this which have not been confirmed with **OK** will not be saved.

Applications

You can use this washer-dryer to:

- **Wash separately**
Maximum load (depending on programme) 8.0 kg
 - **Dry separately**
Maximum load (depending on programme) 5.0 kg
- or
- **Wash and dry in a continuous sequence**
Maximum load (depending on programme) 5.0 kg

Before using for the first time

 Damage resulting from incorrect installation and connection.

Installing and connecting the washer-dryer incorrectly will cause serious property damage.

Please observe the instructions in "Installation".

This washer-dryer has undergone a complete functional test at the factory and there will be some residual water in the drum from this process.

Removing the protective foil and stickers

■ Remove:

- Any protective film from the door
- Any stickers from the front and the lid

Please do not remove any labels (e.g. the data plate) which are visible when you open the door.

Remove the detergent cartridges and the drain hose elbow from the drum

Two detergent cartridges for automatic detergent dispensing and an elbow piece for the drain hose are stored in the drum.

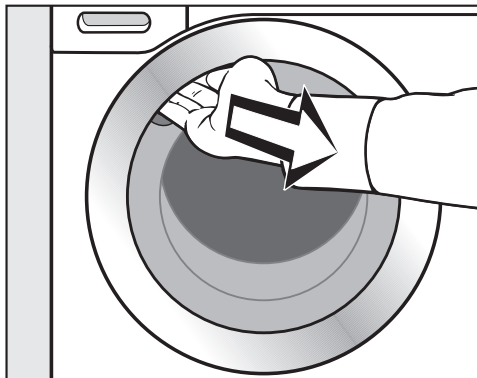

- Reach under the door grip and pull the door open.
- Take the two cartridges and the elbow piece out of the drum.

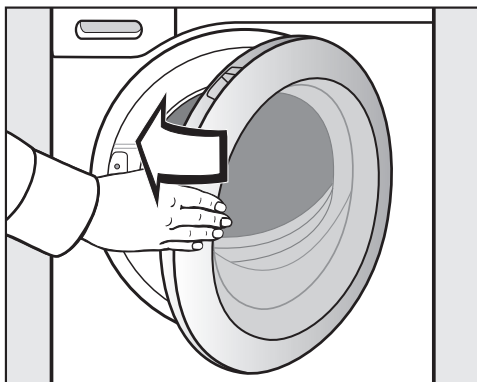

- Shut the door with a gentle swing.

Before using for the first time

Miele@home

Your washer-dryer is equipped with an integrated WiFi module.

To use this feature, you will need:

- A WiFi network
- The Miele app
- A Miele user account. The user account can be created via the Miele app

The Miele app will guide you as you connect your washer-dryer to your home WiFi network.

Once your washer-dryer is connected to your WiFi network, you can use the app to carry out the following activities, for example:

- Controlling your washer-dryer remotely
- Calling up information on the operating status of your washer-dryer
- Calling up information on the programme sequence of your washer-dryer

Connecting your washer-dryer to your WiFi network will increase energy consumption, even when the washer-dryer is switched off.

Make sure there is sufficient signal strength for your WiFi network at the washer-dryer installation site.

Availability of the WiFi connection

The WiFi connection shares a frequency range with other appliances (including microwave ovens and remote control toys). This can give rise to sporadic or even complete connection failures. Therefore, the availability of featured functions cannot be guaranteed.

Miele@home availability

The ability to use the Miele app depends on the availability of the Miele@home service in your country.

The Miele@home service is not available in every country.

For information about availability, please visit www.miele.com.

Miele App

The Miele App is available to download free of charge from the Apple App Store[®] or from the Google Play Store[™].



Switching the washer-dryer on

- Press the  button.

The welcome screen will light up.

The display will guide you through the **6 steps** of the initial commissioning process.

1. Setting the display language

You will be asked to select the display language. It is possible to change the language at any time via the *Settings menu*.

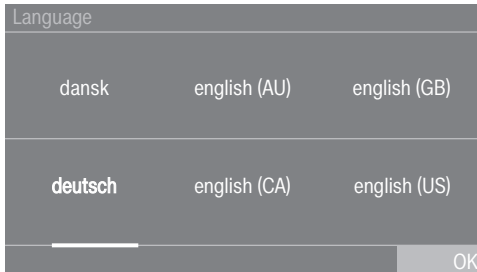

- Scroll to the left or the right until the language you want appears.
- Touch the sensor control for the language you want.

The selected language will be highlighted in *orange* and the display will change to the next setting.

2. Setting up Miele@home



- To set up Miele@home now: touch the *Continue* sensor control.

Tip: To postpone setup until later: touch the *Skip* sensor control. The following message will then appear in the display: **i** It is possible to set up later in "Settings" / "Miele@home".. Confirm with the *OK* sensor control.

Selecting a connection method

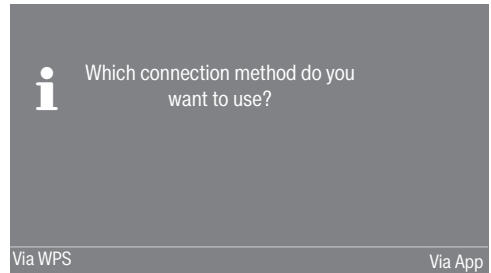

- Select the connection method you wish to use.

You will then be guided by the display and the Miele app.

Before using for the first time

3. Setting the clock format

The time of day can be displayed in 12-hour or 24-hour clock format.

- Select the clock format you want and confirm this with the *OK* sensor control.

The display will then bring up the screen for setting the time of day.

Setting the time of day

This message only appears if the washer-dryer has not yet been connected to a WiFi network. The time of day is set automatically when a connection is established with a WiFi network.

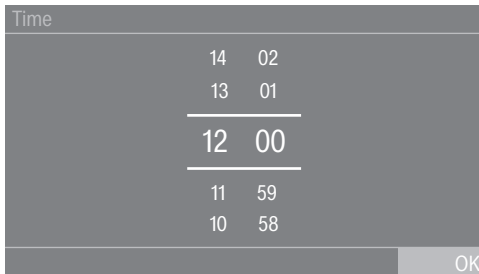

- Place your finger on the number that you want to change and move your finger in the direction you want.
- Confirm with the *OK* sensor control.

4. Removing the transit bars

 Damage resulting from failure to remove the transit bars.

Failure to remove the transit bars can result in damage to the washer-dryer and to adjacent cabinetry or appliances.

Remove the transit bars as described in "Installation".

The following message will then appear in the display:

 Remove transit bars and observe "Warning and Safety instructions" and "Before using for the first time" in the operating instructions

- Confirm that the transit bars have been removed with the *OK* sensor control.

The display will change to the next setting.

5. Setting up TwinDos

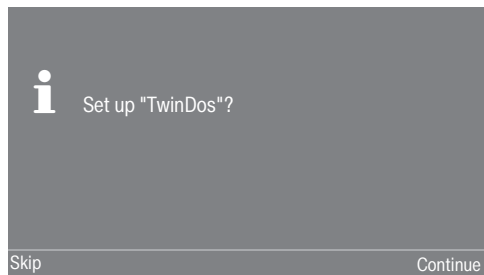

- Touch the **Continue** sensor control to set TwinDos up straight away.

Tip: To postpone setup until later: touch the **Skip** sensor control. The following message will then appear in the display:

i It is possible to set up later in "Settings" / "TwinDos".

Confirm with the **OK** sensor control.

Setting up compartment ①

The procedure for Miele UltraPhase 1 and Miele UltraPhase 2 is described below. The procedure for other detergents is similar.

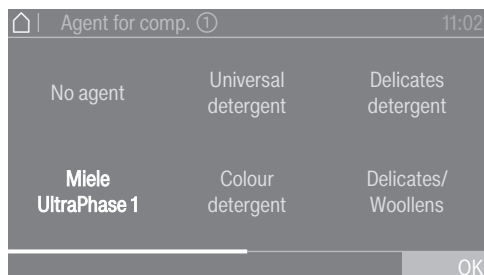

- Touch the **Miele UltraPhase 1** sensor control.



The following message will then appear in the display:

i Please enter the dosing recommendation of your detergent for a wash with normal soiling. Take note of your water hardness level.

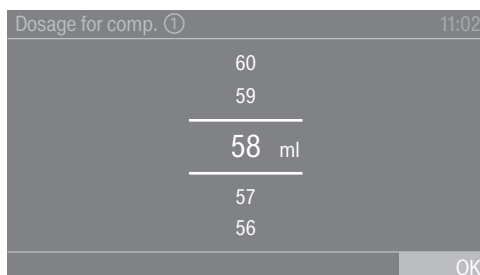
The dispensing quantity for UltraPhase 1 is preset for  (**water hardness level II**).



- Confirm the preset value with the **OK** sensor control, or change the value.

UltraPhase 1		
	Water hardness level I	46 ml
	Water hardness level II	58 ml
	Water hardness level III	70 ml

The following will appear in the display:

i Insert container ①

Before using for the first time

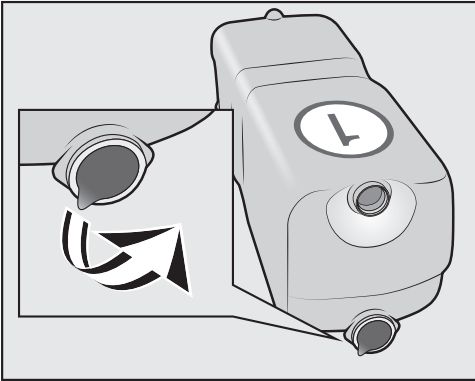

- Remove the foil from the detergent cartridge.

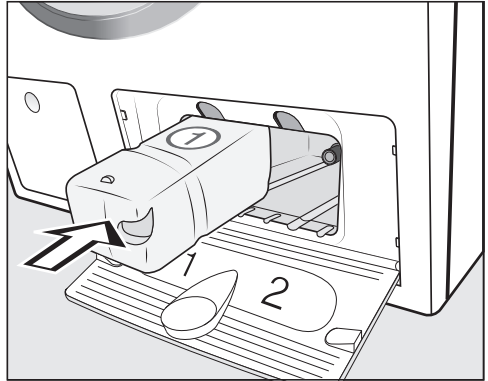

- Push the UltraPhase 1 detergent cartridge into compartment 1 until it locks into position.

The following message will then appear in the display:

- i** Now enter the settings for UltraPhase 2

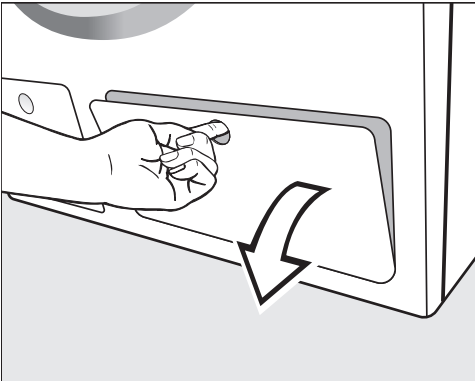

- Open the access panel for TwinDos.



Before using for the first time

Setting up compartment ②

The dispensing quantity for UltraPhase 2 is preset for  (water hardness level II).

Dosage for comp. ②		11:02
	47	
	46	
	<hr/>	
	45 ml	
	<hr/>	
	44	
	43	
		OK

- Confirm the preset value with the OK sensor control, or change the value.

UltraPhase 2		
	Water hardness level I	36 ml
	Water hardness level II	45 ml
	Water hardness level III	54 ml

The following will appear in the display:

- i** Insert container ②

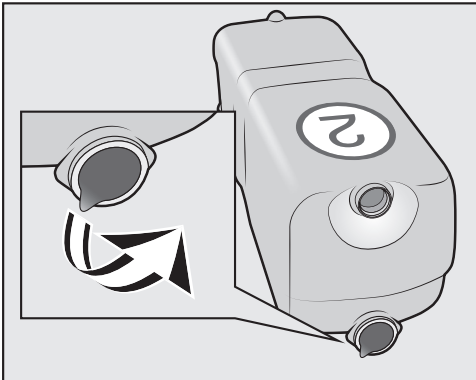

- Remove the foil from the detergent cartridge.

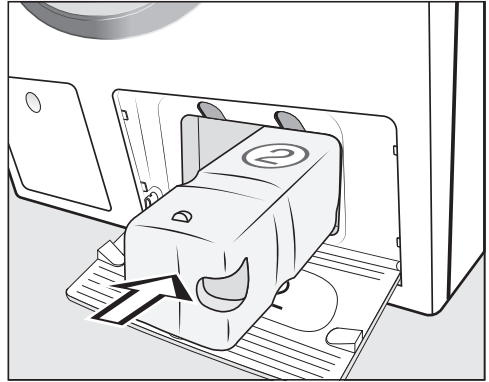

- Push the UltraPhase 2 detergent cartridge into compartment 2 until it locks into position.

The following message will then appear in the display:

i "TwinDos" is set up. Changes can be made in "Settings" / "TwinDos".

- Confirm with the OK sensor control.
- Close the TwinDos access panel.

The display will then change to the calibration programme.

Before using for the first time

6. Starting the calibration programme

It is important to calibrate the washer-dryer to ensure optimum water and energy usage, as well as optimum washing and drying results.

To do this, the *Cottons* programme **must** be run without laundry.

No other programmes can be started until calibration has been carried out.

The following message will then appear in the display:

i Open the stopcock and start the *Cottons* 90°C programme with an empty drum

■ Confirm with the *OK* sensor control.

The display will then change to the standard menu for the *Cottons* programme.

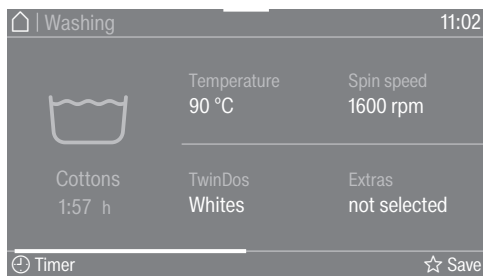

■ Open the stopcock.

■ Touch the *Start/Stop* sensor control.

The washer-dryer calibration programme will start. The duration will be approximately 2 hours.

At the end of the programme, the following message will appear in the display:

i Set up complete

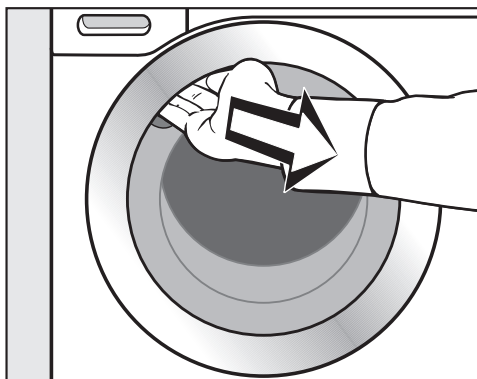

■ Reach under the recessed grip and pull the door open.

Tip: Leave the door slightly open to allow the drum to dry.

■ Switch the washer-dryer off with the  button.

Environmentally friendly washing and drying

Energy and water consumption

- Use the maximum load size for the current programme. The energy and water consumption will then be the lowest in relation to the size of the load.
- Programmes that are more efficient with regard to energy and water consumption generally have a longer programme running time. By extending the programme running time, the wash temperature that is actually reached can be reduced while still providing the same wash results. For example, the ECO 40-60 programme has a longer running time than the Cottons 40 °C or 60 °C programme. The ECO 40-60 programme is more efficient in terms of energy and water consumption.
- Use the Express 20 programme for small, lightly soiled loads.
- Modern detergents make it possible to wash at lower temperatures (e.g. 20 °C). Using lower temperature settings will save energy.
- To maintain the hygiene of the washer-dryer, carry out a hot wash (above 60 °C) at regular intervals. The message Hygiene info: Select "Maintenance" and run the "Clean machine" programme. will appear in the display of the washer-dryer to remind you to carry out a hot wash.

Detergent

- For precise dispensing use automatic detergent dispensing.
- Adjust the dosage to the degree of soiling of the laundry.
- Do not exceed the amounts of detergent recommended by the manufacturer on the packaging.

When drying with a tumble dryer

To save energy when tumble drying, select the highest possible spin speed for the wash programme and for the thermo-spin.

WASHING

1. Prepare the laundry

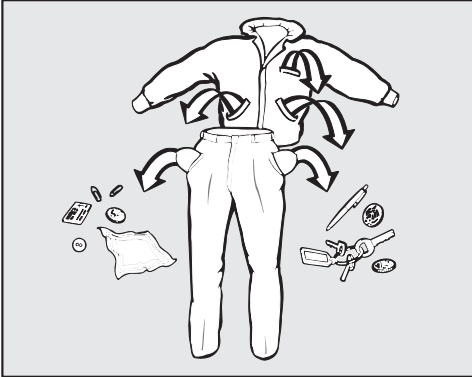

- Empty all pockets.

⚠ Damage due to foreign objects.

Nails, coins, paper clips, etc. can cause damage to garments and components inside the machine. Check laundry before washing and remove any foreign objects.

Sort the laundry

- Sort the laundry by colour and by care label. Most garments have a textile care label in the collar or side seam.

Tip: Dark textiles often contain excess dye and should be washed separately several times before being included in a mixed load. Always wash whites and colours separately.

Pre-treating stains

- Badly soiled areas and stains should be cleaned as soon as possible, preferably whilst still fresh. Stains should be carefully dabbed off using a soft, colourfast cloth. Do not rub.

⚠ Damage due to solvent-based cleaning agents.

Cleaning agents containing benzene, stain remover, etc. can damage plastic parts.

When pre-treating textiles, make sure that plastic parts do not come into contact with the cleaning agent.

⚠ Risk of explosion due to solvent-based cleaning agents.

If solvent-based cleaning agents are used, an explosive mixture can form. Never use solvent-based cleaning agents in the washer-dryer.

General tips

- Curtains: remove rollers and lead weights or place in a laundry bag.
- Sew in or remove any loose underwiring in bras.
- Close any zips, attach velcro fasteners, fasten hooks and eyes, etc. before washing.
- Fasten duvet covers and pillow cases to prevent small items from becoming rolled up inside them.

Do not wash items which are specified by the manufacturer as **not washable** according to the symbol on the care label (☒ symbol).

2. Select a programme

Switching the washer-dryer on

- Press the  button.

The drum lighting will come on.

The drum lighting will go out automatically after a few minutes.

Tip: To switch the lighting on again, open the pull-down menu from the overview menu and then touch the  sensor control.

The main menu will then appear in the display.

Selecting a programme

- Touch the  Washing sensor control.

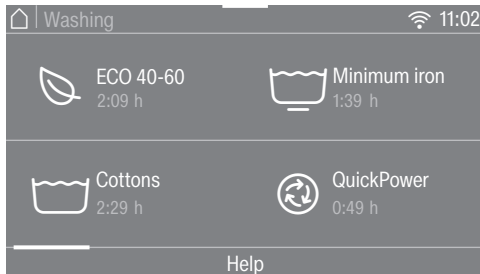

- Scroll to the right in the display until the programme you want appears.
- Touch the sensor control for that programme.

The display will then change to the standard menu for the programme.

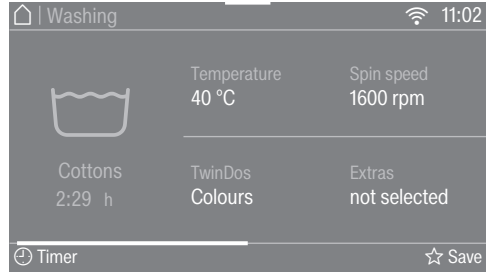

There are 3 other ways to select a programme:

- Saved favourite programmes
- The washing/drying assistant
- Miele MobileStart

WASHING

3. Selecting programme settings

Selecting a temperature

You can alter the preset temperature of a wash programme.

The temperatures reached inside the washer-dryer might not be the same as the temperatures selected. Perfect wash results are achieved through a combination of energy use and wash duration.

- Touch the **Temperature sensor control**.
- Select the desired temperature.

The display will change to the standard menu for that wash programme.

Selecting a spin speed

You can alter the preset spin speed of a wash programme.

- Touch the **Spin speed sensor control**.
- Select the spin speed you want.

The display will change to the standard menu for that wash programme.

Activating TwinDos

TwinDos dispensing is automatically activated for all programmes in which dispensing is possible.

1. Switch TwinDos on or off

- Touch the **TwinDos sensor control** and select **Off** or **On**.

2. Select the detergent

When using Miele's 2-phase system you must set the colour of the laundry.

- Select **Whites** for loads of white items, or **Colors** for loads containing coloured items.

If using a different type of detergent, this must be selected.

- Select compartment ① or ②.

Tip: Only those detergents that can be used with the programme are displayed.

3. Select the degree of soiling

The display will ask you to enter the degree of soiling of the laundry.

- Select **Light**, **Normal** or **Heavy**.
- Confirm your choice with the **OK sensor control**.

TwinDos is switched on.

The display will change to the standard menu for that wash programme.

See "Washing" – "5. Add detergent" – "TwinDos" for more information.

Selecting Extras

You can supplement the wash programmes with Extras.

- Touch the **Extras** sensor control.
- Select one or more Extras.

Not all Extras can be combined. Extras that cannot be combined are greyed out and cannot be selected.

- Confirm with the **OK** sensor control.

The display will change to the standard menu for that wash programme.

See “Washing” – “Extras” for more information.

Activating CapDosing

You can use CapDosing with this wash programme.

- Touch the **CapDosing** sensor control.

The types of capsules which can be used with the programme will appear in the display.

- Select the type of capsule you want.

CapDosing is now active.

The display will then change to the standard menu.

See “Washing” – “5. Add detergent” – “CapDosing” for more information.

Selecting stains

In order to clean stained laundry more effectively, you can choose from a list of various types of stains. The wash programme will then adapt to the type of stain selected.

- Touch the **Stains** sensor control.

- Select the types of stains in your load from the list.

- Confirm your choice with the **OK** sensor control.

With some stains, helpful information will also appear in the display when they are selected.

- Confirm the information with the **OK** sensor control.

The display will then change to the standard menu.

Timer ⌚

You can use the Timer to set the finish time or the start time for a programme.

See “Timer/SmartStart” for further information.

WASHING

4. Loading the washer-dryer

Opening the door

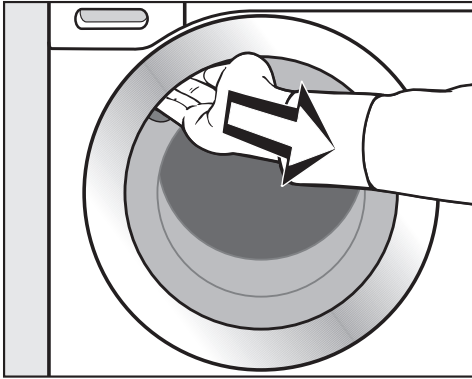

- Reach under the recessed grip and pull the door open.

Check the drum for pets or foreign objects before loading it with laundry.

- Unfold the laundry and load loosely into the drum.

Mixing both large and small items gives better wash results and also helps to distribute the load evenly during spinning.

The most efficient use of energy and water consumption is achieved when a full load is washed. However, do not overload as this reduces cleaning efficiency and causes creasing.

Tip: The maximum load size for the programme selected will appear in the pull-down menu.

Closing the door

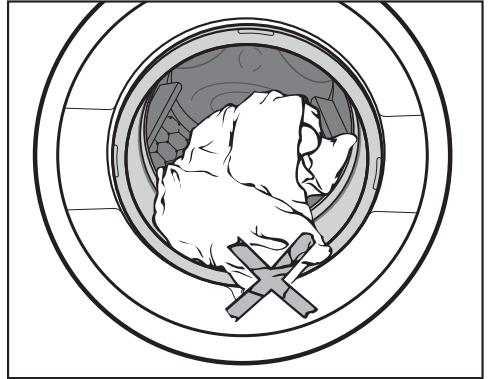

- Make sure that no items are caught between the door and the seal.

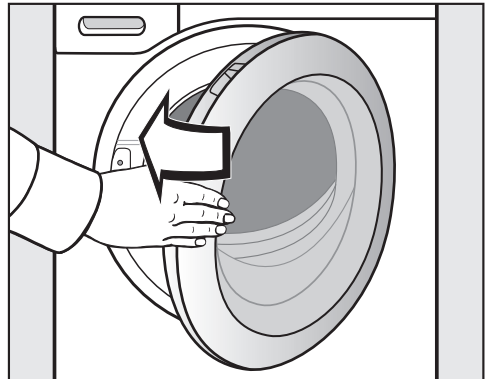

- Shut the door with a gentle swing.

5. Add detergent

Detergent can be dispensed via TwinDos **A**, via the detergent dispenser drawer **B** or with Caps **C**.

A TwinDos

The washer-dryer has the TwinDos system.

TwinDos must be activated; see “Before using for the first time”.

How UltraPhase 1 and UltraPhase 2 work

UltraPhase 1 is a liquid detergent which dissolves dirt and removes the most common stains. UltraPhase 2 is a bleaching agent and removes stubborn stains. For the best wash results, these two agents are dispensed at separate times during the washing process. UltraPhase 1 and UltraPhase 2 clean white and coloured fabrics thoroughly. UltraPhase 1 and UltraPhase 2 single-use cartridges are available from www.shop.miele.com or a Miele dealer.

Activating TwinDos dispensing

TwinDos dispensing is automatically activated for all programmes in which dispensing is possible.

Tip: The detergent dispensing quantities are preset. If too much foam builds up, the dispensing quantity can be reduced via the  *Settings* menu, *Programme sequence*, *TwinDos*.

Changing TwinDos dispensing

You can change the suggested colour composition of the laundry.

- Touch the TwinDos sensor control and select the colour composition of your laundry.

Deactivating TwinDos dispensing

- Touch the TwinDos sensor control.
- Touch the Off sensor control.

Replacing detergent cartridges

Make sure the washer-dryer is switched on before replacing the detergent cartridge. This will ensure that the counter is set to 0 and the fill level indicator is correct.

- Switch the washer-dryer on.

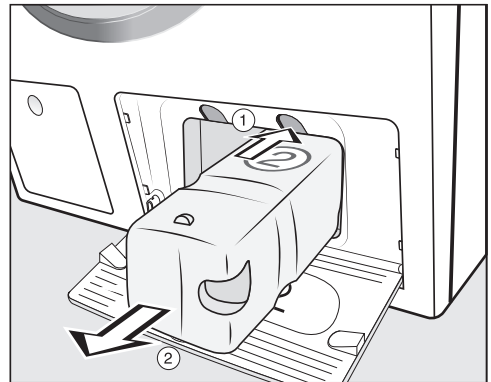

- ① Press the yellow button above the detergent cartridge.

The locking mechanism is released.



- ② Remove the empty detergent cartridge.

- Place a new detergent cartridge in the compartment.

WASHING

Selecting the degree of soiling

The degree of soiling in laundry is divided into 3 settings:

-  Light
No visible soiling or stains
-  Normal
Visibly soiled and/or just a few slight stains
-  Heavy
Heavily soiled and/or stains clearly visible

The dispensing amount for TwinDos and the amount of water required for rinsing is preset for the  Normal degree of soiling.

- Touch the TwinDos sensor control to select a different level of soiling.

The amount of detergent and water will be adjusted to suit the selected degree of soiling.

Some programmes will not let you set the degree of soiling. These programmes are designed for lightly soiled laundry only.

Using other methods to remove stains

If you wish to use additional methods of stain removal, you have the following options:

- Using the Booster capsule and activating CapDosing
- Adding stain remover to the  compartment in the detergent drawer

B Detergent drawer

Any detergent suitable for domestic washing machines can be used. Please observe the instructions for use and dosage on the detergent packaging.

Ensure that TwinDos dispensing is deactivated.

Adding detergent

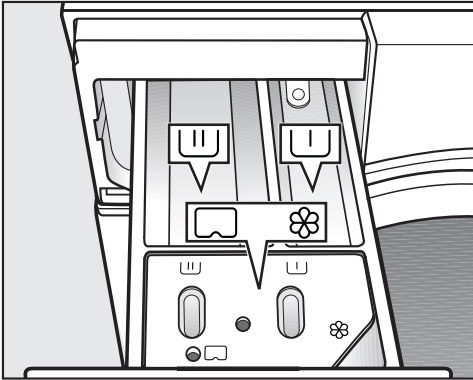

- Pull out the detergent drawer and add detergents to the compartments.

- U Detergent for the pre-wash
- U Detergent for the main wash and soaking
- ⊗ Fabric conditioner, liquid starch or capsules

Using liquid detergents with a pre-wash

Liquid detergent cannot be used for the main wash if the pre-wash has been selected.

Use powder detergent for the main wash.

Using detergent tablets or pods

Always put detergent tablets or pods directly in the drum with the laundry. They cannot be added via the detergent drawer.

WASHING

Adding fabric conditioner

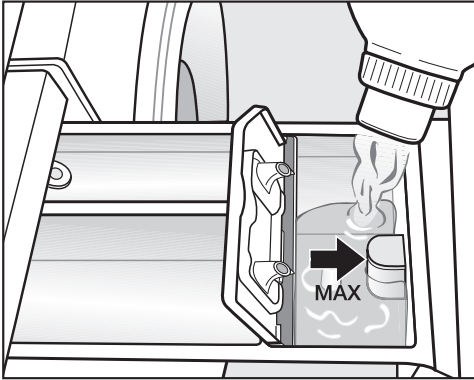

- Add fabric conditioner or liquid starch to the ☼ compartment. **Do not exceed the maximum level mark.**

This will be automatically dispensed in the final rinse cycle. At the end of the wash programme a small amount of water remains in the ☼ compartment.

If starching frequently, thoroughly clean the detergent drawer, especially the siphon, regularly.

Tips on dispensing

Adjust the detergent dosage to the degree of soiling of the laundry and the load size. Reduce the amount of detergent with smaller load sizes (e.g. reduce the amount of detergent by $\frac{1}{3}$ when washing a half load).

Too little detergent:

- Results in laundry not being cleaned properly and may cause it to become grey and hard to the touch over time
- Can lead to a build-up of mould in the washer-dryer
- Results in grease not being completely removed from the laundry
- Can lead to limescale deposits on the heater elements

Too much detergent:

- Causes poor wash, rinse and spin results
- Causes higher water consumption as an extra rinse cycle is automatically activated
- Is a greater burden on the environment

See “Washing” – “Detergent” for further information about detergents and how much to dispense.

© CapDosing

If you selected CapDosing when setting the programme, detergent will be dispensed via the capsule for this wash programme.

Only one capsule can be selected per wash programme.

3 different types of capsule are available:

- ☼ = Fabric care (e.g. fabric conditioner, proofing agent)
- 🧴 = Additives (e.g. detergent enhancer)
- 💧 = Detergent (for the main wash only)

Each capsule contains the correct amount for one wash cycle.

Caps are available from www.shop.miele.com, the Miele Customer Service Department or your Miele dealer.

⚠ Capsules pose a health risk. The ingredients of capsules can be hazardous to health if they are swallowed or come into contact with skin. Keep capsules out of the reach of children.

Inserting a capsule

- Open the detergent drawer.

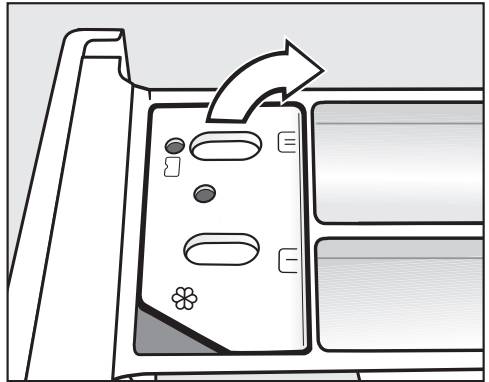

- Open the lid of the ☼/🧴 compartment.

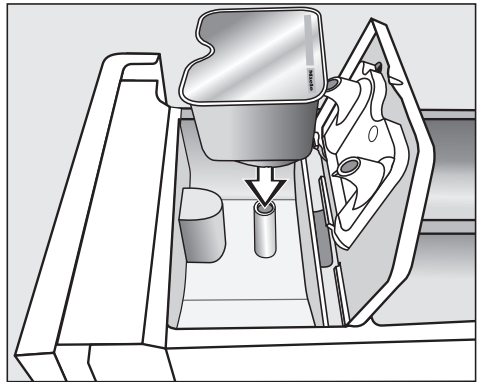

- Press the capsule in firmly.

WASHING

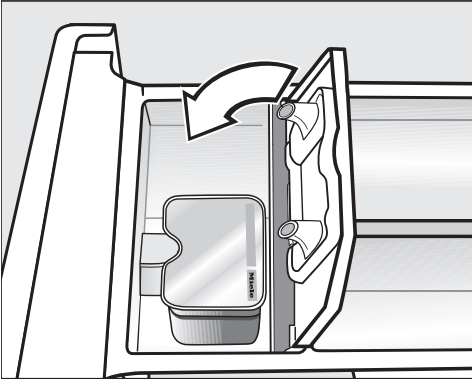



- Remove the empty capsule at the end of the programme.

For technical reasons, a small amount of water will remain in the capsule.

- Close the lid and press it firmly shut.
- Close the detergent drawer.

The capsule is opened by the act of inserting it into the detergent drawer. The contents can run out of the capsule if you then remove it from the detergent drawer before it is used. Dispose of the capsule and do not re-use it.

The wash programme will dispense the contents of the capsule at the correct time.

When using CapDosing, water intake to the  compartment takes place solely via the capsule. When using capsules, do not add fabric conditioner to the  compartment.

6. Starting the programme

The programme can be started when the *Start/Stop* sensor control is flashing on and off.

- Touch the *Start/Stop* sensor control.

The door will lock and the wash programme will start.

The programme status will appear in the display.

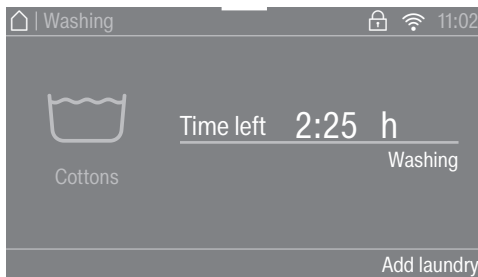

The washer-dryer will keep you updated on the programme stage and the duration remaining for the programme to run.

If a delay start period has been selected, this will appear in the display.

Saving energy

After 10 minutes, the indicators dim. The *Start/Stop* sensor control flashes slowly.

To reactivate the indicators:

- Touch the *Start/Stop* sensor control (this does not have any effect on a programme that is running).

Adding laundry - AddLoad

Laundry can be added or removed if Add laundry is illuminated in the display.

- Touch the Add laundry sensor control.

The following will appear in the display:

⋮ Please wait

The programme will stop and the door will unlock.

- Open the door.
- Add or remove laundry.
- Close the door.
- Touch the *Start/Stop* sensor control.

The programme continues.

Please note:

Once a programme has started, the washer-dryer cannot recognise any adjustment to the load.

For this reason, if laundry is added or removed after the start of a programme, the machine will always complete the programme cycle assuming a full load.

WASHING

7. End of the programme/unloading laundry

In the anti-crease phase, the drum continues to turn for up to 30 min after the end of the programme. The door will lock and the following will appear in the display: Finish/Anti-crease and Unlock with "Start/Stop".

- Press the *Start/Stop* button.

The door will unlock.

The door unlocks automatically at the end of the anti-crease phase.

- Pull open the door.
- Remove the laundry.

Items left in the drum could discolour other items in the next wash or become discoloured themselves. Remove all items from the drum.

- If applicable, remove the used capsule from the detergent drawer.
- Switch the washer-dryer off with the  button.

Tip: See “After each washing or drying programme”.

Spin speeds

Programme	rpm
ECO 40–60	1600
Cottons	1600
Minimum iron	1200
QuickPower	1600
Delicates	900
Shirts	900
Woolens	1200
Denim	900
Outerwear	800
Proofing	1000
Curtains	600
Express 20	1200
Sportswear	1200
Dark garments	1200
Trainers	600
Silks	600
Down filled items	1200
Pillows	1200
Cottons hygiene	1600
Automatic plus	1400
First wash	1200
Drain/Spin	1600
Separate rinse	1600
Starch	1600
Cottons 	1600

Final spin speed in wash programme

When a programme is selected, the optimum spin speed for this wash programme is shown in the display.

A faster spin speed can be selected for certain wash programmes.

The highest selectable spin speed is indicated in the table.

Omitting the final spin (Rinse hold)

- Select the **Rinse hold Extra**.

The laundry is not spun after the final rinse cycle and remains in the rinse water. This helps prevent creasing if the laundry is not going to be removed from the drum immediately after the end of the programme.

To start the final spin:

The wash programme is set to the optimum spin speed. You can change the spin speed.

- Touch the **Change spin speed sensor control**.
- Select the desired spin speed.
- Start the final spin with the **Start/Stop** control.

Ending the programme:

- Touch the **Change spin speed sensor control**.
- Select the spin speed 0 rpm (no spin).
- Touch the **Start/Stop** sensor control.

The water will be pumped away.

Rinse-spin

There is a spin cycle after the main wash and between the rinse cycles. A reduction in the final spin speed will also reduce the rinse-spin speed as appropriate.

Omitting the rinse-spin and the final spin

- Touch the **Spin speed sensor control**.
- Select the spin speed 0 rpm (no spin).

After the last rinse, the water will be pumped away and the anti-crease phase will switch on.



In some programmes an extra rinse is introduced with this setting.

WASHING

Programme chart

ECO 40–60		Max. load 8.0 kg
Items	Normally soiled cotton garments	
Tip	<ul style="list-style-type: none"> - A laundry load consisting of mixed cottons that are intended for washing at 40 °C or 60 °C can be washed in the same wash cycle. - This programme is the most efficient in terms of energy and water consumption for washing cottons. 	
<p>Note for test institutes: test programme for compliance with EU legislation regarding ecodesign No. 2019/2023 and energy labelling in accordance with Regulation No. 2019/2014.</p> <p>TwinDos dispensing must be deactivated when carrying out comparison tests.</p>		
Cottons		90 °C to cold
Max. load 8.0 kg		
Items	Cotton, linen or mixed fibre fabric, e.g. table linen, underwear, T-shirts, etc.	
Tip	- Where particularly high levels of hygiene are required, please select a temperature of 60 °C or higher.	
Minimum iron		60 °C to cold
Max. load 3.5 kg		
Items	Synthetic and mixed fibre fabric and easy care cotton	
Tip	Reduce the spin speed for items which crease easily.	
QuickPower		60 °C to 40 °C
Max. load 4.0 kg		
Items	Moderately soiled garments which are also suitable for washing in the <i>Cottons</i> programme	
Tip	A special wetting process and wash rhythm ensure that the laundry is cleaned particularly quickly and thoroughly.	
Delicates		60 °C to cold
Max. load 2.0 kg		
Items	Delicate garments made from synthetic fibre, mixed fibre and viscose	
Tip	Deselect the spin speed for items which crease easily.	

WASHING

Shirts		60 °C to cold	Max. load 1.0 kg/2.0 kg
Items	Shirts and blouses made of cotton and mixed fibre		
Tip	<ul style="list-style-type: none"> - Pre-treat collars and cuffs depending on the level of soiling. - Turn shirts and blouses inside out, do up buttons and turn collars and cuffs inwards. - Wash silk shirts and blouses in the <i>Silks</i>  programme. - If the <i>Pre-ironing Extra</i> is switched on, the maximum load capacity is decreased to 1.0 kg. 		
Woollens 		40 °C to cold	Max. load 2.0 kg
Items	Wool or wool blend fabric		
Tip	Reduce the final spin speed for fabric that creases easily.		
Denim		60 °C to cold	Max. load 3.0 kg
Tip	<ul style="list-style-type: none"> - Wash denim inside out. - Denim often contains excess dye and may run during the first few washes. Therefore, wash light and coloured items separately. - Close any zips, do up buttons, etc. before washing. 		
Outerwear		40 °C to cold	Max. load 2.5 kg
Items	Functional textiles such as outdoor jackets and trousers made from membrane fabrics such as Gore-Tex [®] , SYMPATEX [®] , WINDSTOPPER [®] , etc.		
Tip	<ul style="list-style-type: none"> - Zip up or close any jackets with velcro fasteners before washing. - Do not use fabric conditioner. - If required, outdoor clothing can be re-proofed in the <i>Proofing</i> programme. Proofing after each wash cycle is not recommended. 		





WASHING

Proofing		40 °C	Max. load 2.5 kg
Items	For treating microfibre fabric, ski wear or table linen made from mainly synthetic fibres to provide a finish which is resistant to water and dirt		
Tip	<ul style="list-style-type: none"> - The items should be freshly laundered and spun or dried before proofing. - For best results, the items should be heat-treated afterwards. This can be achieved by drying them in the washer-dryer or ironing them. 		
Curtains		40 °C to cold	Max. load 2.0 kg
Items	Curtains specified as machine-washable by the manufacturer		
Tip	<ul style="list-style-type: none"> - Select the <i>Pre-wash</i> option to remove dust. - For curtains which crease easily, reduce the spin speed or deselect the spin. - Remove weights from curtains. 		
Express		40 °C to cold	Max. load 3.5 kg
Items	Cotton garments that have hardly been worn or are only very lightly soiled		
Sportswear		60 °C to cold	Max. load 2.5 kg
Items	Sportswear such as singlets and leggings as well as microfibre and fleece garments		
Tip	<ul style="list-style-type: none"> - Do not use fabric conditioner. - Follow the instructions on the care label. 		
Dark garments		60 °C to cold	Max. load 3.0 kg
Items	Black and dark items made of cotton or mixed fibres		
Tip	Wash inside out.		

WASHING

Trainers		40 °C to cold	Max. 2 pairs
Items	Sports shoes only (not leather shoes)		
Tip	<ul style="list-style-type: none"> - The manufacturer's care label must be observed. - Do not use fabric conditioner. - Coarse soiling should be brushed off first. - A pre-rinse without detergent is carried out automatically to remove dust. 		
Silks 		30 °C to cold	Max. load 1.0 kg
Items	Silks and other handwashable fabrics with no wool content		
Tip	Place tights, bras, etc. in a laundry bag.		
Down filled items		60 °C to cold	Max. load 2.0 kg
Items	Jackets, sleeping bags, pillows and other items with down filling		
Tip	<ul style="list-style-type: none"> - Remove air from the laundry before washing to prevent an excessive build-up of foam. To do this either push the laundry items into a narrow laundry bag to compress them or tie them together with a washable strap. - Follow the instructions on the care label. 		
Pillows		60 °C to cold	2 pillows (40 x 80 cm) or 1 pillow (80 x 80 cm)
Items	Synthetic filled washable pillows		
Tip	<ul style="list-style-type: none"> - Remove air from the laundry before washing to prevent an excessive build-up of foam. To do this either push the laundry items into a narrow laundry bag to compress them or tie them together with a washable strap. - Follow the instructions on the care label. 		
Cottons hygiene		90 °C to 60 °C	Max. load 8.0 kg
Items	Cotton or linen with direct skin contact or for items which have special hygiene requirements, e.g. underwear, bed linen, encasing products		
Tip	Observe the instructions on the care label.		

WASHING



Automatic plus		40 °C to cold	Max. load 5.0 kg
Items	Mixed loads of garments suitable for the <i>Cottons</i> and <i>Minimum iron</i> programmes		
Tip	The wash parameters (e.g. water level, wash rhythm and spin speed) are adjusted automatically in this programme to ensure the best possible care and cleaning efficiency for each item.		
First wash		40 °C to cold	Max. load 2.0 kg
Items	New items made of cotton, synthetic fibres and towelling		
Tip	Use this programme to wash any manufacturing residues out of new items.		
Drain/Spin			Max. load 8.0 kg
Tip	<ul style="list-style-type: none"> - Drain only: select 0 rpm for the spin speed. - Make sure you select the appropriate spin speed. 		
Separate rinse			Max. load 8.0 kg
Items	Rinsing hand-washed items		
Tip	Reduce the final spin speed for items which crease easily.		
Starch			Max. load 8.0 kg
Items	Table cloths, serviettes and workwear requiring starching		
Tip	<ul style="list-style-type: none"> - Reduce the final spin speed for items which crease easily. - Laundry that is to be starched should be washed, but not treated with fabric conditioner. 		
Cottons 		 / 	Max. load 8.0 kg
Items	Normally soiled cotton garments		
Tip	<ul style="list-style-type: none"> - These settings are the most efficient in terms of energy and water consumption for washing cottons. - With , the wash temperature reached is below 60 °C. The wash performance is the same as with the Cottons 60 °C programme. 		
Note for test institutes: test programmes in accordance with EN 60456.			

Programme sequence

	Main wash		Rinsing		Spin
	Water level	Wash rhythm	Water level	Rinse cycles	
ECO 40–60		Ⓐ		2–3 ²	✓
Cottons		Ⓐ		2–5 ^{1,2,3}	✓
Minimum iron		Ⓑ		2–4 ^{2,3}	✓
QuickPower		Ⓐ		2	✓
Delicates		Ⓒ		2–4 ^{2,3}	✓
Shirts		Ⓒ		3–4 ³	✓
Woollens		Ⓔ		2	✓
Denim		Ⓑ		2–4 ^{2,3}	✓
Outerwear		Ⓒ		3–4 ³	✓
Proofing	–	Ⓑ		1	✓
Curtains		Ⓒ		3–4 ³	✓
Express 20		Ⓐ		1	✓
Sportswear		Ⓒ		2–3 ³	✓
Dark garments		Ⓑ		3–5 ^{2,3}	✓
Trainers ⁴		Ⓓ		2	✓
Silks		Ⓔ		2	✓
Down-filled items ⁵		Ⓒ		3–4 ³	✓
Pillows ⁵		Ⓒ		3–4 ³	✓
Cottons hygiene		Ⓐ		3–5 ^{2,3}	✓
Automatic plus		Ⓐ Ⓑ		2–4 ^{2,3}	✓
First wash		Ⓑ		2–3 ³	✓
Separate rinse	–	–		2	✓
Starch		Ⓑ	–	–	✓

Please see the next page for a description of the symbols.

WASHING

-  = low water level
-  = medium water level
-  = high water level
- Ⓐ = intensive rhythm
- Ⓑ = normal rhythm
- Ⓒ = sensitive rhythm
- Ⓓ = ultra sensitive rhythm
- Ⓔ = handwash rhythm
- ✓ = carried out
- = not carried out

This washer-dryer has fully electronic controls with automatic load control. It takes in the right amount of water required for the programme depending on the amount of laundry and its absorbency rate.

The programme sequences outlined are based on the standard programme with a full load.

The washer-dryer's display continually shows which programme stage has been reached.

Special features in the programme sequence

Anti-crease:

At the end of the programme, the drum continues to turn for up to 30 minutes to help prevent creasing.

Exception: there is no anti-crease phase in the *Woollens* and *Silks* programmes.

The washer-dryer can be opened at any time.

¹ If a temperature of 60 °C or higher is selected, 2 rinses are carried out. If a temperature of less than 60 °C is selected, 3 rinses are carried out.

² An extra rinse is carried out if:

- There is too much foam in the drum
- The final spin speed is less than 700 rpm

³ An extra rinse is carried out if:

- The Extra rinse Extra has been selected.

⁴ Pre-wash:

- A pre-wash is carried out automatically to remove dust.

⁵ Spin speed increase:

- A spin speed increase is carried out before the wash process begins to deflate the filling.

PowerWash

PowerWash is a washing technique developed by Miele which is activated in the following wash programmes:

- ECO 40–60 (with small and medium load sizes)
- Cottons (with small and medium load sizes)
- QuickPower
- Minimum iron
- Shirts
- Automatic plus
- Delicates

How it works

Conventional washing techniques wash with more water than the laundry can absorb. This total volume of water needs to be heated.

The PowerWash washing technique only uses slightly more water than the laundry can absorb. The water which has not been absorbed by the laundry heats up the drum and the laundry and is sprayed into the laundry over and over again. This reduces energy consumption.

Activation

PowerWash is activated **automatically** in the programmes listed above.

PowerWash is deactivated if:

- The selected final spin speed is less than 600 rpm
- CapDosing has been selected for the main wash (☺, ☹)

- The wash temperature is higher than 60 °C
- Extras such as *Pre-wash* or *Water plus* have been selected
- A large load size is being washed in the *Cottons* programme

Special features

- Drenching phase

The washer-dryer will spin a few times at the beginning of the wash programme. During the spin cycle, the water discharged is sprayed back into the laundry in order to achieve optimum wetting.

The optimum water level is set at the end of the drenching phase. If necessary, the machine will pump water away and take in a little more fresh water.

- Noises during the heating phase

Unusual bubbling noises can occur while the laundry and the drum are being heated.

WASHING

Extras

You can supplement the wash programmes with Extras.

Not all Extras can be selected with every wash programme.

Selecting Extras

- Touch the **Extras** sensor control.
- Select one or more Extras.

Not all Extras can be combined. Extras that cannot be combined are greyed out and cannot be selected.

- Confirm with the **OK** sensor control.

The display will change to the standard menu for that wash programme.

SingleWash

For efficiently washing a very small load size (< 1 kg) in a normal wash programme. The wash duration is reduced.

Please note the following advice:





- Use liquid detergent.
- Reduce the dosage to a maximum of 50 % of the amount quoted for a ½ load.

Extra gentle

Drum rotation and wash duration are reduced. Lightly soiled fabrics are washed more gently.

Pre-ironing

In order to reduce creasing, the laundry undergoes a smoothing process at the end of the programme. Reducing the maximum load size by 50 % will achieve a better result. Small load sizes achieve a better result.

The garments must be suitable for drying in a tumble dryer   and suitable for ironing  .

The spin speed is reduced for some programmes.

Quick

For textiles with light soiling with no visible stains.

The duration of the main wash is reduced.

Water plus

The water level in the main wash and the rinses will be increased. A second rinse cycle is carried out in the **Separate rinse** programme.

You can select other functions for the **Water plus** Extra. These are described in “Settings”.

Pre-wash

For laundry with large amounts of dirt, e.g. dust and sand.

Soak

For heavily soiled and stained items with protein stains.





A soak duration of between 30 minutes and 5 hours in 30-minute increments can be selected. See “Settings” for more information.

The factory default setting is 30 minutes.

Intensive

For hard-wearing laundry that is very heavily soiled. Cleaning efficiency is increased through more intense mechanical action and the application of more heat energy.

AllergoWash

This option should be used where especially high standards of hygiene are required. More energy is used to lengthen the temperature holding times and more water is used to increase rinsing efficiency. The items must be suitable for drying in a tumble dryer   and suitable for ironing  .

Extra quiet

This option reduces noise levels during the wash programme. Use this if you want to wash during quiet periods (for instance when children are sleeping). The machine will activate the *Rinse hold* option and not spin. The programme running time is longer.

Rinse hold

The laundry is not spun after the final rinse cycle and remains in the rinse water. This helps prevent creasing if the laundry is not going to be removed from the drum immediately after the end of the programme.

Extra rinse

An extra rinse can be activated to achieve a better wash result.

WASHING

Detergent

All detergents produced for automatic washing machines are suitable. Follow the manufacturer's instructions and dosage recommendations on the packaging.

The dispensing quantity will depend on:

- The degree of soiling of the laundry
- The amount of laundry
- The water hardness

Check with your local water supplier if you do not know the water hardness level in your area.

Water softeners

A water softener can be used to cut down on the use of detergents in areas with water hardness levels II and III. Dispense according to the amount specified on the packaging. First add detergent and then the water softener.

You can then use the recommended amount of detergent for water hardness level I.

Water hardness levels

Hardness scale	Hardness level in mmol/l	German scale °d
I (soft)	0 – 1.5	0 – 8.4
II (medium)	1.5 – 2.5	8.4 – 14
III (hard)	above 2.5	above 14

Dispensing aids

Use dispensing aids, (e.g. balls) if these are supplied with the detergent, particularly when using liquid detergent.

Refill packs of detergent

When purchasing detergent buy refill packs wherever possible. This helps reduce the amount of waste packaging.

Fabric conditioners, liquid starch, starch

Fabric conditioners make garments soft to handle and help prevent static cling when tumble drying.



Liquid starch is synthetic and provides good stiffness to fabric.

Starch stiffens and gives body to fabric.

Using fabric conditioner, liquid starch or starch separately

Prepare the starch in accordance with the manufacturer's instructions on the packaging.

Tip: When adding fabric conditioner, activate the *Water plus Extra*.

- Add fabric conditioner to the  compartment or insert the appropriate capsule.
- Add liquid starch to the  compartment and powder or viscous starch to the  compartment.
- Select the *Separate rinse* programme.
- Change the spin speed if necessary.
- If using a capsule, touch the *CapDosing* sensor control and activate the *Cap*.
- Touch the *Start/Stop* sensor control.

Colour run and dye removers/dyes

 Damage due to colour run/dye removers.

Colour run and dye removers can cause corrosion in the washer-dryer. Do not use colour run or dye removers in this washer-dryer.



Dyes suitable for use in domestic washing machines can be used. However, please note that the salt used in the dyeing process can cause corrosion to stainless steel components in the machine if you use dye frequently. Always follow the dye manufacturer's instructions carefully.

When using the machine to dye fabric it is essential to select the *Water plus Extra*.

WASHING

Recommended Miele detergents

Miele detergents have been specially designed for day-to-day use in Miele washing machines. See “Detergents and care products” for more information about these detergents.

	Miele UltraPhase 1 and 2	Miele capsules		
				
ECO 40–60	✓	-	✓	✓
Cottons	✓	-	✓	✓
Minimum iron	✓	-	✓	✓
QuickPower	✓	-	-	-
Delicates	✓	✓	✓	-
Shirts	✓	-	✓	✓
Woollens	-	✓	-	-
Denim	✓	-	✓	-
Outerwear	-	✓	-	-
Proofing	-	-	✓	-
Curtains	✓	-	-	✓
Express 20	✓	-	✓	-
Sportswear	-	✓	-	-
Dark garments	✓	-	✓	-
Trainers	✓	-	-	✓
Silks	-	✓	-	-
Down filled items	-	✓	-	-
Pillows	-	✓	-	-
Cottons hygiene	✓	-	✓	✓
Automatic plus	✓	-	✓	✓
First wash	✓	-	✓	-
Separate rinse	-	-	✓	-

✓ Recommended

- Not recommended

 Special-purpose detergents (e.g. Wool-Care)

 Fabric care (e.g. fabric conditioner)

 Additive (e.g. booster)

Recommended detergents in accordance with Directive (EU) No. 1015/2010

The recommendations apply to the temperature ranges given in the section “Washing” in the Programme chart.

	Universal	Colour	Delicates and woollens	Special
	detergents			
ECO 40–60	✓	✓	–	–
Cottons	✓	✓	–	–
Minimum iron	–	✓	–	–
QuickPower	✓	✓	–	–
Delicates	–	–	✓	–
Shirts	✓	✓	–	–
Woollens	–	–	✓	✓
Denim	–	✓ ¹	–	✓
Outerwear	–	–	✓	✓
Proofing	–	–	–	✓
Curtains	✓ ²	–	–	✓
Express 20	–	✓ ¹	–	–
Sportswear	–	–	✓	✓
Dark garments	–	✓ ¹	–	✓
Trainers	–	✓ ¹	–	–
Silks	–	–	✓	✓
Down filled items	–	–	✓ ¹	✓
Pillows	–	–	✓ ¹	✓
Cottons hygiene	✓	✓	–	–
Automatic plus	–	✓	–	–
First wash	–	✓	–	–

✓ Recommended

– Not recommended

¹ Liquid detergent

² Powder detergent

DRYING

Separate drying

The separate drying programme should be run if the load in the wash programme is greater than the maximum load permitted for drying, or if you only want to dry part of the load that was washed.

1. Prepare the laundry

Sort the laundry

- Sort the laundry according to type of fibre/weave and the residual moisture content.

This will help you achieve an even drying result.

- Before drying, check the drying symbol on the care label.

If there is no care label, the article should only be tumble dried in a programme specially designed for it.

Tips on drying

- Do not load the drum with items that are still soaking wet. Spin the laundry for at least 30 seconds after washing.
- Woollens and wool blends are susceptible to becoming matted or shrinking. Only use the *Woollens* programme for these textiles.
- Pure linen should only be tumble dried if it is specified as suitable on the care label. The surface of the fabric may otherwise become rough.

- Jersey fabrics (e.g. T-shirts, underwear) tend to shrink when they are washed for the first time. Therefore, do not overdry the fabrics to prevent them from shrinking further. Buy jersey garments that are one or two sizes bigger.
- Starched laundry can be tumble dried. To achieve the usual finish, double the amount of starch should be used.
- New dark coloured garments should be washed and dried separately from light coloured garments. The colour of dark garments can run or fluff from garments of other colours may settle on them.
- Observe the maximum loads given for the drying programmes in the Programme chart. The drying result and amount of creasing depend on the size of the load. The smaller the load in the dryer, the better the result. Therefore, if you reduce the load, you will achieve a more even drying result with less creasing.

2. Select a programme

Switching the washer-dryer on

- Press the  button.

The drum lighting will come on.

The drum lighting will go out automatically after a few minutes.

Tip: To switch the lighting on again, open the pull-down menu from the overview menu and then touch the  sensor control.

The main menu will then appear in the display.

Selecting a programme

- Touch the Drying sensor control.

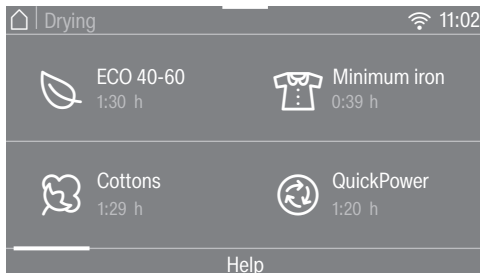

- Scroll to the right in the display until the programme you want appears.
- Touch the sensor control for that programme.

The display will then change to the standard menu for the programme.

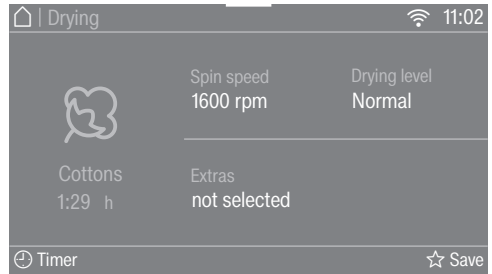

There are 3 other ways to select a programme:

- Saved favourite programmes
- The washing/drying assistant
- Miele MobileStart

DRYING

3. Selecting programme settings

Selecting a thermospin spin speed

The preset thermospin spin speed for a drying programme can be changed if required.

- Touch the **Spin speed** sensor control.
- Select the spin speed you want.

The display will change to the standard menu for that drying programme.

Selecting the drying level

You can alter the preset drying level for a wash programme.

- Touch the **Drying level** sensor control.
- Select the desired drying level.

The display will change to the standard menu for that wash programme.

Selecting Extras

You can supplement the wash programmes with Extras.

- Touch the **Extras** sensor control.
- Select one or more Extras.

Not all Extras can be combined. Extras that cannot be combined are greyed out and cannot be selected.

- Confirm with the **OK** sensor control.

The display will change to the standard menu for that wash programme.

See “Drying” – “Extras” for more information.

Timer

You can use the Timer to set the finish time or the start time for a programme.

See “Timer/SmartStart” for further information.

4. Loading the washer-dryer

Open the door

- Reach under the door grip and pull the door open.

Check the drum for pets or foreign objects before loading it with laundry.

- Load the laundry loosely in the drum.

Overloading places a strain on the textiles and affects drying results. Observe the maximum loads given in the “Programme chart”.

Close the door

- Make sure that no items are caught between the door and the seal.
- Shut the door with a gentle swing.

Detergent dispensing aids, e.g. plastic dispenser balls, can melt during the drying programme and cause damage to the machine and the laundry.

These dispensing aids must be removed from laundry before drying.

The water supply stopcock must be kept open for drying.

Tip: The maximum load size for the programme selected will appear in the pull-down menu.

5. Starting the programme

The programme can be started when the *Start/Stop* sensor control is flashing on and off.

- Touch the *Start/Stop* sensor control.

The door will lock and the wash programme will start.

The programme status will appear in the display.

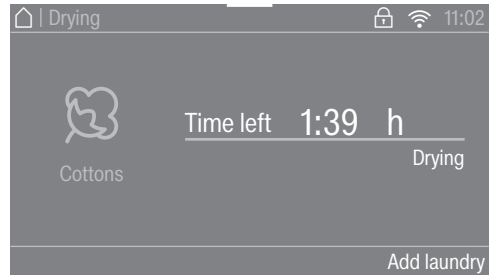

The washer-dryer will keep you updated on the programme stage and the remaining programme running time.

If a delay start period has been selected, this will appear in the display.

Saving energy

After 10 minutes, the indicators dim. The *Start/Stop* sensor control flashes slowly.

To reactivate the indicators:

- Touch the *Start/Stop* sensor control (this does not have any effect on a programme that is running).

Adding laundry - AddLoad

Laundry can be added or removed if Add laundry is illuminated in the display.

- Touch the *Add laundry* sensor control.

The following will appear in the display:

⋯ Please wait

The programme will stop and the door will unlock.

- Open the door.

DRYING

- Add or remove laundry.
- Close the door.
- Touch the *Start/Stop* sensor control.

The programme continues.

Please note:

Once a programme has started, the washer-dryer cannot recognise any adjustment to the load.

For this reason, if laundry is added or removed after the start of a programme, the machine will always complete the programme cycle assuming a full load.

6. End of the programme/unloading laundry

In the anti-crease phase, the drum continues to turn for up to 150 min after the end of the programme. The door will lock and the following will appear in the display: *Finish/Anti-crease and Unlock with "Start/Stop"*.

- Touch the *Start/Stop* sensor.

The door will unlock.

If you unload the laundry during the anti-crease phase, heat can build up. Spread the laundry out to cool it down.

The door unlocks automatically at the end of the anti-crease phase.

- Pull open the door.
- Remove the laundry.

Items left in the dryer could be damaged by overdrying when the dryer is used the next time. Remove all items from the drum.

Tip: See “After each washing or drying programme”.

Programme chart





* Weights are based on the weight of dry laundry.

¹ For further information on *Timed drying*, see the end of the Programme chart.

ECO 40-60		Max. load 5.0 kg*
Normal		
	Cotton textiles: T-shirts, underwear, baby clothes, workwear, jackets, covers, aprons, overalls, hand towels, bath towels, bathrobes and flannelette/bed linen	
Cottons		Max. load 5.0 kg*
Normal plus, Normal		
Use for	Single and multi-layered cotton textiles: T-shirts, underwear, baby clothes, workwear, jackets, covers, aprons, overalls, hand towels, bath towels, bathrobes and flannelette/bed linen	
Hand iron, Machine iron, Timed drying¹		
Use for	Cotton or linen fabric requiring further processing, e.g. table linen, bed linen, starched laundry	
Tip	To prevent laundry from drying out, it should be rolled up until you are ready for ironing.	
Minimum iron		Max. load 3.5 kg*
Normal plus, Normal, Hand iron, Timed drying¹		
Items	Minimum iron items made of cotton, synthetic or mixed fibre, e.g. workwear, overalls, jumpers, dresses, trousers, table linen, tights	
QuickPower		Max. load 4.0 kg*
Normal plus, Normal, Hand iron, Timed drying¹		
Use for	Items suitable for the <i>Cottons</i> programme	
Note	The programme running time for this programme is particularly short when washing and drying normally soiled laundry in a continuous sequence.	

DRYING

Delicates		Max. load 1.0 kg*
Normal plus, Normal, Hand iron, Timed drying¹		
Items	Delicate items with the  symbol on the care label made of synthetic fibres, artificial silk, easy care cotton or mixed fibres, e.g. shirts, blouses, lingerie and evening wear with sequins and beading.	
Tip	Reducing the load will reduce creasing.	
Shirts		Max. load 1.0 kg*
Normal plus, Normal, Hand iron, Timed drying¹		
Items	Shirts and blouses	
Tip	<ul style="list-style-type: none"> - Turn shirts and blouses inside out, do up buttons and turn collars and cuffs inwards. - The laundry is dampened before the programme starts to help reduce creasing. 	
Woollens		Max. load 2.0 kg*
3 minutes		
Items	Woollen garments and fabric containing wool blends, e.g. pullovers, cardigans, tights	
Tip	<ul style="list-style-type: none"> - Wool and wool blend items are only fluffed up; they are not dried completely. - Remove the garments immediately after the end of the programme. 	
Denim		Max. load 3.0 kg*
Normal plus, Normal, Hand iron, Timed drying¹		
Items	All denim garments, e.g. jeans, jackets, skirts, shirts	

Freshen up		Max. load 1.0 kg*
Normal, Hand iron, Timed drying¹		
Items	Clean dry garments and garments that have been worn briefly and are not soiled	
Tip	<p>The laundry is dampened before the programme starts to help reduce creasing.</p> <ul style="list-style-type: none"> - Normal: for garments that are required immediately. - Hand iron: for garments that are to be ironed or hung out to dry completely on a coat hanger. 	
Note	Creasing increases the larger the load and the longer the drying time.	
Steam care		Max. load 2.0 kg*
Hand iron		
Items	<p>Reduces the amount of creasing in damp, freshly washed and spun cotton or linen garments</p> <p>The garments must be suitable for drying in a tumble dryer   and suitable for ironing  .</p>	
Tip	Remove garments immediately after the end of the programme and hang them up on a coat hanger.	
Note	Not suitable for garments made of wool or wool blend fabric.	
Outerwear		Max. load 2.5 kg*
Normal plus, Normal, Hand iron, Timed drying¹		
Items	Outdoor clothing which is suitable for tumble drying	
Proofing		Max. load 2.5 kg*
Normal		
Items	For thermally fixing textiles which are suitable for tumble drying and have been treated with a proofing agent	
Express 20		Max. load 3.5 kg*
Normal plus, Normal, Hand iron, Timed drying¹		
Items	Items suitable for the Cottons programme	
Note	The programme running time for this programme is particularly short when washing and drying lightly soiled laundry in a continuous sequence.	



DRYING

Sportswear		Max. load 2.5 kg*
Normal plus, Normal, Hand iron, Timed drying¹		
Items	Sportswear which is suitable for drying in a tumble dryer	
Dark garments		Max. load 3.0 kg*
Normal plus, Normal, Hand iron, Timed drying¹		
Items	Black and dark items made from cotton or mixed fibres	
Trainers		Max. 2 pairs
Timed drying¹		
Items	Trainers that are specified as suitable for tumble drying by their manufacturer	
Tip	Insoles should be removed and placed in the drum with the shoes.	
Note	The drum does not rotate.	
Silks		Max. load 1.0 kg*
8 minutes		
Items	Silk garments which are suitable for drying in the tumble dryer, e.g. blouses and shirts	
Tip	<ul style="list-style-type: none"> - For reduced creasing. - Items are not dried completely. - Remove the garments immediately after the end of the programme. 	
Down filled items		Max. load 2.0 kg*
Timed drying¹		
Items	Jackets, sleeping bags and other down-filled items that are suitable for tumble drying	
Tip	Check the items as you are drying them to find the optimum time.	
Pillows		2 pillows (40 x 80 cm) or 1 pillow (80 x 80 cm)
Timed drying¹		
Items	Pillows with synthetic filling that are suitable for tumble drying	
Tip	Pillows can still feel damp after being dried. You can use this programme several times until the pillow feels dry.	

DRYING

Cottons hygiene		Max. load 5.0 kg*
Normal		
Items	Cottons and linen fabrics, which are in direct contact with the skin, e.g. underwear, nappies, bed linen	
Note	The laundry will feel drier because of the longer temperature holding time.	
Automatic plus		Max. load 3.0 kg*
Normal plus, Normal, Hand iron, Timed drying¹		
Items	Mixed loads of garments suitable for the <i>Cottons</i> and <i>Minimum iron</i> programmes	
First wash		Max. load 2.0 kg*
Normal plus, Normal, Hand iron, Timed drying¹		
Textiles	New cotton, towelling or polyester textiles	
Warm air		Max. load 4.0 kg*
Timed drying¹		
Items	<ul style="list-style-type: none"> - Additional drying for multi-layered items whose layers have different drying characteristics, e.g. jackets, pillows, sleeping bags - For drying and airing individual items 	
Tip	Do not select the longest drying time to start with. Check the items as you are drying them to find the optimum time.	
Cool air		Max. load 4.0 kg*
Timed drying¹		
Items	Any items which only need airing	

DRYING

Cottons 		Max. load 5.0 kg*
Normal		
Items	Cotton items such as those described under <i>Cottons Normal</i> with normal residual moisture	
Tip	- The Cottons  programme is the most energy-efficient for drying cotton items with normal residual moisture levels.	
Note for test institutes: the Cottons  programme is the test programme in accordance with Regulation 392/2012/EU for energy labelling, measured in accordance with EN 61121.		

¹ Timed drying

Timed drying is particularly suitable for small loads or when you want to dry individual items. The items are dried with warm air (a drying time between 20 minutes and 2 hours can be selected). The drying temperature is adjusted to match the programme selected. Do not select the longest drying time to start with. Check the items as you are drying them to find the optimum time.

Thermospin

A thermospin is carried out in some drying programmes to reduce energy consumption.

Thermospin is not carried out if timed drying is selected.

The maximum spin speed for the thermospin is the maximum permitted spin speed for the appropriate wash programme.





The thermospin spin speed can be reduced to 800 rpm.

Extras

You can select extra options to augment drying programmes.

Pre-ironing

In order to reduce creasing, the laundry undergoes a smoothing process at the end of the programme. The spin speed for the thermospin is reduced. Reducing the maximum load size by 50 % will achieve a better result.

The garments must be suitable for drying in a tumble dryer   and suitable for ironing  .

SingleDry

For efficiently drying a very small load size (< 1 kg) in a normal drying programme.

A drying time is preset. You can change the drying time.

Some items may still be damp after drying, depending on the type of laundry. Select a longer duration next time.

Gentle tumble

Delicate textiles such as acrylics are dried gently (care label symbol .

In some programmes the programme running time will increase when *Gentle tumble* is selected because of the lower temperature.

Extra quiet

If you want to dry clothes in quiet periods, the noise level of the washer-dryer can be reduced.

- The buzzer is deactivated.
- Thermospin is limited to a maximum of 800 rpm.

WASHING AND DRYING

Washing and drying in one continuous sequence

It is advisable to wash and dry in a continuous sequence when the amount of laundry to be washed does not exceed the amount to be dried and the amount to be dried does not exceed the permitted dry weight for the programme.

It is very important to read the sections “Separate washing” and “Separate drying” before proceeding.

1. Prepare the laundry

- Empty all pockets.
- Sort the laundry according to colour and type of fibre/weave.
- Check the symbols on the care labels.

2. Selecting a programme

- Touch the *Washing + Drying* sensor control.
- Scroll to the right in the display until the programme you want appears.
- Touch the sensor control for that programme.

The display will then change to the standard menu for the programme.

There are 3 other ways to select a programme:

- Saved favourite programmes
- The washing/drying assistant
- Miele MobileStart

3. Load the drum

- Open the door.

Check the drum for pets or foreign objects before loading it with laundry.

- Unfold the laundry and load loosely into the drum.

Detergent dispensing aids, e.g. plastic dispenser balls, can melt during the drying programme and cause damage to the machine and the laundry.

These dispensing aids must be removed from laundry before drying.

- Close the door.

4. Selecting programme settings

- Select the desired temperature, spin speed and drying level and confirm each with *OK*.

The minimum spin speed cannot be lower than 800 rpm.
For some programmes the spin speed cannot be changed.

To prevent laundry forming a ring against the drum wall, the spin speed is limited to a maximum of 1200 rpm when washing and drying in a continuous sequence.

- Select *TwinDos* or *CapDosing* if desired.
- Select further options or stains as required.

With the *thermospin*, the spin speed displayed for the wash cycle is used. If *Extra quiet* is selected the maximum spin speed used is 900 rpm.

Thermospin is not carried out if timed drying is selected.

- Select a delay start time if required.

5. Adding detergent

- Dispense detergent with *TwinDos*, *CapDosing* or via the detergent drawer.

6. Starting/ending the programme

- Touch the flashing *Start/Stop* sensor control.

The door is locked.

The programme will start.

The anti-crease phase will start at the end of the programme.

The door remains locked during the anti-crease phase.

- Press the *Start/Stop* button.

The door will unlock.

If you unload the laundry during the anti-crease phase, heat can build up. Spread the laundry out to cool it down.

The door unlocks automatically at the end of the anti-crease phase.

- Pull the door open and unload the laundry.

See "After each washing or drying programme".

After each washing or drying programme

- Open the door **fully**.

 Risk of burning due to hot metal. The metal cap located on the inside of the door glass will be hot after drying. Do not touch the metal cap.

Use the **Rinse out fluff** programme to prevent fluff from collecting in the drum and suds container, particularly after drying.

- Remove the laundry.

Laundry left in the drum could shrink, discolour or be damaged in the next washing or drying programme. Check that all items have been removed from the drum.

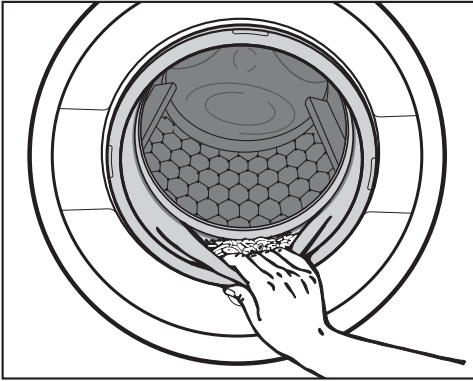

- Check the door sealing ring for any foreign objects.
- After drying, remove any fluff from around the door sealing ring and the porthole glass.

Tip: Leave the door slightly open to allow the drum to dry.

- Switch the washer-dryer off with the  button.

Tip: Leave the detergent drawer slightly open to allow it to dry.

Changing the programme sequence

Changing a programme (safety lock)

A programme, temperature, spin speed or selected options cannot be changed once the machine has been successfully started. This prevents the machine being operated unintentionally, e.g. by children.

If the washer-dryer is switched off during active programme operation, the standby function does not switch the washer-dryer off completely after 15 minutes. Safety functions continue to be active because there may still be water inside the drum.

Cancelling a programme

You can cancel a programme at any time after it has started.

- Touch the *Start/Stop* sensor control.

The following will appear in the display:

 Cancel the programme?

- Select Yes.

- During washing:

The washer-dryer pumps the suds away and the programme is cancelled.

- During drying:

The washer-dryer cools the laundry down before the door can be opened.

Removing the laundry



- Wait until the  symbol in the display goes out and the door is unlocked.
- Pull the door open and unload the laundry.

Selecting another programme

- Close the door.
- Select the programme you want to use.
- Add detergent to the detergent drawer, if necessary.
- Press the *Start/Stop* button.

The programme will start.

Interrupting a programme

- Switch the washer-dryer off with the  button.
- To continue the programme, switch the washer-dryer back on with the  button.

 Danger of overheating due to hot laundry

Hot laundry can ignite.

Never switch the washer-dryer off during a drying programme.

If you absolutely must interrupt the programme, remove all items immediately and spread them out to cool down.

Favourite programmes

Creating favourites

You can save your own customised wash programmes under names of your choice.

Option 1

- Scroll through the main menu until Favourites appears.

- Touch the Favourites sensor control.

The display will change to the Favourites menu.

Touch the Create sensor control.

The display will change to the Create Favourites menu.

- Select Washing, Drying or Washing + Drying.

- Select the programme you want to use.

- Select all the programme settings you want.

- Then select Save.

- Enter a name.

Option 2

You can save a programme which has been selected as a Favourite programme before you start it.

- Before the programme starts, touch the Save sensor control.

- Enter a name.

If 12 Favourites have already been saved, the Create or Save sensor control will not be visible. Delete an existing Favourite if you wish to create a new one.

Entering a name

It is best to select short, memorable names.

- Touch the desired letters or characters.

- Confirm with the Save sensor control.

The wash programme will then be saved to the Favourites programme list.

To change a Favourite programme

You can rename, delete or move a Favourite programme.

- Select the Favourites sensor control from the main menu.

- Touch the Favourite programme that you wish to change until the context menu opens.

- Select Rename, Delete or Move.

Washing/drying assistant

The assistant helps you with washing and drying loads consisting of items with different care labels. The washing machine will use the list of items to put together a suitable programme.

- Scroll through the main menu until Wash/Drying assistant appears.
- Touch the Wash/Drying assistant sensor control.

The display will change to the Purpose menu.

- Select a goal, e.g. Washing or Washing + Drying.

A list of items will appear.

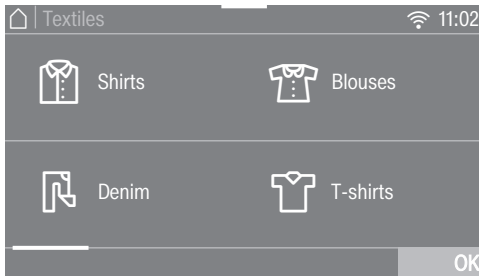

- Touch the appropriate sensor control for your item of laundry.

The item selected will be highlighted orange.

You can select several items. Articles that cannot be combined are not available for selection.

- Confirm with the OK sensor control.
- Follow the instructions in the display.

A summary of the selected parameters will then appear in the display.

- Confirm with the OK sensor control or select Change if you would like to make any changes.

The programme which has been tailored to your laundry is ready to start.

Helpful tips are sometimes displayed before the start of the programme.

Tip: You can add individual programme settings, e.g. Extras, before you start the programme.

Timer/SmartStart

Timer



The timer can be used to set the time you wish a programme to finish or start at. The programme start can be delayed by up to 24 hours.

Setting the timer

- Touch the  Timer sensor control.
- Select the Finish at or Start at option.
- Set the hours and the minutes and confirm with the *OK* sensor control.



Changing the delay start time

The selected timer can be changed before the programme starts.

- Touch the  or  sensor control.
- If required, change the specified time and confirm with the *OK* sensor control.

Deleting the timer

The selected timer can be deleted before the programme starts.

- Touch the  or  sensor control.

The selected time for the timer appears in the display.

- Touch the *Delete* sensor control.
- Confirm with the *OK* sensor control.

The selected time for the timer is now deleted.

Starting the timer

- Touch the *Start/Stop* sensor control.

The door will lock and the time until the programme starts will appear in the display.

After the programme has started, the selected time for the timer can only be changed or cancelled by interrupting the programme.

The programme can be started immediately at any time.

- Touch the *Start immediately* sensor control.

SmartStart

The SmartStart function lets you define a time period during which your washer-dryer will start automatically. The appliance will start on receipt of a signal, e.g. from your energy supplier, that indicates that the electricity tariff is particularly economical.

This function is active when the SmartGrid setting is switched on.

The timeframe can be defined between 1 minute and 24 hours. During this period, the washer-dryer waits for the signal from the energy supplier. If no signal is sent during the defined period, the washer-dryer starts the programme.

Setting the time period

If you have activated SmartGrid in the settings, SmartStart by and SmartFinish by will appear in the display instead of Start at and Finish at when you touch the ⌚ Timer sensor control. See “Settings” – “SmartGrid” for more information.

The procedure for setting this is the same as for setting the time for the timer.

- Set the time you want and confirm with the OK sensor control.
- Touch the *Start/Stop* sensor control to start the wash programme with SmartStart.

The selected programme will start automatically, as soon as the energy supplier has sent the signal, or the latest calculated start time has been reached.

The procedure for changing or deleting the *SmartStart* function is the same as described in “Changing the timer” and “Deleting the timer”.

Cleaning and care

Starting maintenance programmes

The washer-dryer has 3 maintenance programmes.

- Scroll through the main menu until Maintenance appears.
- Touch the Maintenance sensor control.

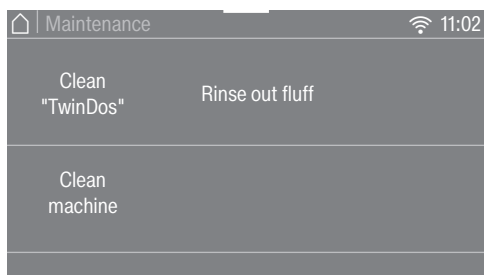

Clean "TwinDos"

Clean "TwinDos" is a programme for cleaning the TwinDos system. The programme cleans the hoses inside the washer-dryer.

 Damage resulting from dried laundry detergent.

If the system has not been used for a long time (more than 2 months), detergent in the hoses can become viscous or dry out. The hoses can become blocked and would then need to be cleaned by the Customer Service Department.

Clean the TwinDos system.

To clean the system, you need either a "TwinDos Care" cleaning cartridge or a TwinDos refill container, available from www.shop.miele.com.

Starting the programme

- Select Clean "TwinDos".
- Touch the sensor control for the container you want to clean.
- Confirm Start Maintenance programme? with the Yes sensor control.
- Follow the instructions in the display.

This cleans the hoses. The TwinDos system can then be used again at any time.

Cleaning the compartment

Detergent residue can cause clogging.

- Use a damp cloth to clean the compartment interior when you change the cartridge or container.

Clean machine

With frequent washing at low temperatures there is a danger of a build-up of bacteria in the washer-dryer.

Cleaning the washer-dryer will significantly reduce bacteria, mould and biofilm and prevent the build-up of unpleasant odours.

Start the **Clean machine** programme at the latest when the *Hygiene info* message appears in the display.

Tip: Optimum results can be achieved by using Miele machine cleaner. Alternatively, a multi-purpose detergent can be used.

Starting the programme

- Select **Clean machine**.
- Dispense the washing machine cleaner or multi-purpose detergent directly in the drum.
- Do **not** load any laundry. The drum must be empty for the cleaning process.
- Touch the **Start/Stop** sensor control.

The programme will start.

Rinse out fluff

During drying, fluff develops and can collect in the drum and suds container. You can rinse out fluff before the machine is used again so that this fluff (e.g. from dark coloured textiles) cannot be deposited on other items (e.g. light coloured textiles) in the next load or cause a blockage in the washer-dryer.

The *Rinse out fluff programme* must not be used for rinsing laundry. Ensure there are no items of laundry in the drum before starting the programme.

Starting the programme

- Select **Rinse out fluff**.

Do not use detergent.

- Touch the **Start/Stop** sensor.

Any fluff will be rinsed away within a few minutes.

- If necessary wipe any remaining fluff off the door sealing ring and door glass.
- Switch the washer-dryer off.

Cleaning and care

Cleaning the casing and control panel

⚠ Risk of electric shock from mains voltage.

The mains voltage is applied to the washer-dryer even if it is switched off.

Disconnect the power plug before cleaning or maintenance.

⚠ Risk of damage due to ingress of water.

The pressure of a water jet can cause water to get into the washer-dryer, resulting in damage to components.

Do not spray the washer-dryer with a water jet.

⚠ Damage caused by cleaning agents.

Solvent-based cleaning agents, abrasive cleaners, glass cleaners or multi-purpose cleaning agents can cause damage to plastic surfaces and other parts.

Do not use these cleaning agents.

- Clean the casing and control panel with a mild cleaning agent or soap and water and dry both with a soft cloth.
- The drum can be cleaned using a suitable stainless steel cleaning agent.

Cleaning the detergent dispenser drawer

Washing at low temperatures and the use of liquid detergent can lead to a build-up of mould and bacteria in the detergent dispenser drawer.

- Clean the entire drawer at regular intervals for hygiene reasons, even if you are using the TwinDos system exclusively.

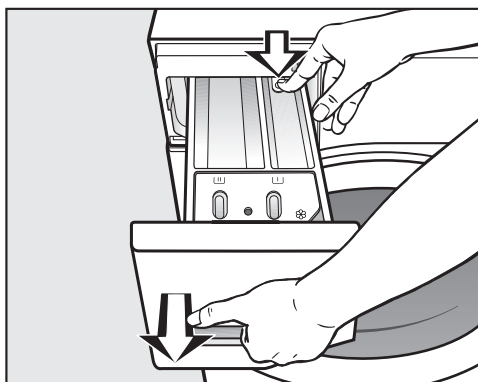

- Pull out the detergent dispenser drawer until a resistance is felt. Press down the release button and at the same time pull the drawer right out of the machine.
- Clean the drawer with hot water.

Cleaning the siphon and the channel

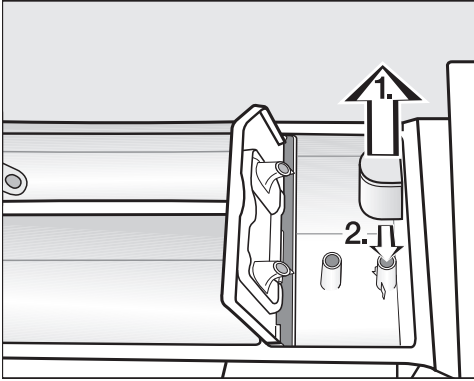

- Pull the siphon out of the compartment and clean it under warm running water.
- Clean the siphon tube in the same way.
- Refit the siphon.

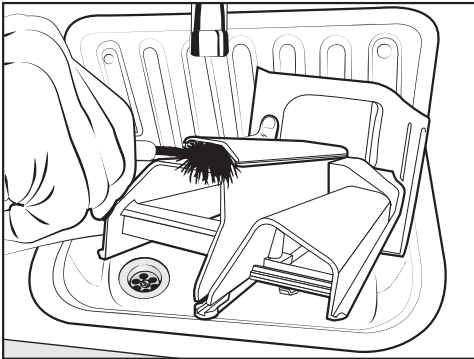

- Clean the fabric conditioner channel using a brush and warm water.

Liquid starch results in clogging. Clean the siphon particularly thoroughly after using liquid starch a few times.

Cleaning the detergent dispenser drawer housing

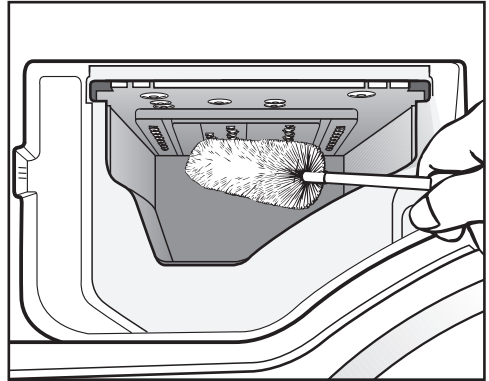

- Use a bottle brush to remove detergent residues and limescale from the jets inside the detergent dispenser drawer housing.
- Replace the detergent dispenser drawer.

Tip: Leave the detergent dispenser drawer slightly open to allow it to dry.

Cleaning the porthole glass

- Clean the inside of the porthole glass from time to time and the metal cap inside the porthole glass with a suitable mild cleaning agent or with soapy water.
- Dry both with a soft cloth.

Cleaning and care

Cleaning the water intake filter

The washer-dryer has a filter to protect the water intake valve. The filter at the open end of the water inlet hose should be checked approximately every 6 months. Perform this check more often if there are frequent interruptions to the external water supply.

- First turn off the stopcock.
- Unscrew the water inlet hose from the stopcock.

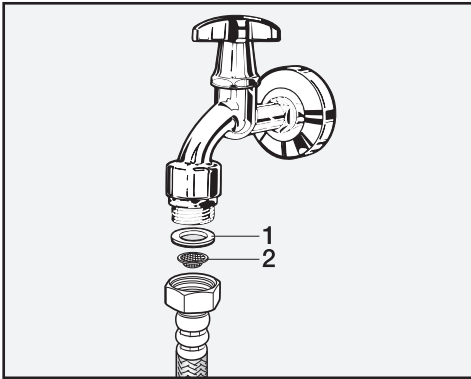



- Remove the rubber seal **1** from the recess.
- Hold the free end of the water inlet hose upside down. The plastic filter **2** will fall out.
- Clean the plastic filter.
- Reassemble in reverse order.
- Turn on the stopcock and check that the connection is watertight. If water drips out, tighten the connection.

Never forget to put the filter back in place after cleaning.

Many malfunctions and faults that can occur in daily operation can be easily remedied. Time and money will be saved because a service call will not be needed.





The following guide may help you to find the reason for a malfunction or a fault, and to correct it.

A programme does not start

Problem	Cause and remedy
<p>The display remains dark and the  button indicator light does not come on.</p>	<p>There is no power to the washer-dryer.</p> <ul style="list-style-type: none"> ■ Check whether the power plug is plugged in. ■ Check whether the fuse has tripped. <hr/> <p>The washer-dryer has switched off automatically to save energy.</p> <ul style="list-style-type: none"> ■ Switch the washer-dryer on with the  button.
<p>The display prompts you to enter a code.</p>	<p>Access via a code has been activated.</p> <ul style="list-style-type: none"> ■ Enter the code and confirm the entry. Deactivate the code if you do not wish this message to appear in the display the next time the machine is switched on.
<p>The following appears in the display:  The door will not lock. Call Service.</p>	<p>The door is not closed properly. The door lock could not engage.</p> <ul style="list-style-type: none"> ■ Close the door again. ■ Start the programme again. ■ If the fault message appears again, contact the Miele Customer Service Department.

Problem solving guide

Fault message after a programme has been interrupted.

Problem	Cause and remedy
 Water intake fault. Open the stopcock.	The water inlet is blocked or restricted. <ul style="list-style-type: none">■ Check whether the stopcock has been properly opened.■ Check whether the water inlet hose is kinked.■ Check whether there is sufficient water pressure.
	The filter in the water inlet is blocked. <ul style="list-style-type: none">■ Clean the filter.
 Drainage fault. Clean drain filter and pump. Check the drain hose.	The drain is blocked or restricted. The drain hose has been fixed too high. <ul style="list-style-type: none">■ Clean the drain filter and the drain pump.■ Check whether the maximum delivery head of 1 m has been exceeded.
 Waterproof system activated. Close stopcock and call Service	The water protection system has reacted. <ul style="list-style-type: none">■ Close the stopcock.■ Call the Miele Customer Service Department.
 Fault F. If restart fails, call Service.	There is a fault. <ul style="list-style-type: none">■ Disconnect the washer-dryer from the electricity supply. Switch off at the wall and withdraw the plug from the socket, or disconnect the fuse.■ Wait at least 2 minutes before reconnecting the washer-dryer to the electricity supply.■ Switch the washer-dryer back on.■ Restart the programme.■ If the fault message appears again, contact the Miele Customer Service Department.

To switch off the fault message, switch the washer-dryer off with the  button.

Fault message at the end of a programme

Message	Cause and remedy
i Intensive flow: Clean the filter and jet or remove foreign objects from the pump housing.	The pumps are soiled. <ul style="list-style-type: none"> ■ Clean the pumps as described in the “Problem solving guide” – “Opening the door in the event of a blocked drain outlet and/or power cut”. ■ Start a wash programme again after cleaning.
	The nozzle in the top of the door sealing ring is blocked with fluff. <ul style="list-style-type: none"> ■ Remove the fluff with your finger. Do not use any sharp or pointed tools to do this. ■ Start a wash programme again after cleaning.
	If the fault message appears again, contact the Miele Customer Service Department. The washer-dryer can still be used but with reduced functionality.
i Check load	There is no laundry in the drum.
	The load is too small. The laundry is still damp because the residual moisture content in the laundry cannot be measured. <ul style="list-style-type: none"> ■ In the future use a <i>Timed drying</i> programme for small amounts of laundry.
	The amount of laundry exceeded the maximum load for the selected programme. <ul style="list-style-type: none"> ■ Observe the maximum load sizes given in the Programme chart.
i Start "Rinse out fluff" programme in the "Maintenance" menu	The <i>Rinse out fluff</i> programme has not been used for a long time. <ul style="list-style-type: none"> ■ Start the <i>Rinse out fluff</i> programme as described in “Cleaning and care” – “Starting maintenance programmes”.

To switch off the fault message, switch the washer-dryer off with the  button.

Problem solving guide

Fault message at the end of a programme

Message	Cause and remedy
i Align the machine. Laundry not properly spun	<p>The smoothing process which the laundry undergoes at the end of the programme could not be carried out properly.</p> <ul style="list-style-type: none">■ Check whether the washer-dryer is aligned correctly as described in “Installation” – “Levelling the machine”.■ Check whether the maximum delivery head of 1.0 m has been exceeded. <p>If the fault message appears again, contact the Miele Customer Service Department. The washer-dryer can still be used but with reduced functionality.</p>
i Hygiene info: select "Maintenance" and run the "Clean machine" programme.	<p>No drying or wash programme using a temperature above 60 °C has been run for a long time.</p> <ul style="list-style-type: none">■ In order to prevent bacteria and unpleasant odours building up in the machine, run the <i>Clean machine</i> programme using the Miele dishwasher and washing machine cleaner or powder detergent.

To switch off the fault message, switch the washer-dryer off with the  button.

Problems with TwinDos

Problem	Cause and remedy
<p>i Fit a new cartridge or fill container ①</p>	<p>The cartridge is empty.</p> <ul style="list-style-type: none"> ■ Replace the cartridge. ■ Check whether the laundry is clean. There may not have been enough detergent. Wash the laundry again if necessary.
<p>i Only a few more washes are possible before a new cartridge is needed for compartment ①.</p>	<p>The detergent in the cartridge is running low. There is sufficient left for approx. 4 to 8 wash programmes.</p> <ul style="list-style-type: none"> ■ Order a new cartridge.
<p>i Use "TwinDos" or carry out "TwinDos" Maintenance in the "Maintenance" menu. See the operating instruction manual for more information.</p>	<p>TwinDos has not been used for a long time.</p> <ul style="list-style-type: none"> ■ Use TwinDos for one of your next loads. ■ Carry out the TwinDos maintenance programme as described in "Cleaning and care" – "Starting maintenance programmes".
<p> "TwinDos" Maintenance for compartment ① must be started in the "Maintenance" menu. See the operating instruction manual for more information.</p>	<p>TwinDos has not been used for too long a time. The detergent in the hoses may dry up.</p> <ul style="list-style-type: none"> ■ Carry out the TwinDos maintenance programme immediately as described in "Cleaning and care" – "Starting maintenance programmes".
<p>The messages shown on this page are examples. They may differ depending on whether they refer to compartment ① or ②.</p>	

The messages will appear at the end of the programme and when the washer-dryer is switched on and need to be confirmed with the OK sensor.

Problem solving guide

Problems with TwinDos



Problem	Cause and remedy
There are dark specks in the liquid detergent.	Mould has developed in the detergent. <ul style="list-style-type: none">■ Pour the liquid detergent out of the container and then clean the container thoroughly.
No detergent and/or fabric conditioner was dispensed.	Automatic dispensing has not been activated. <ul style="list-style-type: none">■ Touch the <i>TwinDos</i> sensor before running the next programme. Automatic dispensing will be activated.
	No detergent/fabric conditioner was dispensed even though automatic dispensing was activated. <ul style="list-style-type: none">■ Try again.■ If detergent is still not dispensed, call the Service Department.
A new detergent cartridge has been inserted, but the cartridge is identified as empty when the machine is switched on.	The washer-dryer was switched off when the detergent cartridge was replaced. <ul style="list-style-type: none">■ Switch the washer-dryer on.■ Remove the detergent cartridge and then reinsert it into the compartment. The counter is set to 0.

General problems with the washer-dryer

Problem	Cause and remedy
The washer-dryer is not steady during a spin cycle.	<p>The machine feet are not level.</p> <ul style="list-style-type: none"> ■ Level the washer-dryer and secure the feet.
Unusual pumping noises.	<p>This is not a fault. These slurping noises occur at the end of the pump sequence as a normal part of operation.</p>
Spinning sounds during the drying process.	<p>This is not a fault. The machine will spin, even during a drying programme (thermospin).</p>
The laundry has not been spun properly and the laundry is still wet.	<p>The machine detected an imbalance during the final spin cycle and reduced the spin speed automatically.</p> <ul style="list-style-type: none"> ■ Include both large and small items in the load as this will give better distribution during spinning.
Large amounts of detergent residue remain in the detergent drawer.	<p>The water flow pressure is too low.</p> <ul style="list-style-type: none"> ■ Clean the filters in the water inlet. ■ Select <i>Water plus</i>.
	<p>Powder detergent used in conjunction with water softeners tends to become sticky.</p> <ul style="list-style-type: none"> ■ Clean the detergent drawer and, in the future, add washing powder in the compartment first, and then add the water softener.
There is water in the fabric conditioner compartment next to the capsule.	<p>CapDosing was not activated or an empty capsule was not removed at the end of the last wash programme.</p> <ul style="list-style-type: none"> ■ Make sure that you remember to activate CapDosing the next time you insert a capsule. ■ Remove and dispose of the empty capsule at the end of each programme.
	<p>There is a blockage in the small pipe in the detergent drawer onto which the capsule is placed.</p> <ul style="list-style-type: none"> ■ Clean the small pipe.

Problem solving guide

General problems with the washer-dryer

Problem	Cause and remedy
Fabric conditioner is not completely dispensed or too much water remains in the  compartment.	The siphon tube is not correctly positioned or is clogged. <ul style="list-style-type: none">■ Clean the siphon, see “Cleaning and care - Cleaning the detergent dispenser drawer”.
At the end of the programme there is still liquid in the capsule.	The small pipe in the detergent dispenser drawer onto which the capsule is placed is blocked. <ul style="list-style-type: none">■ Clean the small pipe.
	This is not a fault. For technical reasons a small amount of water will remain in the capsule.
The display is in a different language.	A different language has been selected in “Settings” “Language  <p>90</p>

General problems with the washer-dryer

Problem	Cause and remedy
<p>Foam comes out of the detergent dispenser drawer while the <i>Rinse out fluff</i> programme is running.</p>	<p>Residual detergent from the last programme is still present in the suds container.</p> <ul style="list-style-type: none"> ■ Always dispense the correct amount of detergent. Where possible select automatic dispensing.
<p>There is foam in the drum at the end of the <i>Rinse out fluff</i> programme.</p>	<p>The <i>Rinse out fluff programme</i> also rinses out residual detergent from the suds container. This can lead to the formation of foam.</p> <ul style="list-style-type: none"> ■ Run the <i>Rinse out fluff programme</i> regularly to prevent detergent residues from accumulating in the suds container.
<p>There is still fluff in the drum after the end of the <i>Rinse out fluff</i> programme.</p>	<p>You have not run the <i>Rinse out fluff programme</i> for a long time.</p> <ul style="list-style-type: none"> ■ Remove the fluff from the drum. ■ Run the <i>Rinse out fluff programme</i> on a regular basis.
<p>The washer-dryer smells.</p>	<p>Hygiene info was ignored. A wash programme using a temperature above 60 °C has not been run for a long time.</p> <ul style="list-style-type: none"> ■ In order to prevent bacteria and unpleasant odours building up in the machine, run the <i>Clean machine</i> programme using the Miele dishwasher and washing machine cleaner or powder detergent.
	<p>The door and the detergent dispenser drawer were left open after washing.</p> <ul style="list-style-type: none"> ■ Leave the door and the detergent dispenser drawer slightly open to allow them to dry.

Problem solving guide

An unsatisfactory wash result

Problem	Cause and remedy
White residues which look like powder detergent are seen on dark textiles after washing.	<p>The detergent contained compounds (zeolites) to aid water softening which are not soluble in water. These have ended up on the laundry.</p> <ul style="list-style-type: none">■ Try and brush off the residues with a soft brush once the laundry is dry.■ Wash dark textiles using a detergent which contains no zeolites. Liquid detergents usually contain no zeolites.■ Use the <i>Dark garments</i> programme.
Liquid detergent does not give the required result.	<p>Liquid detergents usually contain no bleaching agents. They do not remove fruit, coffee and tea stains.</p> <ul style="list-style-type: none">■ Use the Miele 2 Phase System. The targeted addition of UltraPhase 2 during the wash process removes stains effectively.■ Use a general purpose powder detergent containing a bleaching agent.
Grey, greasy particles cling to washed laundry.	<p>Insufficient amounts of detergent were used to break down the particles of grease in heavily soiled laundry.</p> <ul style="list-style-type: none">■ Use more detergent.■ Before washing the next load, run the <i>Maintenance wash</i> using Miele machine cleaner or a powder detergent.

Unsatisfactory drying results

Problem	Cause and remedy
<p>The laundry is too damp after drying and appears in the display. Check load</p>	<p>The load is too small. The electronics could not assess the residual moisture correctly.</p> <ul style="list-style-type: none"> ■ Start the programme again and instead of a drying level select a <i>Timed drying</i> programme. ■ In the future use a <i>Timed drying</i> programme for small amounts of laundry. <p>During the spin cycle, the laundry formed a ring in the drum because the laundry was distributed unevenly.</p> <p>The laundry formed a ring during the thermospin because it was too damp or because the spin speed was set too high.</p> <ul style="list-style-type: none"> ■ Open the door and loosen the laundry. ■ Start the drying programme again with a lower spin speed, or select <i>Timed drying</i> instead of a drying level.
<p>The laundry feels damp after drying.</p>	<p>The <i>Pre-ironing Extra</i> was selected.</p> <ul style="list-style-type: none"> ■ Unload the laundry and place it on hangers to finish drying. <p>Warm laundry can feel damp.</p> <ul style="list-style-type: none"> ■ Spread the laundry out to cool it down.
<p>The laundry is too damp or too dry after a drying cycle.</p>	<p>The desired residual moisture level is between two drying stages.</p> <ul style="list-style-type: none"> ■ Change the level of drying as described in “Settings”, “Drying levels”.
<p>There is still water in the drum after drying.</p>	<p>There is a blockage in the water outlet.</p> <ul style="list-style-type: none"> ■ Clean the drain filters and the drain pumps as described in “Opening the door in the event of a blocked drain outlet and/or power failure” and check the height of the drainage point.

Problem solving guide

The door will not open

Problem	Cause and remedy
The door cannot be opened during a programme sequence.	The door is locked during a programme sequence. ■ Follow the instructions in “Washing” – “6. Starting the programme”.
	There is still water in the drum and the washer-dryer is unable to drain. ■ Clean the drain filters and the drain pump as described in “Opening the door in the event of a blocked drain outlet and/or power failure”.
	The water level in the drum is too high. ■ Cancel the programme. The washer-dryer will pump the water away.
At the end of the programme or after a programme cancellation: Comfort cooling appears in the display.	For safety reasons the door cannot be opened if the temperature in the drum exceeds 55 °C during washing or 70 °C during drying. ■ Wait until the temperature in the drum has decreased and the message has gone out in the display.
The following appears in the display: The door lock is jammed. Call Service.	The door lock has jammed. ■ Call the Miele Customer Service Department.

Opening the door in the event of a blocked drain outlet and/or power cut

- Switch the washer-dryer off.

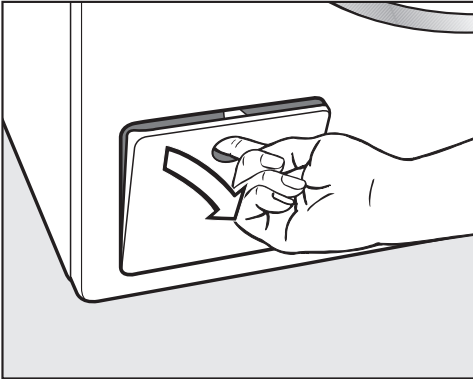

- Open the drain pump access panel.

Blocked drain outlet

If the drain outlet is blocked, a large quantity of water can remain in the washer-dryer.

 Risk of scalding due to hot suds. Escaping suds will be hot if laundry has been washed at high temperatures. Carefully allow all suds to drain off.

Draining the washing machine

Remove the drain filter, though not completely.

- Place a suitable container under the access panel, e.g. a universal oven tray.

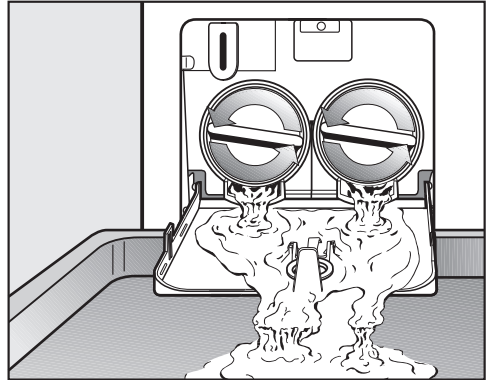

- Slowly unscrew the drain filters to let the water out.
- Tighten the drain filters back up again if you need to interrupt the flow of water.

Once the flow of water ceases:

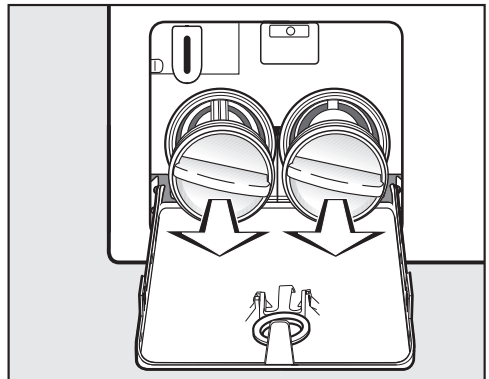

- Remove the drain filters completely.

Problem solving guide

Cleaning the drain filters

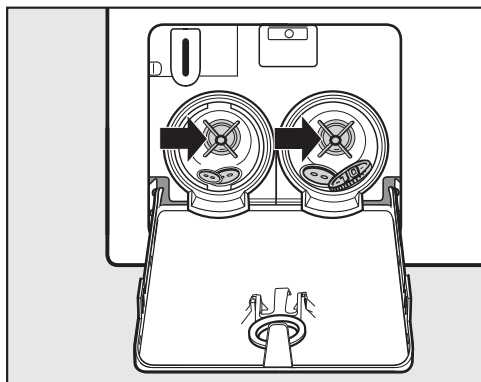

- Clean the drain filters thoroughly.
- Remove any foreign objects (e.g. buttons, coins) and clean the interior. Turn the impellers by hand to check that they rotate freely.

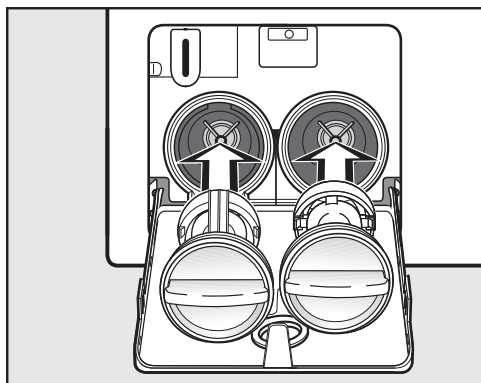

- Replace the drain filters correctly (on the right and left) and tighten them securely.

⚠ Risk of damage from leaking water.

Water will escape from the washer-dryer if you forget to replace the drain filters.

Replace the drain filters correctly and tighten them securely.

Opening the door

⚠ Danger of injury due to rotating drum.

Reaching into a moving drum is extremely dangerous.

Always make sure that the drum is stationary before reaching in to remove laundry.

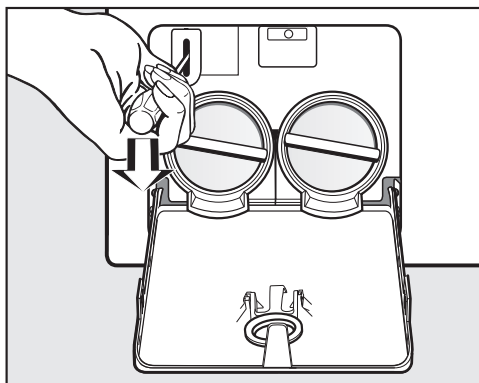

- Use a screwdriver to unlock the door.
- Pull open the door.

Contact in the event of a fault

In the event of any faults which you cannot remedy yourself, please contact your Miele dealer or the Miele Customer Service Department.

You can book a Miele Customer Service Department call-out online at www.miele.com/service.

Contact information for the Miele Customer Service Department can be found at the end of this document.

Please quote the model identifier and serial number of your appliance (Fabr./SN/Nr.) when contacting the Miele Customer Service Department. This information can be found on the data plate.

Please note that telephone calls may be monitored and recorded for training purposes and that a call-out charge will be applied to service visits where the problem could have been resolved as described in this booklet.

The data plate is found above the porthole glass when the door is opened.

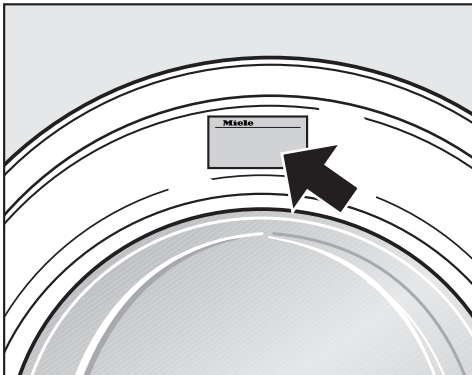

Warranty

For information on the appliance warranty specific to your country please contact Miele. See back cover for address.

In the UK, your appliance warranty is valid for 2 years from the date of purchase. However, you must activate your cover by calling 0330 160 6640 or registering online at www.miele.co.uk.

Optional accessories

Optional accessories for this washer-dryer are available from Miele or your Miele dealer.

EPREL database

From 1 March 2021, information on energy labelling and ecodesign requirements will be available in the European Product Database (EPREL). You can find the product database at the following link <https://eprel.ec.europa.eu/>. You will be asked to enter the model identifier.

The model identifier can be found on the data plate.

Miele Made in xxx

Mod.: XXXxxx

M-Nr.: xxxxxxxx Type: XXxx-X

Nr.:/ xxxxxxxxx

Miele Service
www.miele.com/service

Installation

Front view

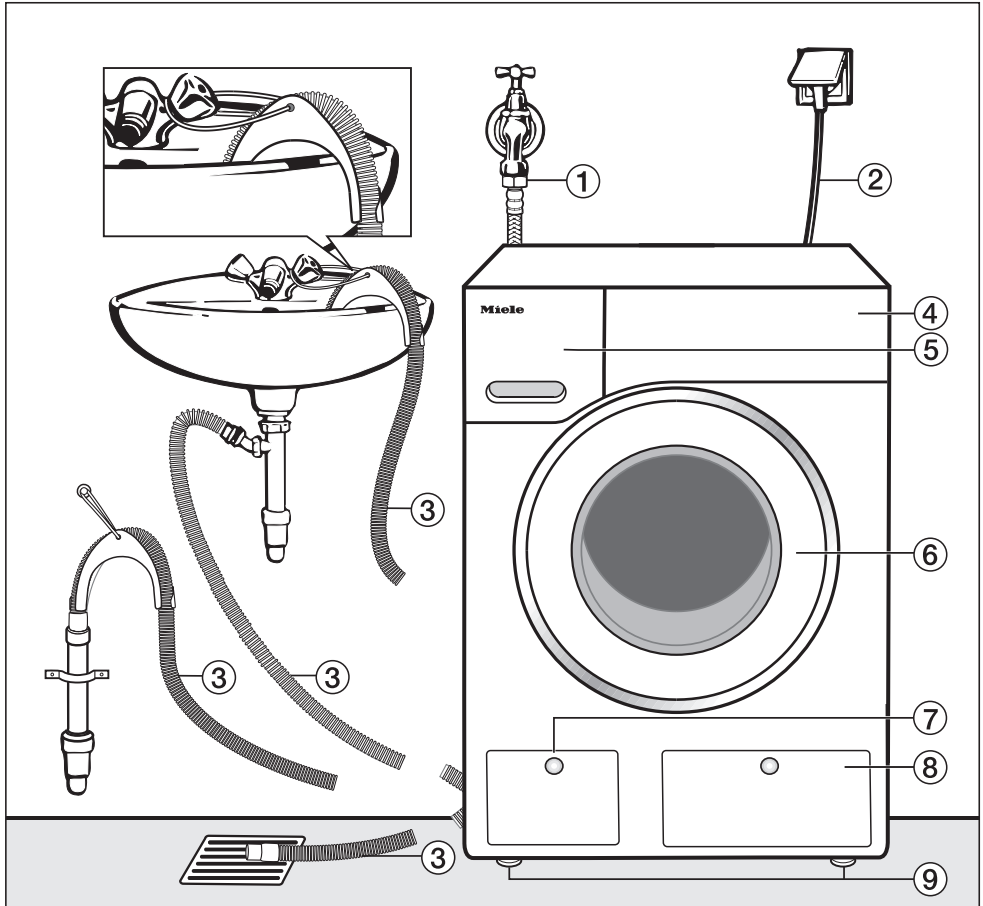

- ① Water inlet hose (waterproof metal, braided)
- ② Electrical connection
- ③ Flexible drain hose (with detachable elbow)
- ④ Control panel
- ⑤ Detergent drawer
- ⑥ Door
- ⑦ Access to drain filters, drain pump and emergency release
- ⑧ Access panel for TwinDos containers
- ⑨ 4 height-adjustable feet

Rear view

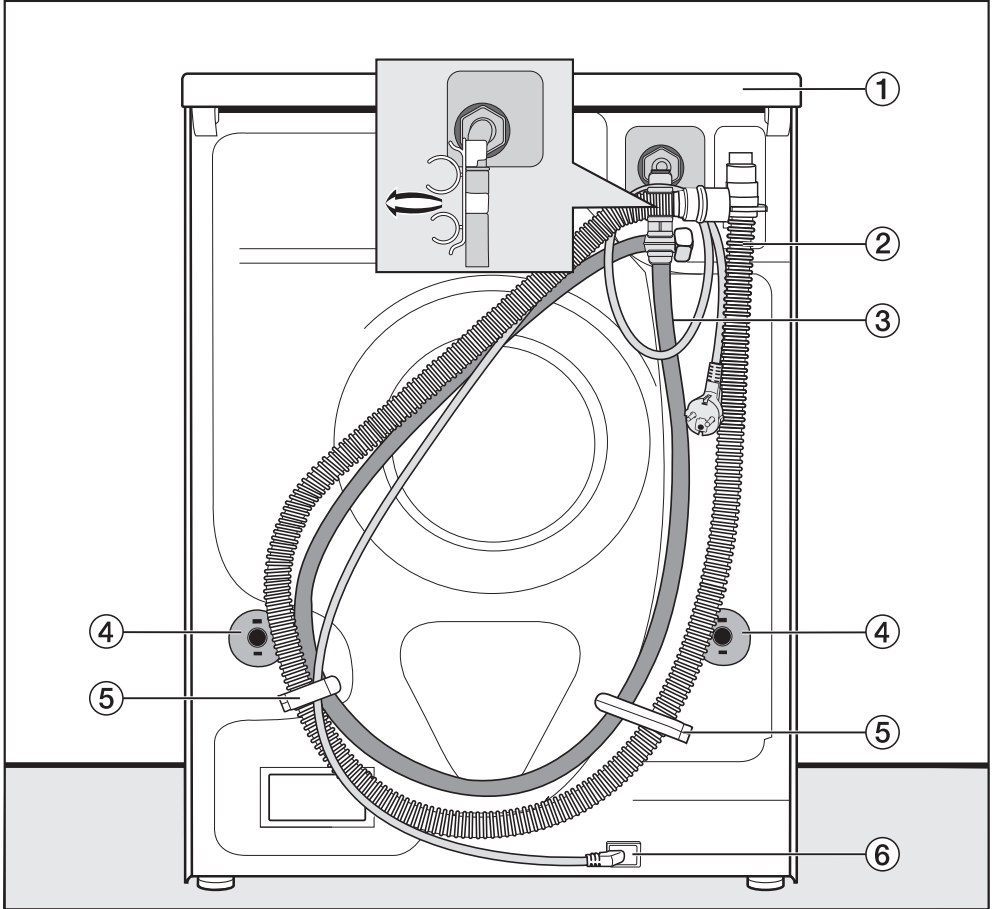

- ① Protruding lid for holding when moving the appliance
- ② Drain hose
- ③ Water inlet hose
- ④ Safety caps for transit bars
- ⑤ Transport clips for water inlet hoses and drain hoses
- ⑥ Electrical connection

Installation

Installation surface

A concrete floor is the most suitable installation surface. It is far less prone to vibration during the spin cycle than wooden floorboards or a carpeted surface.

Please note:

- The washer-dryer must be level and securely positioned.
- To avoid vibrations during spinning, the washer-dryer must not be installed on soft floor coverings.

If installing on a wooden joist floor, please note:

- Use a plywood base underneath the washer-dryer (at least 59 x 52 x 3 cm). The base must span several joists and be bolted to the joists and not only to the floorboards.

Tip: If possible, install the washer-dryer in a corner of the room, as this is usually the most stable part of the floor.

! Danger of injury due to unsecured washer-dryer.

If the washer-dryer is installed on an existing on-site plinth (concrete or brick), there is a danger of the machine falling off the plinth during the spin cycle.

Secure the washer-dryer with a fastening bracket (optional accessory).

Carrying the washer-dryer to its installation site

! Danger of injury due to unsecured lid.

The fixings at the back of the lid could break as a result of external forces. There is a danger of the lid being pulled off when carrying the machine.

Before carrying the machine, check that the lid is secure where it protrudes at the back of the machine.

- Carry the washer-dryer by the front feet and by the lid where it protrudes at the back of the machine.

Removing the transit bars

Removing the left-hand transit bar

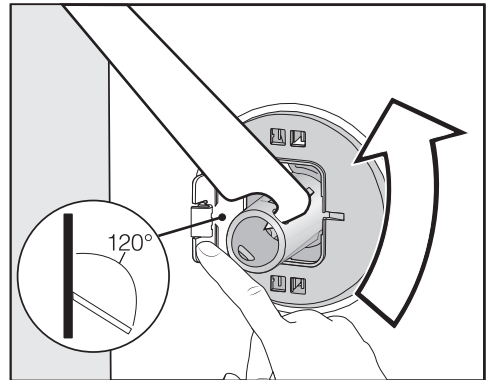

- Push the cover out and turn the left-hand transit bar 90° using the open spanner supplied.

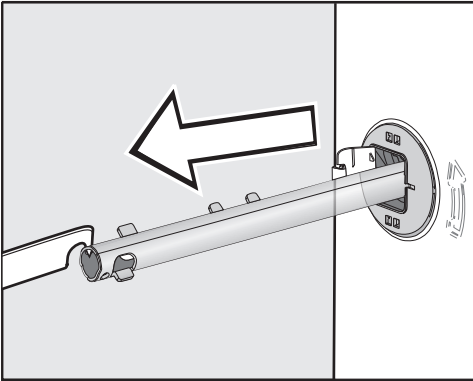

- Pull out the transit bar.

Removing the right-hand transit bar

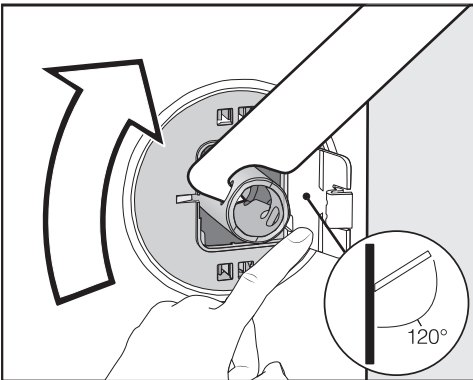

- Push the cover out and turn the left-hand transit bar 90° using the open spanner supplied.

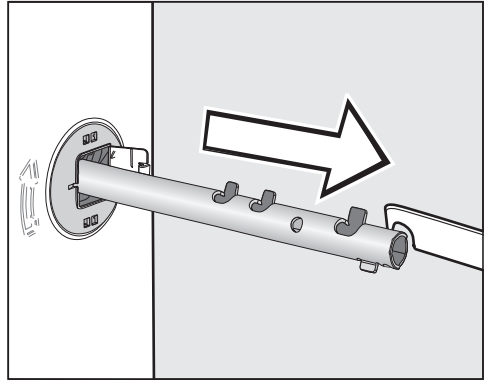

- Pull out the transit bar.

Covering holes

⚠ Danger of injury from sharp edges.

There is a danger of injury from reaching into holes that are not covered.

Cover the holes for the transit bars after they have been removed.

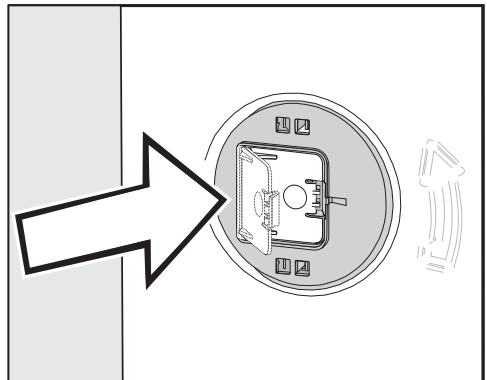

- Push the covers in firmly until they engage in position.

Installation

Refitting the transit bars

 Risk of damage from incorrect transport.

The washer-dryer may become damaged if moved without the transit bars in place.

Keep the transit bars in a safe place. Fit them again if the washer-dryer is to be moved (e.g. when moving house).

Opening the covers

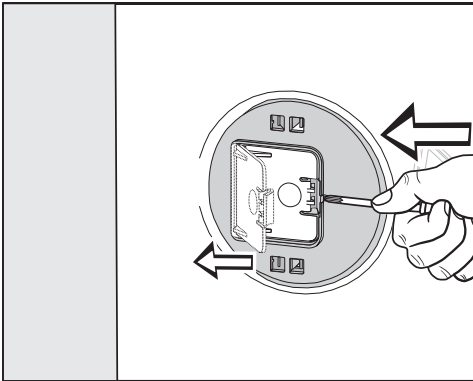

- Press against the retainer with a sharp object (a narrow screwdriver, for example).

The cover will open.

Fitting the transit bars

- To fit the bars, follow the instructions for removing them in reverse order.

Tip: The bars will slide in more easily if you lift the drum slightly.

Installing under a worktop

Building under kits* must only be installed/dismantled by a specialist.

- A special **building under kit*** is required. The cover plate included in the building under kit* replaces the lid of the washer-dryer. It is necessary to fit the cover plate for electrical safety reasons.
- Connections for electricity, water and drainage should be installed in such a way that they remain accessible when the washer-dryer is in its final position.

The building under kit includes installation instructions.

* Optional accessories

Aligning the washer-dryer

The washer-dryer must stand perfectly level on all four feet to ensure safe and proper operation.

Incorrect installation may increase electricity and water consumption and may cause the washer-dryer to move about.

Screwing out and adjusting the feet

The 4 adjustable feet are used to level the washer-dryer. The appliance is supplied with all feet screwed in.

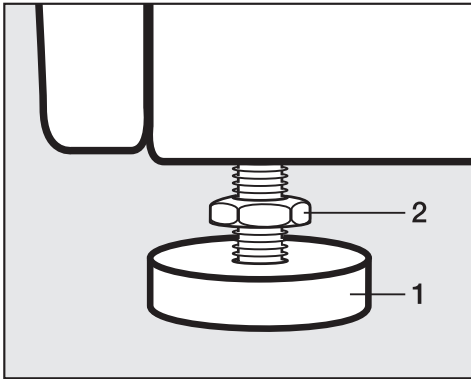

- Using the open spanner supplied, turn counter nut **2** in a clockwise direction. Then turn counter nut **2** together with foot **1** to unscrew.

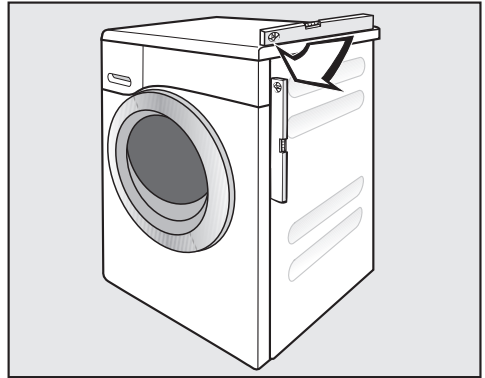

- Use a spirit level to check the washer-dryer is standing level.
- Hold foot **1** securely with a pipe wrench. Turn counter nut **2** again using the open spanner supplied until it sits firmly up against the casing.

 Risk of damage from incorrectly aligned washer-dryer.

There is a danger of the washer-dryer moving about if the feet are not secured.

Turn all 4 counter nuts for the feet until they sit firmly up against the casing. Please also check this for the feet which did not need adjustment.

Installation

The water protection system

The Miele water protection system protects all parts of the washer-dryer from water damage.

The system mainly consists of the following components:

- the inlet hose
- the electronic unit and drainage and overflow protection
- the drain hose

Inlet hose

- Protects the safety valve from bursting

The inlet hose can withstand pressure greater than 14,000 kPa.

- The inlet hose has a protective sleeve.

The inlet hose has metal braiding as a “second skin” to protect against damage.

Electronic unit and casing

- The floor tray

Any leaking water is collected in a floor tray in the base of the washer-dryer. A float switches off the water inlet valves. Further water intake is blocked. The water inside the suds container is pumped down.

- Overflow protection

This prevents the washer-dryer from taking in too much water and overflowing. If the water level exceeds a certain level, the drain pump switches on and pumps the excess water away.

Drain hose

The drain hose is protected by a ventilation system which prevents the washer-dryer from being emptied completely.

Water intake

 Health risk and risk of damage due to contaminated incoming water. The quality of the incoming water must correspond to the drinking water specification of the country in which the machine is being operated. Always connect the washing machine to the mains water supply.

The washer-dryer is not required to have a non-return valve connected to the mains water supply as the washing machine has been designed to comply with DIN regulations in Germany.

The water inlet pressure must be at least 100 kPa and must not exceed an overpressure of 1000 kPa. If the pressure exceeds 1000 kPa, a pressure reducing valve must be installed.

Connection to the mains water supply should incorporate a stopcock with a $\frac{3}{4}$ " screw thread. If no stopcock is available, only a qualified installer may connect the washer-dryer to the mains water supply.

The connection point is subject to mains water pressure. You should open the stopcock slowly and check for leaks. Correct the position of the seal and screw thread if water escapes.

The washer-dryer is **not** suitable for connection to a hot water supply.

Maintenance

Only use a genuine Miele hose that has been pressure tested to withstand at least 14,000 kPa should you ever need a replacement.

The dirt filter in the union nut at the open end of the water protects the water intake valve. This filter must not be removed.

Hose extension

A 1.5 metre long metal extension hose is available from Miele as an optional accessory.

Installation

Water drainage

The suds are drained through a drain pump with a 1 m delivery head. For the water to drain freely, the hose must be free of kinks. The elbow piece supplied hooks onto the end of the hose. If required, the hose can be extended to a length of up to 5 m. Accessories are available from Miele or from your Miele dealer.

For a delivery head of more than 1 m (up to a max. of 1.8 m) a replacement drain pump will need to be fitted. Please contact Miele for advice. With a delivery head in excess of 1 m the hose can be extended to a maximum of 2.5 m. Accessories are available from Miele or from your Miele dealer.

Drainage options:

1. Directed into a sink or basin:

Please note:

- Hook the hose over the edge and secure it.
- If the water is pumped into a washbasin, make sure that it can drain away freely. Otherwise there is a risk of water overflowing or of some of the drained water being sucked back into the machine.

2. Connected securely to a plastic drain pipe with a rubber nipple (there is no need to use a siphon).

3. Connected securely to a floor drain (gully).

4. Connected securely to a washbasin with a plastic nipple.

Connected securely to a washbasin

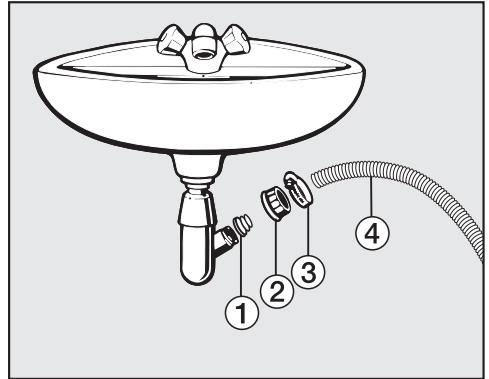

- ① Adapter
- ② Spigot nut
- ③ Hose clip
- ④ End of the hose

- Fit adapter ① to the sink drain outlet using nut ②.
- Attach the end of hose ④ to adapter ①.
- Use a screwdriver to tighten hose clip ③ up close to the nut.

Electrical connection

The washer-dryer is supplied with a mains cable with moulded plug ready for connection to a suitable earthed socket.

The socket must be easily accessible after the washer-dryer has been installed. If that is not possible, ensure that a suitable means of disconnection is provided on the installation side for each pole.

 Risk of fire from overheating. Connecting the washer-dryer to a multi-socket adapter or to an extension lead can overload the cable. For safety reasons, do not use an extension lead or multi-socket adapter.

The electrical system must comply with local and national safety regulations (BS 7671 in the UK). We recommend the use of a suitable RCD .

If the mains connection cable is damaged, it must only be replaced with a specific mains connection cable of the same type (available from the Miele Customer Service Department). For safety reasons, such replacement may only be carried out by a qualified technician or the Miele Customer Service Department.

These operating instructions and the data plate indicate the nominal power consumption and the appropriate fuse rating. Compare this information with the data of the on-site electrical connection.

If in any doubt, consult a qualified electrician.

Temporary or permanent operation on an autonomous power supply system or a power supply system that is not synchronised with the mains power supply (e.g. island networks, back-up systems) is possible. A prerequisite for operation is that the power supply system complies with the specifications of EN 50160 or an equivalent standard. The function and operation of the protective measures provided in the domestic electrical installation and in this Miele product must also be maintained in isolated operation or in operation that is not synchronised with the mains power supply, or these measures must be replaced by equivalent measures in the installation. As described, for example, in the current version of BS OH-SAS 18001–2 ISO 45001.

Garment care label symbols

Washing	
The figure quoted in the bucket is the maximum temperature at which the garment can be washed.	
	Normal agitation
	Reduced agitation
	Much reduced agitation
	Hand wash
	Do not wash

Programme selection examples

Programme	Care symbols
ECO 40-60	
Cottons	
Minimum iron	
Delicates	
Woolens	

Drying	
	Normal temperature
	Low temperature
	Do not tumble dry

Ironing	
	Approx. 200 °C
	Approx. 150 °C
	Approx. 110 °C
	Ironing with steam can cause irreversible damage.
	Ironing/rotary ironing prohibited

Professional cleaning	
	Dry clean only. The letters indicate the type of cleaning agent required.
	Wet cleaning
	Dry cleaning prohibited

Bleaching	
	Any oxidation bleach can be used
	Use oxygen bleach only
	Do not bleach

Technical data

Height	850 mm
Width	596 mm
Depth	637 mm
Depth with door open	1055 mm
Height for building under	820 (+8/-2) mm
Width for building under	600 mm
Weight	Approx. 98 kg
Capacity, washing	8.0 kg dry laundry
Capacity, drying	5.0 kg dry laundry
Supply voltage	See data plate
Rated load	See data plate
Fuse rating	See data plate
Consumption data	See "Consumption data"
Minimum water flow pressure	100 kPa (1 bar)
Maximum water flow pressure	1000 kPa (10 bar)
Water inlet hose length	1.55 m
Drain hose length	1.50 m
Connection cable length	2.00 m
Maximum delivery head	1.00 m
Maximum drainage length	5.00 m
LEDs	Class 1
Test certifications awarded	See data plate
Power rating in off mode	0.10
Networked standby	0.50
Frequency band of the WiFi module	2.4000 GHz – 2.4835 GHz
Maximum transmitting power of the WiFi module	< 100 mW

Technical data

EU Conformity declaration

Miele hereby declares that this washing machine complies with Directive 2014/53/EU.

The complete text of the EU declaration of conformity is available from one of the following internet addresses:

- Products, Download from www.miele.ie
- For service, information, operating instructions etc: go to www.miele.ie/domestic/customer-information-385.htm and enter the name of the product or the serial number

UK Conformity declaration

Miele hereby declares that this washing machine complies with UK Radio Equipment Regulations 2017, as amended.

The complete text of the UK declaration of conformity is available from one of the following internet addresses:

- Products, Download from www.miele.co.uk
- For service, information, operating instructions etc: go to www.miele.co.uk and enter the name of the product or the serial number

Programmes	Load kg	Energy kWh	Water litres	Programme running time h:min	Temperature ¹ °C	Residual moisture %	Spin speed rpm
Main wash							
ECO 40–60*	8.0	0.80	60	3:39	35	44	1600
	4.0	0.30	52	2:39	28	43	1600
	2.0	0.20	28	2:29	25	46	1600
Cottons	8.0	1.35	57	2:29	54	50	1600
	20	0.35	72	2:39	20	50	1600
Minimum iron	3.5	0.32	47	1:59	30	30	1200
Express ²	40	0.33	30	0:20	27	60	1200
	30	0.23	35	0:39	–	–	–
QuickPower	40	0.58	40	0:49	–	–	–
Washing and drying							
ECO 40–60* Normal	5.0	3.30	85	6:29	30	0	1600
	2.5	1.60	43	3:59	24	0	1600

* Test programme for compliance with EU legislation regarding ecodesign 2019/2023 and energy labelling in accordance with Regulation No. 2019/2014

¹ Maximum laundry temperature reached in main wash.

² Quick Extra activated

TwinDos dispensing must be deactivated when carrying out comparison tests.

Information for customers

Consumption data can vary from the nominal values given depending on water pressure, water hardness, water inlet temperature, room temperature, type and volume of load, fluctuations in the mains voltage and any extra options selected.

Settings

The settings are used to alter the washer-dryer's electronics to suit different requirements. Settings can be altered at any time.

Accessing the Settings menu

- Switch the washer-dryer on.
- Scroll through the main menu until **Settings** appears.
- Touch the **Settings** sensor control.

The display will change to show the Settings menu.

Selecting settings

The settings are grouped into different areas.

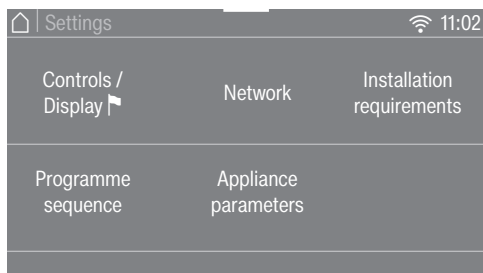

- Select the required area.
- Scroll through the list until the setting you want appears.
- Touch the sensor to select the setting you require.

Changing a setting

- Change the value displayed and confirm with **OK** ...
- ... or touch an option to select it.

An option which is selected will be highlighted orange.

The option is saved. The display will then switch to the Settings menu, or go back to the previous menu level.

Closing the Settings menu

- Touch the  sensor control.

The display will then go back to the previous menu level.

- Touch the  sensor control.

The display will change to the main menu.

Controls / Display ▾

Language ▾

The display can be set to appear in one of several different languages.

The ▾ flag after the word *Language* (Sprache in German) acts as a guide in case a language which is not understood has been set.

The language selected is saved.

Code

The PIN code prevents the washer-dryer being used without your knowledge.

Options

- Activate

The code is 125 and can be activated. When the PIN code has been activated, you have to enter the code after switching the washer-dryer on. Otherwise the washer-dryer cannot be operated.

- Deactivate

For using the washer-dryer without entering the code. This only appears if the PIN code had been activated previously.

- Change

You can enter any code.

If you forget the PIN code, the washer-dryer will have to be unlocked by the Miele Customer Service Department.
Make a note of your new PIN code.

Memory

The washer-dryer will save the last settings selected for a programme (temperature, spin speed and some of the Extras) after the programme has started.

The next time that programme is used the washer-dryer will show those settings in the display.

Factory default setting: Memory is switched off.

Clock display

If the clock format has been set, the time of day can be set.

Clock format

- 24 h clock (factory default)
- 12 h clock

Set

- The time can be set.

Volume

The volume for various sounds can be changed.

- Finish tone
- Keypad tone
- Welcome tone

It can be set to one of 7 different levels or switched off altogether.

Settings

Display brightness

The brightness of the display can be altered.

They can be set to one of 7 different levels.

Temperature unit

The temperature can be displayed as degrees °C/Celsius or °F/Fahrenheit.

Factory default setting: °C/Celsius.

Programme sequence

TwinDos

You can set and check the type of detergent and dispensing quantities.

Select detergent

If you wish to use your own detergent with the TwinDos function instead of UltraPhase 1 and 2, you will need TwinDos refill containers separately (optional accessories).

UltraPhase 1 and 2 can only be dispensed as a package. If a different agent is selected, the setting for the other compartment is automatically deleted.

The following agents can be used:

- Miele UltraPhase 1
- Miele UltraPhase 2
- Universal detergent
- Colour detergent
- Delicates detergent
- Delicates/Woollens
- Fabric conditioner

Follow the manufacturer's instructions on dosage given on the packaging.

The dosage amount required for the agent being used must be set. Follow the instructions in the display on how to do so.

Tip: If you select No agent the respective TwinDos compartment will be deactivated.

Change dosage

The values set for dispensing detergent from compartments ① and ② can be checked and corrected.

Soiling

You can specify the default setting for the degree of soiling.

- Light
- Normal (factory default)
- Heavy

Water plus level

There are 4 different water levels which can be selected by activating the *Water plus Extra*.

Options

- Normal (factory default)
- Plus ∂
- Plus ∂∂
- Plus ∂∂∂

Maximum rinse level

The water level in the rinses can be permanently set to the highest value.

This function is important for allergy sufferers as it achieves excellent rinse results. The water consumption will be increased.

The function is switched off in the factory default setting.

Soak duration

You can set a soak duration of between 30 minutes and 6 hours.

The duration can be selected in 30 minute increments. When the *Soak Extra* is selected, the laundry will be soaked for the duration selected.

A duration of 0:30 h is set as standard.

Settings

Longer Pre-wash Cottons

If you require a longer pre-wash, you can extend the standard pre-wash time of 25 minutes.

Options

- Normal (factory default)
25 minute pre-wash.
- + 6 min
31 minute pre-wash.
- + 9 min
34 minute pre-wash.
- + 12 min
37 minute pre-wash.

Gentle action

With gentle action activated, drum agitation is reduced. In this way, lightly soiled items can be washed more gently.

Gentle action can be activated for the *Cottons* and the *Minimum iron* programmes.

If gentle action is activated, each wash phase in the programme selected will be run with the gentle action wash rhythm.

Factory default setting: gentle action is switched off.

Comp laundry protection

The maximum final spin speed can be limited to prevent laundry forming a ring around the drum.

The **Comp laundry protection** setting is only effective with continuous washing and drying.

Options

- Off
- 900 (factory default)
- 1000
- 1100
- 1200

Drying levels

You can adjust the drying levels in the *Cottons*, *Minimum iron* and *Automatic plus* programmes if needed.

They can be set to one of 7 different levels.

Extended cool down

The cooling down phase which takes place before the end of a programme can be extended if required. This cools the garments down even more. The cooling down phase can only be extended if a drying level has been selected. Extended cool down is not active for timed drying.

The extended cool down time can be set between 0 min (factory default) and 18 min.

Network

Miele@home

Control the networking of your washer-dryer with your home WiFi network.

Options

- Set up

This message only appears if the washer-dryer has not yet been connected to a WiFi network.

Please refer to “Before using for the first time” for instructions on how to set up the connection.

- Deactivate

The setting is only visible if Miele@home is activated.

Miele@home remains set up, the WiFi function is switched off.

- Activate

The setting is only visible if Miele@home is deactivated.

The WiFi function is reactivated.

- Connection status

The setting is only visible if Miele@home is activated.

The WiFi reception quality, network name and IP address are displayed.

- Set up again

The setting is only visible if Miele@home is set up.

Resets the WiFi login (network) to immediately re-establish a new connection.

Settings

- Reset

The setting is only visible if Miele@home is set up.

The WiFi function is deactivated and the WiFi connection will be reset to the factory default.

The network configuration should be reset whenever a washer-dryer is being disposed of or sold, or if a used washer-dryer is being put into operation. This is the only way to ensure that all personal data has been removed and the previous owner will no longer be able to access the washer-dryer.

A new connection setup has to be carried out in order to use Miele@home again.

Remote control

The Remote control setting is only visible if the Miele@home setting is set up and activated.

If the Miele App has been installed on your mobile device, you can check the status of your washer-dryer from anywhere and start it remotely.

You can also operate your washer-dryer remotely with the *MobileStart* programme.

You can switch off the Remote control setting if you do not want to operate the washer-dryer with your mobile device.

If Remote control is not switched on, the app can still be used to cancel the programme.

Use the “Delay start” sensor to set a time by which you want to start the washer-dryer and start the delay start

(see “Delay start/SmartStart”).

The washer-dryer will then start within the specified timeframe when it receives your signal.

If it has not received a start signal by the latest start time set, the washer-dryer will start automatically.

Remote control is switched off in the factory default setting.

SmartGrid

The SmartGrid setting is only visible if the Miele@home setting is set up and activated.

This function can be used for starting your washer-dryer automatically at a time when the energy tariff of your energy supplier is more economical.

Activating SmartGrid gives the *Delay start* button a new function.

Set the SmartStart by using the “Delay start” sensor (see “Delay start/SmartStart”).

The washer-dryer will then start within the timeframe specified when it receives a signal from the energy supplier.

If a signal has not been received from the energy supplier by the latest start time set, the washer-dryer will start automatically.

The SmartGrid function is switched off in the factory default setting.

Remote Update

The Remote Update menu option is only displayed and can only be selected if the requirements for using Miele@home have been met (see “Before using for the first time” – “Miele@home”).

The RemoteUpdate function is used for updating the software in your washer-dryer. If an update is available for your washer-dryer, it will automatically download it. Updates will not be installed automatically. They must be initiated manually.

If you do not install an update, you can continue to use your washer-dryer in the usual way. However, Miele recommends installing updates.

Activating/deactivating

The RemoteUpdate function is activated as standard. Available updates will be downloaded automatically but will only be installed if you initiate installation manually.

Deactivate RemoteUpdate if you do not want any updates to be downloaded automatically.

Running a RemoteUpdate

Information about the content and scope of an update will be provided in the Miele app.

A message will appear in your washer-dryer display if a software update is available.

You can install the update immediately or postpone this until later. When the washer-dryer is switched on again, you will be reminded about the update.

Deactivate RemoteUpdate if you do not want to install the update.

The update may take several minutes.

Please note:

- You will only receive a message when an update is available.
- Once an update has been installed, it cannot be undone.
- Do not switch off the washer-dryer during an update. Otherwise, the update will be aborted and will not be installed.
- Some software updates can only be carried out by the Miele Customer Service Department.

Settings

Appliance parameters

Copyrights and licences for operator and control software

Miele uses their own and third party software which is not subject to any so-called Open Source Licence for the operation and control of the appliance. This software/these software components are protected by copyright. The copyright powers of Miele and third parties have to be respected.

Furthermore, this appliance contains software components which are distributed under Open Source licence conditions. Please refer to the menu item Settings | Appliance parameters | Legal information | Open source licences in the appliance for the Open Source components contained therein, together with the corresponding copyright notices, copies of the licencing conditions valid at the time, and any further information. The liability and warranty provisions of the Open Source licence terms and conditions as stated therein apply only in relation to the respective rights holders.

Copyrights and licences for the communication module

For the purpose of operating and controlling the communication module, Miele uses proprietary or third-party software that is not covered by open source licensing terms. These items of software/software components are protected by copyright. The copyrights held by Miele and third parties must be respected.

Furthermore, this communication module contains software components which are distributed under open source licence conditions. The open source components contained in the appliance along with the corresponding copyright notices, copies of the licensing terms valid at the time, and any further information can be accessed locally via IP using a web browser (*http://<IP address>/Licenses*). The liability and warranty arrangements for the open source licences displayed in this location only apply in relation to the respective rights holders.

Installation requirements

Low water pressure

If the water pressure is too low, the washer-dryer will stop the programme and a water inlet fault message will appear.

This setting can be activated to ensure problem-free water intake where the water pressure is constantly low.

Factory default setting: Low water pressure is switched on.

Suds cooling

Additional water flows into the drum at the end of the main wash to cool the suds down.

Suds cooling takes place when a Cottons programme with a temperature of 70 °C or higher is selected.

Activate suds cooling:

- To prevent the danger of scalding if the drain hose is hooked over the edge of a sink or slops basin
- In buildings where the drainage pipes do not comply with DIN 1986

Factory default setting: suds cooling is switched off.

Temperature reduction

At high altitudes, water has a lower boiling point. Miele recommends activating the reduced temperature setting at altitudes of 2000 m or above to prevent water from boiling. The maximum temperature is reduced to 80 °C even if a higher temperature is selected.

Factory default setting: the reduce temperature setting is switched off.

Detergents and care products

Detergent, fabric care, additives and machine care products are available for this washing machine. All the products have been designed for Miele washing machines.

These and many other useful products can be ordered via the internet at www.miele.co.uk or from Miele (see end of this booklet for contact details).

Detergent

Miele UltraPhase 1 and 2

- 2-component detergent for whites and colours
- For brilliant colours and spotlessly white laundry
- Excellent stain removal even at low temperatures

UltraWhite (powder detergent)

- Best results at 20/30/40/60/95 °C
- Radiant white laundry thanks to powerful formula with active oxygen
- Excellent stain removal even at low temperatures

UltraColor (liquid detergent)

- Best wash results at 20/30/40/60 °C
- With colour-protection formula for brilliant colours
- Excellent stain removal even at low temperatures

WoolCare delicates detergent (liquid detergent)

- For wool, silks and delicates
- Special care complex based on wheat protein and with colour-protection formula
- Best wash results at 20/30/40/60 °C

Specialist detergents

These specialist detergents are available as convenient single-use capsules.

Caps Sport

- For synthetic fabrics
- Neutralises odours thanks to built-in odour absorber
- Prevents static charge in clothes
- Retains the shape and breathability of synthetic fabrics

Caps DownCare

- For down-filled items
- Retains the elasticity and breathability of down
- Lanolin for effective cleaning and gentle care
- Down does not stick together and retains its loft

Caps WoolCare

- Woollens and delicates detergent
- Special wheat-protein-based agents
- Fibre-protection technology to help prevent items shrinking and felting
- Colour-protection formula for gentle cleaning

Caps UltraDark

- Special-purpose detergent for dark and black laundry
- Colour-protection formula for gentle cleaning
- Anti-pilling effect protects your garments from discolouration
- Retains colour intensity and brightness

Caps CottonRepair

- Special-purpose detergent for cotton fabrics
- Visibly renews fabric with just one wash
- Special Miele formula with No-vozymes technology
- Removes pilling and renews colour intensity and brightness
- Depending on fabric do not use more than 1–2 times per year

Caps SilkCare

- Silks and delicates detergent
- Special care product made with silk protein
- Preserves the smooth surface of silk textiles
- Gentle cleaning to protect silk fibres

Detergents and care products

Fabric care

These fabric care products are available as convenient single-use capsules.

Fabric conditioner cap

- Fabric conditioner for freshly scented laundry
- Pure and thorough cleanliness with a fresh scent
- For soft, bouncy laundry
- Prevents static charge in clothes

Cap Impraprotect

- Proofing agent for sportswear and waterproof clothing
- Effective proofing to protect against water and wind, and to give a dirt-repellent finish
- Retains the breathability of fabrics

Additives

Additives are available as convenient single-use capsules.

Cap Booster

- Highly effective stain remover
- Enzyme technology to help remove stubborn stains
- Suitable for whites and colours
- For best wash results even at low temperatures

Machine care

TwinDosCare

- Cleaning agent for the TwinDos dispensing system
- Use before a prolonged downtime (at least 2 months)
- Use before changing to a different product

Descaling agent

- Removes heavy limescale deposits
- Mild and gentle with natural citric acid
- Gentle on heater elements, drum and other components

IntenseClean

- For hygienic cleanliness in washing machines
- Removes grease, bacteria and associated unpleasant odours
- Effective thorough cleaning

Water softener tablets

- Reduces the amount of detergent needed for hard water
- Less detergent residue in fabrics
- Less chemicals in waste water due to reduced amount of detergent

United Kingdom

Miele Co. Ltd., Fairacres, Marcham Road, Abingdon, Oxon, OX14 1TW
Tel: 0330 160 6600, Internet: www.miele.co.uk/service, E-mail: info@miele.co.uk

Australia

Miele Australia Pty. Ltd.
ACN 005 635 398
ABN 96 005 635 398
1 Gilbert Park Drive
Knoxfield, VIC 3180
Tel: 1300 464 353
Internet: www.miele.com.au

China Mainland

Miele Electrical Appliances Co., Ltd.
1-3 Floor, No. 82 Shi Men Yi Road
Jing' an District
200040 Shanghai, PRC
Tel: +86 21 6157 3500
Fax: +86 21 6157 3511
E-mail: info@miele.cn
Internet: www.miele.cn

Hong Kong, China

Miele (Hong Kong) Ltd.
41/F - 4101, Manhattan Place
23 Wang Tai Road
Kowloon Bay, Hong Kong
Tel: (852) 2610 1025
Fax: (852) 3579 1404
Email:
customerservices@miele.com.hk
Website: www.miele.hk

India

Miele India Pvt. Ltd.
1st Floor, Copia Corporate Suites,
Commercial Plot 9,
Mathura Road, Jasola,
New Delhi - 110025
E-mail: customercare@miele.in
Website: www.miele.in

Ireland

Miele Ireland Ltd.
2024 Bianconi Avenue
Citywest Business Campus
Dublin 24
Tel: (01) 461 07 10
Fax: (01) 461 07 97
E-Mail: info@miele.ie
Internet: www.miele.ie

Malaysia

Miele Sdn Bhd
Suite 12-2, Level 12
Menara Sapura Kencana
Petroleum
Solaris Dutamas No. 1
Jalan Dutamas 1
50480 Kuala Lumpur, Malaysia
Phone: +603-6209-0288
Fax: +603-6205-3768

New Zealand

Miele New Zealand Limited
IRD 98 463 631
8 College Hill
Freemans Bay, Auckland 1011
New Zealand
Tel: 0800 464 353
Internet: www.miele.co.nz

Singapore

Miele Pte. Ltd.
29 Media Circle
#11-04 ALICE@Mediapolis
Singapore 138565
sTel: +65 6735 1191
Fax: +65 6735 1161
E-Mail: info@miele.com.sg
Internet: www.miele.sg

South Africa

Miele (Pty) Ltd.
63 Peter Place
Bryanston 2194
P.O. Box 69434
Bryanston 2021
Tel: (011) 875 9000
Fax: (011) 875 9035
E-mail: info@miele.co.za
Internet: www.miele.co.za

Thailand

Miele Appliances Ltd.
BHIRAJ TOWER at EmQuartier
43rd Floor Unit 4301-4303
689 Sukhumvit Road
North Klongton Sub-District
Vadhana District
Bangkok 10110, Thailand

United Arab Emirates

Miele Appliances Ltd.
Showroom 1
Eiffel 1 Building
Sheikh Zayed Road, Umm Al Sheif
P.O. Box 114782 - Dubai
Tel. +971 4 3044 999
Fax. +971 4 3418 852
800-MIELE (64353)
E-Mail: info@miele.ae
Website: www.miele.ae

Manufacturer: Miele & Cie. KG, Carl-Miele-Straße 29, 33332 Gütersloh, Germany

WTR 860 WPM

en-GB

M.-Nr. 12 029 760 / 00