

Haier SERVICE MANUAL

Wall Mounted Type DC Inverter Model No.1U71SABFRA



WARNING

This service information is designed for experienced repair technicians only and is not designed for use by the general public. It does not contain warnings or cautions to advise non-technical individuals of potential dangers in attempting to service a product. Products powered by electricity should be serviced or repaired only by experienced professional technicians. Any attempt to service or Repair the product or products dealt with in this service information by anyone else could result in serious injury or death

(Qingdao Haier Air Conditioner General corp. , Ltd)
All rights reserved. Unauthorized copying and distribution is a violation of law

Haier Group

Version: V1

Date: 2018-06-29

Contents

1. Introduction	1
2. Specifications.....	7
3. Sensors list	8
4. Piping diagrams	9
5. Operation range	10
6. PCB Diagram	11
7. Functions and Control.....	15
8. Dimensional drawings.....	30
9. Center of gravity	30
10. Service Diagnosis	31
11. Performance and curves diagrams.....	45
12. Circuit diagrams.....	53

1 Introduction

1.1 Model name explanation

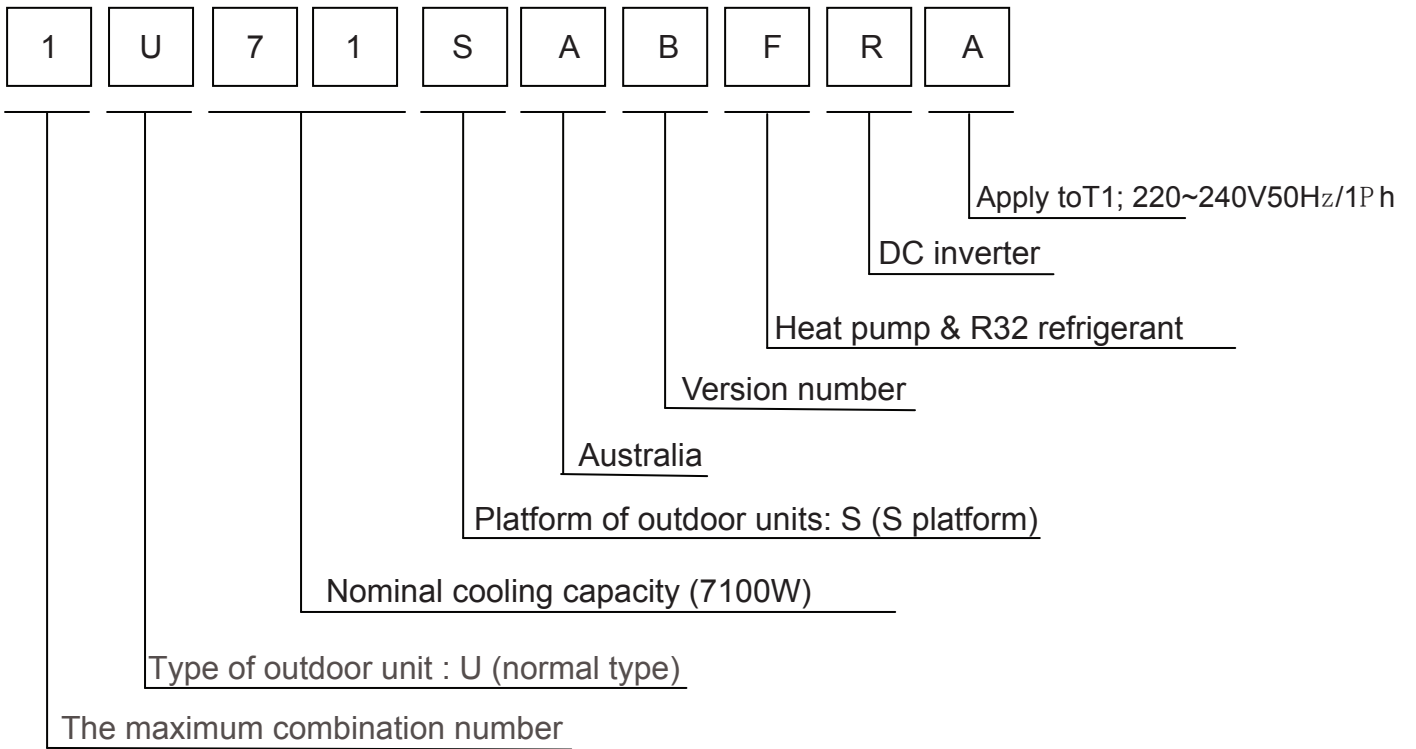

1.2 Safety Cautions

Be sure to read the following safety cautions before conducting repair work.

The caution items are classified into “Warning” and “Caution”. The “Warning” items are especially important since they can lead to death or serious injury if they are not followed closely. The “Caution” items can also lead

to serious accidents under some conditions if they are not followed. Therefore, be sure to observe all the safety

caution items described below.

About the pictograms

△ This symbol indicates an item for which caution must be exercised.

The pictogram shows the item to which attention must be paid.

○ This symbol indicates a prohibited action.





The prohibited item or action is shown inside or near the symbol.

● This symbol indicates an action that must be taken, or an instruction.







The instruction is shown inside or near the symbol.

After the repair work is complete, be sure to conduct a test operation to ensure that the equipment operates Normally, and explain the cautions for operating the product to the customer.

1.2.1 Caution in Repair

Warning	
<p>Be sure to disconnect the power cable plug from the plug socket before disassembling the equipment for a repair.</p> <p>Working on the equipment that is connected to a power supply can cause an electrical shock.</p> <p>If it is necessary to supply power to the equipment to conduct the repair or inspecting the circuits, do not touch any electrically charged sections of the equipment.</p>	
<p>If the refrigerant gas discharges during the repair work, do not touch the discharging refrigerant gas. The refrigerant gas can cause frostbite.</p>	
<p>When disconnecting the suction or discharge pipe of the compressor at the welded section, release the refrigerant gas completely at a well-ventilated place first.</p> <p>If there is a gas remaining inside the compressor, the refrigerant gas or cooling machine oil discharges when the pipe is disconnected, and it can cause injury.</p>	
<p>If the refrigerant gas leaks during the repair work, ventilate the area. The refrigerant gas can generate toxic gases when it contacts flames.</p>	
<p>The step-up capacitor supplies high-voltage electricity to the electrical components of the outdoor unit. Be sure to discharge the capacitor completely before conducting repair work. A charged capacitor can cause an electrical shock.</p>	
<p>Do not start or stop the air conditioner operation by plugging or unplugging the power cable plug. Plugging or unplugging the power cable plug to operate the equipment can cause an electrical shock or fire.</p>	





Warning	
Do not repair the electrical components with wet hands . Working on the equipment with wet hands can cause an electrical shock	
Do not clean the air conditioner by splashing water. Washing the unit with water can cause an electrical shock.	
Be sure to provide the grounding when repairing the equipment in a humid or wet place, to avoid electrical shock.	
Be sure to turn off the power switch and unplug the power cable when cleaning the equipment. The internal fan rotates at a high speed, and cause injury.	
Do not tilt the unit when removing it. The water inside the unit can spill and wet the furniture and floor.	
Be sure to check that the cooling cycle section has cooled down sufficiently before conducting repair work. Working on the unit when the cooling cycle section is hot can cause burns.	
Use the welder in a well-ventilated place. Using the welder in an enclosed room can cause oxygen deficiency.	

1.2.2 Cautions Regarding Products after Repair

Warning	
Be sure to use parts listed in the service parts list of the applicable model and appropriate tools to conduct repair work. Never attempt to modify the equipment. The use of inappropriate parts or tools can cause an electrical shock, excessive heat generation or fire.	
When relocating the equipment, make sure that the new installation site has sufficient strength to withstand the weight of the equipment. If the installation site does not have sufficient strength and if the installation work is not conducted securely, the equipment can fall and cause injury.	
Be sure to install the product correctly by using the provided standard installation frame. Incorrect use of the installation frame and improper installation can cause the equipment to fall, resulting in injury.	For integral units only
Be sure to install the product securely in the installation frame mounted on a window frame. If the unit is not securely mounted, it can fall and cause injury.	For integral units only





Warning	
<p>Be sure to use an exclusive power circuit for the equipment, and follow the technical standards related to the electrical equipment, the internal wiring regulations and the instruction manual for installation when conducting electrical work.</p> <p>Insufficient power circuit capacity and improper electrical work can cause an electrical shock or fire.</p>	
<p>Be sure to use the specified cable to connect between the indoor and outdoor units. Make the connections securely and route the cable properly so that there is no force pulling the cable at the connection terminals.</p> <p>Improper connections can cause excessive heat generation or fire.</p>	
<p>When connecting the cable between the indoor and outdoor units, make sure that the terminal cover does not lift off or dismount because of the cable.</p> <p>If the cover is not mounted properly, the terminal connection section can cause an electrical shock, excessive heat generation or fire.</p>	
<p>Do not damage or modify the power cable.</p> <p>Damaged or modified power cable can cause an electrical shock or fire. Placing heavy items on the power cable, and heating or pulling the power cable can damage the cable.</p>	
<p>Do not mix air or gas other than the specified refrigerant (R-410A / R22) in the refrigerant system.</p> <p>If air enters the cooling system, an excessively high pressure results, causing equipment damage and injury.</p>	
<p>If the refrigerant gas leaks, be sure to locate the leak and repair it before charging the refrigerant. After charging refrigerant, make sure that there is no refrigerant leak.</p> <p>If the leak cannot be located and the repair work must be stopped, be sure to perform pump-down and close the service valve, to prevent the refrigerant gas from leaking into the room. The refrigerant gas itself is harmless, but it can generate toxic gases when it contacts flames, such as fan and other heaters, stoves and ranges.</p>	
<p>When replacing the coin battery in the remote controller, be sure to disposed of the old battery to prevent children from swallowing it.</p> <p>If a child swallows the coin battery, see a doctor immediately.</p>	

Caution	
<p>Installation of a leakage breaker is necessary in some cases depending on the conditions of the installation site, to prevent electrical shocks.</p>	



<p>Do not install the equipment in a place where there is a possibility of combustible gas leaks. If a combustible gas leaks and remains around the unit, it can cause a fire.</p>	
<p>Be sure to install the packing and seal on the installation frame properly. If the packing and seal are not installed properly, water can enter the room and wet the furniture and floor.</p>	

1.2.3 Inspection after Repair

<p>Warning</p>	
<p>Check to make sure that the power cable plug is not dirty or loose, then insert the plug into a power outlet all the way. If the plug has dust or loose connection, it can cause an electrical shock or fire.</p>	
<p>If the power cable and lead wires have scratches or deteriorated, be sure to replace them. Damaged cable and wires can cause an electrical shock, excessive heat generation or fire.</p>	

<p>Warning</p>	
<p>Do not use a joined power cable or extension cable, or share the same power outlet with other electrical appliances since it can cause an electrical shock, excessive heat generation or fire.</p>	

<p>Caution</p>	
<p>Check to see if the parts and wires are mounted and connected properly, and if the connections at the soldered or crimped terminals are secure. Improper installation and connections can cause excessive heat generation, fire or an electrical shock.</p>	
<p>If the installation platform or frame has corroded, replace it. Corroded installation platform or frame can cause the unit to fall, resulting in injury.</p>	







<p>Check the grounding, and repair it if the equipment is not properly grounded. Improper grounding can cause an electrical shock.</p>	
<p>Be sure to measure the insulation resistance after the repair, and make sure that the resistance is 1 M ohm or higher. Faulty insulation can cause an electrical shock.</p>	
<p>Be sure to check the drainage of the indoor unit after the repair. Faulty drainage can cause the water to enter the room and wet the furniture and floor.</p>	

1.2.4 Using Icons

Icons are used to attract the attention of the reader to specific information. The meaning of each icon is described in the table below:

1.2.5 Using Icons List

Icon	Type of Information	Description
 Note	Note	A “note” provides information that is not indispensable, but may nevertheless be valuable to the reader, such as tips and tricks.
 Caution	Caution	A “caution” is used when there is danger that the reader, through incorrect manipulation, may damage equipment, lose data, get an unexpected result or has to restart (part of) a procedure.
 Warning	Warning	A “warning” is used when there is danger of personal injury.
	Reference	A “reference” guides the reader to other places in this binder or in this manual, where he/she will find additional information on a specific topic.



2. Specifications - 1U53RABFRA

NOMINAL DISTRIBUTION SYSTEM VOLTAGE		
Phase	/	1
Frequency	Hz	50
Voltage	V	220~240

NOMINAL CAPACITY and NOMINAL INPUT			
		cooling	heating
Capacity rated	W	7100(1900-8400)	7600(2000-10200)
	Btu/h	24200(6500-28600)	25900(6800-34800)
Power Consumption(Rated)	W	1710	1890
EER/ COP	W/W	4.15	4.02
Moisture Removal	m ³ /h	2.4*10 ⁻³	

TECHNICAL SPECIFICATIONS-UNIT			
Dimensions	H*W*D	mm	920×385×762
Packaged Dimensions	H*W*D	m	1085×487×843
Weight	/	KG	54
Gross weight	/	KG	60
Sound level	Sound pressure	dB	58
	Sound power	dB(A)	69

ELECTRICAL SPECIFICATIONS			
		cooling	heating
Nominal running current	A	7.51	8.24
Maximum running current	A	11.4	12.6

TECHNICAL SPECIFICATIONS-PARTS			
		cooling	heating
Compressor	Type	Rotary Compressor	
	Model	GTD186UKQA8JT6	
	Motor output	W	1800
	Oil type	A C S - 6 8 R	
	Oil charge volume	L	0.5
Fan	Type	Axial fan	
	Motor output	W	93/93
	Air flow rate(high)	m ³ /h	3400
	Speed(high/low)	rpm	850/300
Heat exchanger	Type	ML fin- φ 7HI-HX tube	
	Row*stage*fitch	2.5*34*1.4	

TECHNICAL SPECIFICATIONS-OTHERS			
Refrigerant circuit	Refrigerant type		R32
	Refrigerant charge		KG 1.45
	Refrigerant control		EXV
Piping connections (external diameter)	liquid	mm	Φ6.35
	gas	mm	Φ12.7
	drain	mm	Φ17
Heat insulation type		Both liquid and Gas pipes	
Max. piping Length		m	25
Max. Level Difference		m	15
Chargeless		m	10
Amount of Additional Charge of Refrigerant		g/m	20
International Protection degree		IP 24	

Note: the data are based on the conditions shown in the table below

cooling	heating	Piping length
Indoor: 27°CDB/19°CWB Outdoor: 35°CDB/24°CWB	Indoor:20°CDB Outdoor: 7°CDB/6°CWB	5m

Conversation formulae
Kcal/h= KW×860
Btu/h= KW×3414
cfm=m³/min×35.3

3. Sensors list

type	Description	Qty
Ambient sensor Defrosting sensor Discharging sensor	Its used for detecting temperature of outdoor side Its used for controlling outdoor defrosting at heating mode Its used for compressor in case of over-heat	3 in 1
Suction sensor	Its used for detecting suction pipe temperature of compressor to adjust gas flowing	1



4.Pinping diagrams

Cooling mode

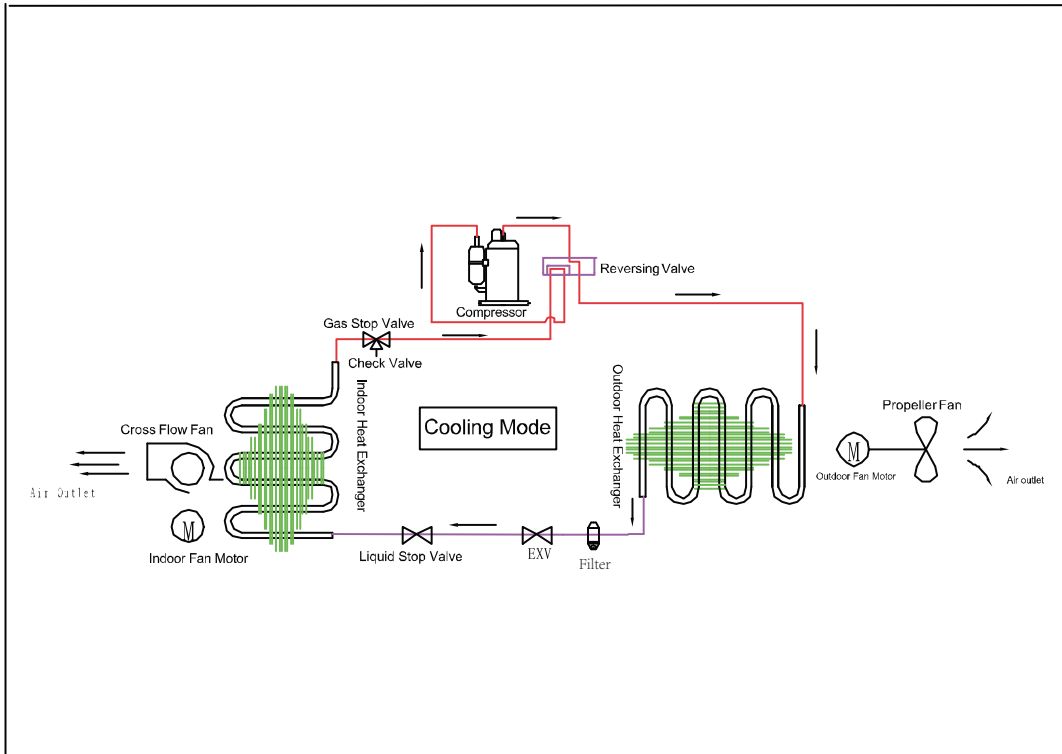

Heating mode

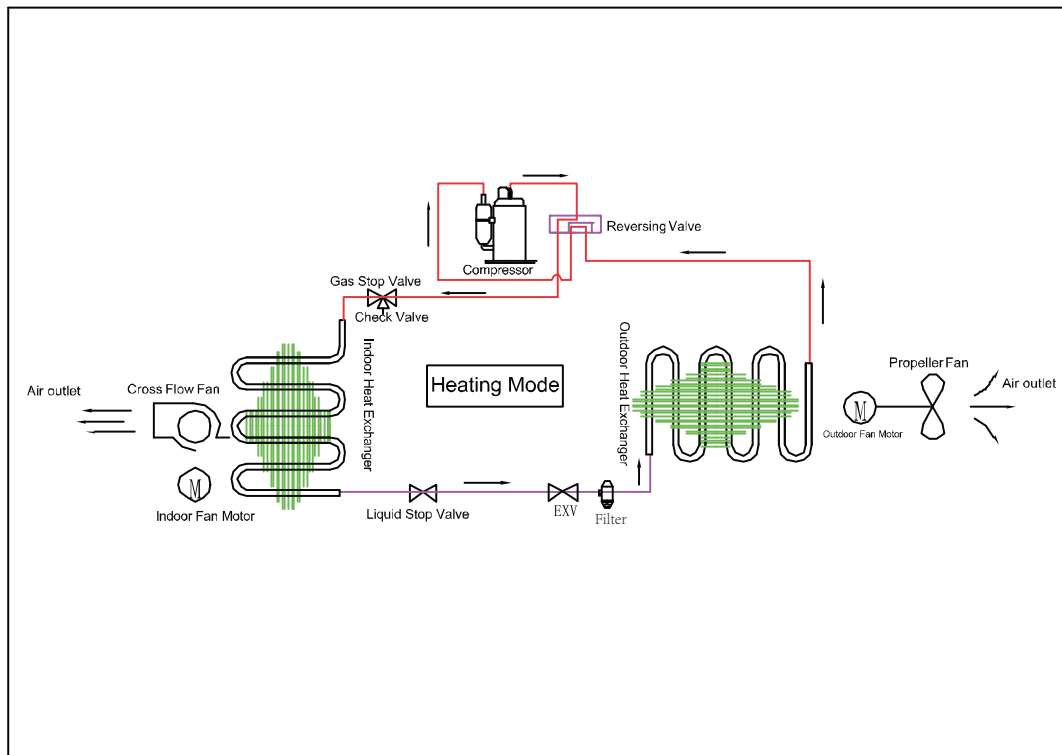

5. Operation range

The name of parts

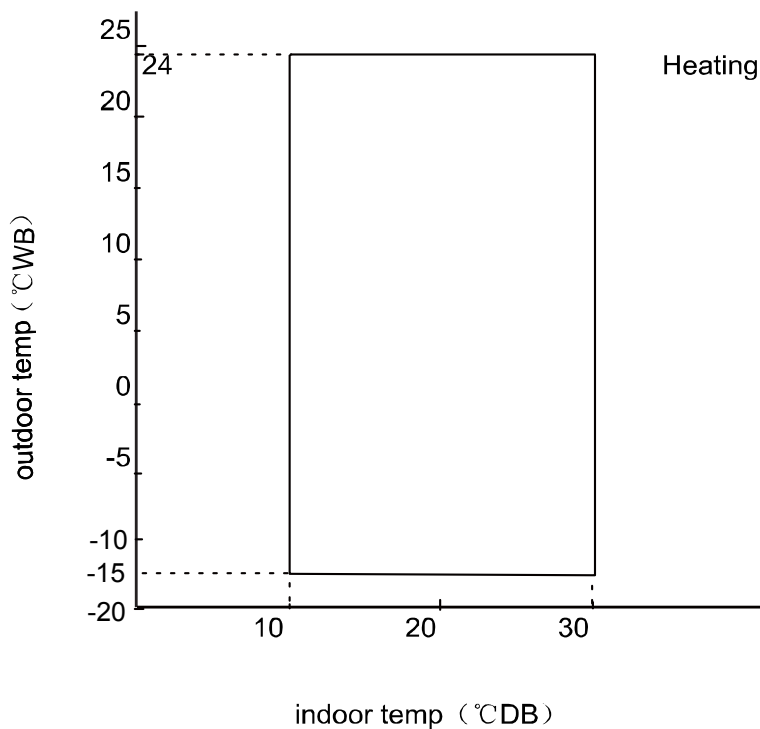
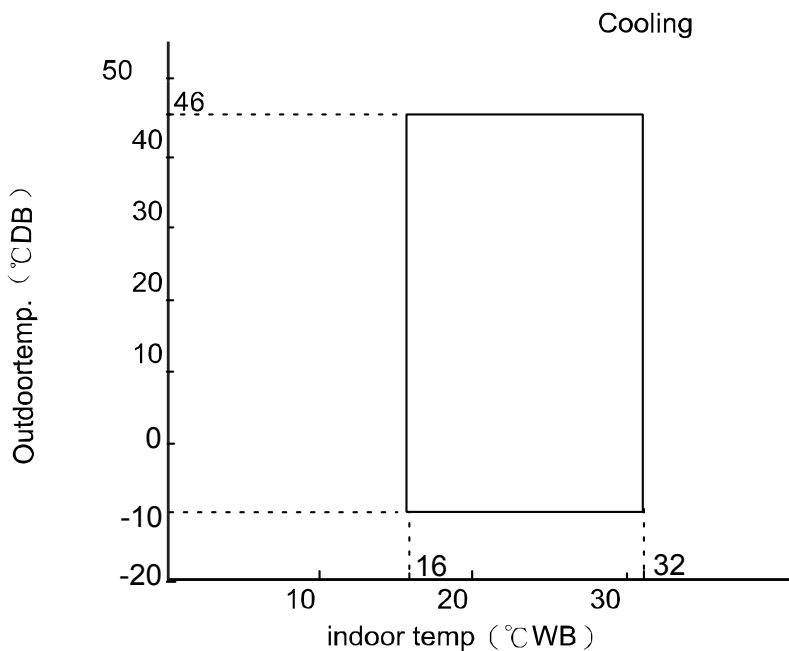

Notes:

The graphs are based on the following condition:

Equivalent piping length	5m
Level difference	0m
Air flow rate	high



6.PCB Diagram

Connectors

PCB (1) (Outdoor Control PCB)

- 1) CN1, CN2 Connector for power N and L
- 2) CN3 Connector for ground
- 3) CN23 Connector for DC POWER 15V and 5V to the module board
- 4) CN9, CN10 Connector for CN2, CN1 on the module board
- 5) CN22 Connector for fan motor
- 6) CN11 Connector for four way valve coil
- 7) CN17, CN47 Connector for thermistors
- 8) CN24 Connector for communicate between the control board and the module board
- 9) CN26, CN25 Connector to P and N of the module board
- 10) CN36 Connector for communicate between indoor and outdoor unit
- 11) CN15 Connector for electric expansion valves
- 12) CN50 Connector for DRED-control
- 13) CN45 Connector for heating- protect wire of terminal block

Other Designations

- 1) FUSE 1, (25A, 250VAC); FUSE 2(3.15A, 250VAC)
- 2) LED 1 Keep light representative normal, if keep flash interval representative trouble Alarm
- 3) RV1, RV2, RV3 Varistor

PCB (2) (Module PCB)

CN10 Connector for the DC power 5V and 15V form the control PCB
CN11 Connector for communicate between the control board and the module board
P (CN8), N (CN9) Connector for capacitance board
LI (CN3), LO (CN4) Connector for reactor
CN5, CN6, CN7 Connector for the U, V, W wire of the compressor

PCB (2)

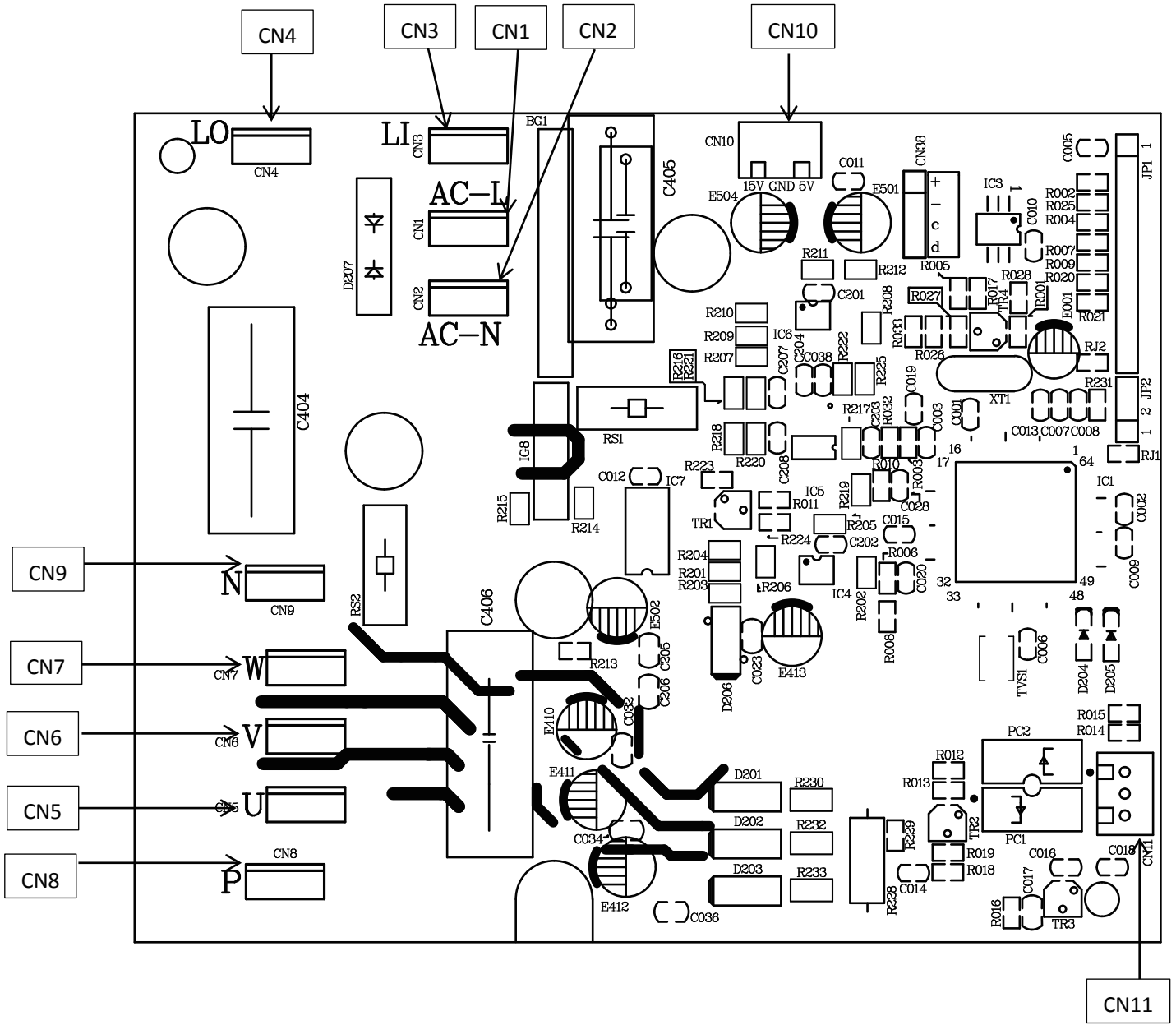

Wiring diagrams

OUTDOOR UNIT WIRING DIAGRAM

0010534175A

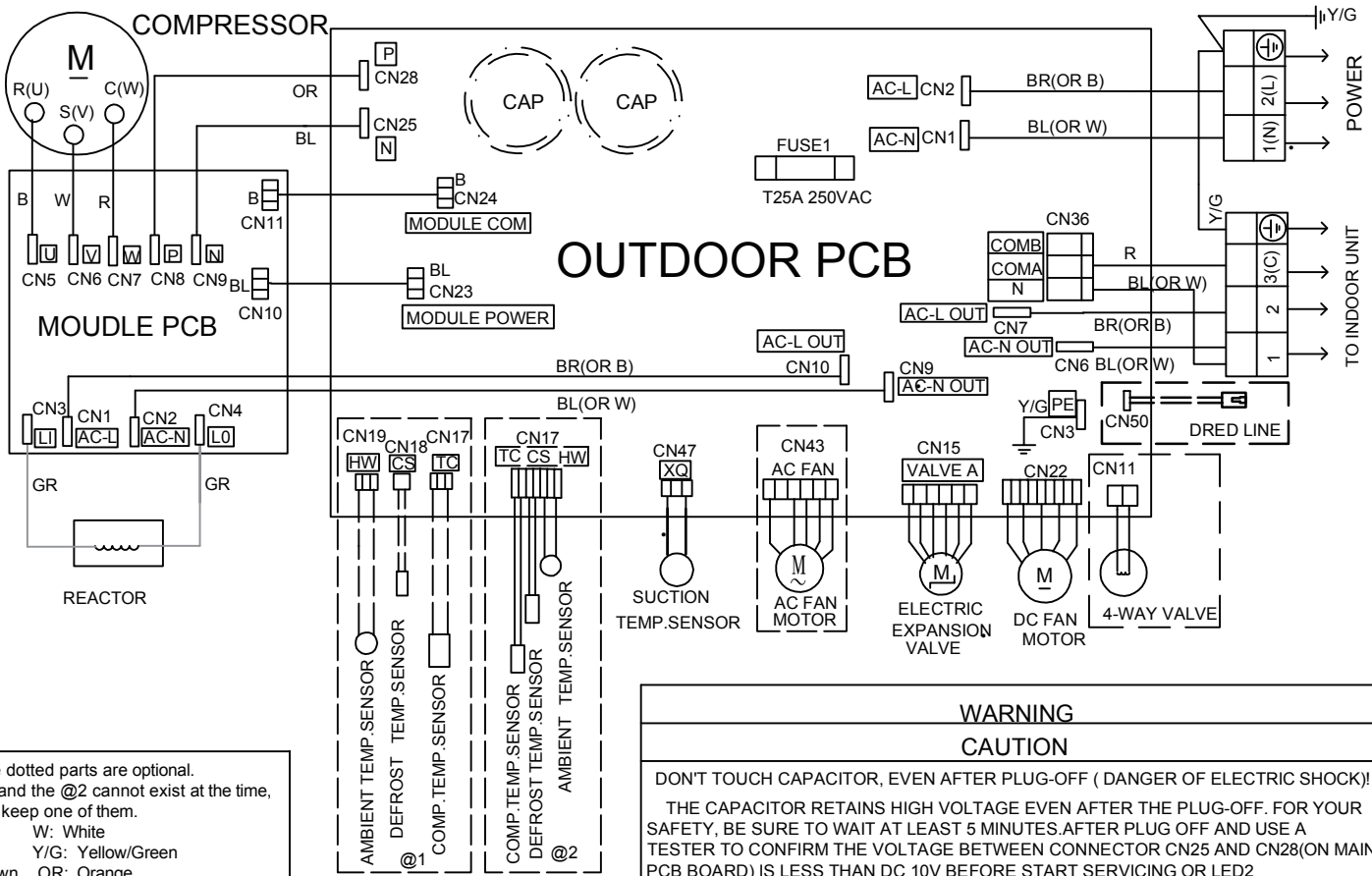

Note:The dotted parts are optional.
 The @1 and the @2 cannot exist at the time, but must keep one of them.
 B: Black W: White
 R: Red Y/G: Yellow/Green
 BR: Brown OR: Orange
 BL: Blue GR:Gray



7. Functions and Control

7.1 Main functions and control specification

7.1.1 The operation frequency of outdoor unit and its control

7.1.1.1 The operation frequency control of compressor

The operation frequency scope of compressor:

Mode	Minimum operation frequency	Maximum operation frequency
Heating	20Hz	118Hz
Refrigeration	20 Hz	90Hz

7.1.1.2 The starting of compressor

When the compressor is started for the first time, it must be kept under the conditions of 58Hz,88Hz for one minute (the overheating protection of the outdoor unit air-blowing temperature, immediately decrease the frequency when the compressor is overflowing and releasing the pressure), then it can be operated towards the target frequency. When the machine runs normally, there's no such process. After starting the compressor for operation, the compressor should run according to the calculated frequency, and every determined frequency for protection should be prior to the calculated frequency.

7.1.1.3 The speeds of increasing or decreasing the frequency of the compressor

The speed of increasing or decreasing the frequency rapidly 1 -----1HZ/second

The speed of increasing or decreasing the frequency slowly 2 -----1HZ/10seconds

7.1.1.4 The calculation of the compressor's frequency

1)、The minimum/maximum frequency limitation

A. While refrigerating: $F - MAX - r$ is the maximum operation frequency of the compressor; $F - MIN - r$ is the minimum operation frequency of the compressor.

B. While heating: $F - MAX - d$ is the maximum operation frequency of the compressor; $F - MIN - d$ is the minimum operation frequency of the compressor.

1)、The frequency limitation which is affected by the environment temperature.

Heating mode:

Serial No.	Temperature scope	Frequency limitation
1	Wh_c<-12	Max_hz8 117 HZ
2	Wh_c<-8	Max_hz7 117 HZ
3	Wh_c<-2	Max_hz4 117 HZ
4	Wh_c<5	Max_hz5 99 HZ
5	Wh_c<10	Max_hz1 90 HZ
6	Wh_c<17	Max_hz2 72 HZ
7	Wh_c<20	Max_hz2 62 HZ
8	Wh_c≥20	Max_hz6 45 HZ

Remarks: the above are the maximum frequency limitations of the complete appliance which are affected by the environment, and they have nothing to do with the ability of the indoor unit.

Refrigeration/dehumidification mode::

Serial No.	Temperature scope	Frequency limitation
1	Wh_c<16	Max_hz1 38 HZ
1	Wh_c<22	Max_hz1 44 HZ
1	Wh_c<28	Max_hz1 55 HZ

2	Wh_c<32	Max_hz2 74 HZ
3	Wh_c≥40	Max_hz3 90 HZ
4	Wh_c<48	Max_hz4 68 HZ
5	Wh_c≥48	Max_hz5 60 HZ

Remarks: the above are not only the maximum frequency limitations of the complete appliance which are affected by the environment, but also the maximum ability limitation of the system. When the starting ability is not the maximum, its maximum frequency limitation is calculated by the following equations:

The frequency limitation which is affected by the temperature and under the condition of actual ability=the actual running system ability*the maximum frequency which is limited by the temperature and under the condition of maximum ability/the maximum designing ability of the system

$$\Delta T = \frac{\sum (\Delta T_i \cdot P_i)}{\sum P_i} \quad (\Delta T_i = |T_{st_i} - T_{nh_i}| \text{ the indoor environment temperature}; P_i = i \text{ the ability of the indoor unit})$$

Refrigeration/dehumidification:

ΔT	<1	=1	=2	=3	≥4
The percentage of the rated frequency P	70%	80%	85%	90%	100%

Heating mode:

ΔT	<1	=1	=2	=3	≥4
The percentage of the rated frequency P	70%	80%	85%	90%	100%

$K = \sum K_i$ /the number of running machines

The indoor set airflow speed	Low	Medium	High	Strong	Quiet	Healthy airflow
The percentage of the rated frequency K_i	80%	90%	100%	110%	70%	65%

The calculation of the actual output frequency: when there is no healthy airflow: $F = F_{ED} \cdot P \cdot K$

When the healthy airflow has been set: $F = F_{ED} \cdot P \cdot K \cdot K(\text{airflow speed}) \cdot K(\text{healthy airflow})$

When refrigerating, it is needed to satisfy $F_{MIN-d} < F < F_{MAX-d}$

When heating, it is needed to satisfy $F_{MIN-r} < F < F_{MAX-r}$

7.1.2: The outdoor fan control (exchange fan)

When the fan is changed among every airflow speed (including stop blowing), in order to avoid the airflow speed from skipping frequently, it must be kept under each mode for over 30 seconds, and then it can be changed to another mode (when refrigerating, the time is changed to 15 seconds).

7.1.2.1: The outdoor fan control when refrigerating or dehumidifying



During the compressor is started for 3 seconds, the outdoor fan is controlled the airflow speed according to the temperature conditions of the outdoor environment.

Tao (°C)	Tao <22°C	22°C5 < Tao <29°C5	Tao ≥29°C5
Cool/Dry	Level 3	Level 5	Level 7
Tao (°C)	Tao <10°C	10°C < Tao <16°C	Tao ≥16°C
Heat	Level 7	Level 5	Level 3

After the compressor is started for 3 seconds, the outdoor fan is controlled the airflow speed according to the temperature conditions of the outdoor environment and frequency of compressor.

Frequency of cooling mode (Hz)	<51	51~70	≥70	
Tao (°C)	≤22	Level 3	Level 5	Level 6
	22~29	Level 4	Level 6	Level 7
	≥29	Level 7		

Frequency of heat mode (Hz)	<51	51~90	≥90	
Tao (°C)	≤10	Level 5	Level 7	Level 7
	10~16	Level 4	Level 5	Level 5
	>16	Level 2		

7.1.3: The control of the outdoor electronic expansion valve

When starting the compressor: the opening size of the valve must be guaranteed to have entered into the standard opening size, and then the compressor can be started.

When refrigeration is in vain (the machine is shut down or is in the state of retrograde operation), the opening size of the expansion valve of the indoor unit is 5 steps;

When heating is in vain, the opening size of the expansion valve of the indoor unit is 55 steps;

When the outdoor unit is shut down, the valve is opened completely for 2 minutes, and then begin initialization.

The scope of refrigeration valve 90----480 steps

The scope of heating valve 60----480 steps

The valves are adjusted according to the degree of superheat —SHa, △SHa.

7.1.4: Four way control

For the details of defrosting four-way valve control, see the defrosting process.

Four way working in other ways:

Under the mode of heating, open the four-way valve, when the compressor is not started or changed to non-heating mode, make sure the compressor is stopped for 2 minutes, and then close the four-way valve.

7.1.5 : Protection function

7.1.5.1: TTC high temperature-preventing protection

Once the machine is started, it can run TTC overheating protection of air-blowing, but air-blowing sensor malfunction must alarm after 4 minutes during which the compressor is started (during the course of self-detection, there's no such limitation)

Sensor detection methods: 100 times (one cycle of procedure run is one time, and about 5ms, detection method for each time: continuously sampling for 8 times, then order them and take the mean value of the middle 2 values), take the mean value.

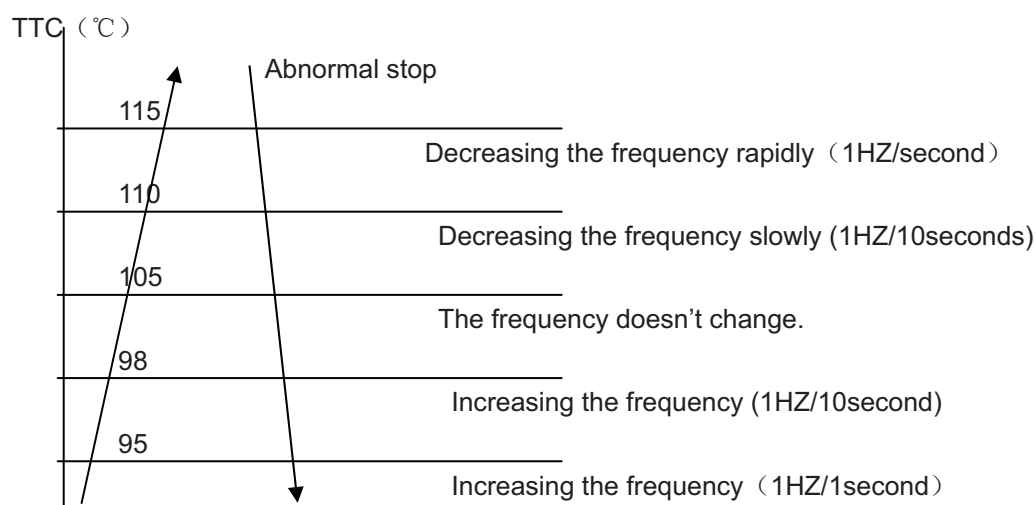

TTC \geq 115°C lasts for 20 seconds. Overheating protection of air-blowing, alarm malfunction to the indoor, others don't last.

7.1.5.2: TC high temperature-preventing control of the indoor heating unit

Tpg_indoor is the highest value of the effective indoor unit (start it and it is in accord with the running state). The indoor heat exchanger sensor tests the temperature of the indoor heat exchanger. If the temperature is higher than 48°C, decrease the rotate speed of the compressor and do the high temperature-preventing protection of the indoor heat exchanger; if the temperature of the indoor heat exchanger is lower than 45°C, recover to the normal control.

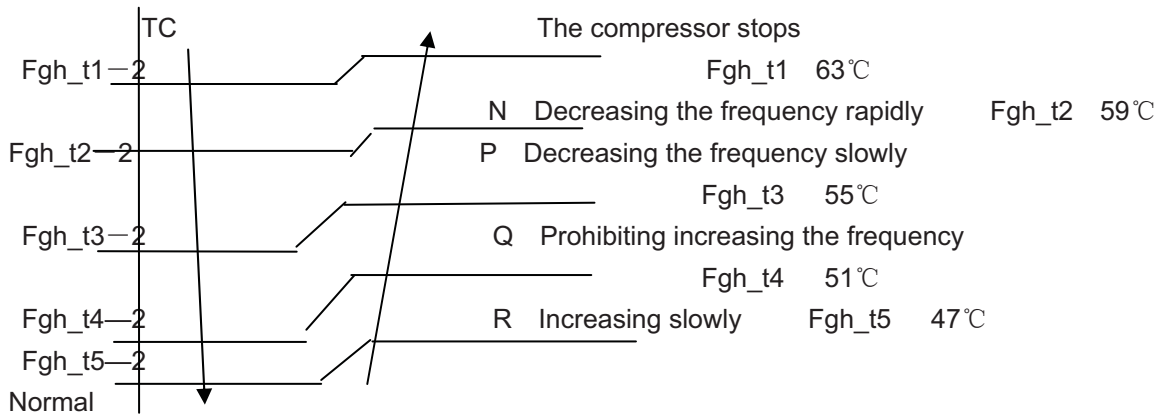

- N: Decreasing at the speed of 1HZ/1second
- P: Decreasing at the speed of 1Hz/10seconds
- Q: Continue to keep the last-time instruction cycle
- R: Increasing at the speed of 1Hz/10seconds

Remarks: the outdoor unit

7.1.5.3: The protection function of AC current:

During the starting process of the compressor, if the AC current is greater than 12A, the frequency of the compressor decreases at the speed of 1HZ/second.

During the starting process of the compressor, if the AC current is greater than 11A, the frequency of the compressor decreases at the speed of 0.1HZ/second.

During the starting process of the compressor, if the AC current is greater than 10A, the frequency of the compressor increases at the prohibited speed.

During the starting process of the compressor, if the AC current is greater than 9A, the frequency of the compressor increases at the speed of no faster than 0.1HZ/second.

Remarks: when the outdoor temperature is high, there's compensation for AC current protection.

(1)When the outdoor environment temperature is higher than 40°C, AC current protection value decreases by 1.5A

(2)When the outdoor environment temperature is higher than 50°C, AC current protection value decreases by 3.5A



7.1.5.4: Antifreezing protection of the indoor heat exchanger

When refrigerating/heating, prevent freezing.

Tpg_indoor is the minimum value of the effective indoor unit (start it and it is in accord with the running state).

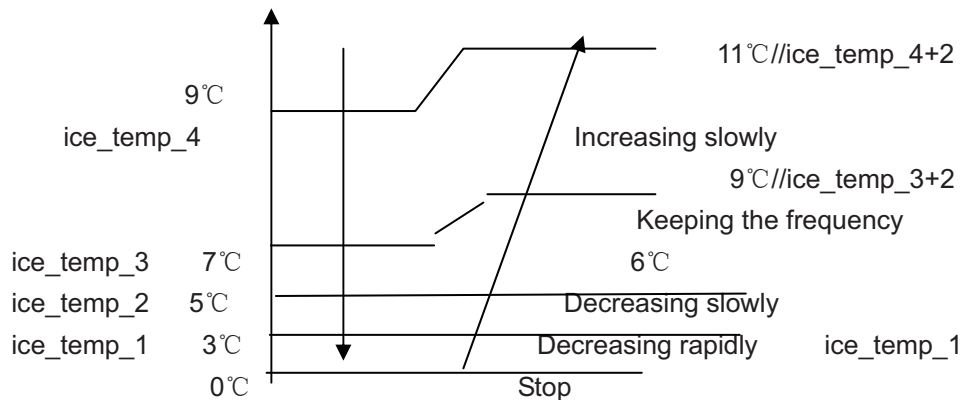

When $T_{pg_indoor} < ice_temp_1\ ^\circ C$, the frequency of the compressor decreases at the speed of 1HZ/1second.

When $T_{pg_indoor} < ice_temp_2\ ^\circ C$, the frequency of the compressor decreases at the speed of 1HZ/10seconds.

When T_{pg_indoor} begins to rise again, and $ice_temp_2 \leq T_{pg_indoor} \leq ice_temp_3\ ^\circ C$, the frequency of the compressor doesn't change.

When $ice_temp_3 < T_{pg_indoor} < ice_temp_4\ ^\circ C$, the frequency of the compressor increases at the speed of 1HZ/10seconds.

For example, $T_{pg_indoor} \leq 0\ ^\circ C$, last for 2 minutes, and then the outdoor unit will stop, and report underload malfunction, but don't send malfunction report to the indoor.

The compressor stops for more than 3 minutes, $T_{pg_indoor} > ice_temp_4\ ^\circ C$, the compressor recovers.

7.1.5.5: Temperature protection of the outdoor refrigerating coil

When the defrosting temperature and the sensor's temperature are higher than 68°C, the frequency of the compressor decreases 1hz/10seconds. Keep the frequency until it decreases to the lowest frequency. When the temperatures are lower than 68°C and higher than 61°C, keep the frequency of the compressor. When the temperatures are lower than 61°C, relieve the defrosting temperature protection.

7.2 Value of Thermistor

7.2.1 Outdoor Unit

Ambient Sensor, Defrosting Sensor, Pipe sensor

R25°C=10KΩ ± 3% B25°C/50°C=3700K ± 3%

Temp.(°C)	Max.(KΩ)	Normal(KΩ)	Min.(KΩ)	Tolerance(°C)	
-30	165.2170	147.9497	132.3678	-1.94	1.75
-29	155.5754	139.5600	125.0806	-1.93	1.74
-28	146.5609	131.7022	118.2434	-1.91	1.73
-27	138.1285	124.3392	111.8256	-1.89	1.71

-26	130.2371	117.4366	105.7989	-1.87	1.70
-25	122.8484	110.9627	100.1367	-1.85	1.69
-24	115.9272	104.8882	94.8149	-1.83	1.67
-23	109.4410	99.1858	89.8106	-1.81	1.66
-22	103.3598	93.8305	85.1031	-1.80	1.64
-21	97.6556	88.7989	80.6728	-1.78	1.63
-20	92.3028	84.0695	76.5017	-1.76	1.62
-19	87.2775	79.6222	72.5729	-1.74	1.60
-18	82.5577	75.4384	68.8710	-1.72	1.59
-17	78.1230	71.5010	65.3815	-1.70	1.57
-16	73.9543	67.7939	62.0907	-1.68	1.55
-15	70.0342	64.3023	58.9863	-1.66	1.54
-14	66.3463	61.0123	56.0565	-1.64	1.52
-13	62.8755	57.9110	53.2905	-1.62	1.51
-12	59.6076	54.9866	50.6781	-1.60	1.49
-11	56.5296	52.2278	48.2099	-1.58	1.47
-10	53.6294	49.6244	45.8771	-1.56	1.46
-9	50.8956	47.1666	43.6714	-1.54	1.44
-8	48.3178	44.8454	41.5851	-1.51	1.42
-7	45.8860	42.6525	39.6112	-1.49	1.40
-6	43.5912	40.5800	37.7429	-1.47	1.39
-5	41.4249	38.6207	35.9739	-1.45	1.37
-4	39.3792	36.7676	34.2983	-1.43	1.35
-3	37.4465	35.0144	32.7108	-1.41	1.33
-2	35.6202	33.3552	31.2062	-1.38	1.31
-1	33.8936	31.7844	29.7796	-1.36	1.29
0	32.2608	30.2968	28.4267	-1.34	1.28
1	30.7162	28.8875	27.1431	-1.32	1.26
2	29.2545	27.5519	25.9250	-1.29	1.24
3	27.8708	26.2858	24.7686	-1.27	1.22
4	26.5605	25.0851	23.6704	-1.25	1.20
5	25.3193	23.9462	22.6273	-1.23	1.18
6	24.1432	22.8656	21.6361	-1.20	1.16
7	23.0284	21.8398	20.6939	-1.18	1.14
8	21.9714	20.8659	19.7982	-1.15	1.12
9	20.9688	19.9409	18.9463	-1.13	1.09
10	20.0176	19.0621	18.1358	-1.11	1.07
11	19.1149	18.2270	17.3646	-1.08	1.05
12	18.2580	17.4331	16.6305	-1.06	1.03
13	17.4442	16.6782	15.9315	-1.03	1.01
14	16.6711	15.9601	15.2657	-1.01	0.99
15	15.9366	15.2770	14.6315	-0.98	0.96
16	15.2385	14.6268	14.0271	-0.96	0.94
17	14.5748	14.0079	13.4510	-0.93	0.92
18	13.9436	13.4185	12.9017	-0.91	0.90

19	13.3431	12.8572	12.3778	-0.88	0.87
20	12.7718	12.3223	11.8780	-0.86	0.85
21	12.2280	11.8126	11.4011	-0.83	0.83
22	11.7102	11.3267	10.9459	-0.81	0.80
23	11.2172	10.8634	10.5114	-0.78	0.78
24	10.7475	10.4216	10.0964	-0.75	0.75
25	10.3000	10.0000	9.7000	-0.75	0.75
26	9.8975	9.5974	9.2980	-0.76	0.76
27	9.5129	9.2132	8.9148	-0.80	0.80
28	9.1454	8.8465	8.5496	-0.84	0.83
29	8.7942	8.4964	8.2013	-0.87	0.86
30	8.4583	8.1621	7.8691	-0.91	0.90
31	8.1371	7.8428	7.5522	-0.95	0.93
32	7.8299	7.5377	7.2498	-0.98	0.97
33	7.5359	7.2461	6.9611	-1.02	1.00
34	7.2546	6.9673	6.6854	-1.06	1.04
35	6.9852	6.7008	6.4222	-1.10	1.07
36	6.7273	6.4459	6.1707	-1.13	1.11
37	6.4803	6.2021	5.9304	-1.17	1.14
38	6.2437	5.9687	5.7007	-1.21	1.18
39	6.0170	5.7454	5.4812	-1.25	1.22
40	5.7997	5.5316	5.2712	-1.29	1.25
41	5.5914	5.3269	5.0704	-1.33	1.29
42	5.3916	5.1308	4.8783	-1.37	1.33
43	5.2001	4.9430	4.6944	-1.41	1.36
44	5.0163	4.7630	4.5185	-1.45	1.40
45	4.8400	4.5905	4.3500	-1.49	1.44
46	4.6708	4.4252	4.1887	-1.53	1.47
47	4.5083	4.2666	4.0342	-1.57	1.51
48	4.3524	4.1145	3.8862	-1.61	1.55
49	4.2026	3.9686	3.7443	-1.65	1.59
50	4.0588	3.8287	3.6084	-1.70	1.62
51	3.9206	3.6943	3.4780	-1.74	1.66
52	3.7878	3.5654	3.3531	-1.78	1.70
53	3.6601	3.4416	3.2332	-1.82	1.74
54	3.5374	3.3227	3.1183	-1.87	1.78
55	3.4195	3.2085	3.0079	-1.91	1.82
56	3.3060	3.0989	2.9021	-1.95	1.85
57	3.1969	2.9935	2.8005	-2.00	1.89
58	3.0919	2.8922	2.7029	-2.04	1.93
59	2.9909	2.7948	2.6092	-2.08	1.97
60	2.8936	2.7012	2.5193	-2.13	2.01
61	2.8000	2.6112	2.4328	-2.17	2.05
62	2.7099	2.5246	2.3498	-2.22	2.09
63	2.6232	2.4413	2.2700	-2.26	2.13

64	2.5396	2.3611	2.1932	-2.31	2.17
65	2.4591	2.2840	2.1195	-2.36	2.21
66	2.3815	2.2098	2.0486	-2.40	2.25
67	2.3068	2.1383	1.9803	-2.45	2.29
68	2.2347	2.0695	1.9147	-2.49	2.34
69	2.1652	2.0032	1.8516	-2.54	2.38
70	2.0983	1.9393	1.7908	-2.59	2.42
71	2.0337	1.8778	1.7324	-2.63	2.46
72	1.9714	1.8186	1.6761	-2.68	2.50
73	1.9113	1.7614	1.6219	-2.73	2.54
74	1.8533	1.7064	1.5697	-2.78	2.58
75	1.7974	1.6533	1.5194	-2.83	2.63
76	1.7434	1.6021	1.4710	-2.88	2.67
77	1.6913	1.5528	1.4243	-2.92	2.71
78	1.6409	1.5051	1.3794	-2.97	2.75
79	1.5923	1.4592	1.3360	-3.02	2.80
80	1.5454	1.4149	1.2942	-3.07	2.84
81	1.5000	1.3721	1.2540	-3.12	2.88
82	1.4562	1.3308	1.2151	-3.17	2.93
83	1.4139	1.2910	1.1776	-3.22	2.97
84	1.3730	1.2525	1.1415	-3.27	3.01
85	1.3335	1.2153	1.1066	-3.32	3.06
86	1.2953	1.1794	1.0730	-3.38	3.10
87	1.2583	1.1448	1.0405	-3.43	3.15
88	1.2226	1.1113	1.0092	-3.48	3.19
89	1.1880	1.0789	0.9789	-3.53	3.24
90	1.1546	1.0476	0.9497	-3.58	3.28
91	1.1223	1.0174	0.9215	-3.64	3.33
92	1.0910	0.9882	0.8942	-3.69	3.37
93	1.0607	0.9599	0.8679	-3.74	3.42
94	1.0314	0.9326	0.8424	-3.80	3.46
95	1.0030	0.9061	0.8179	-3.85	3.51
96	0.9756	0.8806	0.7941	-3.90	3.55
97	0.9490	0.8558	0.7711	-3.96	3.60
98	0.9232	0.8319	0.7489	-4.01	3.64
99	0.8983	0.8088	0.7275	-4.07	3.69
100	0.8741	0.7863	0.7067	-4.12	3.74
101	0.8507	0.7646	0.6867	-4.18	3.78
102	0.8281	0.7436	0.6672	-4.23	3.83
103	0.8061	0.7233	0.6484	-4.29	3.88
104	0.7848	0.7036	0.6303	-4.34	3.92
105	0.7641	0.6845	0.6127	-4.40	3.97
106	0.7441	0.6661	0.5957	-4.46	4.02
107	0.7247	0.6482	0.5792	-4.51	4.07
108	0.7059	0.6308	0.5632	-4.57	4.12

109	0.6877	0.6140	0.5478	-4.63	4.16
110	0.6700	0.5977	0.5328	-4.69	4.21
111	0.6528	0.5820	0.5183	-4.74	4.26
112	0.6361	0.5667	0.5043	-4.80	4.31
113	0.6200	0.5518	0.4907	-4.86	4.36
114	0.6043	0.5374	0.4775	-4.92	4.41
115	0.5891	0.5235	0.4648	-4.98	4.45
116	0.5743	0.5100	0.4524	-5.04	4.50
117	0.5600	0.4968	0.4404	-5.10	4.55
118	0.5460	0.4841	0.4288	-5.16	4.60
119	0.5325	0.4717	0.4175	-5.22	4.65
120	0.5194	0.4597	0.4066	-5.28	4.70

Discharging Sensor

R80°C=50KΩ ± 3%

B25/80°C=4450K ± 3%

Temp.((°C))	Max.(KΩ)	Normal(KΩ)	Min.(KΩ)	Tolerance(°C)	
-30	14646.0505	12061.7438	9924.4999	-2.96	2.45
-29	13654.1707	11267.8730	9290.2526	-2.95	2.44
-28	12735.8378	10531.3695	8700.6388	-2.93	2.44
-27	11885.1336	9847.7240	8152.2338	-2.92	2.43
-26	11096.6531	9212.8101	7641.8972	-2.91	2.42
-25	10365.4565	8622.8491	7166.7474	-2.90	2.42
-24	9687.0270	8074.3787	6724.1389	-2.88	2.41
-23	9057.2314	7564.2244	6311.6413	-2.87	2.41
-22	8472.2852	7089.4741	5927.0206	-2.86	2.40
-21	7928.7217	6647.4547	5568.2222	-2.84	2.39
-20	7423.3626	6235.7109	5233.3554	-2.83	2.39
-19	6953.2930	5851.9864	4920.6791	-2.82	2.38
-18	6515.8375	5494.2064	4628.5894	-2.80	2.37
-17	6108.5393	5160.4621	4355.6078	-2.79	2.37
-16	5729.1413	4848.9963	4100.3708	-2.77	2.36
-15	5375.5683	4558.1906	3861.6201	-2.76	2.35
-14	5045.9114	4286.5535	3638.1938	-2.75	2.34
-13	4738.4141	4032.7098	3429.0191	-2.73	2.34
-12	4451.4586	3795.3910	3233.1039	-2.72	2.33
-11	4183.5548	3573.4260	3049.5312	-2.70	2.32
-10	3933.3289	3365.7336	2877.4527	-2.69	2.31
-9	3699.5139	3171.3148	2716.0828	-2.67	2.30
-8	3480.9407	2989.2460	2564.6945	-2.66	2.29
-7	3276.5302	2818.6731	2422.6139	-2.64	2.28
-6	3085.2854	2658.8058	2289.2164	-2.63	2.28
-5	2906.2851	2508.9126	2163.9230	-2.61	2.27
-4	2738.6777	2368.3158	2046.1961	-2.60	2.26
-3	2581.6752	2236.3876	1935.5371	-2.58	2.25

-2	2434.5487	2112.5459	1831.4826	-2.56	2.24
-1	2296.6230	1996.2509	1733.6024	-2.55	2.23
0	2167.2730	1887.0018	1641.4966	-2.53	2.22
1	2045.9191	1784.3336	1554.7931	-2.52	2.21
2	1932.0242	1687.8144	1473.1460	-2.50	2.20
3	1825.0899	1597.0431	1396.2333	-2.48	2.19
4	1724.6540	1511.6468	1323.7551	-2.47	2.17
5	1630.2870	1431.2787	1255.4324	-2.45	2.16
6	1541.5904	1355.6163	1191.0048	-2.43	2.15
7	1458.1938	1284.3593	1130.2298	-2.41	2.14
8	1379.7528	1217.2282	1072.8813	-2.40	2.13
9	1305.9472	1153.9626	1018.7481	-2.38	2.12
10	1236.4792	1094.3200	967.6334	-2.36	2.11
11	1171.0715	1038.0743	919.3533	-2.35	2.09
12	1109.4661	985.0146	873.7359	-2.33	2.08
13	1051.4226	934.9440	830.6210	-2.31	2.07
14	996.7169	887.6792	789.8583	-2.29	2.06
15	945.1404	843.0486	751.3077	-2.27	2.04
16	896.4981	800.8922	714.8380	-2.26	2.03
17	850.6086	761.0603	680.3265	-2.24	2.02
18	807.3024	723.4134	647.6580	-2.22	2.00
19	766.4212	687.8205	616.7252	-2.20	1.99
20	727.8172	654.1596	587.4271	-2.18	1.98
21	691.3524	622.3161	559.6694	-2.16	1.96
22	656.8979	592.1831	533.3634	-2.14	1.95
23	624.3328	563.6604	508.4261	-2.12	1.93
24	593.5446	536.6540	484.7796	-2.10	1.92
25	564.4275	511.0760	462.3510	-2.09	1.90
26	536.9865	486.9352	441.1516	-2.07	1.89
27	511.0105	464.0500	421.0258	-2.05	1.87
28	486.4151	442.3499	401.9146	-2.03	1.86
29	463.1208	421.7683	383.7626	-2.01	1.84
30	441.0535	402.2430	366.5175	-1.99	1.83
31	420.1431	383.7151	350.1301	-1.97	1.81
32	400.3242	366.1295	334.5542	-1.95	1.80
33	381.5350	349.4341	319.7460	-1.93	1.78
34	363.7176	333.5801	305.6645	-1.90	1.76
35	346.8176	318.5216	292.2709	-1.88	1.75
36	330.7839	304.2151	279.5286	-1.86	1.73
37	315.5682	290.6199	267.4031	-1.84	1.71
38	301.1254	277.6976	255.8620	-1.82	1.70
39	287.4128	265.4119	244.8745	-1.80	1.68
40	274.3905	253.7288	234.4118	-1.78	1.66
41	262.0206	242.6161	224.4465	-1.76	1.64
42	250.2676	232.0436	214.9529	-1.74	1.63

43	239.0983	221.9825	205.9065	-1.71	1.61
44	228.4809	212.4060	197.2844	-1.69	1.59
45	218.3860	203.2887	189.0648	-1.67	1.57
46	208.7855	194.6066	181.2273	-1.65	1.55
47	199.6531	186.3369	173.7524	-1.63	1.54
48	190.9639	178.4584	166.6217	-1.60	1.52
49	182.6945	170.9508	159.8181	-1.58	1.50
50	174.8228	163.7951	153.3249	-1.56	1.48
51	167.3280	156.9733	147.1268	-1.53	1.46
52	160.1904	150.4683	141.2090	-1.51	1.44
53	153.3914	144.2641	135.5577	-1.49	1.42
54	146.9136	138.3454	130.1598	-1.47	1.40
55	140.7403	132.6980	125.0027	-1.44	1.38
56	134.8559	127.3081	120.0746	-1.42	1.36
57	129.2457	122.1630	115.3645	-1.40	1.34
58	123.8956	117.2504	110.8618	-1.37	1.32
59	118.7926	112.5589	106.5564	-1.35	1.30
60	113.9241	108.0776	102.4388	-1.32	1.28
61	109.2784	103.7961	98.5000	-1.30	1.26
62	104.8443	99.7046	94.7315	-1.28	1.23
63	100.6112	95.7939	91.1253	-1.25	1.21
64	96.5692	92.0553	87.6735	-1.23	1.19
65	92.7088	88.4805	84.3690	-1.20	1.17
66	89.0211	85.0614	81.2048	-1.18	1.15
67	85.4976	81.7908	78.1744	-1.15	1.12
68	82.1303	78.6615	75.2715	-1.13	1.10
69	78.9116	75.6668	72.4902	-1.10	1.08
70	75.8343	72.8004	69.8249	-1.08	1.06
71	72.8916	70.0561	67.2703	-1.05	1.03
72	70.0770	67.4283	64.8213	-1.03	1.01
73	67.3844	64.9115	62.4731	-1.00	0.99
74	64.8080	62.5006	60.2211	-0.98	0.96
75	62.3423	60.1906	58.0609	-0.95	0.94
76	59.9821	57.9770	55.9885	-0.92	0.92
77	57.7223	55.8552	53.9998	-0.90	0.89
78	55.5583	53.8210	52.0912	-0.87	0.87
79	53.4856	51.8706	50.2591	-0.85	0.84
80	51.5000	50.0000	48.5000	-0.85	0.84
81	49.7063	48.2057	46.7083	-0.85	0.85
82	47.9835	46.4842	44.9911	-0.89	0.89
83	46.3286	44.8323	43.3452	-0.93	0.92
84	44.7385	43.2468	41.7672	-0.96	0.95
85	43.2105	41.7248	40.2540	-1.00	0.99
86	41.7386	40.2604	38.7996	-1.03	1.02
87	40.3241	38.8545	37.4048	-1.07	1.06

88	38.9643	37.5045	36.0668	-1.11	1.09
89	37.6569	36.2078	34.7831	-1.14	1.13
90	36.3996	34.9622	33.5513	-1.18	1.16
91	35.1903	33.7653	32.3689	-1.22	1.19
92	34.0269	32.6151	31.2338	-1.26	1.23
93	32.9075	31.5096	30.1438	-1.30	1.27
94	31.8302	30.4467	29.0970	-1.33	1.30
95	30.7933	29.4246	28.0915	-1.37	1.34
96	29.7950	28.4417	27.1254	-1.41	1.37
97	28.8337	27.4961	26.1970	-1.45	1.41
98	27.9078	26.5864	25.3048	-1.49	1.44
99	27.0160	25.7110	24.4470	-1.53	1.48
100	26.1569	24.8685	23.6222	-1.57	1.52
101	25.3290	24.0574	22.8291	-1.61	1.55
102	24.5311	23.2765	22.0662	-1.65	1.59
103	23.7620	22.5245	21.3323	-1.69	1.63
104	23.0205	21.8002	20.6261	-1.73	1.66
105	22.3055	21.1025	19.9465	-1.77	1.70
106	21.6159	20.4303	19.2924	-1.81	1.74
107	20.9508	19.7825	18.6626	-1.85	1.77
108	20.3091	19.1582	18.0563	-1.89	1.81
109	19.6899	18.5564	17.4723	-1.93	1.85
110	19.0924	17.9761	16.9098	-1.98	1.89
111	18.5157	17.4166	16.3680	-2.02	1.93
112	17.9590	16.8769	15.8458	-2.06	1.96
113	17.4214	16.3564	15.3427	-2.10	2.00
114	16.9023	15.8542	14.8577	-2.15	2.04
115	16.4010	15.3696	14.3902	-2.19	2.08
116	15.9167	14.9020	13.9394	-2.23	2.12
117	15.4489	14.4506	13.5047	-2.27	2.16
118	14.9968	14.0149	13.0855	-2.32	2.19
119	14.5599	13.5942	12.6811	-2.36	2.23
120	14.1376	13.1879	12.2909	-2.41	2.27
121	13.7294	12.7955	11.9144	-2.45	2.31
122	13.3347	12.4165	11.5510	-2.50	2.35
123	12.9531	12.0503	11.2003	-2.54	2.39
124	12.5840	11.6965	10.8617	-2.58	2.43
125	12.2270	11.3545	10.5348	-2.63	2.47
126	11.8817	11.0240	10.2191	-2.68	2.51
127	11.5475	10.7046	9.9142	-2.72	2.55
128	11.2242	10.3957	9.6197	-2.77	2.59
129	10.9112	10.0970	9.3352	-2.81	2.63
130	10.6084	9.8082	9.0602	-2.86	2.67
131	10.3151	9.5288	8.7945	-2.91	2.71
132	10.0312	9.2586	8.5378	-2.95	2.75

133	9.7563	8.9971	8.2895	-3.00	2.80
134	9.4901	8.7441	8.0495	-3.05	2.84
135	9.2322	8.4993	7.8175	-3.09	2.88
136	8.9824	8.2623	7.5931	-3.14	2.92
137	8.7404	8.0329	7.3760	-3.19	2.96
138	8.5059	7.8108	7.1660	-3.24	3.00
139	8.2787	7.5958	6.9629	-3.29	3.04
140	8.0584	7.3875	6.7664	-3.33	3.09

8. Dimensional drawings

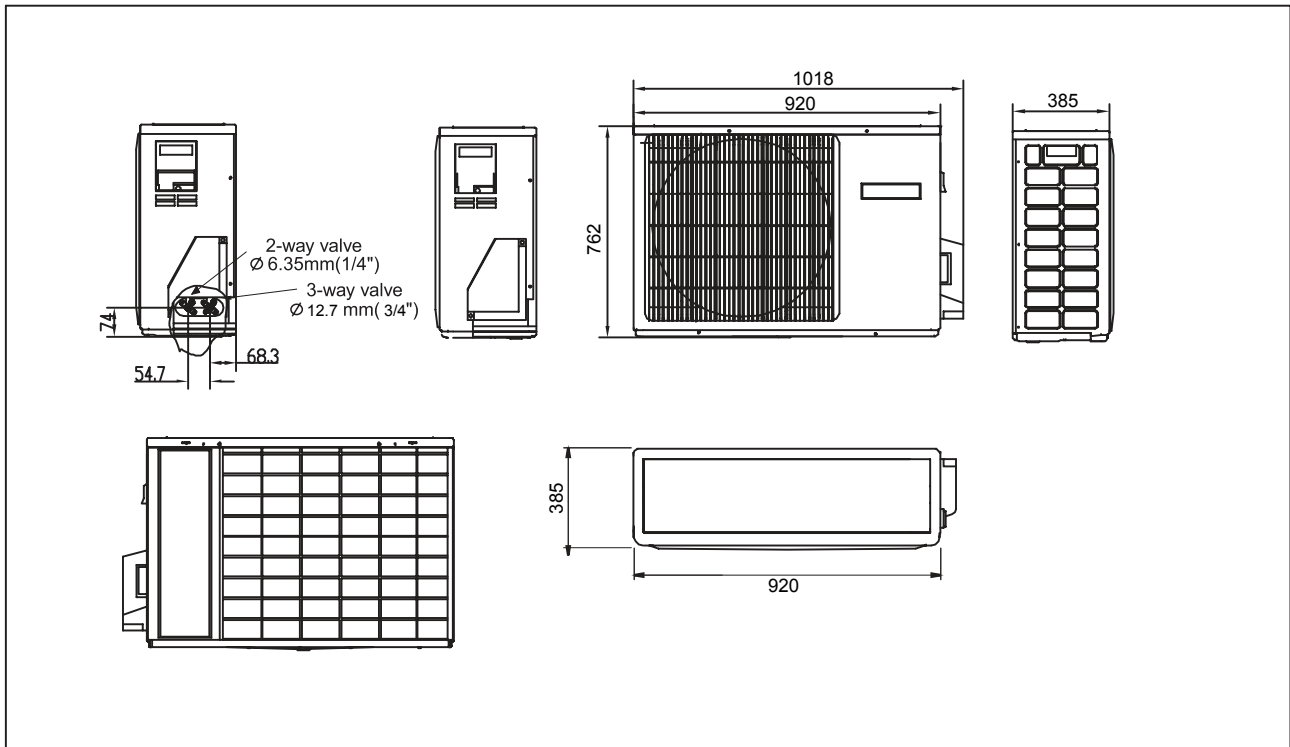

9. Center of gravity

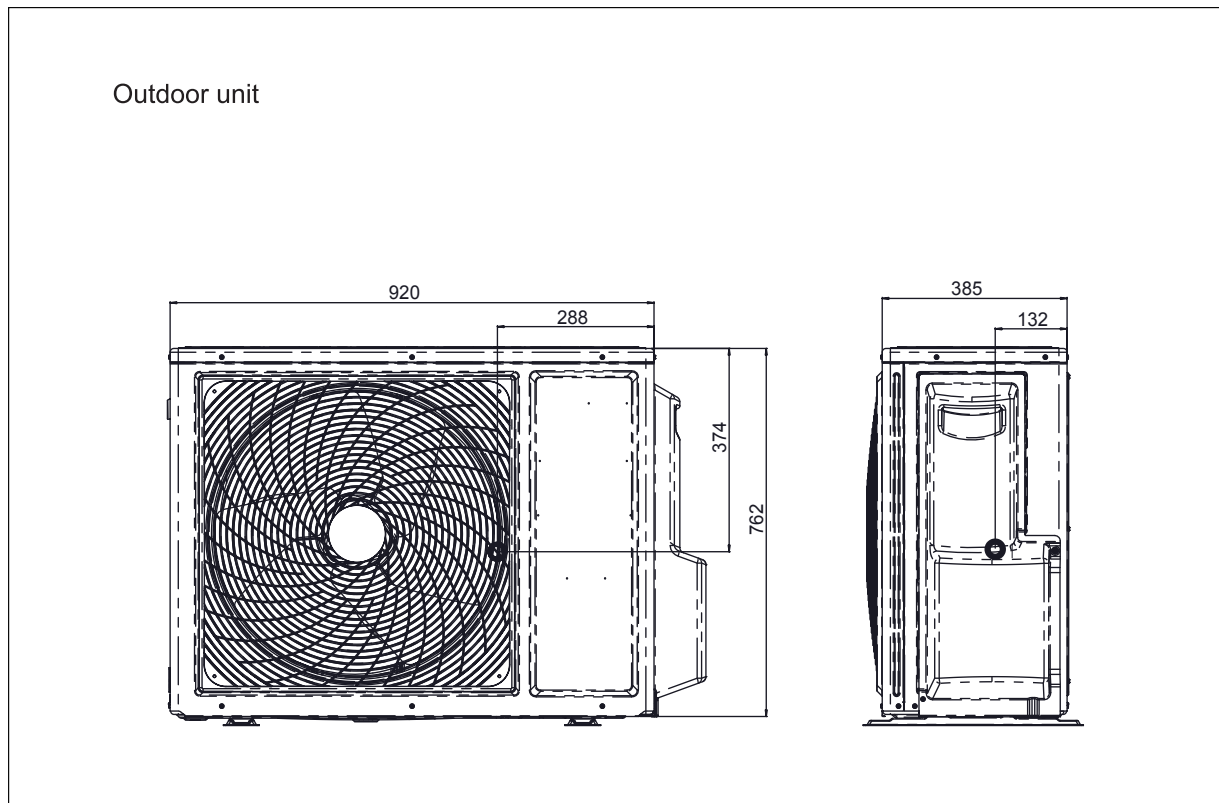

10. Service Diagnosis

10.1.1 Caution for Diagnosis

The operation lamp flashes when any of the following errors is detected.

1. When a protection device of the indoor or outdoor unit is activated or when the thermistor malfunctions, disabling equipment operation.
2. When a signal transmission error occurs between the indoor and outdoor units. In either case, conduct the diagnostic procedure described in the following pages.

10.1.2 Problem Symptoms and Measures

Symptom	Check Item	Details of Measure
None of the units operates	Check the power supply.	Check to make sure that the rated voltage is supplied.
	Check the indoor PCB	Check to make sure that the indoor PCB is broken
Operation sometimes stops.	Check the power supply.	A power failure of 2 to 10 cycles can stop air conditioner operation.
Equipment operates but does not cool, or does not heat (only for heat pump)	Check for faulty operation of the electronic expansion valve.	Set the units to cooling operation, and compare the temperatures of the liquid side connection pipes of the connection section among rooms to check the opening and closing operation of the electronic expansion valves of the individual units.
	Diagnosis by service port pressure and operating current.	Check for insufficient gas.
Large operating noise and vibrations	Check the installation condition.	Check to make sure that the required spaces for installation (specified in the Technical Guide, etc.) are provided.

10.2 Parameter of primary electronic appliance

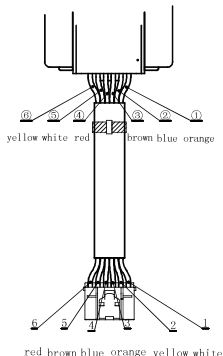
NO	Name	Parameter	Picture
1	ELECTRIC EXPANSION VALVE	Rated voltage: 12V Valve orifice : $\Phi 1.8\text{mm}$ Coil resistance $46 \pm 3.7 \Omega$	



10.3 Error Codes and Description indoor display

	Code indication			fault description
	Indoor displaying panel code indication		Outdoor (LED1 flash times)	
	Other display	Only For 498 and 498A display (Red/Green Time Run □On ★ Flash ■Off ,)		
Indoor and Outdoor	E7	■ ■★	15	Communication fault between indoor and outdoor units
Indoor Malfunction	E1	★ ■■	--	Room temperature sensor failure
	E2	★ □□	--	Heat-exchange sensor failure
	E4	★ □★	--	Indoor EEPROM error
	E14	■ □★	--	Indoor fan motor malfunction
Outdoor Malfunction	F12	■ ★ ■	1	Outdoor EEPROM error
	F1	□ ★ ★	2	The protection of IPM
	F22	★ ★ ■	3	Overcurrent protection of AC electricity for the outdoor model
	F3	■ ★ ■	4	Communication fault between the IPM and outdoor PCB
	F20	/	5	Compressor overload
	F19	■ ★ □	6	Power voltage is too high or low
	F27	/	7	Compressor blocked
	F4	■ ★ ■	8	Overheat protection for Discharge temperature
	F8	/	9	Outdoor DC fan motor fault
	F21	□ □★	10	Defrost temperature sensor failure
	F7	■ ★ ■	11	Suction temperature sensor failure
	F6	□ ★ ■	12	Ambient temperature sensor failure
	F25	★ □■	13	Discharge temperature sensor failure
	F30		14	Suction temp of compressor is too high
	F13		16	Less gas charge
	F14		17	4-way-valve fault
	F11	■ ★ ■	18	deviate from the normal for the compressor
	F28	■ ★ ■	19	Loop of the station detect error
	F2	■ ★ □	24	Overcurrent of the compressor
	F23	■ ★ □	25	Overcurrent protection for single-phase of the compressor

10.3.1 Thermistor or Related Abnormality

Indoor display E1: Room temperature sensor failure
E2: Indoor pipe sensor failure

outdoor display LED1 flash 10 times: Defrost temperature sensor failure
LED1 flash 11 times: Suction temperature sensor failure
LED1 flash 12 times: Ambient temperature sensor failure
LED1 flash 13 times: Discharge temperature sensor failure

Spare parts:
Sensors

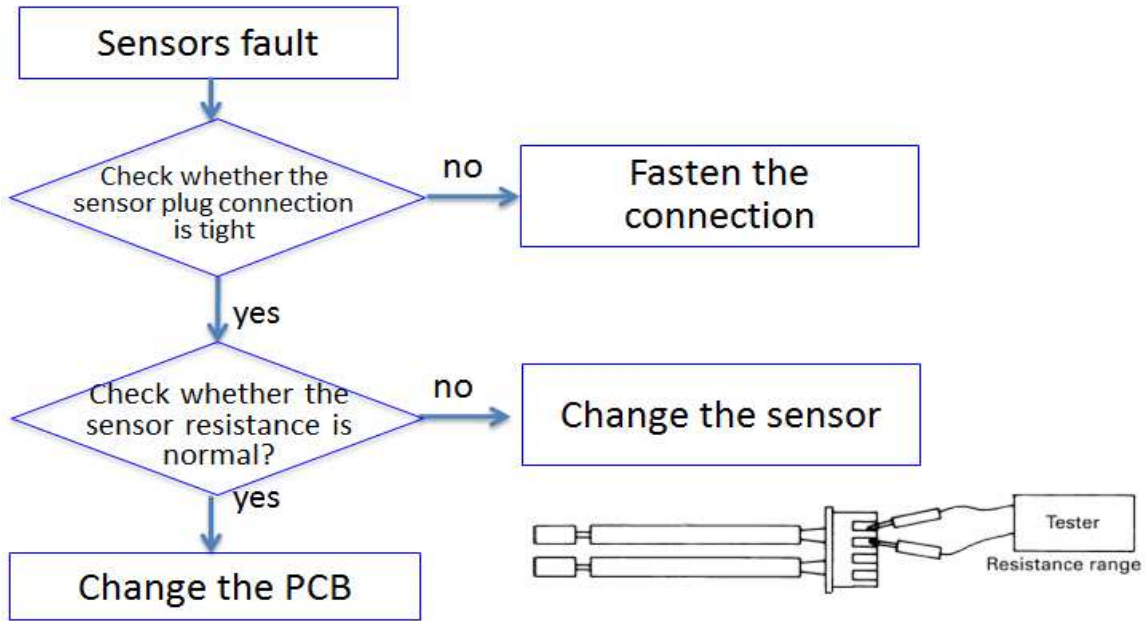

10.3.2 EEPROM abnormal

Indoor Display E4: indoor EEPROM error
 Outdoor display F12: Outdoor EEPROM error; Outdoor LED1 flash 1 times

Spare parts:
 Indoor PCB
 Outdoor PCB

Replace the indoor or outdoor PCB

10.3.3 Indoor AC fan motor malfunction

Indoor display E14
 This is caused by indoor motor or indoor PCB fault

Spare parts:
 Indoor PCB
 Indoor motor

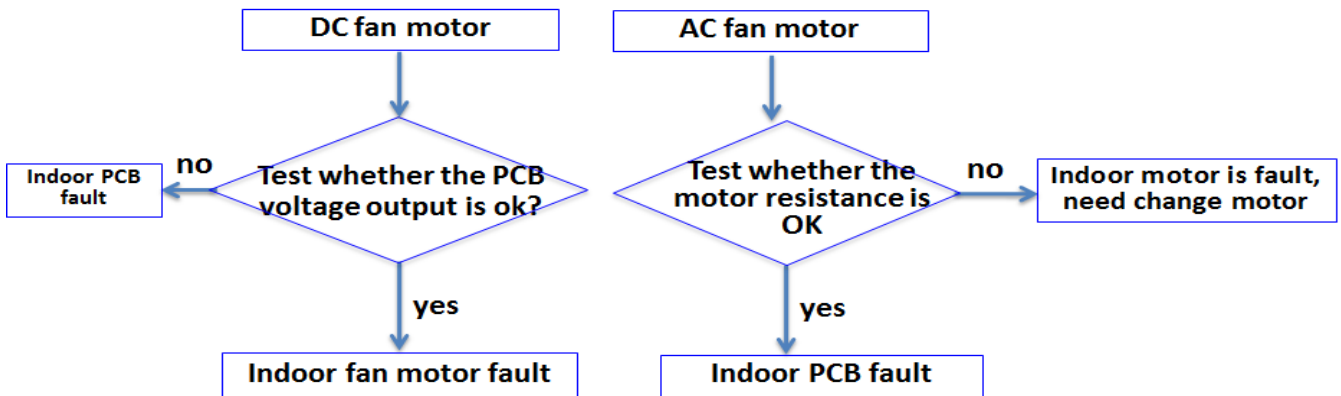

10.3.4 Outdoor DC fan motor fault

Outdoor display F8 LED1 flash 9 times

**Spare parts:
outdoor PCB
outdoor
motor**

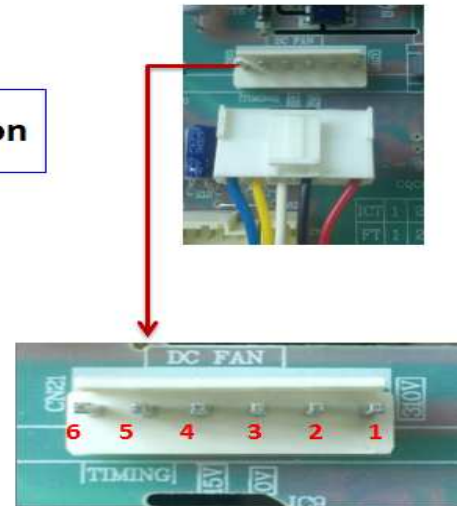
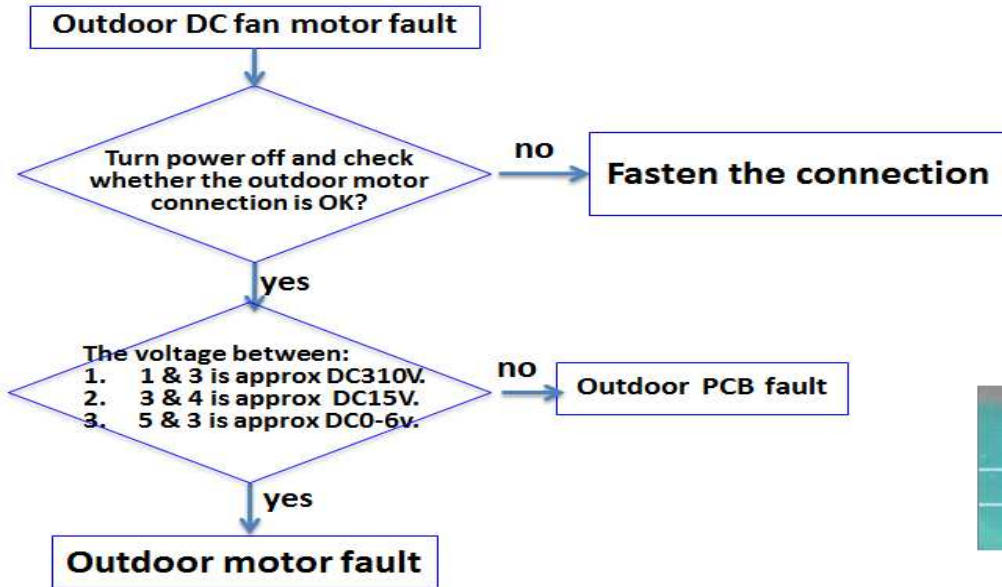

10.3.5 IPM protection

Outdoor display F1 LED1 flash 2 times; F22 LED1 flash 3 times

Under this error, please ensure the refrigerating system pressure is normal, and no block, then replace power module

Spare parts:
Power module
Refrigerant

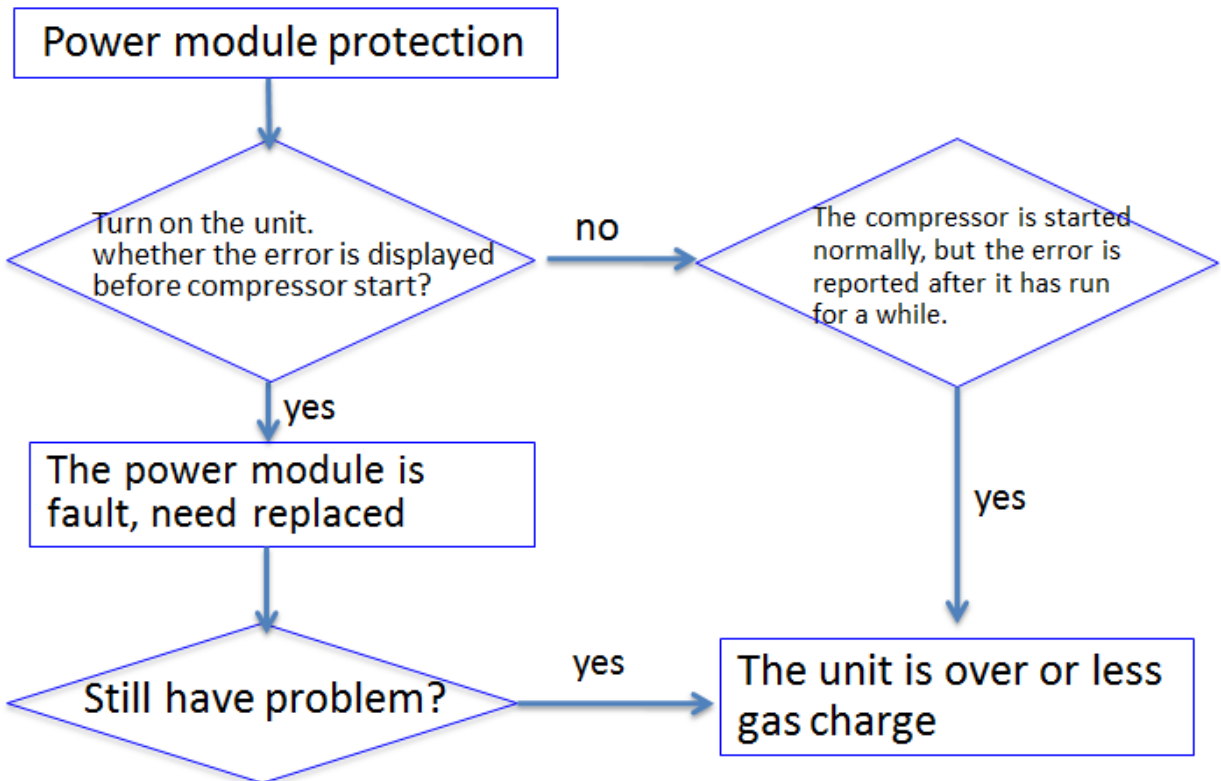

10.3.6 Over-current of the compressor

Outdoor Display F2, F23 LED1 flash 24 or 25 times

Spare parts:
Power module
Refrigerant

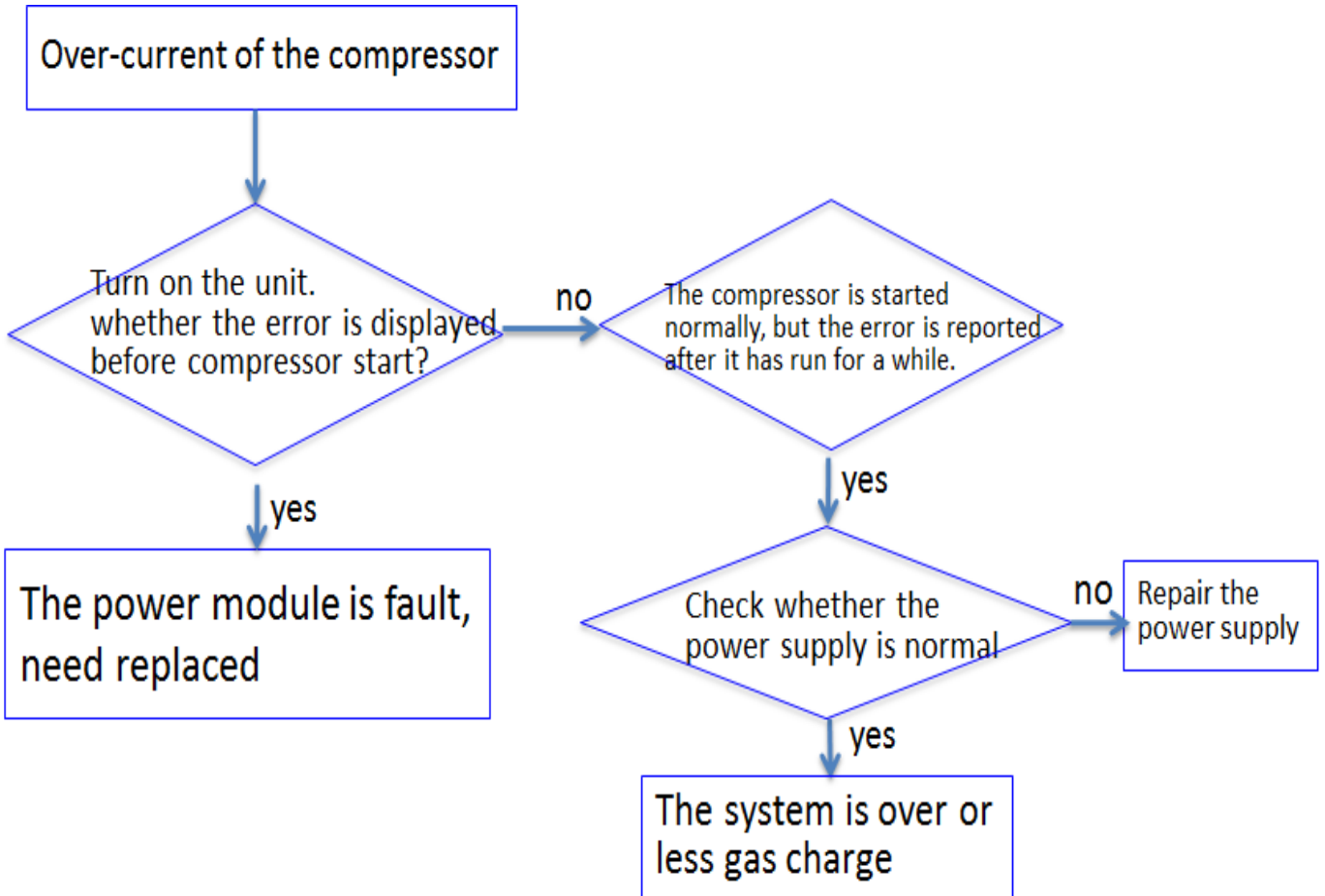

10.3.7 The communication fault between IPM and outdoor PCB

Outdoor display: F3 LED1 flash 4 times

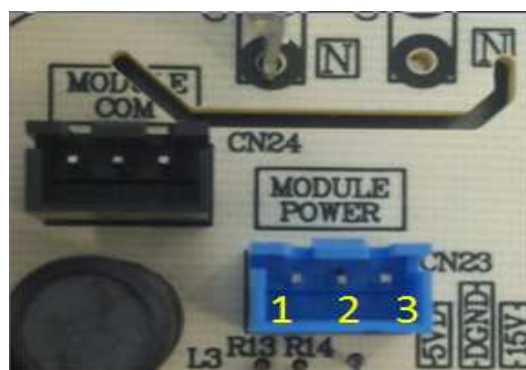
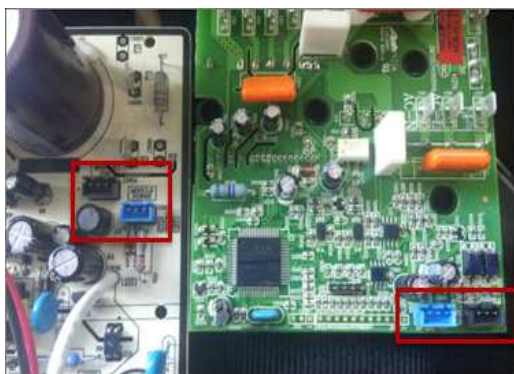
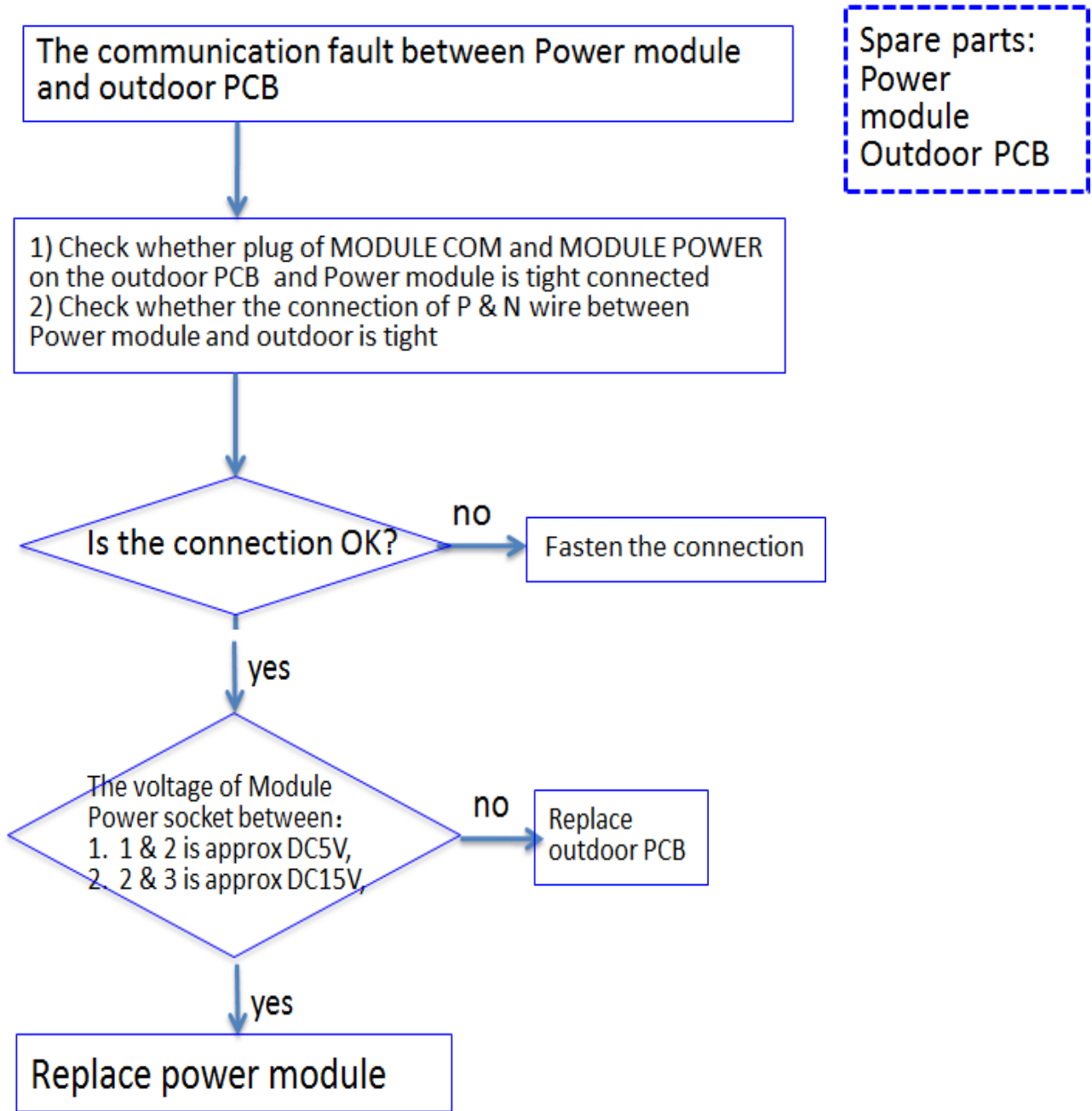

10.3.8 Power Supply Over or under voltage fault

Outdoor display: F19 LED1 flash 6 times

**Spare parts:
Power
module**

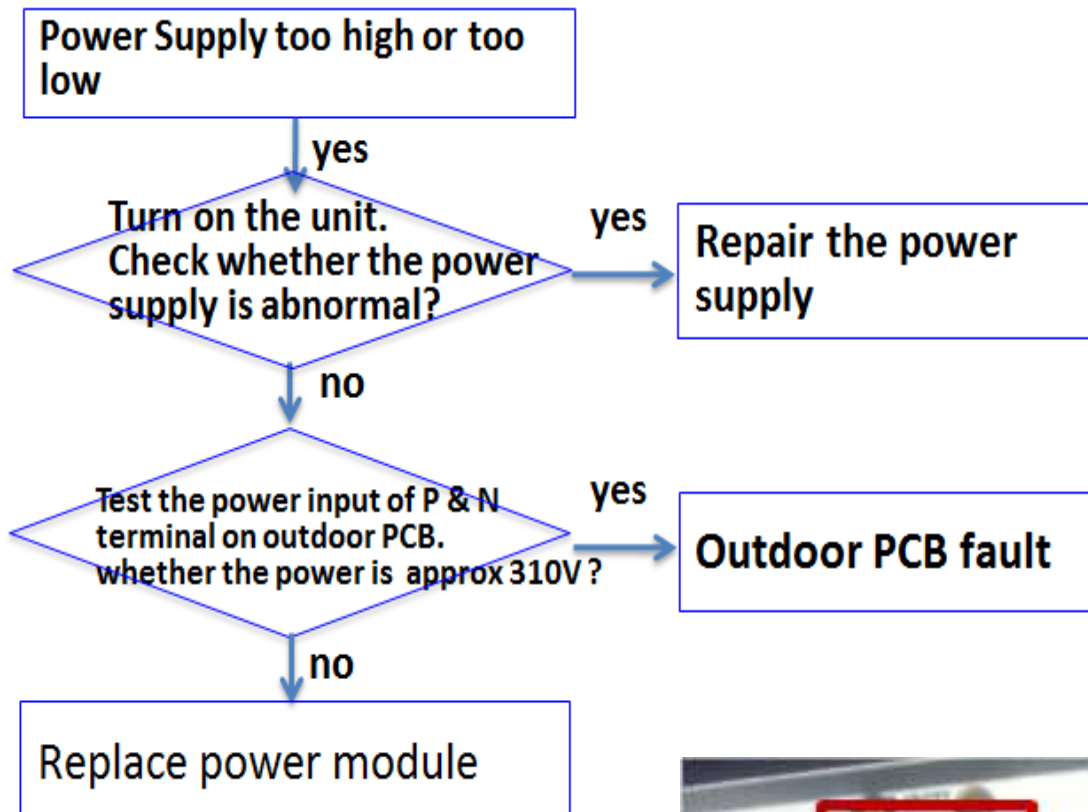

10.3.9 Overheat Protection For Discharge Temperature

Outdoor display: F4 LED1 flash 8 times

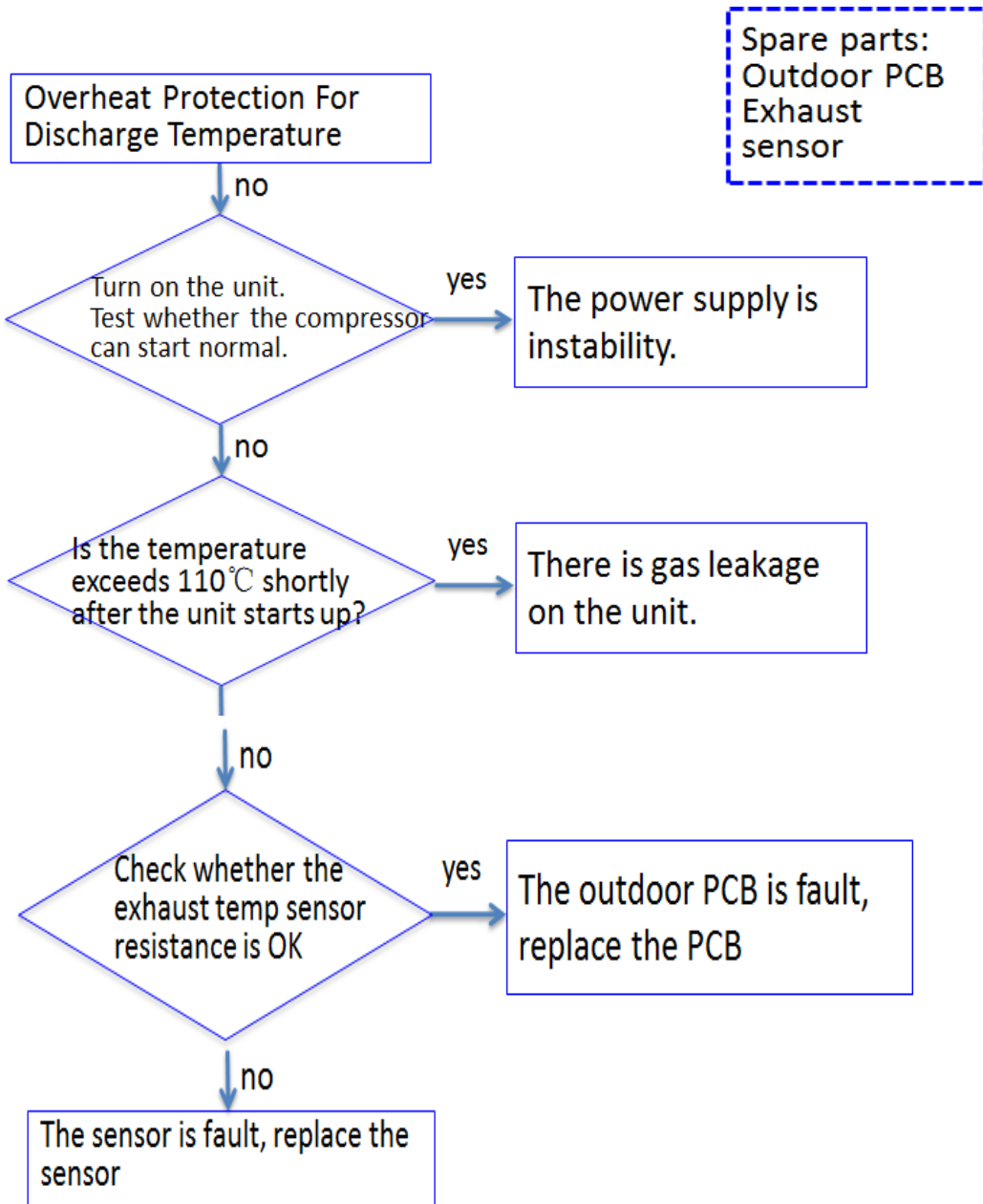

10.3.10 The communication fault between indoor and outdoor

Indoor display E7
 Outdoor display LED1 flash 15 times

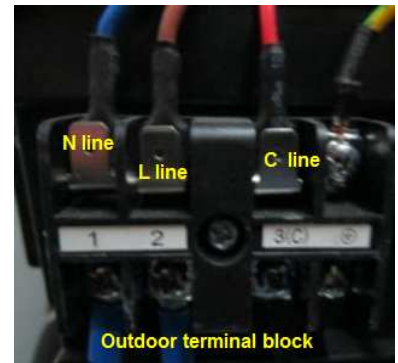
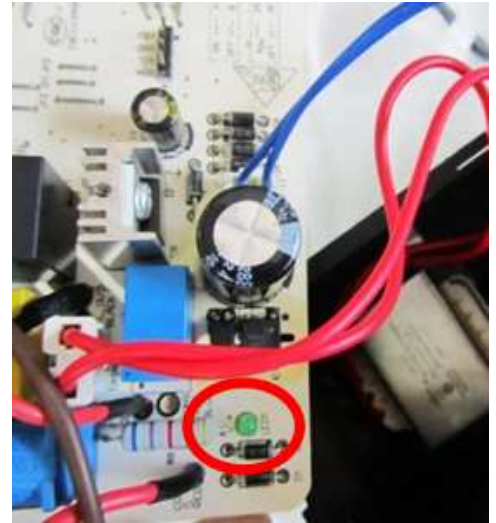
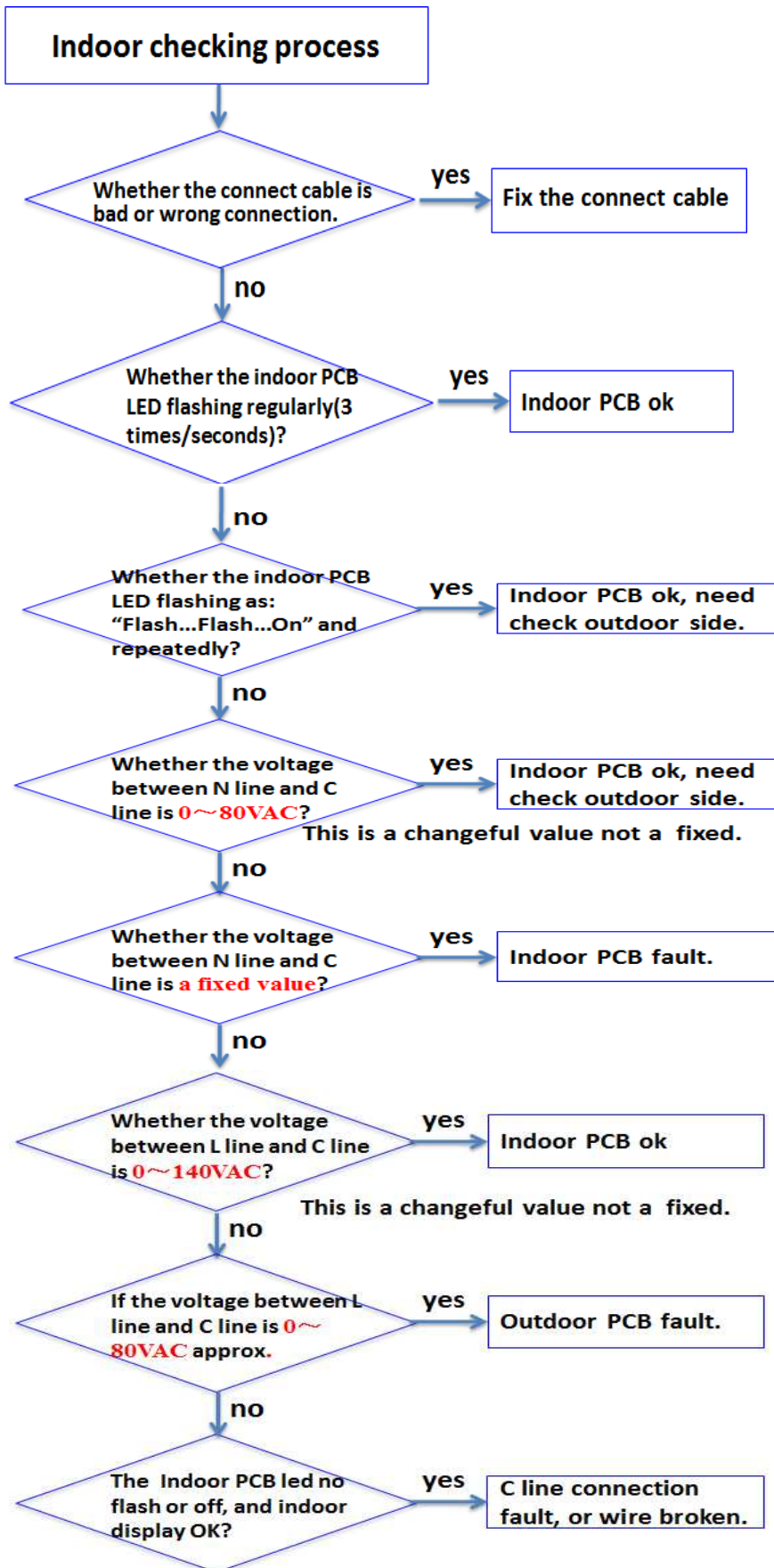

Outdoor checking process -1

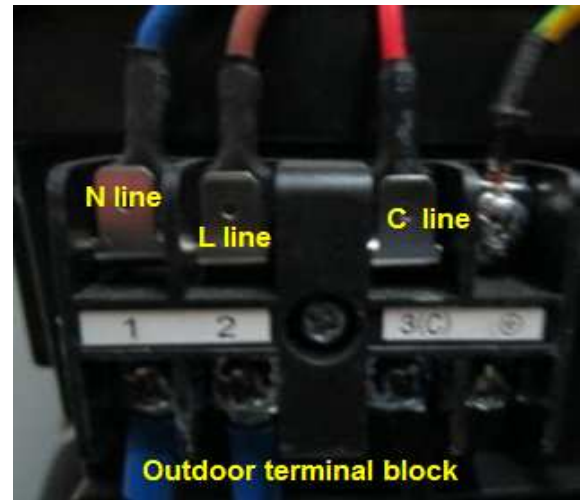
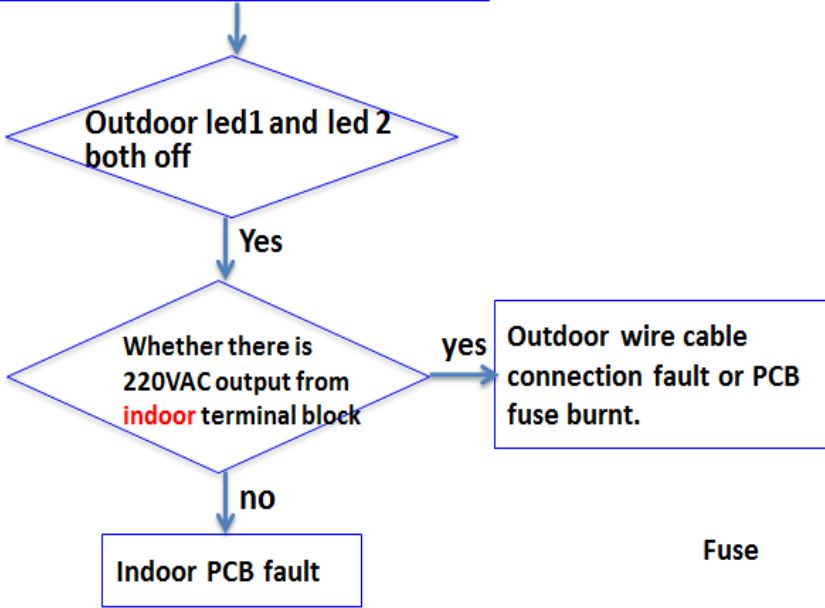

Fuse

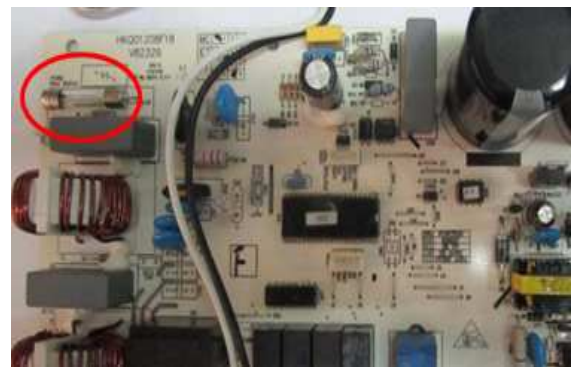

Outdoor checking process -2

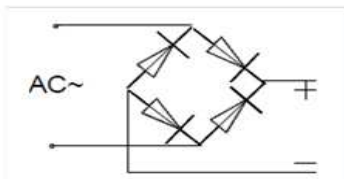
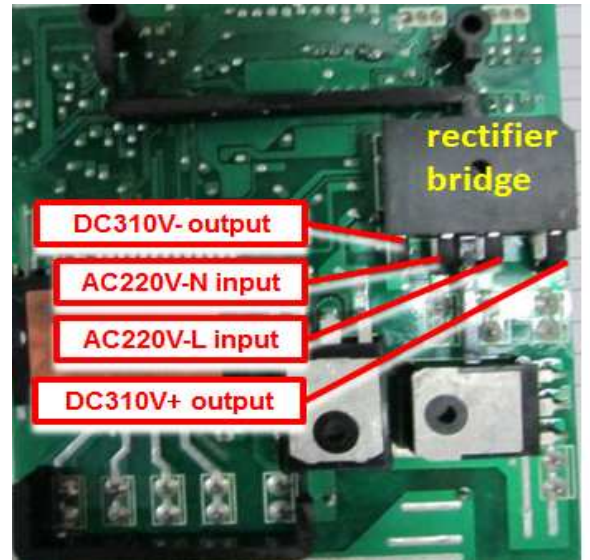
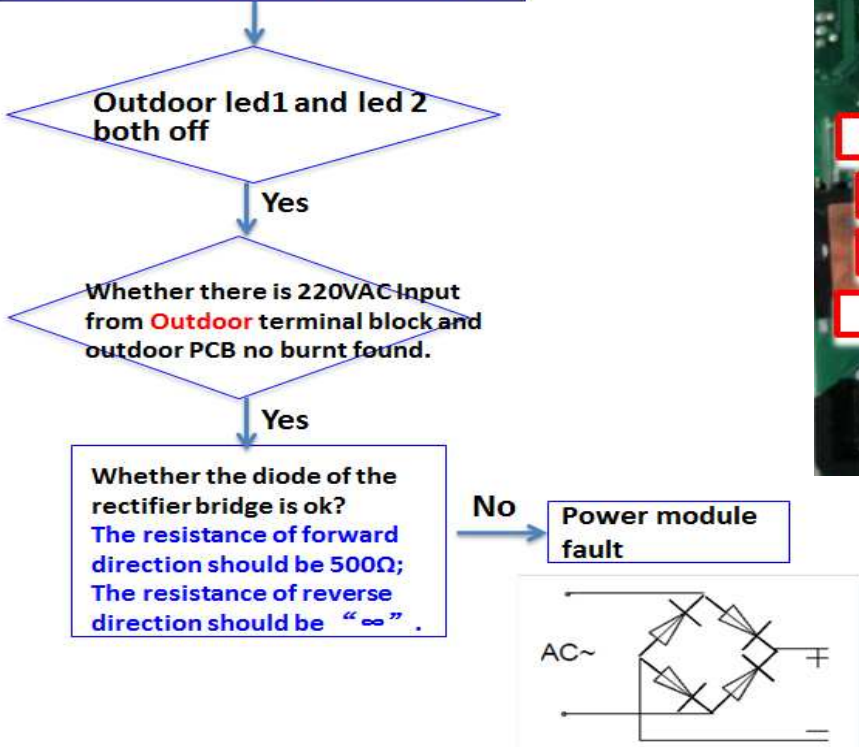

Outdoor checking process -3

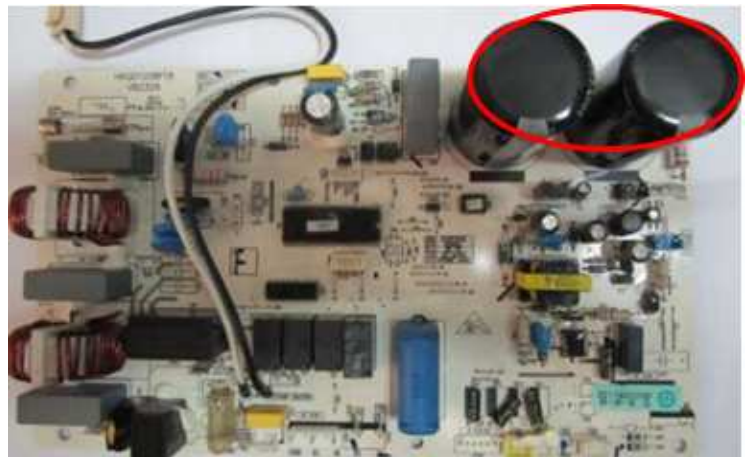

Outdoor checking process -4

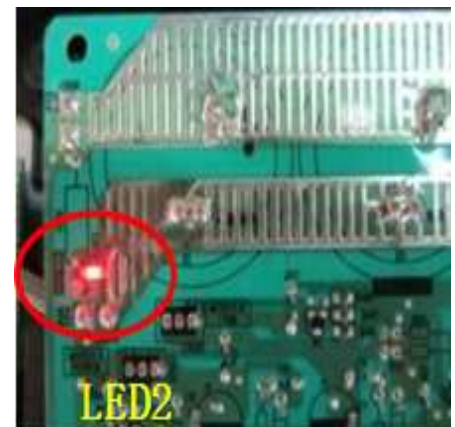
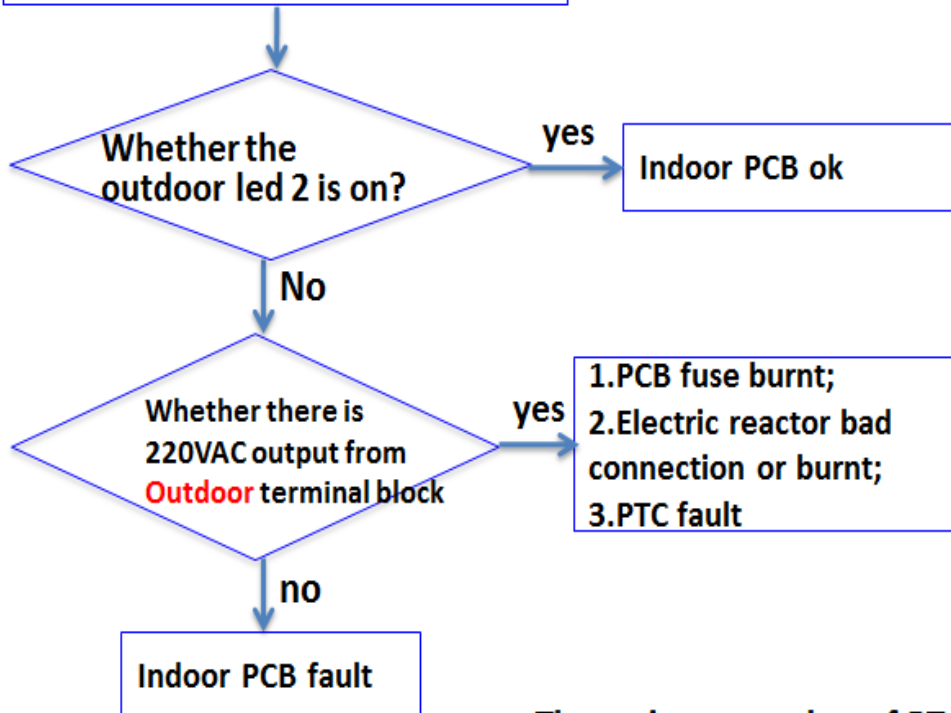

The resistance value of PTC should be $40\Omega \pm 10\%$



Outdoor checking process -5

1. Check whether the small capacitor on the outdoor PCB is welding spot is broken;
2. Test whether the rectifier diode is ok;
3. The resistance is normal;
4. Test whether the optocoupler diode is ok.

Note:

The diode parts should follow the characteristic of diode:
 The forward direction should be breaker;
 The reverse direction should be open.

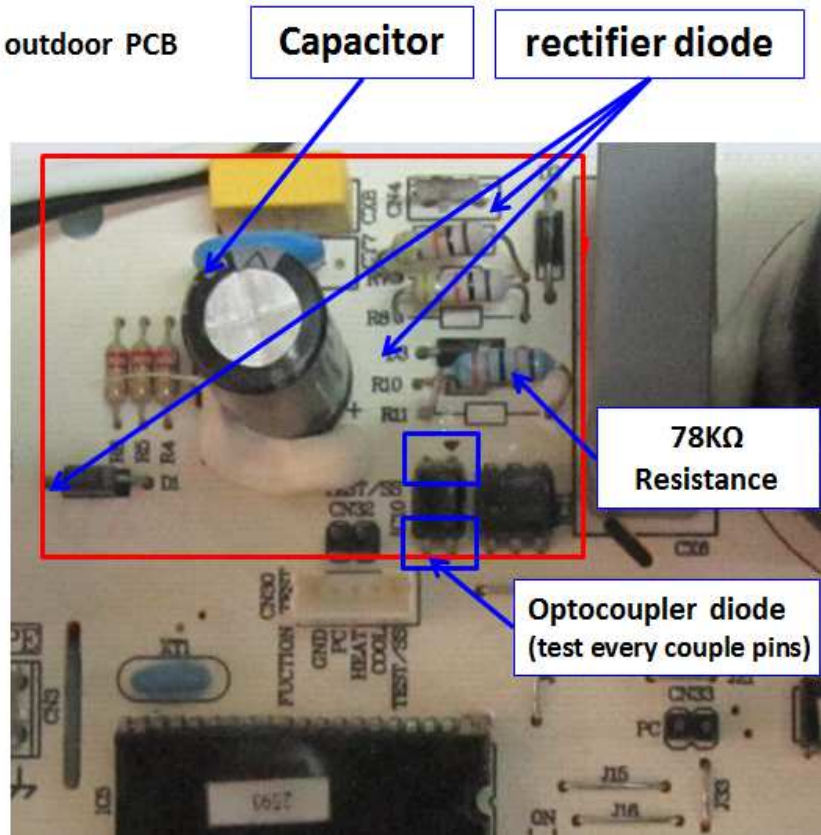

Outdoor checking process -6

1. Check whether the L7805 is OK;
 The voltage between Pin1 & Pin2 is +12VDC
 The voltage between Pin2 & Pin3 is +5VDC
2. The voltage of Module Power socket between
 1 & 2 is approx DC5V,
 2 & 3 is approx DC15V

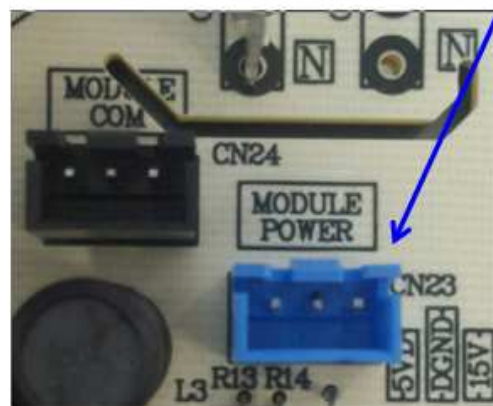

Outdoor checking process -7

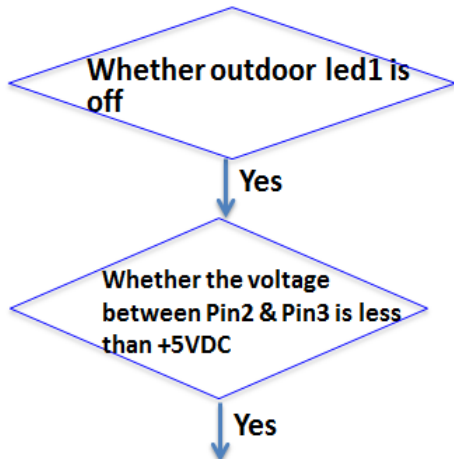

- 1. Power off the unit, and Pull off the outdoor fan motor connector,
- 2. Power on the unit, check whether the unit show F8 or LED1 flash 9 times?
- If yes, outdoor fan motor fault;
- If the voltage between Pin2 & Pin3 is still less than +5VDC, then the outdoor PCB fault.

L7805

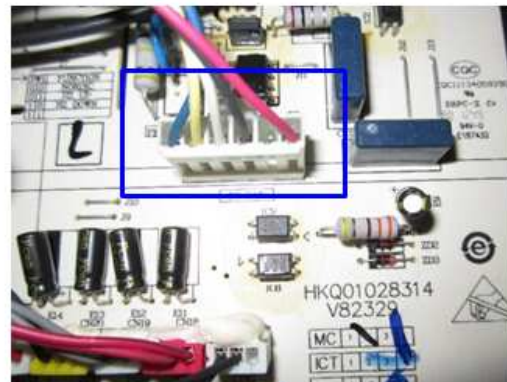

10.3.11 Compressor loss of synchronism detection

Outdoor Display F11 LED1 flash 18 times

The fault phenomenon is the compressor rotor demagnetization and couldn't reach the request frequency.
It is caused by the high exhaust temp or high running current.
In this fault we suggest change the compressor.

Spare parts:
Compressor

10.3.12 Compressor position detection circuit fault

Outdoor Display F28 LED1 flash 19 times

This is caused by the compressor position detection circuit fault, this circuit is located on the power module.
This fault should change the power module.

Spare parts:
Power module



11. Performance and curves diagrams

11.1 Cooling capacity-temperature curves

performance curves									
cooling value-temperature table									
indoor temp.	outdoor temp								
DB/WB	10°C	15°C	20°C	25°C	30°C	35°C	38°C	40°C	43°C
21/15°C	6272	6124.8	5950	5600	5460	5152	4900	4606	4360
24/16°C	6720	6510	6104	6020	5776.4	5390	5180	4956	4610
27/19°C	6804	6720	6454	6370	6098.4	5740	5460	5180	4830
30/22°C	7084	7000	6762	6552	6300	5950	5740	5524.4	5220
32/23°C	7504	7420	7308	6888	6650	6440	6126.4	5824	5570
35/24°C	8072	7840	7798	7336	7000	6720	6412	6160	5950

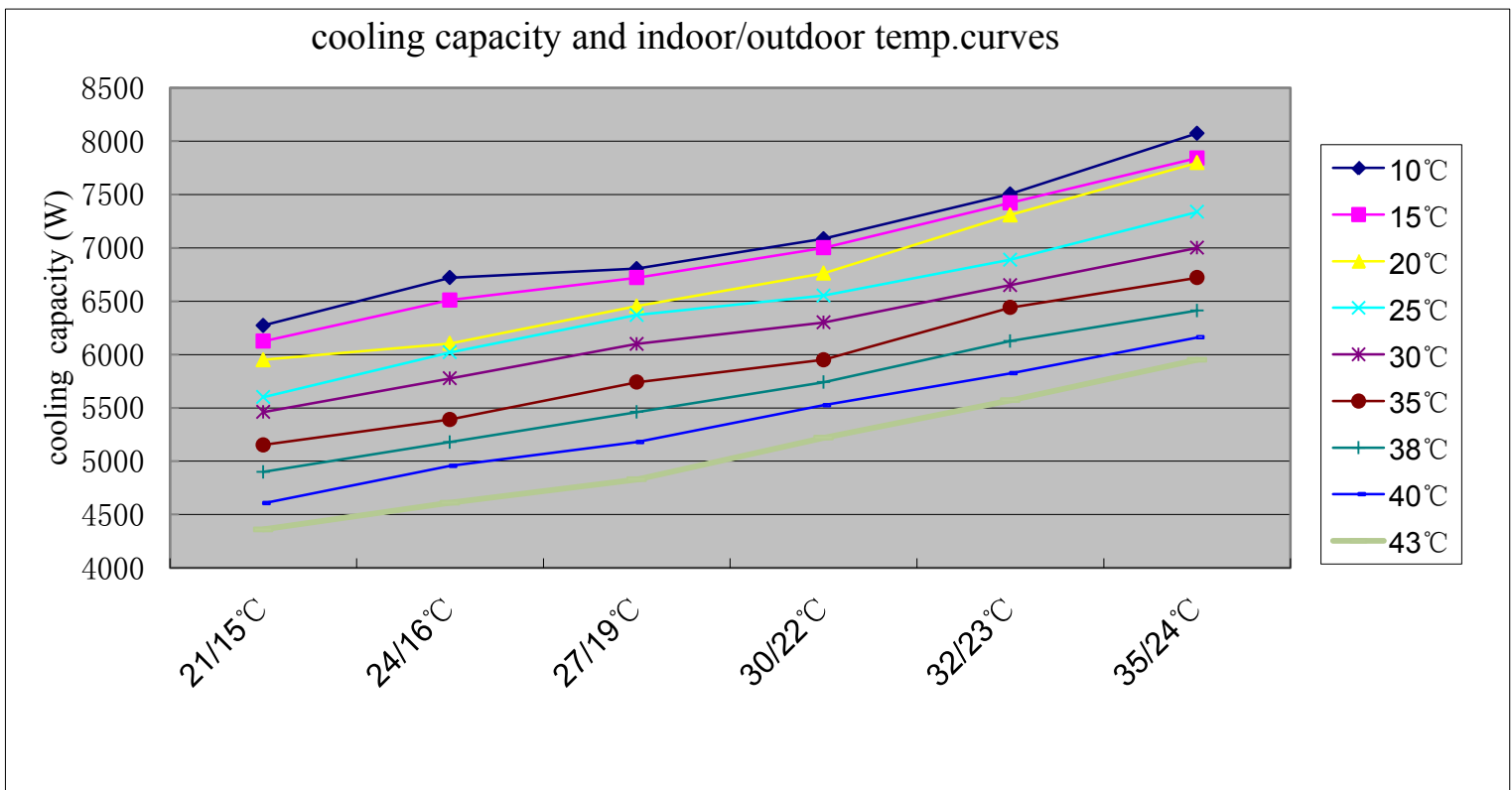

11.2 Cooling power consumption value- temperature curves

performance curves									
power consumption temp.table									
indoor temp.	outdoor temp.								
DB/WB	10°C	15°C	20°C	25°C	30°C	35°C	38°C	40°C	43°C
21/15°C	1557	1644	1708	1802	1878	1992	2086	2158	2198
24/16°C	1617	1689	1753	1840	1935	2048	2135	2200	2240
27/19°C	1681	1731	1780	1860	1973	2105	2185	2257	2297
30/22°C	1738	1784	1852	1926	2030	2162	2275	2332	2372
32/23°C	1780	1840	1905	1980	2086	2257	2389	2472	2512
35/24°C	1815	1897	1995	2096	2143	2313	2427	2534	2570

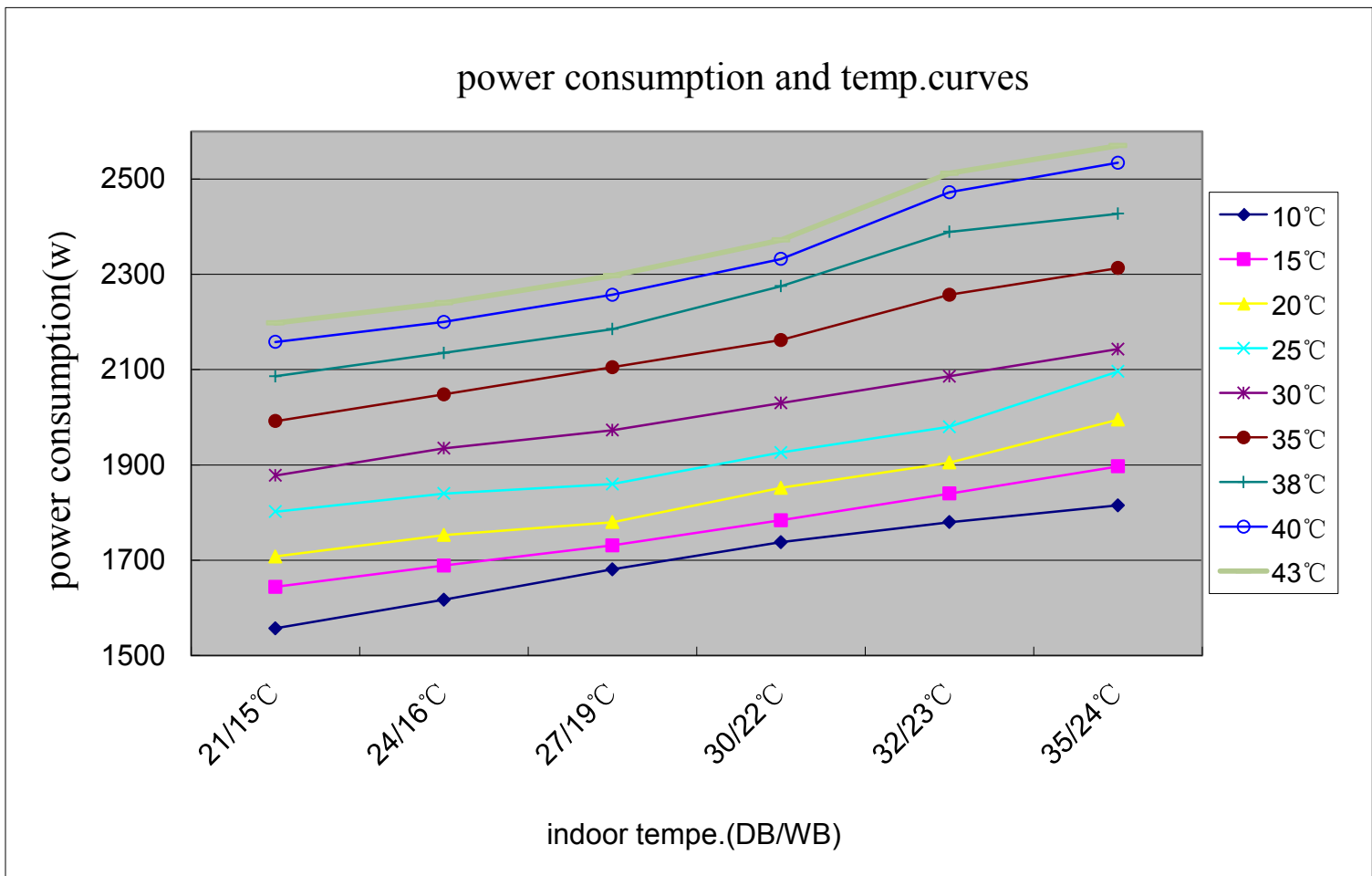

11.3 Cooling discharge pressure curves

performance curves			
cooling discharge pressure.table			
outdoor temp. (humidity 46%)	indoor temp.		
DB/WB	21/15°C	27/19°C	35/24°C
10°C	1899	2010	2107
15°C	1949	2037	2141
20°C	1976	2064	2178
25°C	2079	2144	2287
30°C	2211	2385	2478
35°C	2429	2546	2674
38°C	2615	2734	2901
40°C	2940	3082	3234
43°C	3359	3484	3650

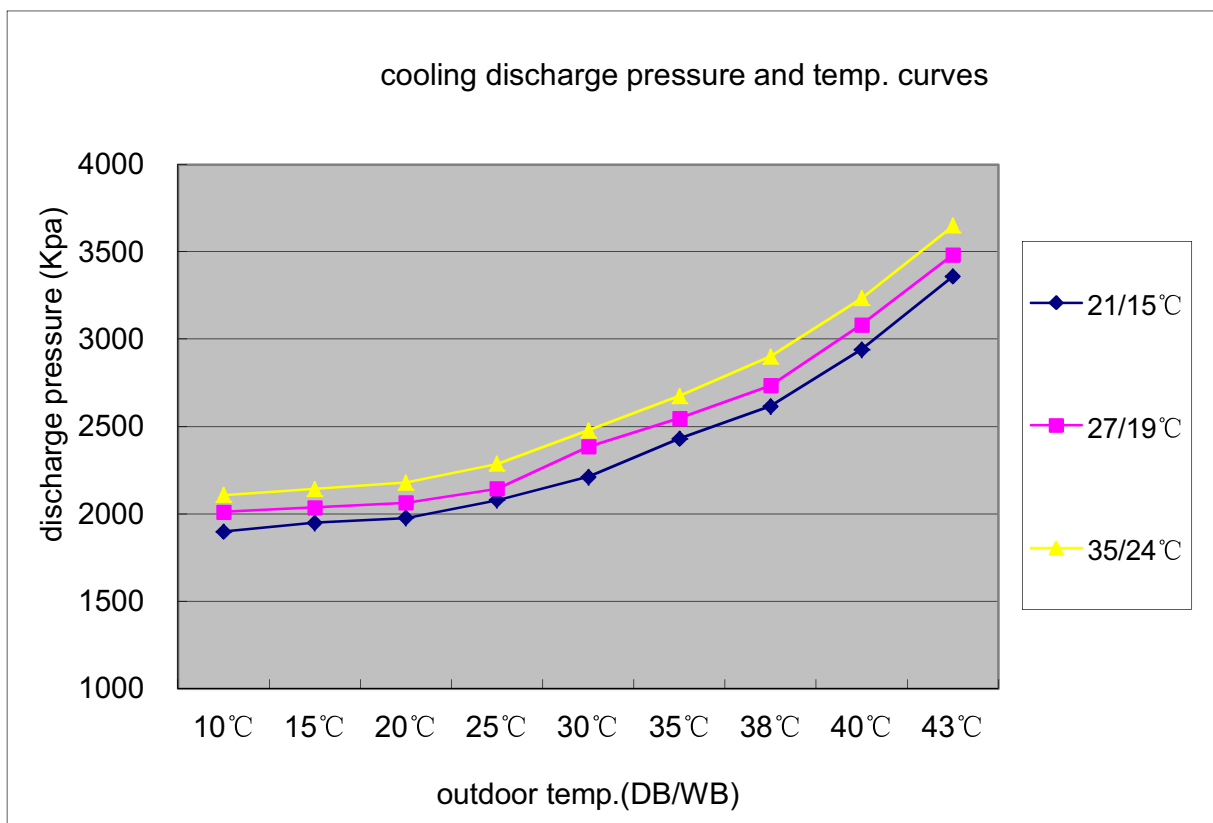

11.4 Cooling suction pressure curves

performance curves			
cooling suction pressure.table			
outdoor temp. (humidity 46%)	indoor temp.		
DB/WB	21/15°C	27/19°C	35/24°C
10°C	757	886	1029
15°C	765	895	1040
20°C	772	913	1050
25°C	813	922	1072
30°C	856	971	1082
35°C	864	981	1139
38°C	910	1011	1163
40°C	1001	1112	1279
43°C	1101	1201	1394

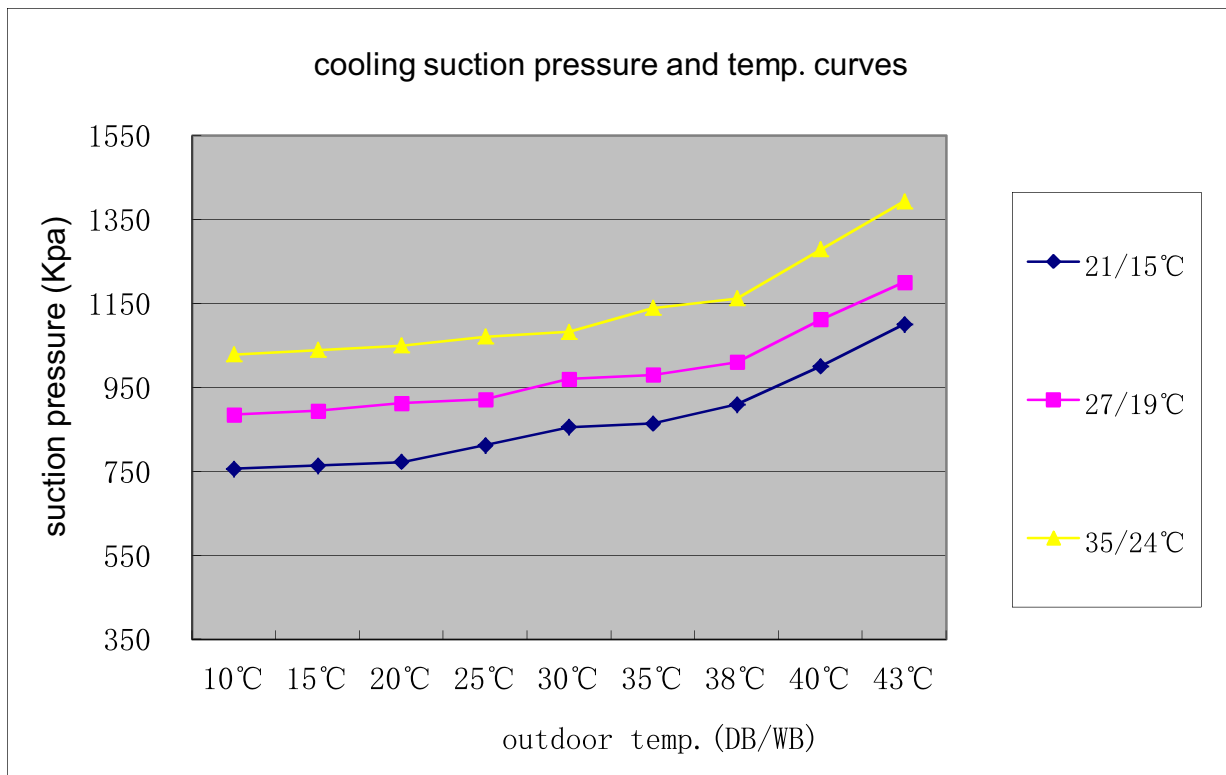

11.5 Heating capacity-temperature curves

performance curves			
heating capacity and indoor/outdoor temp.table			
outdoor temp.	indoor temp.(humidity 46%)		
DB/WB	10°C	20°C	27°C
-15°C	5194	4686	4190
-10°C	6526	5877	5158
-7/-8°C	7920	7181	6289
2/1°C	9780	8722	7663
7/6°C	9629	8477	7481
12/11°C	9417	8268	6892
18/16°C	7209	6537	5727
24/20°C	5941	5252	4698

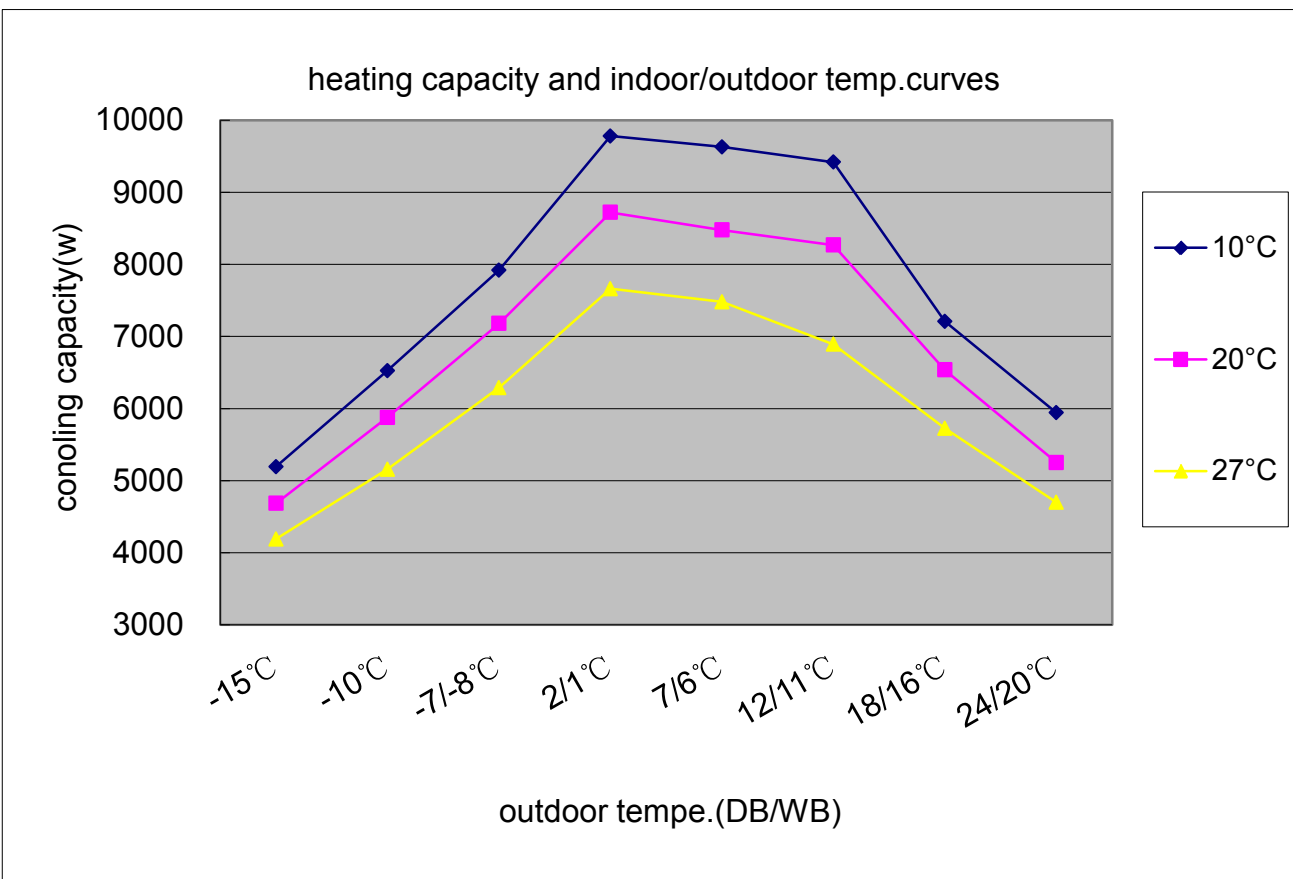

11.6 Heating power consumption value- temperature curves

performance curves			
power consumption value-temp.table			
outdoor temp.	indoor temp.(humidity 46%)		
DB/WB	10°C	20°C	27°C
-15°C	1972	2141	2277
-10°C	2216	2366	2515
-7/-8°C	2424	2669	2800
2/1°C	2578	2804	2988
7/6°C	2303	2535	2660
12/11°C	1894	2021	2149
18/16°C	1515	1617	1719
24/20°C	985	1084	1205

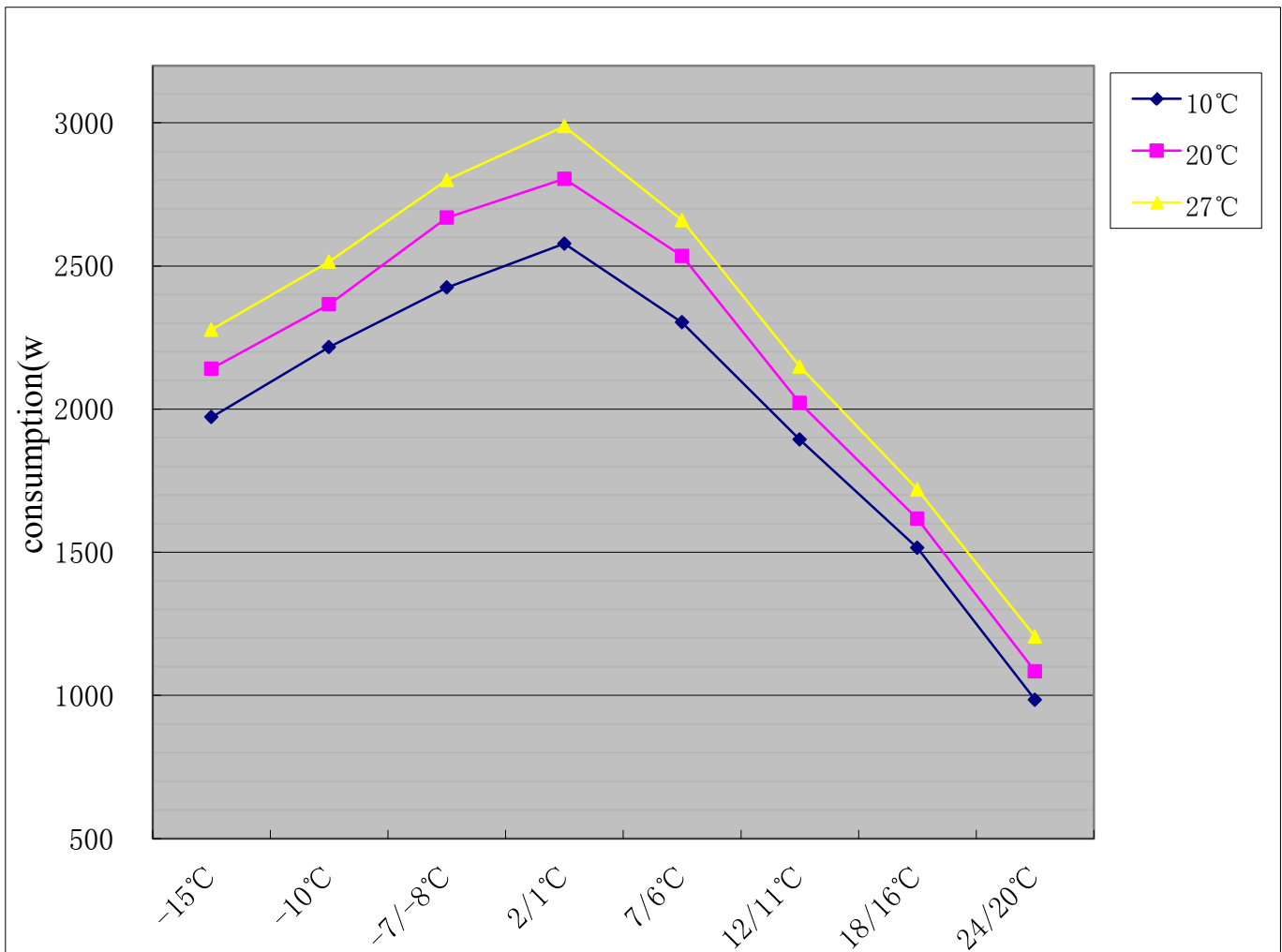

11.7 Heating discharge pressure curves

performance curves			
heating discharge pressure.table			
outdoor temp	indoor temp.		
DB/WB	10°C	20°C	27°C
-15°C	2644	2764	2867
-10°C	2789	2980	3073
-7/-8°C	3259	3411	3563
2/1°C	3461	3698	3883
7/6°C	3409	3590	3672
12/11°C	3346	3482	3606
18/16°C	3098	3273	3351
24/20°C	2638	2782	2923

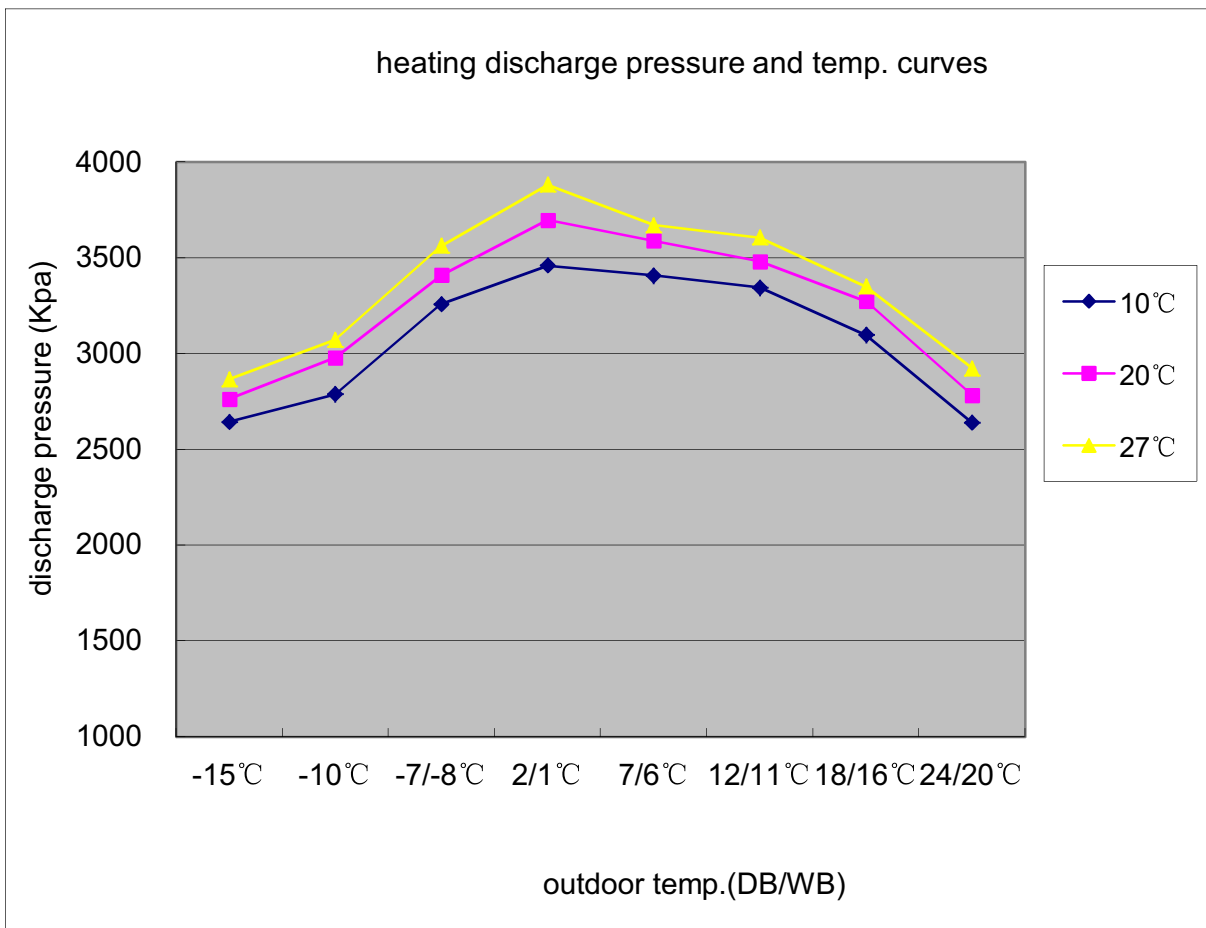

11.8 Heating suction pressure curves

performance curves			
heating suction pressure.table			
outdoor temp	indoor temp.		
DB/WB	10℃	20℃	27℃
-15℃	345	385	405
-10℃	398	428	447
-7/-8℃	492	532	551
2/1℃	611	651	670
7/6℃	744	784	803
12/11℃	844	884	904
18/16℃	1011	1051	1071
24/20℃	1197	1237	1257

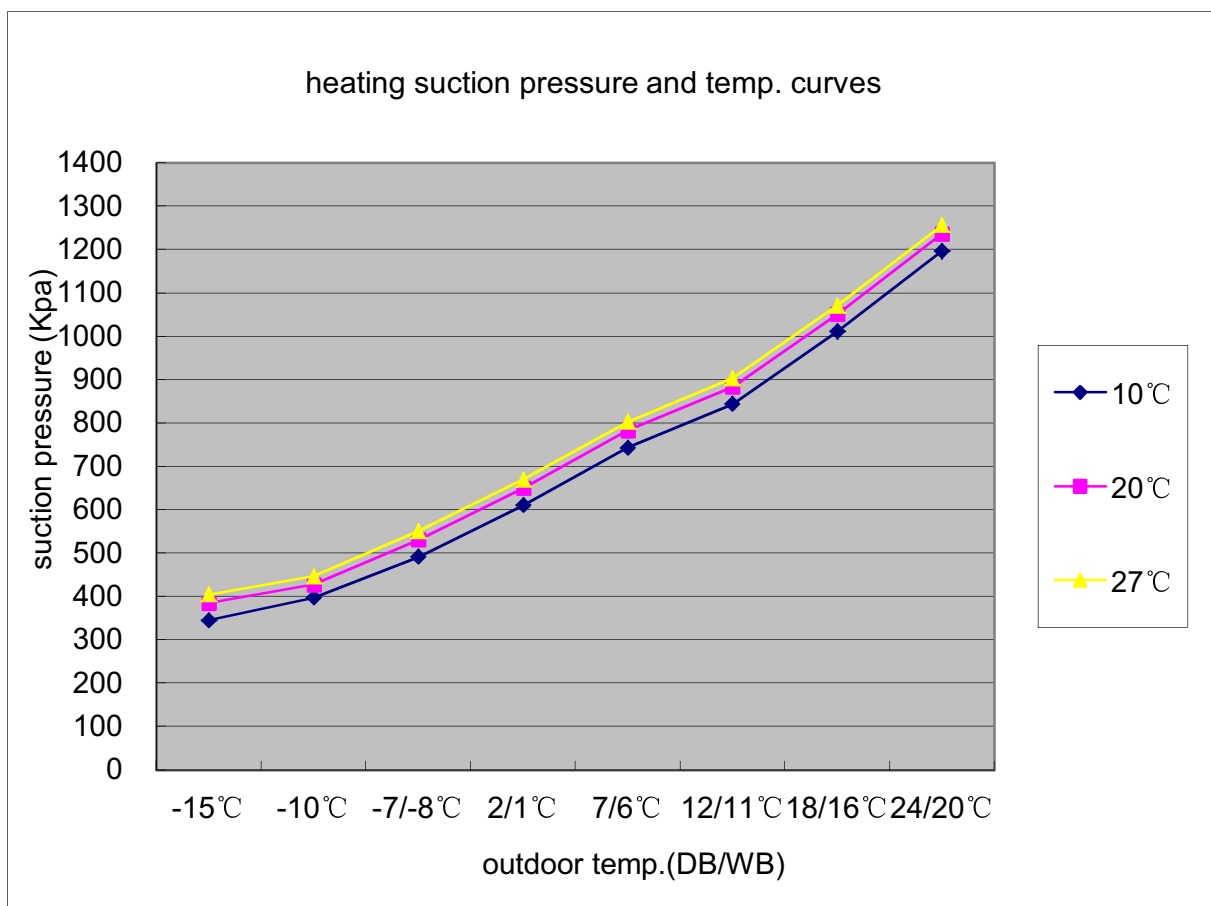

12 Circuit diagrams

12.1 Outdoor unit control board Circuit Diagrams

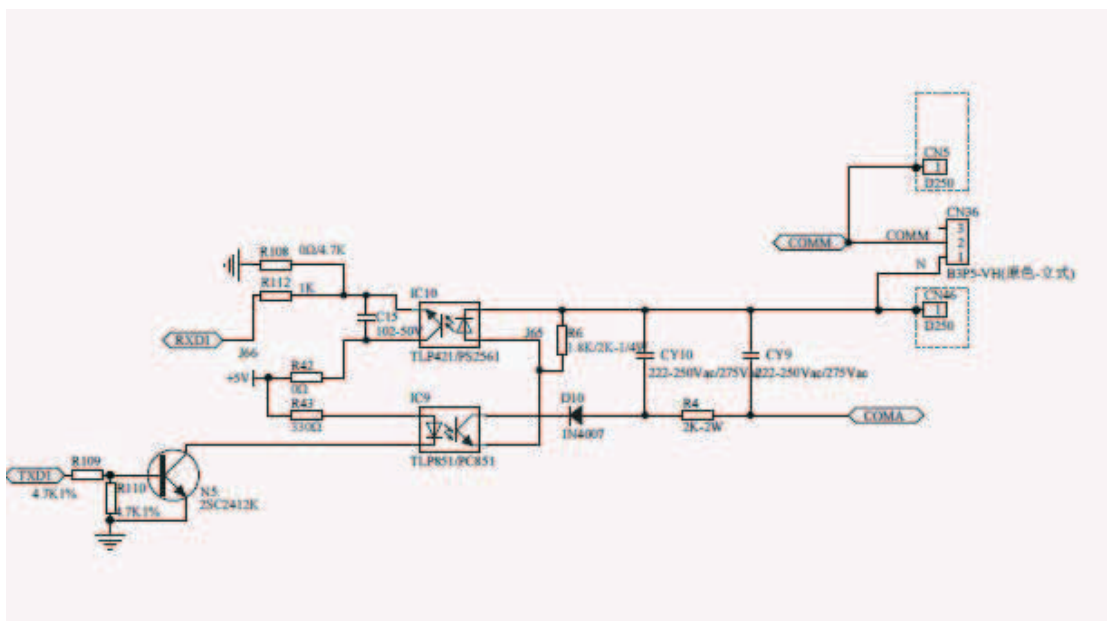
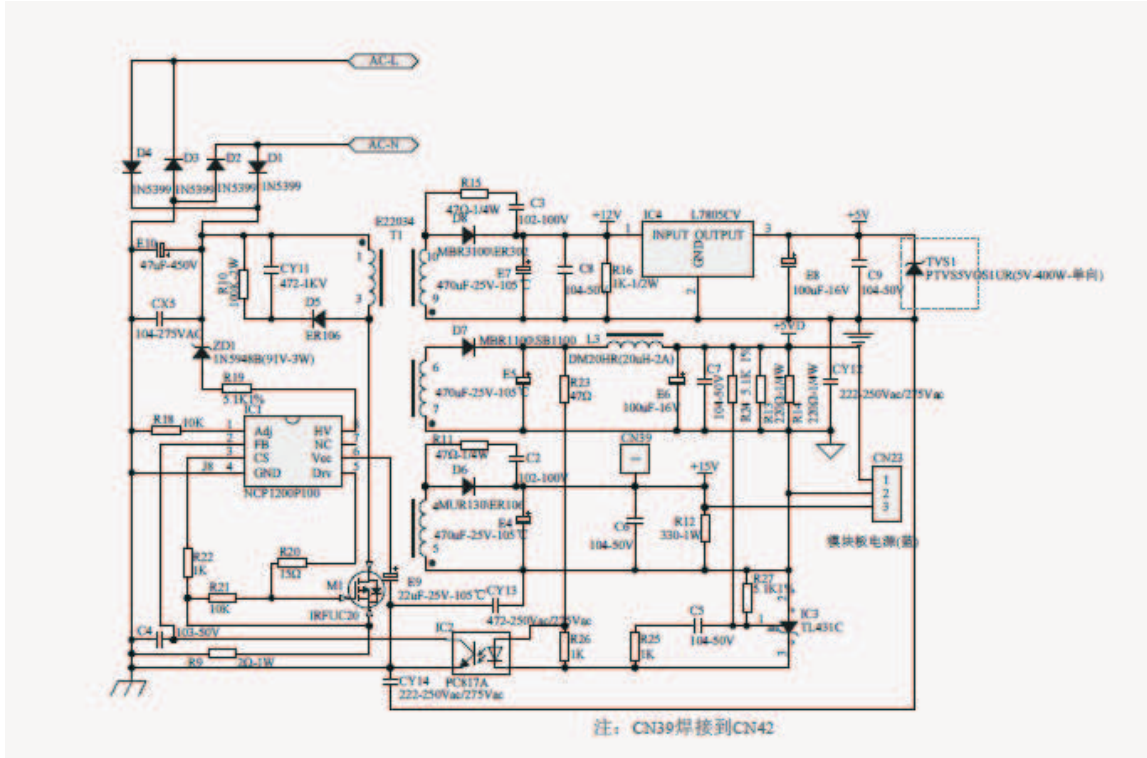

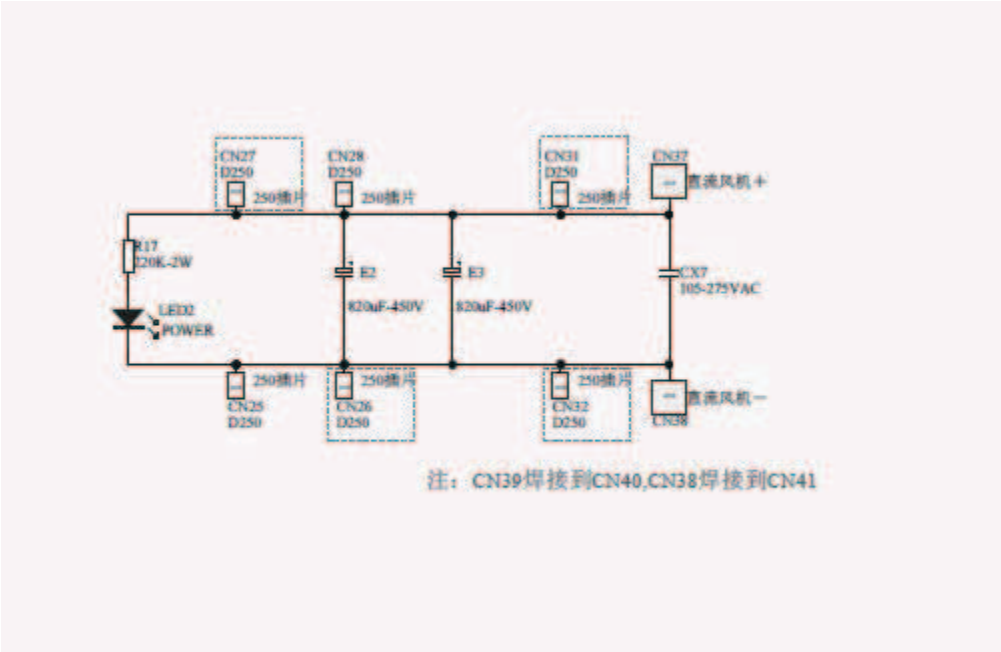
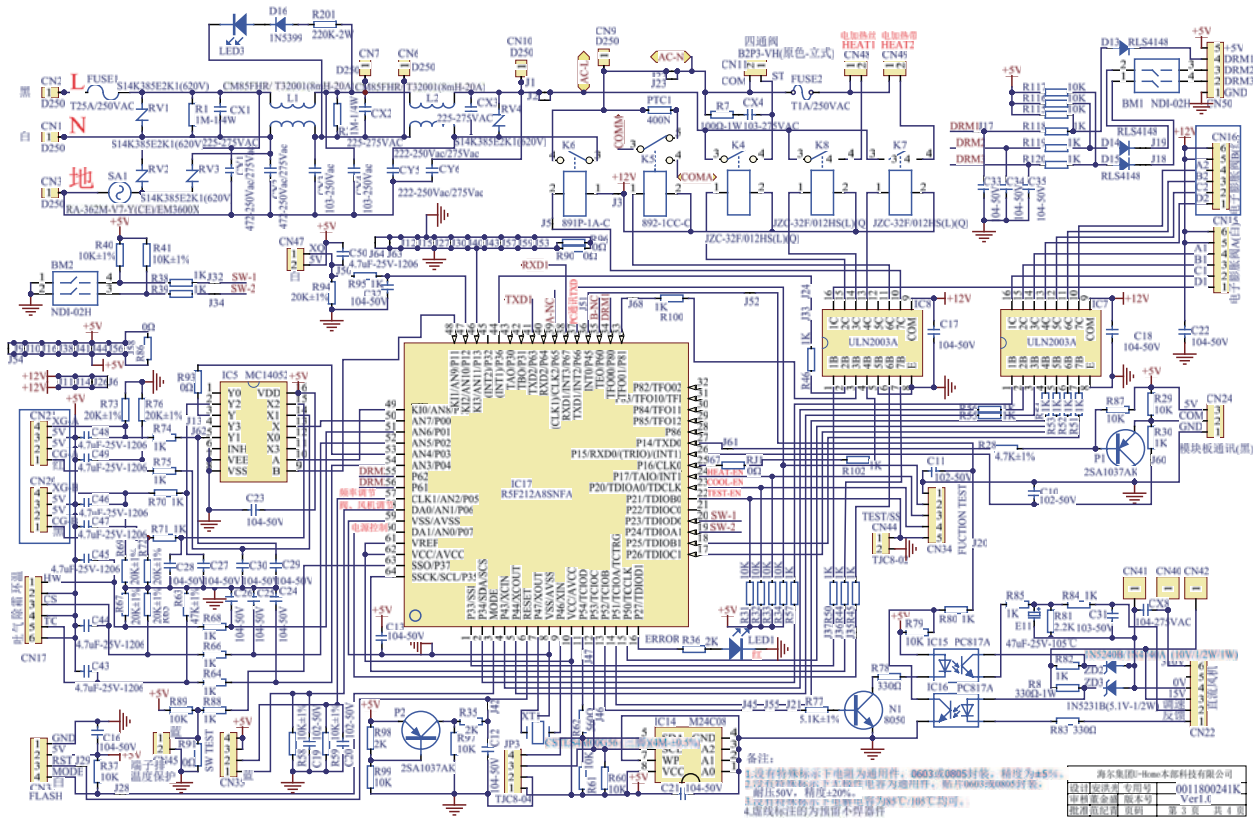

12.2 Module board Circuit Diagram

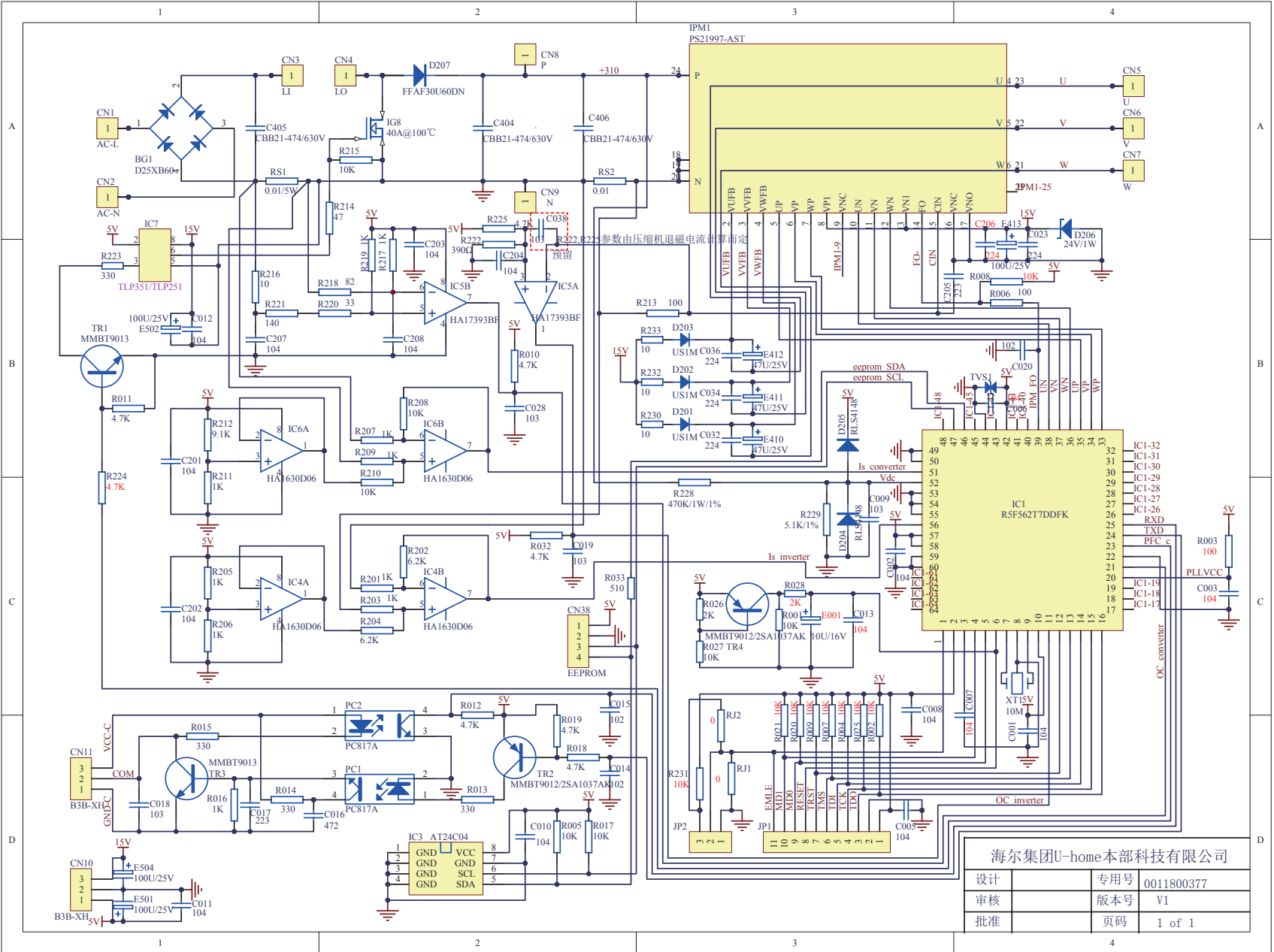

海尔集团U-home本部科技有限公司

设计	专用号	0011800377
审核	版本号	V1
批准	页码	1 of 1

Sincere Forever

Haier Group

Haier Industrial Park, No.1, Haier Road

266101, Qingdao, China_

Http: //www.haier.com

Edited by : Zhen Lingyun

Zhang Jing

Signed by : Zhang Xianqiang

Approved by: He Shiquan



REMOVAL PROCEDURE

Wall Mounted Type ON/OFF-Series SERIES:70 PLATFORM



WARNING

This service information is designed for experienced repair technicians only and is not designed for use by the general public. It does not contain warnings or cautions to advise non-technical individuals of potential dangers in attempting to service a product. Products powered by electricity should be serviced or repaired only by experienced professional technicians. Any attempt to service or Repair the product or products dealt with in this service information by anyone else could result in serious injury or death

2014 (Qingdao Haier Air Conditioner General corp. , Ltd)
All rights reserved. Unauthorized copying and distribution is a violation of law

Haier Group

Version: V1

Date: 2014-04-30

1. Removal of Outdoor panel

Procedure

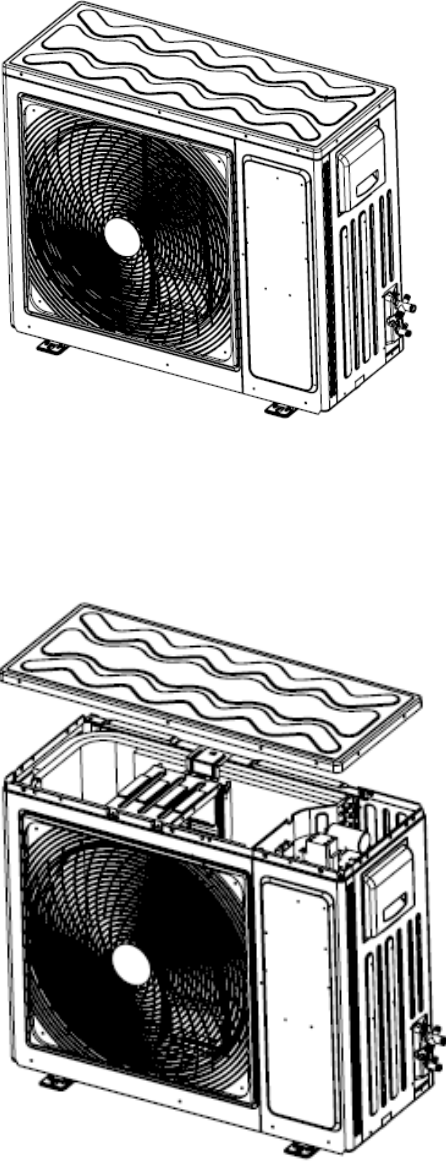

Warning Be sure to wait 10 minutes or more after turning off all power supplies before disassembling work

Step		Procedure	Points
1. Remove the panels			
1	Loosen the 8 screws and lift the top panel.		

Step		Procedure	Points
2	Loosen the screws of the panel, pull and remove the front panel.		



2. Removal of Electrical Box

Procedure

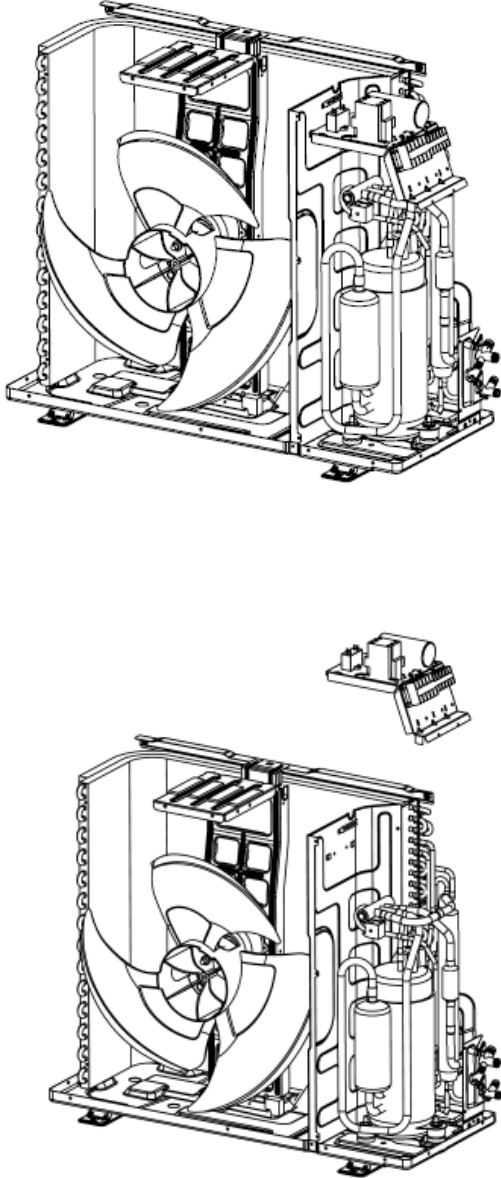

Warning Be sure to wait 10 minutes or more after turning off all power supplies before disassembling work

Step		Procedure	Points
1	Remove the fixing screws, Than lift the electrical box.		

3. Removal of Fan and Fan Motor

Procedure



Warning Be sure to wait 10 minutes or more after turning off all power supplies before disassembling work

Step		Procedure	Points
1	Loosen the fixing screw and remove the fan.		Put the head wire through the back of the motor when assembling.(so as not to be entangled with the propeller fan)

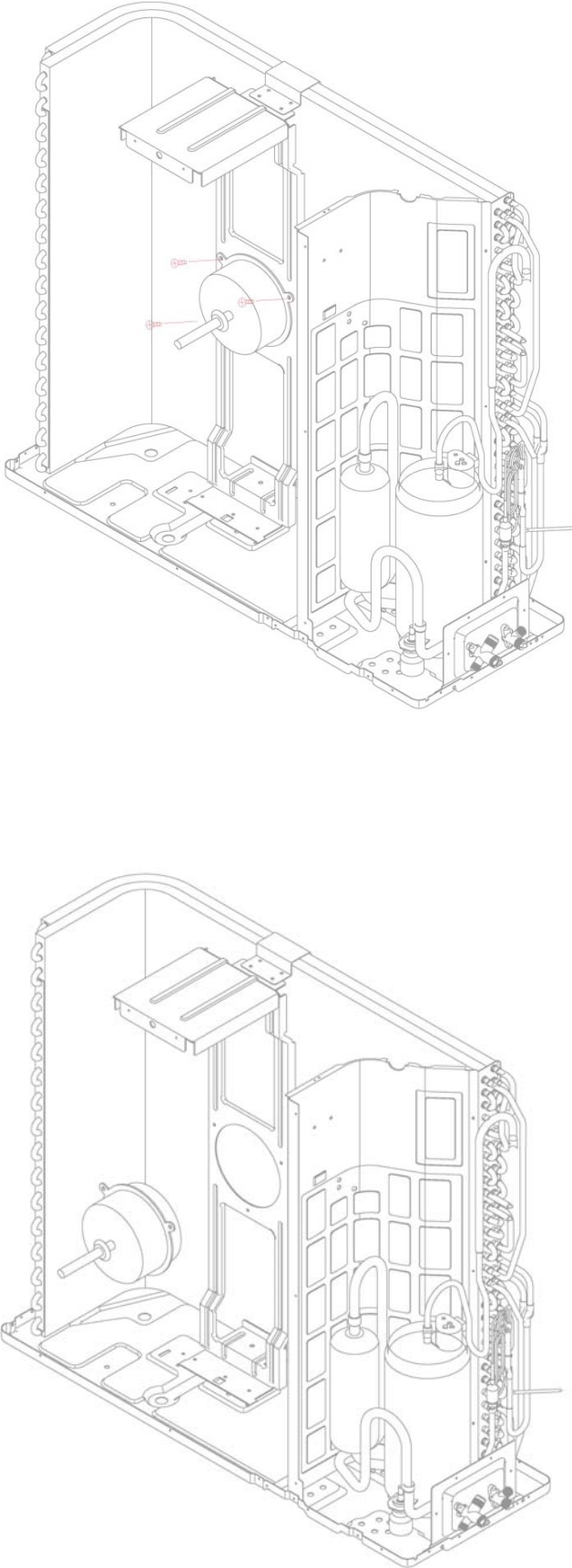
Step		Procedure	Points
2	Loosen the fixing screws and remove the fan motor.		

4. Removal of fan motor bracket and partition

Procedure



Warning Be sure to wait 10 minutes or more after turning off all power supplies before disassembling work

Step		Procedure	Points
1	Loosen the fixing screws and remove the fan motor bracket.		

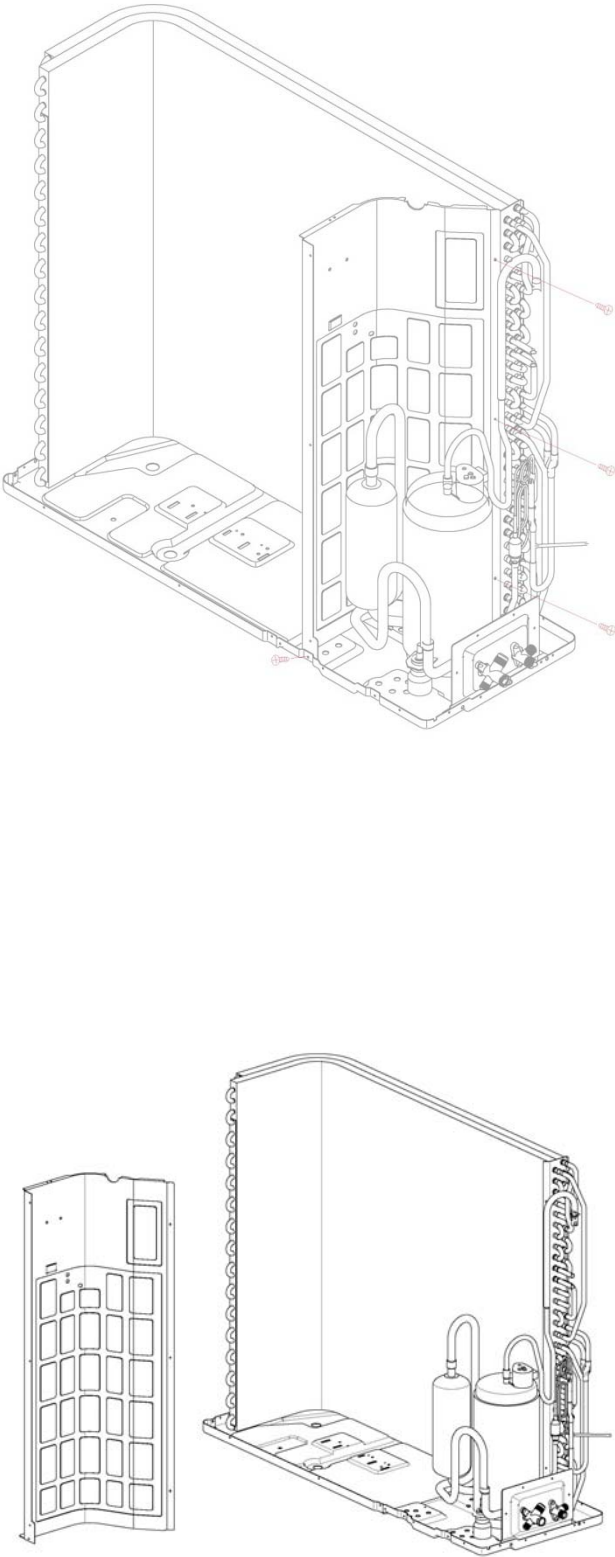
Step		Procedure	Points
2	<p>Loosen the fixing screws, the partition plate has a hook on the lower side, than lift and pull the proof plate.</p>		<p>When assembling, fit the lower hook into the bottom frame.</p>



5. Removal of compressor and heat exchanger



Procedure

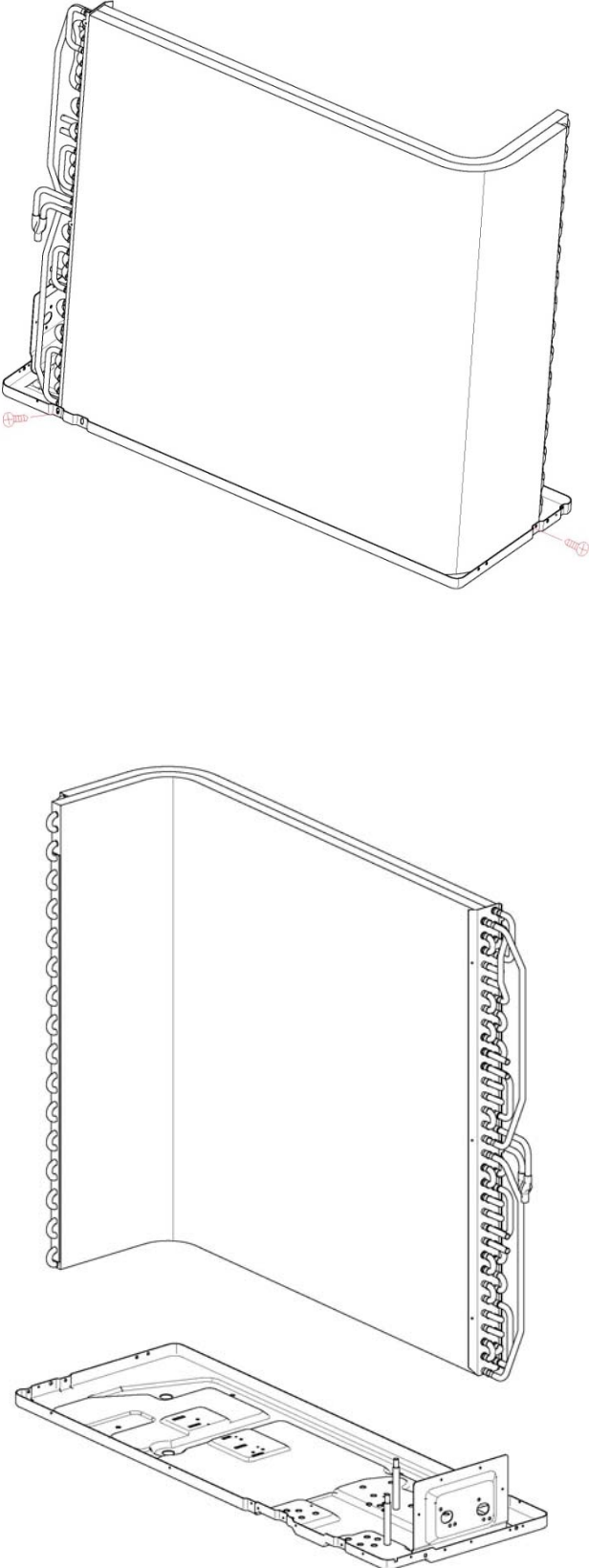

Warning Be sure to wait 10 minutes or more after turning off all power supplies before disassembling work

Step		Procedure	Points
1	<p>Cut down the connecting pipe and put out the compressor and remove the valve bracket.</p>		

Step		Procedure	Points
2	<p>Loosen the marked fixing screws and remove the heat exchanger.</p>		

	<p>Read the precautions in this manual carefully before operating the unit.</p>		<p>This appliance is filled with R32.</p>
---	---	---	---

Keep this manual where the user can easily find it.

WARNING:

- Do not use means to accelerate the defrosting process or to clean, other than those recommended by the manufacturer.
- The appliance must be stored in a room without continuously operating ignition sources (for example: open flames, an operating gas appliance or an operating electric heater).
- Do not pierce or burn.
- Be aware that refrigerants may not contain an odour.
- The appliance must be installed, operated and stored in a room with a floor area larger than 3 m².
- If the supply cord is damaged, it must be replaced by the manufacturer, its service agent or similarly qualified persons in order to avoid a hazard.
- This appliance can be used by children aged 8 years and above and persons with reduced physical, sensory or mental capabilities or lack of experience and knowledge if they have been given supervision or instruction concerning use of the appliance in a safe way and understand the hazards involved. Children shall not play with the appliance. Cleaning and user maintenance shall not be made by children without supervision.
- The wiring method should be in line with the local wiring standard.
- All the cables shall have got the European authentication certificate. During installation, when the connecting cables break off, it must be assured that the grounding wire is the last one to be broken off. The explosion-proof breaker of the air conditioner should be all-pole switch. Distance between its two contacts should not be no less than 3mm. Such means for disconnection must be incorporated in the wiring.
- Make sure installation is done according to local wiring regulation by professional persons.
- Make sure ground connection is correct and reliable.
- A leakage explosion-proof breaker must be installed.
- Do not use a refrigerant other than the one indicated on the outdoor unit (R32) when installing, moving or repairing. Using other refrigerants may cause trouble or damage to the unit, and personal injury.



No fire source around the place of installation



Read operator' manual



Read technical manual



Operator' manual; operating instructions

Installation Manual of Room Air Conditioner

Preparation

Necessary Tools for Installation

- Driver
- Nipper
- Hacksaw
- Hole core drill
- Spanner(17,19 and 26mm)
- Gas leakage detector or soap-and-water solution
- Torque wrench (17mm,22mm,26mm)
- Pipe cutter
- Flaring tool
- Knife
- Measuring tape
- Reamer

Power Source

- Before inserting power plug into receptacle, check the voltage without fail. The power source is the same as the corresponding name plate.
- Install an exclusive branch circuit of the power.
- A receptacle shall be set up in a distance where the power cable can be reached. Do not extend the cable by cutting it.

Selection of Installation Place

Indoor Unit

- Place, robust not causing vibration, where the body can be supported sufficiently.
- Place, not affected by heat or steam generated in the vicinity, where inlet and outlet of the unit are not disturbed.
- Place, possible to drain easily, where piping can be connected with the outdoor unit.
- Place, where cold air can be spread in a room entirely.
- Place, nearby a power receptacle, with enough space around. (Refer to drawings).
- Place where the distance of more than 1m from televisions, radios, wireless apparatuses and fluorescent lamps can be left.
- In the case of fixing the remote controller on a wall, place where the indoor unit can receive signals when the fluorescent lamps in the room are lightened.

Outdoor Unit

- Place, which is less affected by rain or direct sunlight and is sufficiently ventilated.
- Place, possible to bear the unit, where vibration and noise are not increased.
- Place, where discharged wind and noise do not cause a nuisance to the neighbors.
- Place, where a distance marked ↔ is available as illustrated in the above figure.

Drawing for the installation of indoor and outdoor units

The models adopt HFC free refrigerant R32

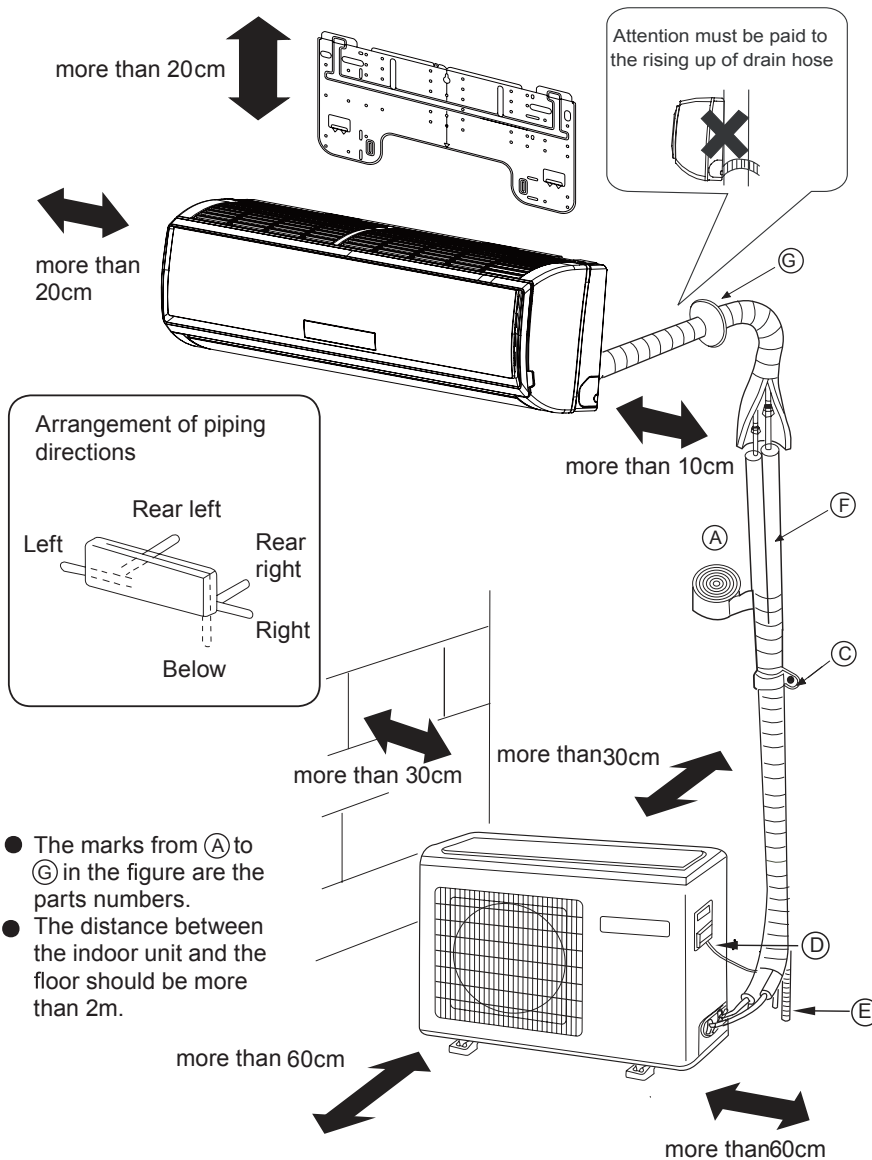

Accessory parts

No.	Accessory parts	Number of articles
①	Remote controller	1
②	R-03 dry battery	2
③	Mounting plate	1
④	Drain hose	1
⑤	φ4X25 Screw Plastic cap	4
⑥	Cover	1
⑦	Cushion	4
⑧	Connecting cable	1

Note:

1. Cooling only units don't have Drain-elbow
2. Accessory parts may vary from each model, please refer to the actual parts.

Necessary parts for piping

- (A) Non-adhesive tape
- (B) Adhesive tape
- (C) Saddle (L.S) with screws
- (D) Connecting electric cable for indoor and outdoor
- (E) Drain hose
- (F) Heating insulating material
- (G) Piping hole cover

Please be subject to the actual product purchased, the above picture is just for your reference.

Read this manual before installation
Explain sufficiently the operating means to the user according to this manual

<p>Floor fixing dimensions of the outdoor unit (Unit:mm)</p> <p>1U09BYFSRA 1U12BYFSRA</p>	<p>Floor fixing dimensions of the outdoor unit (Unit:mm)</p> <p>1U09JACFRA 1U12JACFRA 1U26JACFRA 1U35JACFRA</p>
<p>Floor fixing dimensions of the outdoor unit (Unit:mm)</p> <p>1U18RABFRA 1U53RABFRA</p>	<p>Floor fixing dimensions of the outdoor unit (Unit:mm)</p> <p>1U24SABFRA 1U71SABFRA</p>

Selection of pipe

FOR 09K 12K	Liquid pipe	ϕ 6.35x0.8mm
	Gas pipe	ϕ 9.52x0.8mm
FOR 18K	Liquid pipe	ϕ 6.35x0.8mm
	Gas pipe	ϕ 12.7x0.8mm
FOR 24K	Liquid pipe	ϕ 6.35x0.8mm
	Gas pipe	ϕ 12.7x0.8mm

Indoor unit

1 Fitting of the Mounting Plate and Positioning of the wall Hole

When the mounting plate is first fixed

- Carry out, based on the neighboring pillars or lintels, a proper leveling for the plate to be fixed against the wall, then temporarily fasten the plate with one steel nail.
- Make sure once more the proper level of the plate, by hanging a thread with a weight from the central top of the plate, then fasten securely the plate with the attachment steel nail.
- Find the wall hole location A using a measuring tape

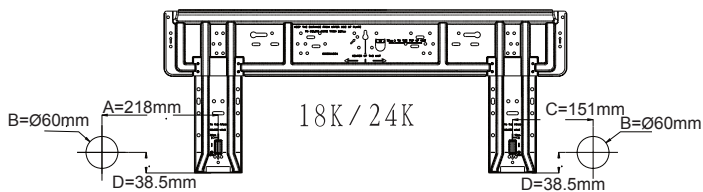
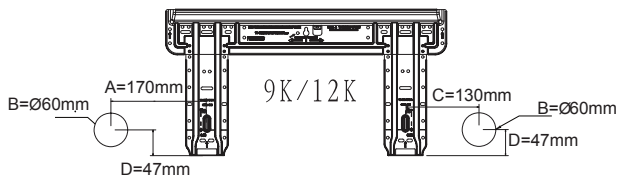

When the mounting plate is fixed side bar and lintel

- Fix to side bar and lintel a mounting bar, Which is separately sold, and then fasten the plate to the fixed mounting bar.
- Refer to the previous article, " When the mounting plate is first fixed ", for the position of wall hole.

2 Making a Hole on the Wall and Fitting the Piping Hole Cover

- Make a hole of 60 mm in diameter, slightly descending to outside the wall.
- Install piping hole cover and seal it off with putty after installation

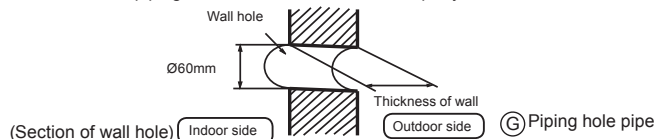

3 Installation of the Indoor Unit

Drawing of pipe

[Rear piping]

- Draw pipes and the drain hose, then fasten them with the adhesive tape

[Left · Left-rear piping]

- In case of left side piping, cut away, with a nipper, the lid for left piping.
- In case of left-rear piping, bend the pipes according to the piping direction to the mark of hole for left-rear piping which is marked on heat insulation materials.

- Insert the drain hose into the dent of heat insulation materials of indoor unit.
- Insert the indoor/outdoor electric cable from backside of indoor unit, and pull it out on the front side, then connect them.
- Coat the flaring seal face with refrigerant oil and connect pipes.
Cover the connection part with heat insulation materials closely, and make sure fixing with adhesive tape

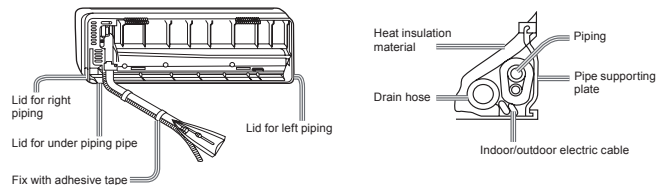

- Indoor/outdoor electric cable and drain hose must be bound with refrigerant piping by protecting tape.

[Other direction piping]

- Cut away, with a nipper, the lid for piping according to the piping direction and then bend the pipe according to the position of wall hole. When bending, be careful not to crash pipes.
- Connect beforehand the indoor/outdoor electric cable, and then pull out the connected to the heat insulation of connecting part specially.

Fixing the indoor unit body

- Hang surely the unit body onto the upper notches of the mounting plate. Move the body from side to side to verify its secure fixing.
- In order to fix the body onto the mounting plate, hold up the body aslant from the underside and then put it down perpendicularly.

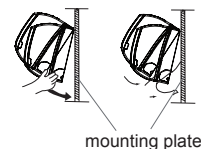

Unloading of indoor unit body

- When you unload the indoor unit, please use your hand to arise the body to leave agraffe, then lift the bottom of the body outward slightly and lift the unit aslant until it leaves the mounting plate.

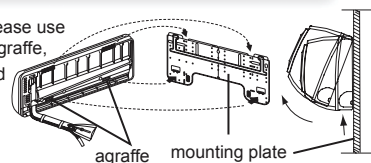

4 Connecting the indoor/outdoor Electric Cable

Removing the wiring cover

- Remove terminal cover at right bottom corner of indoor unit, then take off wiring cover by removing its screws.

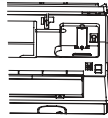

When connecting the cable after installing the indoor unit

1. Insert from outside the room cable into left side of the wall hole, in which the pipe has already existed.
2. Pull out the cable on the front side, and connect the cable making a loop.

When connecting the cable before installing the indoor unit

- Insert the cable from the back side of the unit, then pull it out on the front side.
- Loosen the screws and insert the cable ends fully into terminal block, then tighten the screws.
- Pull the cable slightly to make sure the cables have been properly inserted and tightened.
- After the cable connection, never fail to fasten the connected cable with the wiring cover.

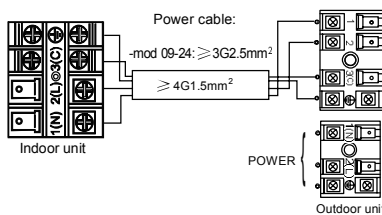

Note:

When connecting the cable, confirm the terminal number of indoor and outdoor units carefully. If wiring is not correct, proper operation can not be carried out and will cause defect.

Connecting wiring $\geq 4G1.0mm^2$

1. If the supply cord is damaged, it must be replaced by the manufacturer or its service agent or a similar qualified person. The type of connecting wire is H05RN-F or H07RN-F.
2. If the fuse on PC board is broken please change it with the type of T. 3.15A/250V.
3. The wiring method should be in line with the local wiring standard.
4. After installation, the power plug should be easily reached.
5. A breaker should be incorporated into fixed wiring. The breaker should be all-pole switch and the distance between its two contacts should be not less than 3mm.
6. Please consult your reseller and/or installer to determine if you have a DRED appliance. Connect output from your home's electricity power meter (where available) to the RJ45 connector on the outdoor unit, as shown. (This function is unavailable on some models.)

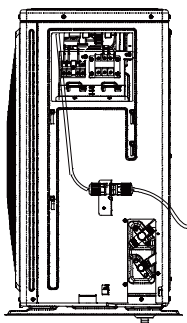

Outdoor unit

1 Installation of Outdoor Unit

Install according to Drawing for the installation of indoor and outdoor units

2 Connection of pipes

- To bend a pipe, give the roundness as large as possible not to crush the pipe, and the bending radius should be 30 to 40 mm or longer.
- Connecting the pipe of gas side first makes working easier.
- The connection pipe is specialized for R410A.

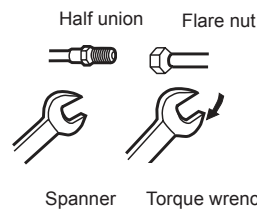

Forced fastening without careful centering may damage the threads and cause a leakage of gas.

Pipe Diameter(φ)	Fastening torque
Liquid side 6.35mm(1/4")	18N.m
Liquid/Gas side 9.52mm(3/8")	42 N.m
Gas side 12.7mm(1/2")	55N.m
Gas side 15.88mm(5/8")	60 N.m

Be careful that matters, such as wastes of sands, etc. shall not enter the pipe. The standard pipe length is 5m. If it is over 7m, the function of the unit will be affected. If the pipe has to be lengthened, the refrigerant should be charged, according to 20 g/m. But the charge of refrigerant must be conducted by professional air conditioner engineer. Before adding additional refrigerant, perform air purging from the refrigerant pipes and indoor unit using a vacuum pump, then charge additional refrigerant.

CAUTION

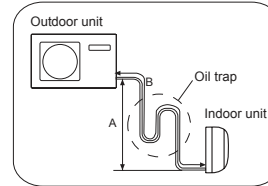
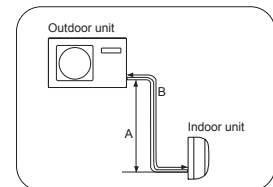
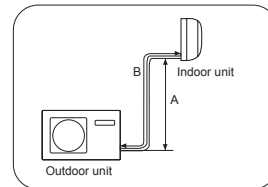

- Max. Elevation:
05-13K: Amax=10m
18-24K: Amax=15m
- In case the elevation A is more than 5m, oil trap should be installed every 5~7m
- Max. Length:
05-13K: Bmax=15m
18-24K: Bmax=25m
- In case the pipe length B is more than 7m, the refrigerant should be charged, according to 20 g/m for 05-13K and 50g/m for 18-24K.

3 Connection

- Use the same method on indoor unit. Loosen the screws on terminal block and insert the plugs fully into terminal block, then tighten the screws.
- Insert the cable according to terminal number in the same manner as the indoor unit.
- If wiring is not correct, proper operation can not be carried out and controller may be damaged.
- Fix the cable with a clamp.

4 Attaching Drain-Elbow

- If the drain-elbow is used, please attach it as figure. (Note: Only for heat pump unit.)

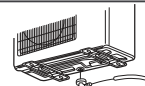

5 Purging Method: To use vacuum pump

1. Detach the service port's cap of 3-way valve, the valve rod's cap for 2-way valve and 3-way's, connect the service port into the projection of charge hose (low) for gaugemanifold. Then connect the projection of charge hose (center) for gaugemanifold into vacuum pump.
2. Open the handle at low in gaugemanifold, operate vacuum pump. If the scale-moves of gauge (low) reach vacuum condition in a moment, check 1. again.
3. Vacuumize for over 15min. And check the level gauge which should read -0.1MPa (76 cm Hg) at low pressure side. After the completion of vacuumizing, close the handle 'Lo' in gaugemanifold and stop the operation of the vacuum pump. Check condition of the scale and hold it for 1-2min. If the scale-moves back in spite of tightening, make flaring work again, the return to the beginning of 3.
4. Open the valve rod for the 2-way valve to an angle of anticlockwise 90 degrees. After 6 seconds, close the 2-way valve and make the inspection of gas leakage.

5. No gas leakage?

In case of gas leakage, tighten parts of pipe connection. If leakage stops, then proceed 6. steps

If it does not stop gas leakage, discharge whole refrigerants from the service port. After flaring work again and vacuumize, fill up prescribed refrigerant from the gas cylinder.

6. Detach the charge hose from the service port, open 2-way valve and 3-way. Turn the valve rod anticlockwise until hitting lightly.

7. To prevent the gas leakage, turn the service port's cap, the valve rod's cap for 2-way valve and 3-way's a little more than the point where the torque increases suddenly.

8. After attaching the each caps, check the gas leakage around the caps.

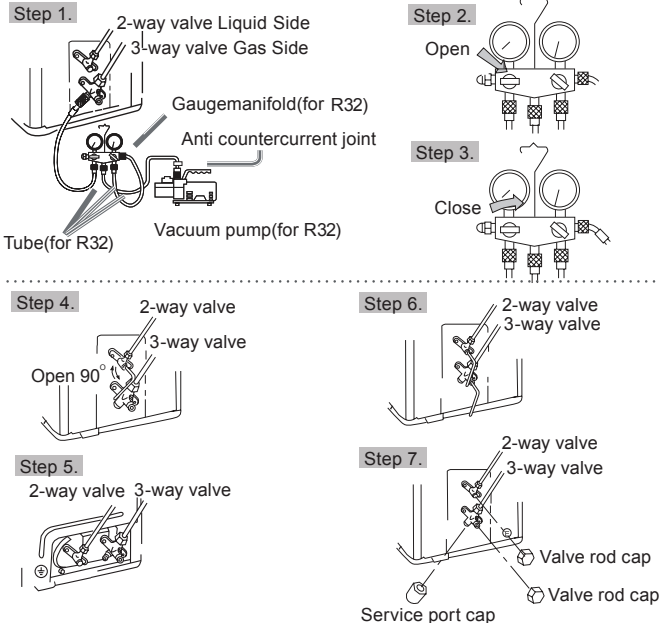

CAUTION

- If the refrigerant of the air conditioner leaks, it is necessary to discharge all the refrigerant. Vacuumize first, then charge the liquid refrigerant into air conditioner according to the amount marked on the name plate.
- Please do not let other cooling medium, except specified one (R32), or air enter into the cooling circulation system. Otherwise, there will be abnormal high pressure in the system to make it crack and lead to personal injuries.

1 Power Source Installation

- The power source must be exclusively used for air conditioner. (Over 10A)
- In the case of installing an air conditioner in a moist place, please install an earth leakage breaker.
- For installation in other places, use a circuit breaker as far as possible.

2 Cutting and Flaring Work of Piping

- Pipe cutting is carried out with a pipe cutter and burs must be removed.
- After inserting the flare nut, flaring work is carried out.

Flare tool for R32	Conventional flare tool	
	Clutch-type	Wing-nut type (Imperial-type)
A	0~0.5mm	1.0~1.5mm

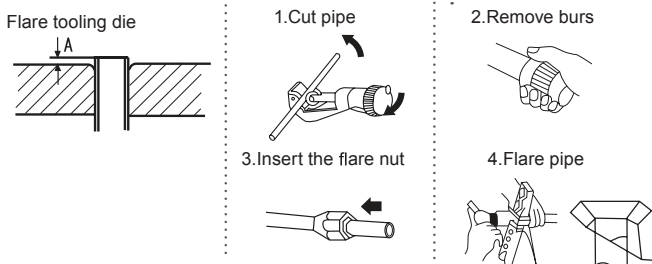

Correct	Incorrect				
	Lean	Damage of flare	Crack	Partial	Too outside

3 On Drainage

- Please install the drain hose so as to be downward slope without fail.
- Please don't do the drainage as shown below.

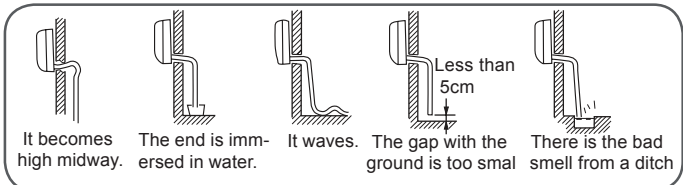

- Please pour water in the drain pan of the indoor unit, and confirm that drainage is carried out surely to outdoor.
- In case that the attached drain hose is in a room, please apply heat insulation to it without fail.

Refrigerant charge label

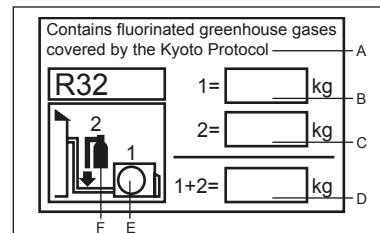

This product contains fluorinated greenhouse gases covered by the Kyoto Protocol. Do not vent into the atmosphere.

Refrigerant type: R32

GWP* value: 675

GWP=global warming potential

Please fill in with indelible ink,

- 1 the factory refrigerant charge of the product
- 2 the additional refrigerant amount charged in the field and
- 1+2 the total refrigerant charge

on the refrigerant charge label supplied with the product. The filled out label must be adhered in the proximity of the product charging port (e.g. onto the inside of the stop valve cover).

A contains fluorinated greenhouse gases covered by the Kyoto Protocol

B factory refrigerant charge of the product: see unit name plate

C additional refrigerant amount charged in the field

D total refrigerant charge

E outdoor unit

F refrigerant cylinder and manifold for charging

Check for Installation and Test Run

- Please kindly explain to our customers how to operate through the instruction manual.

Check Items for Test Run

Put check mark ✓ in boxes

- Gas leak from pipe connecting?
- Heat insulation of pipe connecting?
- Are the connecting wirings of indoor and outdoor firmly inserted to the terminal block?
- Is the connecting wiring of indoor and outdoor firmly fixed?
- Is drainage securely carried out?
- Is the earth line securely connected?
- Is the indoor unit securely fixed?
- Is power source voltage abided by the code?
- Is there any noise?
- Is the lamp normally lighting?
- Are cooling and heating (when in heat pump) performed normally?
- Is the operation of room temperature regulator normal?