



MODELS

GHS607S/W, GHC607S/W, GHC617S/W,
GHS917S/W, GHC937S/W, 72K315S/W, GHR12S/W,
GHR92S, WHG640SA/WA, CHG642SA/WA,
CHG646SA/WA, CHG956SA/WA, CHG606SA,
SHG646SA, SHG956SA, WHG641SA, WHG643SA,
WHG645SA/WA, WHG951SA, WHG955SA/WA

CONGRATULATIONS

Congratulations and thank you for choosing our Gas Cooktop. We are sure you will find your new appliance a pleasure to use and a great asset to your cooking. Before you use the appliance, we recommend that you read through the whole user manual which provides a description of the product and its functions.

To avoid the risks that are always present when you use a cooking appliance, it is important that the appliance is installed correctly and that you read the safety instructions carefully to avoid misuse and hazards. For future reference, please store this booklet in a safe place. This appliance complies to the requirements of Australian Standard AS4551.

CONDITIONS OF USE

This appliance is intended to be used in household and similar applications such as:

- Staff kitchen areas in shops, offices and other working environments
- Farm houses
- By clients in hotels, motels and other residential type environments
- Bed and breakfast type environments

Record model and serial number here:

Model:

Serial number:

The symbols you will see in this booklet have these meanings:

warning

Indicates information concerning your personal safety

caution

Indicates information on how to avoid damaging the appliance

tips & information

Indicates tips and information about use of the appliance

environmental tips

Indicates tips and information about economical and ecological use of the appliance

tips & information

Important – check for any damage or marks

If you find the appliance is damaged or marked, you must report it within 7 days if you wish to claim for damage/marks under the manufacturer's warranty. This does not affect your statutory rights.

environmental tips

Information on disposal for users

- Most of the packing materials are recyclable. Please dispose of those materials by contacting your local authorities and ask for the correct method of disposal.

CONTENTS

General safety	3
Using your cooktop	4
Cleaning and care	5
Troubleshooting	6
Technical data	7
Installation	11
LPG conversion - Dong Yang Regulator	13
LPG conversion - Chant Regulator	15
Electrical connection.....	16
Testing appliance operation	17
Warranty	19

general safety

Read the following carefully to avoid an electric shock or fire

General warnings

- This appliance is not intended for use by persons (including children) with reduced physical, sensory or mental capabilities, or lack of experience and knowledge, unless they have been given supervision or instruction concerning use of the appliance by a person responsible for their safety.
- Young children should be supervised to ensure they do not play with this appliance.
- During use this appliance becomes hot. Care should be taken to avoid touching hot external and internal surfaces when in use. Use oven gloves. Children should be kept away to avoid burns and scalds.
- This appliance must NOT be used as a space heater.
- Keep vents clear of obstructions.
- In order to avoid a fire, the appliance must be kept clean.
- Do not spray aerosols in the vicinity of the appliance when it is in operation.
- Do not store flammable materials in or under the appliance, eg. aerosols.
- Do not modify this appliance.

Cooktops (generally)

- Do not allow pots to boil dry, as damage to both pan and cooktop may result.
- Do not operate the cooktop for an extended period of time without a pot or pan on the hotplate.
- Do not allow large cookware to overhang the cooktop onto the adjacent benchtop. This will cause scorching to the benchtop surface.
- Do not allow cooking pots or pans to intrude into the area which is close to the controls.
- Ensure burner caps and trivets are properly located. (see Figure 1)
- For maximum stability, ensure pots and pans are centrally located on the trivets.
- Handles should be turned away from the front of the bench to avoid accidents.
- Only models fitted with flame safeguard can be used in marine craft, caravans or mobile homes.

Figure 1

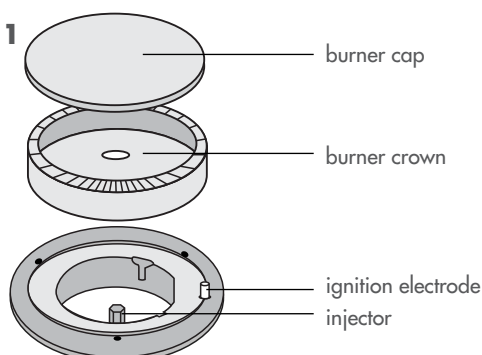

NOTE: You must read these warnings carefully before installing or using the cooktop. If you need assistance, contact your Customer Care Department. The manufacturer will not accept liability should the instructions below, or any other safety instructions incorporated in this book, be ignored.

Installation

- An authorised person must install this appliance and MUST provide a certificate of compliance.
- Before using the appliance, ensure that all packing materials are removed from the appliance.
- In order to avoid any potential hazard, the installation instructions in this booklet and any label on the appliance, must be followed.
- Ensure that all specified vents, openings and air spaces are not blocked.
- Where the appliance is built into a benchtop, the benchtop material must be capable of withstanding temperatures of 85°C.
- DO NOT install in marine craft, caravans or mobile homes because these products are not fitted with a flame safeguard on each burner.

Servicing

- Servicing MUST only be carried out by authorised personnel.
- To maintain safe operation, it is recommended that the product be inspected every five years by an authorised service person.
- For appliances supplied with a supply cord, if the supply cord is damaged it must be replaced by an authorised service person in order to avoid a hazard.
- For models with battery ignition, the battery will require periodic replacement (see page 12).

NOTE: The battery is a perishable item and is not covered by the warranty.

Cleaning

- Always ensure the appliance is turned off before cleaning.
- This appliance contains aluminium fittings. DO NOT use caustic based cleaners.
- Do not use steam cleaners as this may cause moisture build-up on electrical components.
- Always clean the appliance immediately after any food spillage.
- DO NOT place burner caps, crowns or griddle plate in a dishwasher.

using your cooktop

warning

DO NOT spray aerosols in the vicinity of this appliance while it is in operation as aerosols can contain flammable propellants.

warning

Where the appliance is installed in any confined area, the area must be properly ventilated. It MUST NOT be used as a space heater.

Controls

Each burner is controlled by a control knob. The markings on the control panel indicate which burner the knob controls, and the settings for that burner (see Figure 2).

Figure 2

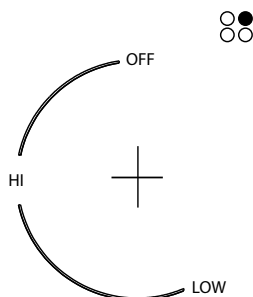

Lighting burners

Electronic ignition: These cooktops are fitted with mains powered or battery ignition. When the appliance has been connected and the power is on, depressing any knob will release sparks to all burners (except push button ignition, see push button ignition models). To light a burner, depress the corresponding knob and turn to the 'HIGH' position (while depressing the knob). The knob may be released once the flame is established.

Flame safeguard models

The knob must be turned to the 'High' position, then pushed down as far as possible for approximately 5 seconds. If the flame goes out when the knob is released, simply depress the knob again, this time holding it down with slightly more force for the same length of time. The height of the flame can be varied by turning the control knob toward the "Low" position.

Push button ignition: Turn the knob to the 'HIGH' position and press the ignition button down until the flame is established. The height of the flame can be varied by turning the knob towards the 'LOW' position.

warning

Keep hands clear of the burners when lighting.

If the burner does not light within 5 seconds, turn knob to 'OFF' position, allow gas to disperse then try lighting again.

caution

Burners MUST be operated between 'HIGH' and 'LOW' settings only. In the absence of electrical power, carry out the ignition directly to the burner with a hand held ignition source.

Hotplates

Choice of hotplate

For your convenience there is a choice of hotplates:

- A small burner for special low heat and slow cooking.
- A medium burner for normal cooking and simmering.
- A large burner for fast heating and large pots and pans.
- A wok burner for very fast heating using a wok or large pot or pan.

To conserve gas place the pan centrally over the burner and adjust the flame so that it does not extend past the edge of the pan (Figure 3). Do not boil food too rapidly. A vigorous boil will not cook food any faster, and will waste energy.

Pots and pans

All common pots and pans; aluminium, stainless steel, cast iron, ceramic, etc., may be used on your new gas cooktop. Ensure that the pots or pans are steady and have flat bases to avoid dangerous spill-over of hot liquids and wasted energy.

Figure 3

Choice of flame height

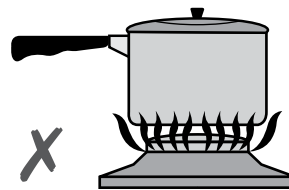

Incorrect – flame too high and will cause gas waste and possible handle damage.

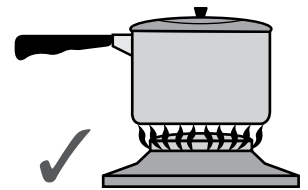

Correct flame height. Gas saved.

Choice of cooking utensils

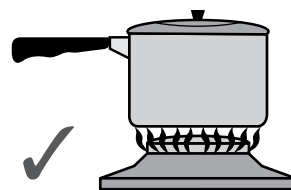

For a large burner, use a large utensil.

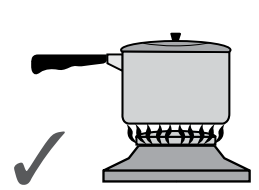

For a small burner, use a small utensil.

caution

Never use asbestos mats, wire mats or grids, or aluminium foil as it can lead to overheating, cracked enamel or broken glass. The warranty will be void if these items are used and cause a failure. Woks should only be used on the wok burner and wok support trivet.

cleaning and care

warning

Ensure the appliance is off and cool before cleaning.

Enamel

Persistent stains may require rubbing with a nylon scourer or creamed powder cleansers. Household enamel cleaners are available, follow the manufacturer's instructions in their use. Harsh abrasive cleaners, powder cleaners, steel wool or wax polishes should not be used.

Stainless steel

NOTE: Ensure any oil is cleaned off the hob before use, otherwise it may cause the hob to turn a yellowish colour.

All grades of stainless steel may stain, discolour or attain an adhering layer of grime in normal operation. To achieve maximum surface appearance, stainless steel must be kept clean by regularly using the following cleaning procedures. Wash with warm soapy water and rinse with clean water. Where the stainless steel has become extremely dirty with signs of surface discolouration, (due to periods of neglect or misuse) use a stainless steel cleaner. When removing these stains, be sure to follow the polish or brushing lines.

caution

DO NOT use abrasive scourers or steel wool.

Trivets, burner caps and crowns

These can all be lifted off and removed for separate cleaning.

NOTE: When re-fitting the burner caps and crowns, ensure that they are correctly seated.

Ensure burners are thoroughly dried after cleaning or spillage. When cleaning the burners, ensure that all the flame ports are free of any blockage (refer to Figure 1b on page 4). If necessary, use a toothpick or brush to clear ports. The outer surface of the burner caps have a polished finish and extra care needs to be taken to avoid scratching this surface during cleaning. In instances of heavy soiling, it may be necessary to apply a non-abrasive cleaning compound and rub with a cloth until the soiling is removed and then finish with a soft, dry cloth.

caution

DO NOT place trivets or burners in the dishwasher.

Ignition electrode

GENTLY clean the ignition spark plug and flame safeguard sensor with a damp cloth to avoid lighting difficulties. Ensure that they are dry before use.

Injector

Ensure the injector remains free of any foreign material. If necessary, use a thin piece of wire to clear the orifice.

troubleshooting

If you have a problem with the cooktop, check the table below. You may be able to solve the problem and this will save you from paying for a service call. You will have to pay for a service call even in the warranty period if the problem is one listed below.

Table 1

problem	possible cause	solution
Burner will not light even though the sparker is working	Gas supply valve turned off	Turn on gas supply to appliance
	Control knob not on	Turn knob on (refer to page 3)
	Wrong knob turned	Ensure the knob you are turning corresponds to the burner you want to light
	Knob not held down long enough in 'High' position for flame safeguard (where fitted) to engage	Repeat lighting procedure and hold knob down for 5 seconds in 'High' position (refer page 4)
	Port blockage in ignition area	Ensure that ports in ignition area are clean and dry
	Ignition electrode wet or dirty	Dry or clean ignition electrode
	Sparking at wrong point because of incorrectly fitted burner crown	Ensure that the crown is seated properly so that the spark fires to the receiving point in the burner crown (refer to Figure 1)
	Injector is blocked	Ensure injector is clear of foreign material
No spark is obtained when control knob is activated	Electricity supply is disconnected or switched off	Switch on electricity or check fuses
	Battery is flat	Replace battery (refer to page 12)
	Polarity wrong on battery	Reorient battery to correct position (refer to page 12)
	Ignition electrode wet or dirty	Dry or clean ignition electrode
Flames uneven or tending to lift	Flame ports blocked or wet	Clean or dry flame ports
	Burner cap/crown incorrectly fitted	Ensure these components are fitted correctly
Flames not staying on when knob is released	Knob not set between 'HIGH' and 'LOW'	Knob MUST be set between these positions
	Knob not held down long enough in 'High' position for flame safeguard (where fitted) to engage	Repeat lighting procedure and hold knob down for 5 seconds in 'High' position (refer page 4)
Low heat, slow cooking	Incorrect cooking pot or pan being used	Refer to Figure 3 (page 4)
Benchtop or knobs overheating	Incorrect cooking pot or pan used	Refer to Figure 3 (page 4)
	Pot or pan not located on burner properly	Ensure pot or pan is centrally located on burner
Cooktop stainless steel discoloured	Pot or pan being used is too large	Ensure pot sizes used are as per user manual requirements. Clean with STEEL POWER (available through spare parts)

If all the above points have been checked and there is still a problem with the cooktop please call the Service Centre.

technical data

FEATURES	GHS607S/W	GHC607S/W	GHC617S/W	GHS917S/W	GHC937S/W
Brand	Chef	Chef	Chef	Chef	Chef
Cooking zones	4	4	4	4	5
Wok	No	No	Yes	Yes	Yes
Ignition	1.5V battery	220-240V	220-240V	1.5V battery	220-240V
Trivet	Wire Gloss	Wire Gloss	Wire Gloss	Wire Gloss	Wire Gloss
Hob material	Stainless Steel/ Enamelled White	Stainless Steel/ Enamelled White	Stainless Steel/ Enamelled White	Stainless Steel/ Enamelled White	Stainless Steel/ Enamelled White
Features	Push button ignition	Ignition through knob	Ignition through knob	Push button ignition	Ignition through knob
Flame safeguard	No	No	No	No	No
Gas Types	NG, (LP conversion kit supplied)	NG, (LP conversion kit supplied)	NG, (LP conversion kit supplied)	NG, (LP conversion kit supplied)	NG, (LP conversion kit supplied)
Cooktop dimension					
Width (mm)	600	600	600	860	860
Depth (mm)	535	535	535	510	510
Height (mm)	58	58	58	58	58
Cutout dimension					
Width (mm)	570	570	570	830	830
Depth (mm)	490	490	490	470	470
Energy rating (NG)					
Small burner	5.1 MJ/h	5.1 MJ/h	5.1 MJ/h	5.1 MJ/h	5.1 MJ/h
Medium burner	2 x 9.0 MJ/h	2 x 9.0 MJ/h	2 x 9.0 MJ/h	9.0 MJ/h	2 x 9.0 MJ/h
Large burner	12.1 MJ/h	12.1 MJ/h		12.1 MJ/h	12.1 MJ/h
Wok burner			14.4 MJ/h	14.4 MJ/h	14.4 MJ/h
Total MJ/h	35.2 MJ/h	35.2 MJ/h	37.5 MJ/h	40.6 MJ/h	49.6 MJ/h

technical data

FEATURES	CHG642SA/WA	CHG646SA/WA	CHG956SA/WA	CHG606SA	72K315S/W
Brand	Chef	Chef	Chef	Chef	Simpson
Cooking zones	4	4	5	4	4
Wok	Yes	Yes	Yes	Yes	Yes
Ignition	1.5V battery	220-240V	220-240V	220-240V	220-240V
Trivet	Wire Gloss	Wire Matt	Wire Matt	Wire Matt	Wire Gloss
Hob material	Stainless Steel/ Enamelled White	Stainless Steel/ Enamelled White	Stainless Steel/ Enamelled White	Stainless Steel	Stainless Steel/ Enamelled White
Features	Ignition through knob	Ignition through knob	Ignition through knob	Ignition through knob	Ignition through knob
Flame safeguard	No	No	No	No	No
Gas Types	NG, (LP conversion kit supplied)	NG, (LP conversion kit supplied)	NG, (LP conversion kit supplied)	NG, (LP conversion kit supplied)	NG, (LP conversion kit supplied)
Cooktop dimension					
Width (mm)	600	600	860	600	600
Depth (mm)	535	535	510	535	535
Height (mm)	58	58	58	58	58
Cutout dimension					
Width (mm)	570	570	830	570	570
Depth (mm)	490	490	470	490	490
Energy rating (NG)					
Small burner	5.1 MJ/h	5.1 MJ/h	5.1 MJ/h	5.1 MJ/h	5.1 MJ/h
Medium burner	2 x 9.0 MJ/h	2 x 9.0 MJ/h	2 x 9.0 MJ/h	9.0 MJ/h	2 x 9.0 MJ/h
Large burner			12.1 MJ/h	12.1 MJ/h	
Wok burner	14.4 MJ/h	14.4 MJ/h	14.4 MJ/h	14.4 MJ/h	14.4 MJ/h
Total MJ/h	37.5 MJ/h	37.5 MJ/h	49.6 MJ/h	40.6 MJ/h	37.5 MJ/h

technical data

FEATURES	SHG646SA	SHG956SA	GHR12S/W	GHR92S	WHG640SA/WA
Brand	Simpson	Simpson	Westinghouse	Westinghouse	Westinghouse
Cooking zones	4	5	4	5	4
Wok	Yes	Yes	No	Yes	No
Ignition	220-240V	220-240V	220-240V	220-240V	220-240V
Trivet	Wire Matt	Wire Matt	Wire Matt	Wire Matt	Wire Matt
Hob material	Stainless Steel	Stainless Steel	Stainless Steel/ Enamelled White	Stainless Steel	Stainless Steel/ Enamelled White
Features	Ignition through knob	Ignition through knob	Ignition through knob	Ignition through knob	Ignition through knob
Flame safeguard	No	No	No	No	No
Gas Types	NG, (LP conversion kit supplied)	NG, (LP conversion kit supplied)	NG, (LP conversion kit supplied)	NG, (LP conversion kit supplied)	NG, (LP conversion kit supplied)
Cooktop dimension					
Width (mm)	600	860	600	860	600
Depth (mm)	535	510	535	510	535
Height (mm)	58	58	58	58	58
Cutout dimension					
Width (mm)	570	830	570	830	570
Depth (mm)	490	470	490	470	490
Energy rating (NG)					
Small burner	5.1 MJ/h	5.1 MJ/h	5.1 MJ/h	5.1 MJ/h	5.1 MJ/h
Medium burner	2 x 9.0 MJ/h	2 x 9.0 MJ/h	2 x 9.0 MJ/h	2 x 9.0 MJ/h	2 x 9.0 MJ/h
Large burner		12.1 MJ/h	12.1 MJ/h	12.1 MJ/h	12.1 MJ/h
Wok burner	14.4 MJ/h	14.4 MJ/h		14.4 MJ/h	
Total MJ/h	37.5 MJ/h	49.6 MJ/h	35.2 MJ/h	49.6 MJ/h	35.2 MJ/h

technical data

FEATURES	WHG641SA	WHG643SA	WHG645SA/WA	WHG951SA	WHG955SA/WA
Brand	Westinghouse	Westinghouse	Westinghouse	Westinghouse	Westinghouse
Cooking zones	4	4	4	5	5
Wok	Yes	Yes	Yes	Yes	Yes
Ignition	220-240V	220-240V	220-240V	220-240V	220-240V
Trivet	Wire Matt	Wire Matt	Cast Iron	Wire Matt	Cast Iron
Hob material	Stainless Steel	Stainless Steel	Stainless Steel/ Enamelled White	Stainless Steel	Stainless Steel/ Enamelled White
Features	Ignition through knob	Ignition through knob	Ignition through knob	Ignition through knob	Ignition through knob
Flame safeguard	No	Yes	Yes	No	Yes
Gas Types	NG, (LP conversion kit supplied)	NG, (LP conversion kit supplied)	NG, (LP conversion kit supplied)	NG, (LP conversion kit supplied)	NG, (LP conversion kit supplied)
Cooktop dimension					
Width (mm)	600	600	600	860	860
Depth (mm)	535	535	535	510	510
Height (mm)	58	58	58	58	58
Cutout dimension					
Width (mm)	570	570	570	830	830
Depth (mm)	490	490	490	470	470
Energy rating (NG)					
Small burner	5.1 MJ/h	5.1 MJ/h	5.1 MJ/h	5.1 MJ/h	5.1 MJ/h
Medium burner	9.0 MJ/h	9.0 MJ/h	9.0 MJ/h	2 x 9.0 MJ/h	2 x 9.0 MJ/h
Large burner	12.1 MJ/h	12.1 MJ/h	12.1 MJ/h	12.1 MJ/h	12.1 MJ/h
Wok burner	14.4 MJ/h	14.4 MJ/h	14.4 MJ/h	14.4 MJ/h	14.4 MJ/h
Total MJ/h	40.6 MJ/h	40.6 MJ/h	40.6 MJ/h	49.6 MJ/h	49.6 MJ/h

installation

Table 2

Cooktop dimensions	Square	Rectangular
width (mm)	600	860
depth (mm)	535	510
height (mm)	58	58
Cut-out dimensions		
width (mm)	570	830
depth (mm)	490	470

caution

Cooktops are supplied for use with natural gas (NG). To use with LPG, the injectors **MUST** be changed using the conversion kit supplied. Refer LP Conversion on page 13 and 15).

This appliance must be installed by an authorised person and in compliance with:

1. AS/NZS 5601.1 Gas Installations Part 1: General Installations, and AS/NZS 5601.2 Gas Installations Part 2: LP Gas installations in caravans and boats for non-propulsive purposes, or the relevant installation code for gas appliances in your country.
2. The local gas fitting regulations, municipal building codes, electrical wiring regulations and any other relevant statutory regulations.
3. The particular instructions as given below. Before commencing installation, check to ensure that the appliance gas type given on the data plate on the appliance corresponds with the type of gas to which it is intended the appliance be connected.
4. A certificate of compliance **MUST** be given to the customer after the application is successfully installed.
5. This appliance must be earthed (240V models only).

Installation procedure

1. The bench cutout should be made as per cutout dimensions in Table 2 and Figure 4.
2. Adjacent walls, cupboards and protection for combustible materials: Ensure that the appliance is installed in accordance with clauses 6.2.5 and 6.10.1.1 of AS/NZS 5601.1, or clauses 6.9.1 and 6.9.5 of AS/NZS 5601.2 with regard to clearances to combustible surfaces and materials, and clearances to rangehoods and exhaust fans.

To ensure clearances of 200mm from burners to vertical combustible surfaces observe the minimum distance requirements shown in Figure 5.

Clearances to combustible surfaces may be reduced if combustible surfaces are protected in accordance with clause 6.10.1.2 of AS/NZS 5601.1, or clause 6.9.2 of AS/NZS 5601.2.

NOTE: For installation into a standard 600mm width benchtop the clearance specified can not be achieved and combustible surfaces must be protected in accordance with the above clauses.

3. **Optional barrier:** A barrier can be installed to prevent accidental contact with the cooktop base, where the base of the cooktop is accessible from below (i.e. Inside a cupboard, etc.). An impression has been incorporated into the base to ensure a minimum clearance of 10mm is maintained between the base and the barrier. This barrier may be made of any rigid material.

Barrier protection is not necessary if the product is installed above an underbench oven or similar appliance and/or if the cupboard construction is such that the underside of the cooktop is not accessible.

Figure 4

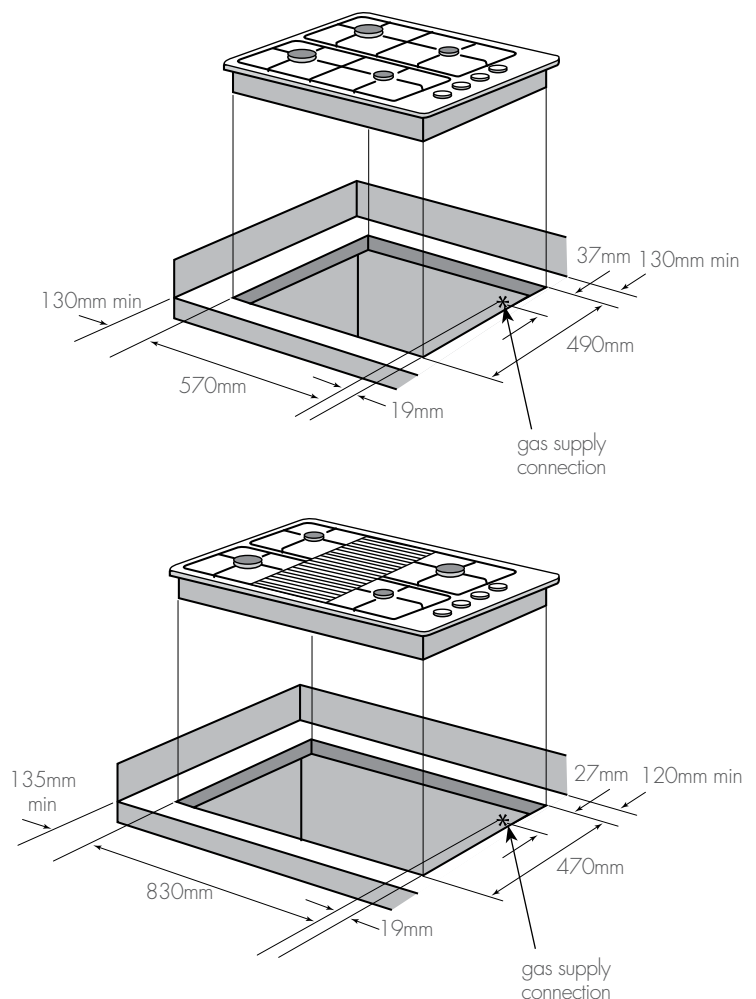

installation

Figure 5

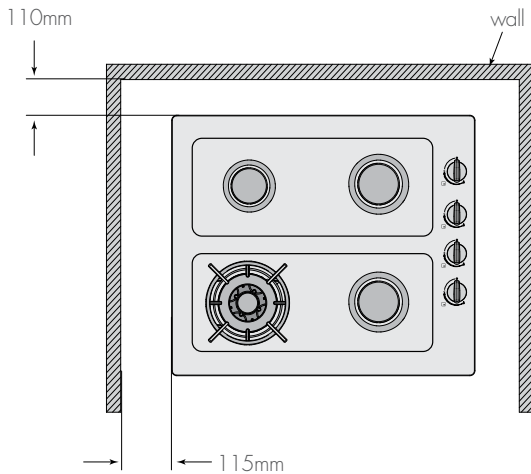

4. **Fitting the cooktop into the bench.** Carry out as follows.

- Place the rubber seal provided around the edge of the hob.

NOTE: The rubber seal has talc powder applied to its surface which should be wiped off with a damp cloth after the unit has been installed.

Figure 6

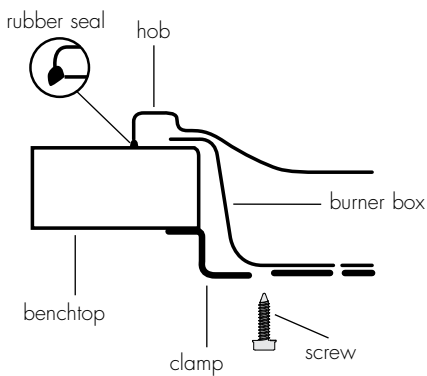

- Fit the pull-down clamps supplied to ensure that the cooktop cannot move after installation.

⚠ warning

Failure to fix the cooktop to the bench could result in loosening of the gas connection through movement of the cooktop and a gas leak may result.

- Use the 4 clamps and 4 screws supplied in the parts bag.
- To assemble, attach the 4 clamps to each corner of the burner box via the screw provided.
- When placing the cooktop in the cut-out, swing the clamps parallel with the box to avoid interference with the cut-out.
- Position the cooktop so it is centred, then swing the clamps under the benchtop and tighten.

Operation on NG/SNG

Regulator

An appliance regulator is provided. The regulator must be positioned so that the pressure test nipple is accessible when the appliance is installed. Connect the gas supply to the 1/2" B.S.P. internal thread inlet of the regulator. Refer to 'bench cutout' (Figure 4) for connection point position.

Regulators are supplied pre-adjusted and configured by the component maker for use with Natural Gas. The appliance installer is not required to make an adjustment to obtain the correct outlet pressure setting.

An arrow on the base of the regulator indicates the direction of gas flow when the inlet and outlet of the regulator is oriented correctly. When the regulator has been fitted check for leaks from the connections with soapy water.

Gas connection

This appliance is supplied for use with Natural Gas.

However, it can be converted for use with LPG. Refer to LP conversion on pages 13-15.

Supply pipe sizing

The total hourly gas consumption for the appliance is shown on the data label. The required supply pressure (i.e. at inlet to appliance regulator) for each gas type is shown on the data label, and given in Table 3. Use this information in conjunction with the length of run, number of elbows, tees and bends, the available service pressure and the supply requirements of other installed appliances to determine a suitable pipe size. For assistance in this matter refer to the appropriate section of AS/NZS 5601.1 or AS/NZS 5601.2.

An AGA certified class B or D flexible connection may be used to connect the cooktop in accordance with AS/NZS 5601.1, in particular section 5.9 and clause 6.10.1.8, or AS/NZS 5601.2, in particular section 2.11. Where a hose assembly is used and the cooktop is in the installed position, the hose assembly shall be suitable for connection to a fixed consumer piping outlet located at a point 800 – 850mm above the floor and in the region outside the width of the appliance to a distance of 250mm. The point of connection to consumer piping must be accessible with appliance installed.

Elbow positioning

It is possible to reposition the elbow if required by loosening the locking nut and elbow by using two spanners. Re-tighten the entire assembly after the elbow has been repositioned. When fitting elbow to appliance, ensure that the sealing washer is fitted.

installation

Checking the gas supply

1. Check the manometer zero point is correct.
2. Connect the manometer to the cooktop pressure point. This is located on the regulator.
3. Turn on the gas supply and electricity and try to ignite the gas.

i tips & information

It will take additional time to light the gas for the first time as air needs to be purged from the pipes.

4. With the appliance operating check the outlet pressure:
 - when all burners of the appliance are operating at maximum,
 - when the smallest burner of the appliance is operating at minimum.

Under these conditions the outlet pressure should not vary from the nominal outlet pressure of 1.00kPa by more than ± 0.20 kPa.

If the regulator appears to not be performing satisfactorily, then check the following points.

1. If the outlet pressure is consistently too low then the inlet pressure may be too low and adjustment of an upstream regulator may be needed, or an upstream regulator or valve with insufficient flow capacity may be present in the gas supply line. If this is suspected then it may be necessary to repeat the checks whilst measuring both the inlet and outlet pressure to determine if the inlet pressure is in the range 1.13 – 5kPa.
2. Check that the regulator has been fitted to the gas supply line in the correct orientation, the arrow on the base of the body indicates the direction of gas flow.

Once these checks have been completed, if the regulator still fails to perform in a satisfactory manner it should be replaced.

LPG conversion - DONG YANG regulator

i tips & information

Refer to page 15 if you have been supplied with a CHANT regulator.

This appliance is fitted with Natural Gas burner injectors.

Please follow the procedure below if a conversion to suit LP gas is required. The conversion kit contains appropriate LPG injectors and 1 LPG sticker.

To convert to LPG

1. Remove the hotplate burners to access the hotplate injectors. Replace the factory fitted NG injectors with the appropriate injectors, as supplied (see Table 3).
2. Unscrew the hex nut from the regulator. The hex nut, brass washer and nylon insert will disengage as an assembly.
3. Unclip the nylon insert from the nut assembly by rotating the insert $\frac{1}{4}$ turn, and pulling it free.
4. Turn over the insert, and clip back into position.
5. Refit the hex nut assembly to the regulator ensuring that it is fully screwed down. The regulator is now set for connection to LP.
6. Turn on the gas supply and at each new connection check for leaks using soapy water: each hotplate valve should be turned on, one at a time, and the injector hole blanked off for several seconds.
7. The operation of the regulator can be confirmed by connecting a manometer to the pressure test point located on the side of the regulator body adjacent to the outlet. With the appliance operating check the outlet pressure
 - when all burners of the appliance are operating at maximum,
 - when the smallest burner of the appliance is operating at minimum.

Under these conditions the outlet pressure should not vary from the nominal outlet pressure of 2.60kPa by more than ± 0.52 kPa.

8. If the regulator appears to not be performing satisfactorily then check the following points.
 - If the outlet pressure is consistently too low then the inlet pressure may be too low and adjustment of an upstream regulator may be needed, or an upstream regulator or valve with insufficient flow capacity may be present in the gas supply line. If this is suspected then it may be necessary to repeat the checks whilst measuring both the inlet and outlet pressure to determine if the inlet pressure is in the range 2.75–7.00kPa.
 - Check that the insert has been fitted correctly as per diagram figure 7. Check that the hex nut is fully screwed down.

LPG conversion - DONG YANG regulator

- Check that the regulator has been fitted to the gas supply line in the correct orientation, the arrow on the base of the body indicates the direction of gas flow.

Once these checks have been completed, if the regulator still fails to perform in a satisfactory manner it should be replaced.

9. One by one, turn the knobs to minimum and screw in the bypass screw (accessible when the knob is removed – refer figure 11) until a small stable flame results. Turn the knob to maximum and then back to minimum to ensure that the correct minimum flame is maintained.
10. Attach the LPG sticker to the cooker, near the gas supply inlet. Cover the Natural Gas label that is factory fitted.

Table 3

BURNER TYPE	NATURAL GAS (Nominal test point pressure: 1.00kPa)		LPG (Nominal test point pressure: 2.60kPa)	
	Injector size (mm)	Gas consumption (MJ/h)	Injector size (mm)	Gas consumption (MJ/h)
Small burner	1.00	5.1	0.55	4.0
Medium burner	1.35	9.0	0.70	6.5
Large burner	1.60	12.1	0.90	10.7
Wok burner	1.75	14.4	1.00	13.0

Figure 7

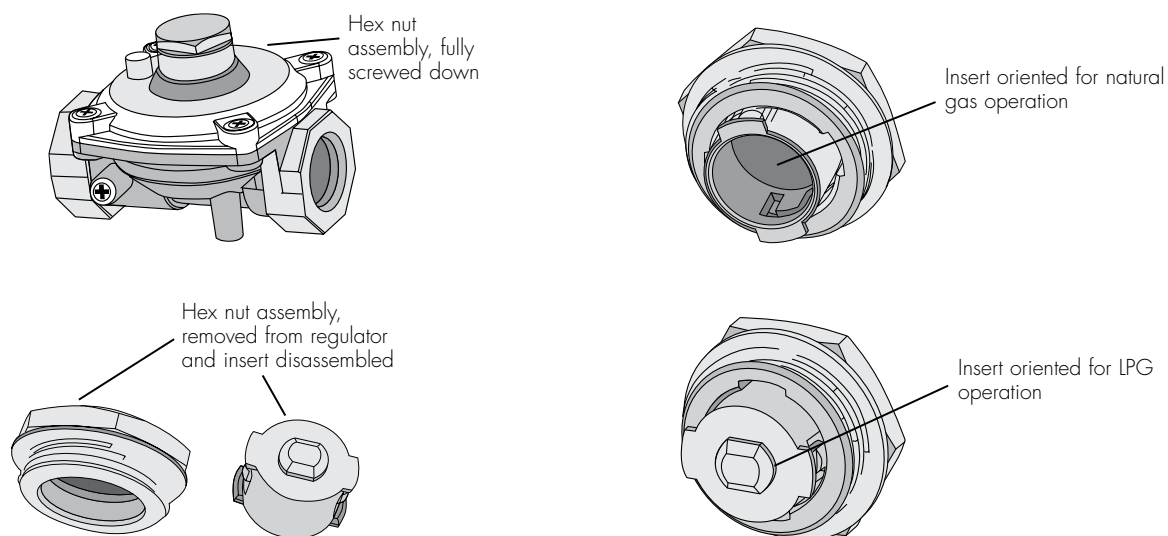

LPG conversion - CHANT regulator

i tips & information

Refer to page 13-14 if you have been supplied with a DONG YANG regulator.

This appliance is supplied set up for Natural Gas usage. A conversion kit is included with the product for Universal LPG usage. The conversion kit contains the appropriate injectors and 1 LPG sticker.

Please follow the procedure below if a conversion to suit UNIVERSAL LPG is required:

1. Remove the hotplate trivets, burner caps and burner crowns to access the hotplate injectors. Replace the factory fitted injectors with the appropriate injectors, as supplied. Refer to injector orifice table for injector sizes. The injector size is stamped on the side of the injector.
 2. Unscrew the top hat nut from the regulator. The top hat nut and control pressure spring assembly will disengage as an assembly.
 3. Unscrew the threaded pin from top hat.
 4. Upright threaded pin, so spring is free and screw pin back into the top hat until firm.
 5. Refit the top hat nut assembly to the regulator ensuring that it is fully screwed down. The regulator is now set for connection to LPG.
 6. Turn on the gas supply and at each new connection check for leaks using soapy water. Each hotplate valve should be turned on, one at a time, and the injector hole blanked off for several seconds.
 7. The operation of the regulator can be confirmed by connecting a manometer to the pressure test point located on the side of the regulator body adjacent to the outlet. With the appliance operating check the outlet pressure
 - when all burners of the appliance are operating at maximum,
 - when the smallest burner of the appliance is operating at minimum.
- Under these conditions the outlet pressure should not vary from the nominal outlet pressure of 2.60kPa by more than $\pm 0.52\text{kPa}$.
8. If the regulator appears to not be performing satisfactorily then check the following points:
 - If the outlet pressure is consistently too low then the inlet pressure may be too low and adjustment of an upstream regulator may be needed, or an upstream regulator or valve with insufficient flow capacity may be present in the gas supply line.
 - If this is suspected then it may be necessary to repeat the checks whilst measuring both the inlet and outlet pressure to determine if the inlet pressure is in the range 2.75 – 7.00kPa.
 - Check that the insert has been fitted correctly.
 - Check that the turret screw is fully screwed down.
 - Check that the regulator has been fitted to the gas supply line in the correct orientation, the arrow on the base of the body indicates the direction of gas flow.

Once these checks have been completed, if the regulator still fails to perform in a satisfactory manner it should be replaced.

9. One by one, turn the knobs to minimum and screw in the bypass screw (accessible when the knob is removed) until a small stable flame results. Turn the knob to maximum and then back to minimum to ensure that the correct minimum flame is maintained.
10. Attach the LPG sticker to the cooker, near the gas supply inlet. Cover the Natural Gas label that is factory fitted.

Figure 8

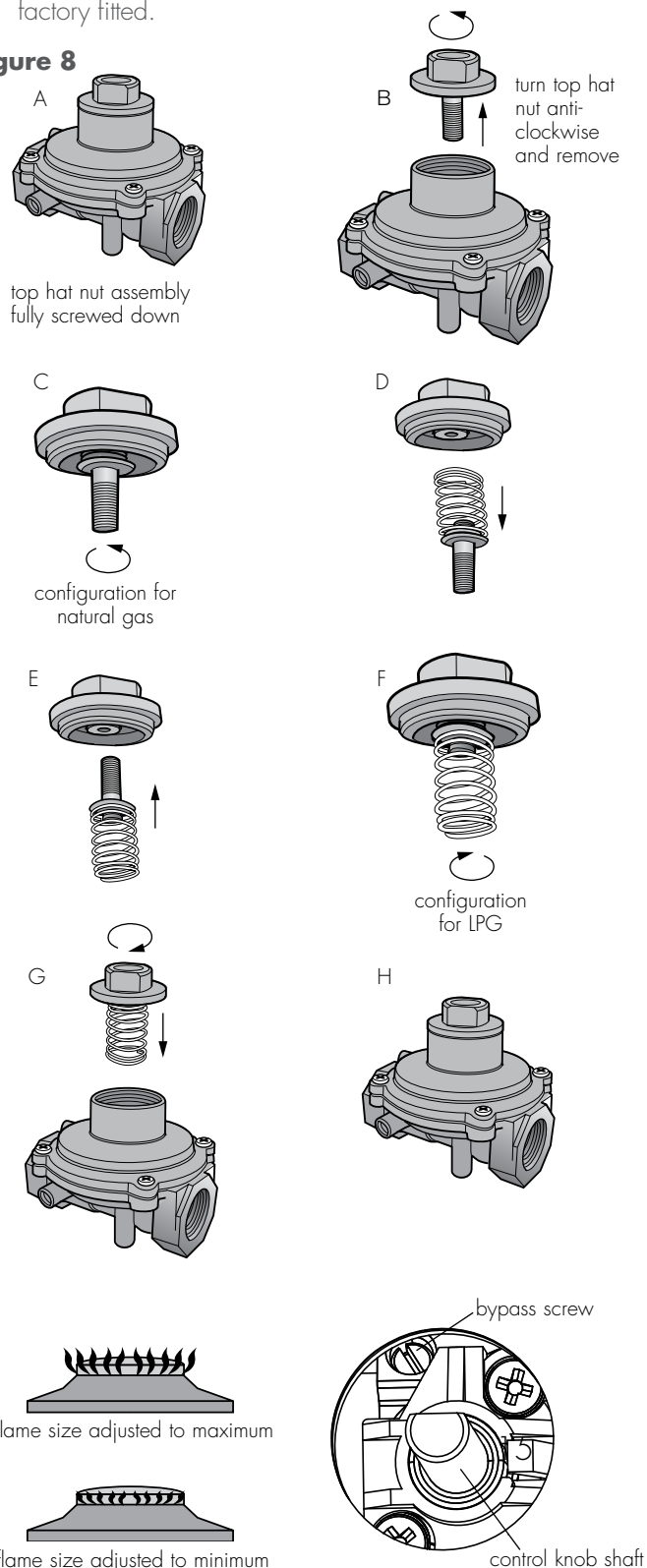

electrical connection

Battery connection

The battery used is a 1.5 Volt 'AA' Battery. This supplies the power for the ignition system of the cooktop. To install, follow the safety instructions as shown on Figure 9 below.

NOTE: Pay special attention to the orientation of the battery when installing.

The battery supplied is a perishable item and not covered by the warranty.

Electrical connection (220-240 Volts)

Where applicable, the appliance is supplied with a standard 7.5 Amp service cord terminated by a 3-pin plug for connection to a standard household socket. The electrical supply is required to power the electronic ignition system.

NOTE: It will be necessary for servicing purposes to disconnect the electrical power supply. The power point should therefore be accessible after the appliance is installed, as specified in the local wiring regulations.

Diagram 1 is a schematic of the wiring in the appliance.

The weight of the unit is printed on the appliance packaging label.

Battery holder installation instructions

1. Locate a convenient position to mount battery holder, keeping it away from hot surfaces.



WARNING

DO NOT attach it to the base of the cooktop.

2. Ensure mounting surface is clean.
3. Remove protective tape from rear of holder and stick in place.

Figure 9

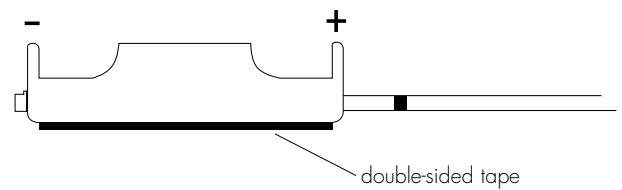

Use of hose assemblies

Ensure that the hose assembly is restrained from accidental contact with the flue outlet of an underbench oven or any other hot surface of an adjacent appliance.

Diagram 1

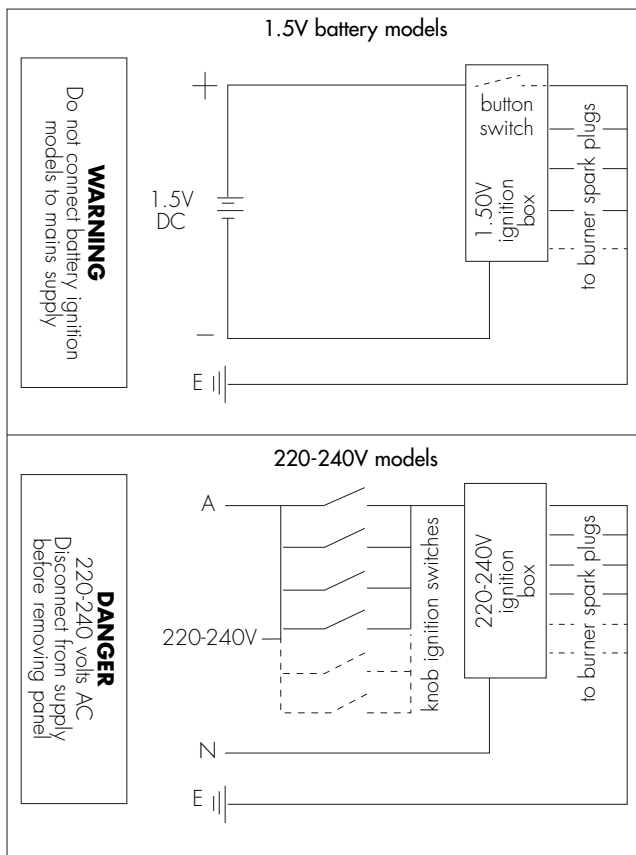

testing appliance operation

After installation, test the appliance and ensure that it operates correctly before handing it over to the customer. The following procedure is recommended:

1. Turn on the gas and electricity supply and attempt ignition on all burners, both separately and in combination. (For correct procedure, refer to page 4). Note that additional time needs to be allowed for the initial lighting as air has to be purged from the pipes.
2. Observe the flame appearance on each burner. (Figure 10) If it is much larger or much smaller than expected, the injector size and supply pressure require checking. Where a flame is unsatisfactory, refer to the Troubleshooting Guide (Page 6) to correct the fault. If the Troubleshooting Guide does not solve the problem, call the Service Centre.
3. When all the foregoing is satisfactory, check the turndown (minimum or low) setting on each burner, as this may need adjustment. Valves have a by pass controlling screw, which may be accessed by removing the knob. This screw will be located on a particular area of the valve. (Refer figure 11). Normally, this will have been correctly set at the factory for use on NG (Natural Gas) and should not require adjustment.
If the appliance has been converted to LPG, then the bypass screw will have to be screwed in until a small, stable flame results.

Please ensure the supply pressure has been checked PRIOR to any adjustment.

4. If the appliance cannot be adjusted to perform safely, inform the customer of the problem and affix an appropriate warning notice to the appliance. If the fault appears to be dangerous the appliance should be disconnected. If a minor fault exists, the customer may wish to use the appliance while awaiting service.
If a fault cannot be fixed, please call the Service Centre.
5. The customer should be advised that, in the event of a fault, the local Service Organisation or the retailer from whom the appliance was purchased should be contacted.
6. When satisfied that the unit is operating correctly, turn off and instruct the customer on correct operation as outlined in this booklet. Ask the customer to operate the controls to ensure that the correct procedure is understood.

warning

Servicing must only be carried out by an authorised service person.

Injector sizes required for various gas types are shown in Table 3 (page 14). The appliance inlet pressure for each gas type is also shown.

For model identification after installation, an additional data plate sticker has been provided. This sticker is to be stuck onto adjacent cabinetry.

Figure 10

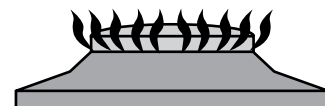

Flame size adjusted to maximum

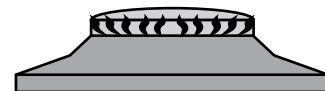

Flame size adjusted to minimum

Figure 11

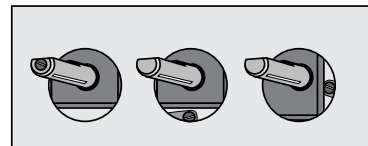

Bypass screw



FOR SALES IN AUSTRALIA AND NEW ZEALAND
 APPLIANCE: BUILT-IN OVEN, COOKTOP
 AND FREESTANDING COOKERS

This document sets out the terms and conditions of the product warranties for Electrolux Appliances. It is an important document. Please keep it with your proof of purchase documents in a safe place for future reference should you require service for your Appliance.

1. In this warranty:
 - (a) 'acceptable quality' as referred to in clause 10 of this warranty has the same meaning referred to in the ACL;
 - (b) 'ACL' means Schedule 2 to the Competition and Consumer Act 2010;
 - (c) 'Appliance' means any Electrolux product purchased by you and accompanied by this document;
 - (d) 'ASC' means Electrolux authorised service centres;
 - (e) 'Electrolux' means Electrolux Home Products Pty Ltd of 163 O'Riordan Street, Mascot NSW 2020, ABN 51 004 762 341 in respect of Appliances purchased in Australia and Electrolux (NZ) Limited (collectively 'Electrolux') of 3-5 Niall Burgess Road, Mount Wellington, in respect of Appliances purchased in New Zealand;
 - (f) 'major failure' as referred to in clause 10 of this warranty has the same meaning referred to in the ACL and includes a situation when an Appliance cannot be repaired or it is uneconomic for Electrolux, at its discretion, to repair an Appliance during the Warranty Period;
 - (g) 'Warranty Period' means the Appliance is warranted against manufacturing defects in Australia for 24 months and in New Zealand for 24 months, following the date of original purchase of the Appliance;
 - (h) 'you' means the purchaser of the Appliance not having purchased the Appliance for re-sale, and 'your' has a corresponding meaning.
2. This warranty only applies to Appliances purchased and used in Australia or New Zealand and used in normal domestic applications and is in addition to (and does not exclude, restrict, or modify in any way) any non-excludable statutory warranties in Australia or New Zealand.
3. During the Warranty Period Electrolux or its ASC will, at no extra charge if your Appliance is readily accessible for service, without special equipment and subject to these terms and conditions, repair or replace any parts which it considers to be defective. Electrolux or its ASC may use remanufactured parts to repair your Appliance. You agree that any replaced Appliances or parts become the property of Electrolux. This warranty does not apply to light globes, batteries, filters or similar perishable parts.
4. Parts and Appliances not supplied by Electrolux are not covered by this warranty.
5. To the extent permitted by law, you will bear the cost of transportation, travel and delivery of the Appliance to and from Electrolux or its ASC. If you reside outside of the service area, you will bear the cost of:
 - (a) travel of an authorised representative;
 - (b) transportation and delivery of the Appliance to and from Electrolux or its ASC.

In all instances, unless the Appliance is transported by Electrolux or an Electrolux authorised representative, the Appliance is transported at the owner's cost and risk while in transit to and from Electrolux or its ASC.
6. Proof of purchase is required before you can make a claim under this warranty.

7. You may not make a claim under this warranty unless the defect claimed is due to faulty or defective parts or workmanship. Electrolux is not liable in the following situations (which are not exhaustive):
 - (a) the Appliance is damaged by:
 - (i) accident
 - (ii) misuse or abuse, including failure to properly maintain or service
 - (iii) normal wear and tear
 - (iv) power surges, electrical storm damage or incorrect power supply
 - (v) incomplete or improper installation
 - (vi) incorrect, improper or inappropriate operation
 - (vii) insect or vermin infestation
 - (viii) failure to comply with any additional instructions supplied with the Appliance;
 - (b) the Appliance is modified without authority from Electrolux in writing;
 - (c) the Appliance's serial number or warranty seal has been removed or defaced;
 - (d) the Appliance was serviced or repaired by anyone other than Electrolux, an authorised repairer or ASC.
8. This warranty, the contract to which it relates and the relationship between you and Electrolux are governed by the law applicable where the Appliance was purchased. Where the Appliance was purchased in New Zealand for commercial purposes the Consumer Guarantee Act does not apply.
9. To the extent permitted by law and subject to your non-excludable statutory rights and warranties, Electrolux excludes all warranties and liabilities (other than as contained in this document) including liability for any loss or damage whether direct or indirect arising from your purchase, use or non use of the Appliance.
10. For Appliances and services provided by Electrolux in Australia, the Appliances come with a guarantee by Electrolux that cannot be excluded under the ACL. You are entitled to a replacement or refund for a major failure and for compensation for any other reasonably foreseeable loss or damage. You are also entitled to have the Appliance repaired or replaced if the Appliance fails to be of acceptable quality and the failure does not amount to a major failure. The benefits to you given by this warranty are in addition to your other rights and remedies under a law in relation to the Appliances or services to which the warranty relates.
11. At all times during the Warranty Period, Electrolux shall, at its discretion, determine whether repair, replacement or refund will apply if an Appliance has a valid warranty claim applicable to it.
12. For Appliances and services provided by Electrolux in New Zealand, the Appliances come with a guarantee by Electrolux pursuant to the provisions of the Consumer Guarantees Act, the Sale of Goods Act and the Fair Trading Act.
13. To enquire about claiming under this warranty, please follow these steps:
 - (a) carefully check the operating instructions, user manual and the terms of this warranty;
 - (b) have the model and serial number of the Appliance available;
 - (c) have the proof of purchase (e.g. an invoice) available;
 - (d) telephone the numbers shown below.
14. You accept that if you make a warranty claim, Electrolux and its ASC may exchange information in relation to you to enable Electrolux to meet its obligations under this warranty.

Important Notice

Before calling for service, please ensure that the steps listed in clause 13 above have been followed.

<p>FOR SERVICE or to find the address of your nearest state service centre in Australia PLEASE CALL 13 13 49 <small>For the cost of a local call (Australia only)</small></p>	<p>SERVICE AUSTRALIA ELECTROLUX HOME PRODUCTS electrolux.com.au</p>	<p>FOR SPARE PARTS or to find the address of your nearest state spare parts centre in Australia PLEASE CALL 13 13 50 <small>For the cost of a local call (Australia only)</small></p>
<p>FOR SERVICE or to find the address of your nearest authorised service centre in New Zealand FREE CALL 0800 10 66 10 <small>(New Zealand only)</small></p>	<p>SERVICE NEW ZEALAND ELECTROLUX (NZ) Limited electrolux.co.nz</p>	<p>FOR SPARE PARTS or to find the address of your nearest state spare parts centre in New Zealand FREE CALL 0800 10 66 20 <small>(New Zealand only)</small></p>

like to know more?

For further information on all appliances, or to obtain detailed dimension and installation information, call into your Retailer, phone or email our Customer Care team or visit our website:

Australia

phone: 1300 363 640
fax: 1800 350 067
email: customercare@electrolux.com.au
website chef.com.au (Chef models)
..... westinghouse.com.au (Westinghouse models)

New Zealand

phone: 0800 234 234
fax: 0800 363 600
email: customercare@electrolux.co.nz
website simpson.co.nz (Simpson models)
..... westinghouse.co.nz (Westinghouse models)

Top service

Top Service encompasses the after sales service provided by The Electrolux Group to consumers including delivery, home service and spare parts.

Chef. We are part of the Electrolux Family.
To add a touch of professional inspiration to your home,
visit electrolux.com.au

©2016 Electrolux Home Products Pty Ltd

ABN 51 004 762 341

ECN 061879 ANC 305387212 Drawing 3053872_MD

Print code: CMAN_GASCOOK_UM_Apr16

