

SUMMIT

4.4 CU. FT. HEAT PUMP DRYER

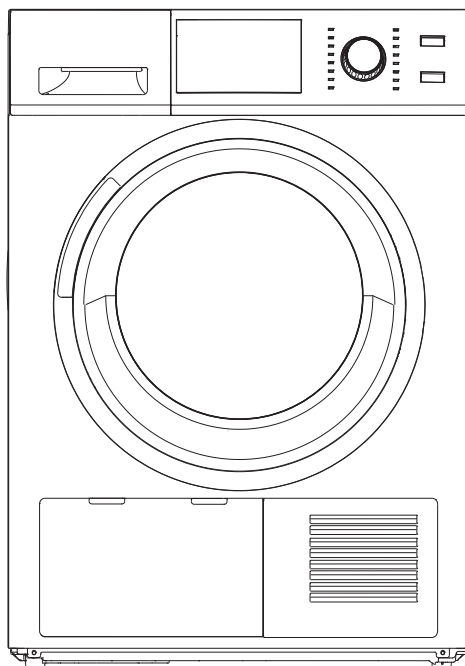

USER MANUAL MODEL LD2444

FELIX STORCH, INC.
An ISO 9001:2015 registered company
770 Garrison Avenue
Bronx, New York 10474
www.summitappliance.com

CONTENTS

SAFETY AND PRECAUTIONS	2
WHAT YOU NEED TO KNOW ABOUT SAFETY INSTRUCTIONS.....	2
IMPORTANT SAFETY SYMBOLS AND PRECAUTIONS.....	2
IMPORTANT SAFETY INSTRUCTIONS.....	2
INSTALLATION REQUIREMENTS	6
IMPORTANT TO INSTALLER.....	6
BASIC REQUIREMENTS.....	6
LOCATION REQUIREMENTS.....	6
STACK KIT INSTALLATION INSTRUCTION.....	10
DRAIN SYSTEM.....	12
ELECTRIC REQUIREMENTS.....	12
GROUNDING.....	14
REPLACEMENT PARTS AND ACCESSORIES.....	14
INSTALLATION INSTRUCTION	14
REMOVING FROM THE PACKAGE.....	15
PARTS IDENTIFICATION.....	15
TOOLS NEEDED IN INSTALLATION.....	16
INSTALLATION STEPS.....	16
OPERATING INSTRUCTION	20
CONTROL PANEL.....	20
DRYING A LOAD OF LAUNDRY.....	22
FILTER CLEAN.....	25
SPECIAL LAUNDRY TIPS.....	27
MAINTENANCE	28
CARE AND MAINTENANCE.....	28
TROUBLESHOOTING INSTRUCTIONS	29
CHECK THESE SOLUTIONS IF YOUR DRYER.....	29
ERROR CODES.....	31
APPENDIX.....	32

SAFETY AND PRECAUTIONS

Introduction

Congratulations on the purchase of your new Insignia dryer. Insignia dryers feature the latest in design and capabilities and will provide reliable and trouble-free performance.



SAFETY AND PRECAUTIONS

- WHAT YOU NEED TO KNOW ABOUT SAFETY INSTRUCTIONS

This manual contains important information on the installation, use, and care of your appliance. Please read this manual carefully before installation and operation of this machine to prevent injury and property damage.

Warnings and Important Safety Instructions in this manual DO NOT cover all possible conditions and situations that may occur. It is your responsibility to use.

- IMPORTANT SAFETY SYMBOLS AND PRECAUTIONS

	WARNING	This indicates that hazards or unsafe practices may cause serious personal injury or death . To reduce the risk of fire, explosion, electric shock, or personal injury when using your dryer, these basic safety precautions SHOULD be followed.
	CAUTION	This indicates that hazards or unsafe practices may cause minor personal injury or property damage .

 **WARNING** For your safety the information in this manual must be followed to minimize the risk of fire or explosion, or to prevent property damage, personal injury or death.

- **Do not store or use gasoline or other flammable vapors and liquids in the vicinity of this or any other appliance.**
- **Installation and service must be performed by a qualified installer, service agency, or the gas supplier.**

- IMPORTANT SAFETY INSTRUCTIONS

WARNING-To reduce the risk of fire, electric shock, or injury to persons when using your appliance, follow basic precautions, including the following:

1. Read all instructions before using the appliance.
2. Use this appliance only for its intended purpose as described in this Owner's Manual.
3. Before use, the dryer must be properly installed as described in this manual.

SAFETY AND PRECAUTIONS

4. ALWAYS follow the fabric care instructions supplied by the garment manufacturer.
5. Do not dry articles that have been previously cleaned in, washed in, soaked in, or spotted with gasoline, dry-cleaning solvents, other flammable or explosive substances as they give off vapors that could ignite or explode.
6. Do not use the dryer to dry clothes which have traces of any flammable substance, such as vegetable oil, cooking oil, machine oil, flammable chemicals, thinner, etc., or anything containing wax or chemicals, such as mops and cleaning clothes. Flammable substances may cause the fabric to catch fire by itself.
7. Do not store or use gasoline or other flammable vapors and liquids near this or any other appliance.
8. Do not allow children to play on or in the appliance. Close supervision of children is necessary when the appliance is used near children.
9. Before the appliance is removed from service or discarded, remove the lid of the washing or door of the drying compartment.
10. Do not reach into the appliance if the drum is moving.
11. Do not install or store this appliance where it will be exposed to the weather or freezing temperatures.
12. Do not tamper with the controls.
13. Do not repair or replace any part of the appliance or attempt any servicing unless it is specifically recommended in the user-maintenance instructions or in published user-repair instructions that you understand and have the skills to carry out.
14. Keep the area underneath and around your appliances free of combustible materials (lint, paper, rags, etc.), gasoline, chemicals and other flammable vapors and liquids.
15. Do not place items exposed to cooking oils in your dryer. Items contaminated with cooking oils may contribute to a chemical reaction that could cause a load to catch fire. To reduce the risk of fire due to contaminated loads, the final part of a tumble dryer cycle occurs without heat (cool down period). Avoid stopping a tumble dryer before the end of the drying cycle unless all items are quickly removed and spread out so that the heat is dissipated.
16. Turn off the water faucets and unplug the washer if the machine is to be left for an extended period of time, such as during vacations.
17. Packaging material can be dangerous for children. There is a risk of suffocation! Keep all packaging from children.
18. Always check the inside of the dryer for foreign objects before loading laundry. Keep the door closed when not in use.
19. Do not use fabric softeners or products to eliminate static unless recommended by the manufacturer of the fabric softener or product.
20. Clean the lint screen before or after each load.

SAFETY AND PRECAUTIONS

21. Keep the area around the exhaust opening and surrounding areas free from lint, dust, and dirt.
22. The interior of the dryer and exhaust duct should be cleaned periodically by qualified service personnel.
23. Do not place items exposed to cooking oils in your dryer. Items contaminated with cooking oils may contribute to a chemical reaction that could cause a load to catch fire.
24. This appliance must be grounded. See "**Electric requirements**" and "**Grounding**" in the "**INSTALLATION REQUIREMENTS**" section.
25. This appliance must be properly grounded. Never plug the power cord into a receptacle that is not grounded adequately and in accordance with local and national codes. Refer to installation instructions for grounding this appliance.
26. Ensure pockets are free from small irregularly shaped hard objects and foreign material, i.e. coins, knives, pins, etc. These objects could damage your dryer.
27. Do not use heat to dry articles containing foam rubber or similarly textured rubber-like materials.

SAVE THESE INSTRUCTIONS.



WARNING-To reduce the risk of fire or explosion

- Do not dry items that have been previously cleaned, washed, soaked, or spotted with gasoline, dry cleaning solvents, or other flammable or explosive substances. They emit vapors that could ignite or explode. Any material that has been in contact with a cleaning solvent or flammable liquids or solids should not be placed in the dryer until all traces of these flammable liquids or solids and their fumes have been removed.
- There are many highly flammable items used in homes, such as acetone, denatured alcohol, gasoline, kerosene, some liquid household cleaners, some spot removers, turpentine, waxes, and wax removers.
- Do not dry items containing foam rubber (may be labeled latex foam) or similarly textured rubber-like materials on a heat setting. Heated foam rubber materials can under certain circumstances, produce fire by spontaneous combustion.

SAFETY AND PRECAUTIONS



CAUTION

1. Do not sit on top of the dryer.
2. Because of continuing product improvements, we reserves the right of change specifications without notice. For complete details, see the Installation Instructions packed with your product before selecting cabinetry, making cutouts, or beginning installation.
3. Do not dry clothing with large buckles, buttons, or other heavy metal or solid things.
4. Install and use in accordance with the manufacturer's instructions.
5. Do not place items in your dryer that have been spotted or soaked with vegetable oil or cooking oil. Even after being washed, these items may contain significant amounts of these oils.
6. Residual oil on clothing can ignite spontaneously. The potential for spontaneous combustion increases when items containing vegetable oil or cooking oil are exposed to heat. Heat source such as your dryer can warm these items, allowing an oxidation reaction in the oil to occur.
7. Oxidation creates heat. If this heat cannot escape, the items can become hot enough to catch fire. Piling, stacking, or storing these kinds of items may prevent heat from escaping and can create a fire hazard.
8. Take care that children's fingers are not caught in door when closing it. This may result in injury.



WARNIG- Risk of Fire

- Clothes dryer installation must be performed by a qualified installer.
- Install the clothes dryer according to the manufacturer's instructions and local codes.
- To reduce the risk of severe injury or death, follow all installation instructions.
- Save these instructions.

INSTALLATION REQUIREMENTS

INSTALLATION REQUIREMENTS

■ IMPORTANT TO INSTALLER

Please read the following instructions carefully before installing the dryer. These instructions should be kept for future reference.



- The dryer is not suitable for installation in a mobile home.
- Remove the door from all discarded appliances to avoid the danger of a child being trapped and suffocating, after unplugging cut off Power Cord.

■ BASIC REQUIREMENTS

Make sure you have everything necessary for the proper installation.

- A GROUNDED ELECTRICAL OUTLET is required. Refer to the “**Electrical requirements**” section.
- A POWER CORD electric dryer (except for Canada).

■ LOCATION REQUIREMENTS

1. The dryer should be located where there is enough space at the front for loading the dryer, and enough space behind for the exhaust system.
2. Make sure the room in which the dryer is located has enough fresh air. The dryer must be located where there are no air-flow obstructions.
3. The dryer must not be installed or stored in an area where it will be exposed to water and/or weather. The dryer area must be kept clear of combustible materials, gasoline, and other flammable vapors and liquids. A dryer produces combustible lint. The area around the dryer should be kept lint-free.

INSTALLATION REQUIREMENTS

Alcove or closet or wall insert/recessed installations



- No other fuel-burning appliance should be installed in the same closet as the dryer.

Minimum clearances between the dryer and adjacent walls or other surfaces :

Sides	1 in. (25.4mm)	Rear	2 in.(50.8mm)
Top	2 in. (50.8mm)	Closet front	2 in. (50.8mm)

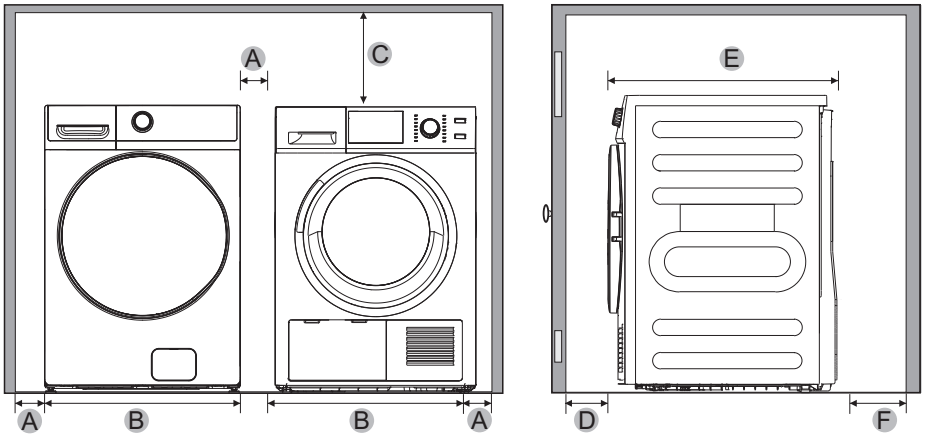

A	1 in. (25.4mm)	C	2 in. (50.8mm)	E	25.7 in. (653mm)
B	23.4 in. (595mm)	D	2 in. (51mm)	F	2 in. (50.8mm)

INSTALLATION REQUIREMENTS

Undercounter installation

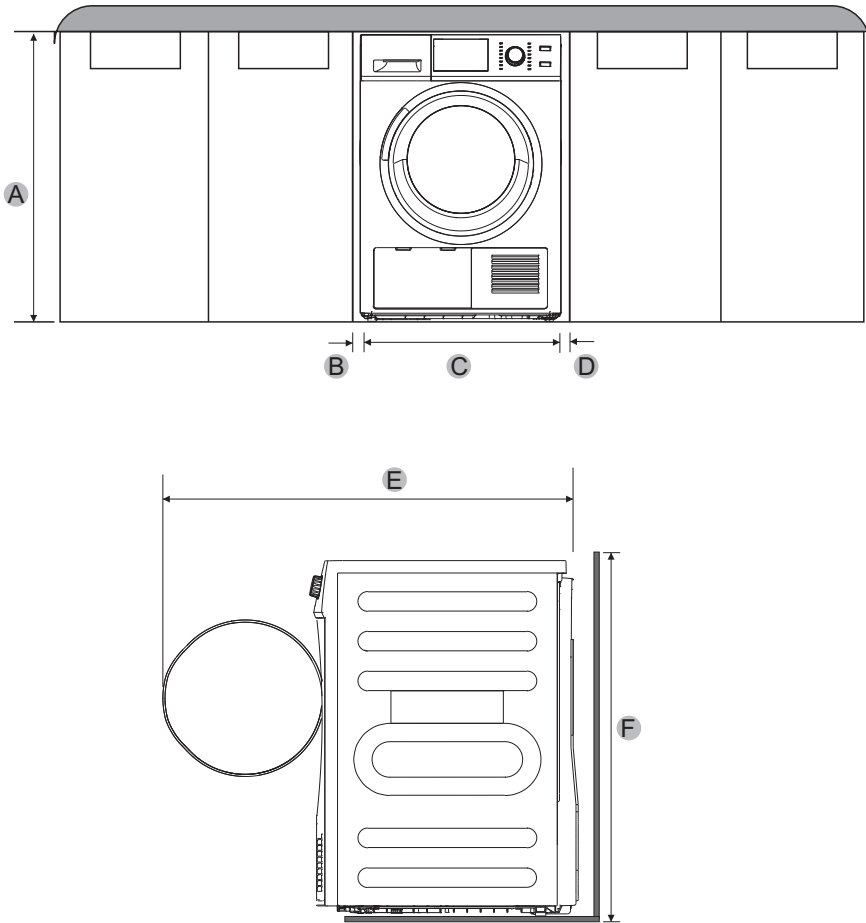

A	≥35.5in.(≥901mm)	C	23.4 in. (595mm)	E	42.2in.(1072mm)
B	1 in. (25mm)	D	1 in. (25mm)	F	33.5in.(850mm)

INSTALLATION REQUIREMENTS

Installation with stacked washing machine and dryer

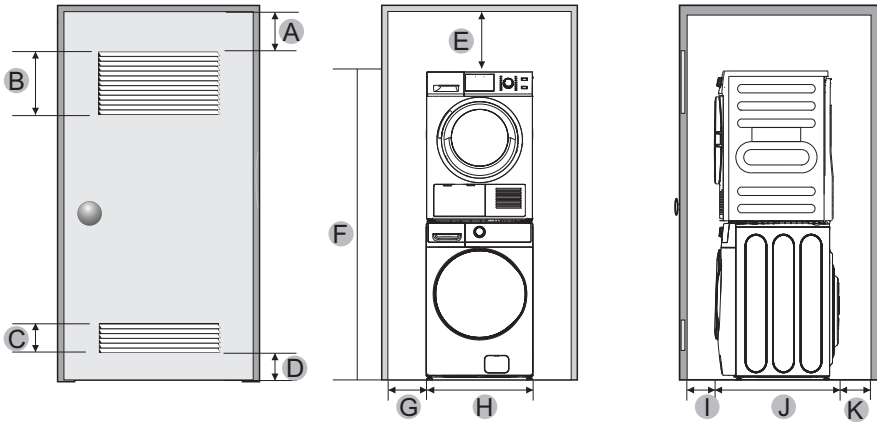

A	3in.(76mm)	E	2in.(50.8mm)	I	3in.(76mm)
B	48in. ² (3100mm ²)	F	/	J	25.7 in.(653mm)
C	24in. ² (1550mm ²)	G	1in.(25.4mm)	K	2 in.(50.8mm)
D	3in.(76mm)	H	23.4 in. (595mm)		

NOTE

The front of the closet must have two unobstructed air openings for a combined minimum total area of 72 sq.in. (465 sq.cm) with a minimum clearance of 3 in. (76mm) at the top and bottom. A slatted door with equivalent space clearance is acceptable.

INSTALLATION REQUIREMENTS

Stack Kit Installation Instruction

1. The stacking kit includes the following parts:

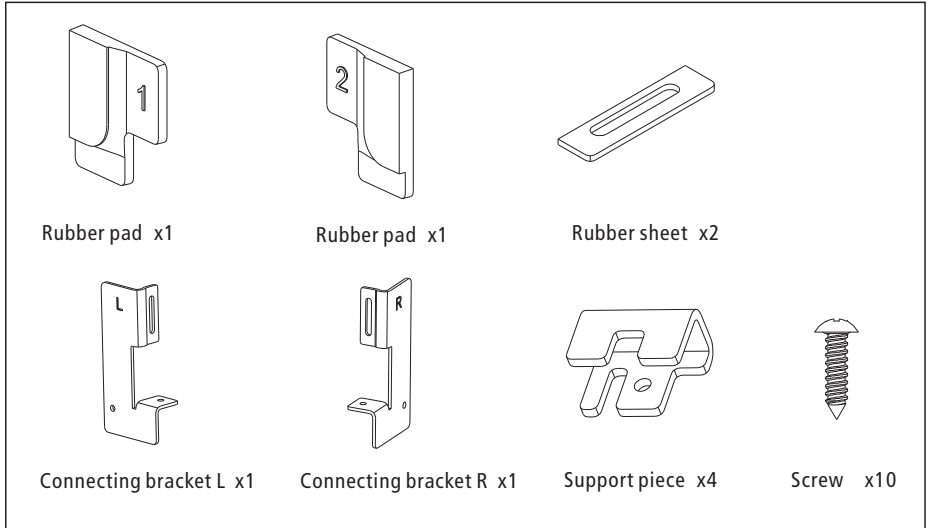

2. Rubber pad attaching position

Attach the rubber pad to the top cover of the front loader, as shown in the figure below:

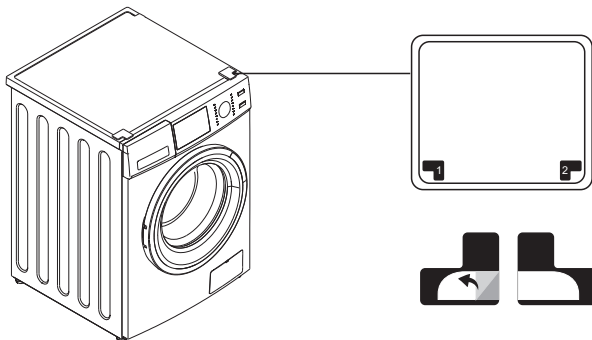

INSTALLATION REQUIREMENTS

3. Support piece installation

Install the support at the bottom of the dryer, as shown in the figure below:

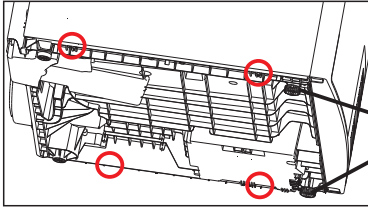

Screw the two feet on the front of the dryer to the minimum distance (clockwise rotation)

4. Method for stacking clothes dryer and washing machine

Lift the dryer to the top of the washing machine. Adjust the position of the dryer to align both sides, as shown in the picture:

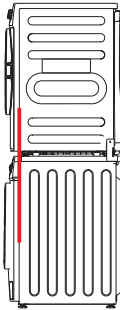

5. Connecting bracket installation

1. Remove the screws at the back of the dryer, first fix the connecting bracket and the rubber sheet to the back of the dryer and align the U-shaped holes of the rubber sheet and the connecting bracket.
2. Use a 3mm diameter drill bit to drill the remaining two screw holes. Then use a torque not exceeding 5Nm to fix the screws.

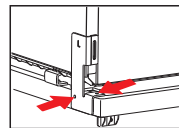
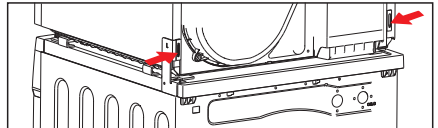
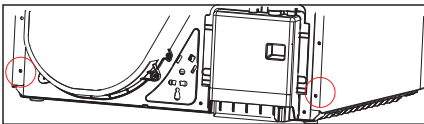

INSTALLATION REQUIREMENTS

■ DRAIN SYSTEM

The following parts are optional for specific models.

If your dryer has following parts, please wear gloves and install them as per the instruction below.

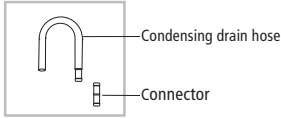

Installation

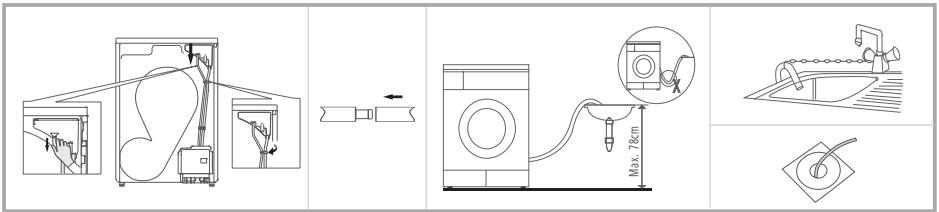

1. Take the hose out of the holder.
2. Disconnect the hose from the water container inflow. (To assure water tightness, there is tension between the hose and the inflow and therefore an increased force is required for disassembly.)
3. Insert the drain hose and the external drainage hose into the connector.
4. Put the hose on the washing basin or floor drain. To assure the smooth drainage, ensure the pipe is not folded.

■ ELECTRIC REQUIREMENTS

The wiring diagram is located on the back board of the unit.



- The improper connection of the equipment grounding conductor can result in the risk of electric shock. Check with a qualified electrician or serviceman if you are in doubt as to whether your dryer is properly grounded. Do not modify the plug provided with your dryer - if it doesn't fit the outlet, have a proper outlet installed by a qualified electrician.
- To prevent unnecessary risk of fire, electrical shock, or personal injury, all wiring and grounding must be done in accordance with local codes, or in the absence of local codes, with the National Electrical Code, ANSI/NFPA No. 70 - Latest Revision (for the U.S.) or the Canadian Electrical Code CSA C22.1 - Latest Revisions and local codes and ordinances. It is your responsibility to provide adequate electrical services for your dryer.
- All gas installations must be done in accordance with the National Fuel Code ANSI/Z2231 - Latest Revision (for the U.S.) or CAN/CGA - B149 Installation Codes - Latest Revision (for Canada) and local codes and ordinances.

INSTALLATION REQUIREMENTS

Electrical connections

An individual branch (or separate) circuit serving only your dryer is recommended.
DO NOT USE AN EXTENSION CORD.

Electric models - U.S. only

The dryers require a 120/240 volt, 60Hz AC approved electrical service.
The electric service requirements can be found on the data label located on the back.

A 30-ampere fuse or circuit breaker on both sides of the line is required.

- If a power cord is used, the cord should be plugged into a 30-ampere receptacle.
- The power cord is NOT provided with U.S. electric model dryers.



RISK OF ELECTRIC SHOCK:

When local codes allow, the electrical supply of the dryer may be connected by means of a new power supply cord kit, marked for use with a dryer, that is UL listed and rated at a minimum of 120/240 volts, 30-ampere with three No. 10 copper wire conductors terminated with closed loop terminals, open-end spade lugs with turned up ends, or with tinned leads.

- Do not reuse a power supply cord from an old dryer. The power cord electric supply wiring must be retained at the dryer cabinet with a suitable UL-listed strain relief.
- Grounding through the neutral conductor is prohibited for (1) new branch-circuit installations, (2) mobile homes, (3) recreational vehicles, and (4) areas where local codes prohibit grounding through the neutral conductor. (Use a 4-prong plug for 4 wire receptacles, NEMA type 14-30R.)

Electric models - Canada only

- A 120/240 volt, 60Hz AC approved electrical service fused through a 30-ampere fuse or circuit breaker on both sides of the line is required.
- All Canadian models are shipped with the power cord attached. The power cord should be plugged into a 30-ampere receptacle.

Note: A power cord is NOT provided with U.S. electric model dryers

INSTALLATION INSTRUCTION

- **Install the clothes dry according to manufacture's instructions and local codes.**
- **GROUNDING**
 - For products sold in the U.S., your dryer has an optional cord with an equipment-grounding conductor and a grounding plug, which is sold separately. For products sold in Canada, your dryer is equipped with a cord having an equipment-grounding conductor and a grounding plug.
 - The plug must be plugged into an appropriate outlet that is properly installed and grounded in accordance with all local codes and ordinances.
 - Do not modify the plug provided with the appliance: if it will not fit the outlet, have a proper outlet installed by a qualified electrician.
 - If a power cord is not used and the electric dryer is to be permanently wired, This appliance must be connected to a grounded metal, permanent wiring system, or an equipment-grounding conductor must be run with the circuit conductors and connected to the equipment-grounding terminal or lead on the appliance.



WARNING

- Improper connection of the equipment-grounding conductor can result in a risk of electric shock. Check with a qualified electrician or service representative or personnel, if you are in doubt as to whether the appliance is properly grounded.
- Certain internal parts are intentionally not grounded and may present a risk of electric shock only during servicing. service personnel-do not contact the following parts while the appliance is energized: Main Motor; Cooling Fan.

INSTALLATION INSTRUCTION

INSTALLATION INSTRUCTION

■ REMOVING FROM THE PACKAGE

1. Unpack your dryer and inspect it for shipping damage. Make sure you have received all the items shown below.
2. To prevent personal injury or strain, wear protective gloves whenever lifting or carrying the unit.



Packaging materials can be dangerous to children;
Keep all packaging material (plastic bags, polystyrene, etc.) well out of children's reach.

■ PARTS IDENTIFICATION

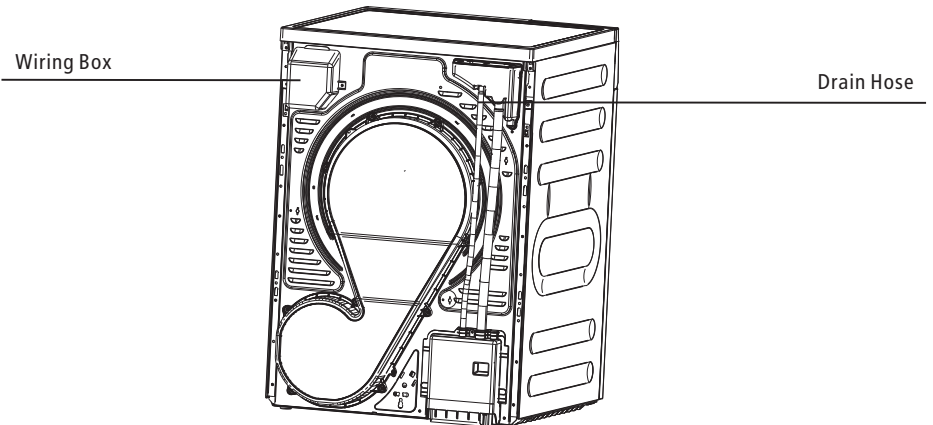
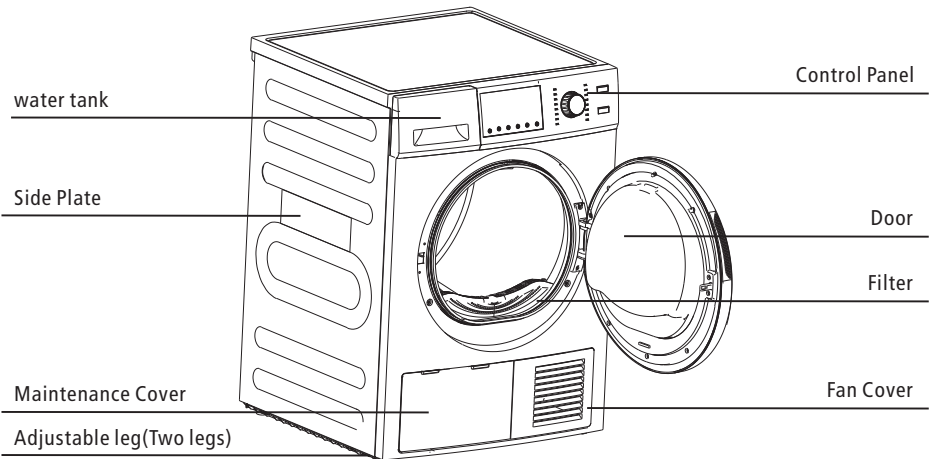

INSTALLATION INSTRUCTION

■ TOOLS NEEDED IN INSTALLATION

Tools needed:

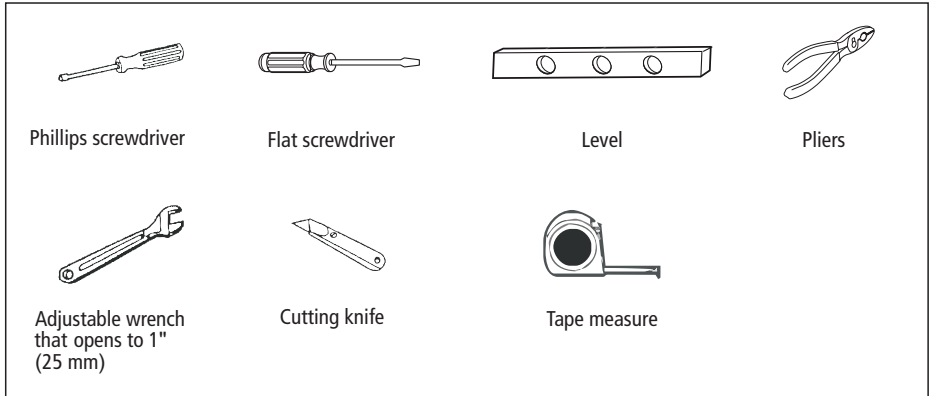

■ INSTALLATION STEPS

For the proper installation, we recommend that you hire a qualified installer.

STEP 1 Choose the proper location

1. Move your dryer to an appropriate location for the installation. Consider installing the dryer and washer side-by-side, to allow access to the gas, electrical, and exhaust connections. Place two of the carton cushion-tops on the floor. Tip your dryer on its side so it lies across both cushion-tops.
2. Set your dryer back in an upright position.

STEP 2 Connect the electrical wiring

Three wire outlet

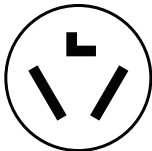

3-Wire
receptacle
(10-30R)

Then choose a 3-wire power supply cord with ring terminals and UL listed strain relief. The 3-wire power supply cord, at least 4.92 ft. (1.5 m) long, must have 3 10-gauge solid copper wires and match a 3-wire receptacle of NEMA Type 10-30R, rated 120/240V, min 10A.

INSTALLATION INSTRUCTION

3-Wire system connections

1. Connect the grounding wire of the power cord to the external ground conductor screw. If there is no grounding wire of the power cord, please remove the Neutral grounding wire from center terminal block screw of the dryer, then connect it to the external ground conductor screw and connect the neutral wire to the center terminal block screw.
2. Remove the two side terminal block screw and connect the other wires to the outer terminal screws. Be sure to cross the screw through the terminal ring and tighten the screw.
3. Tighten the strain relief screws.
4. Insert the tab of the terminal block cover into your dryer's rear panel slot. Secure the cover with a screw.

3-Wire system instructions:

- A Center terminal block screw
- B External ground connector
- C Neutral grounding wire (White)
- D Neutral wire (white or center wire)
- E 3/4" (1.9cm) UL-listed strain relief

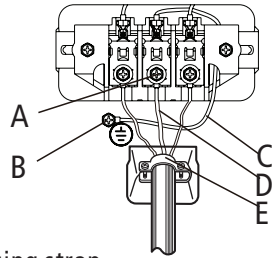

- Ring-type terminals are recommended. If using strap terminals, make sure they are tightened.

Four wire outlet

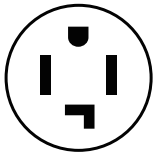

4-Wire
receptacle
(14-30R)

Then choose a 4-wire power supply cord with ring terminals and UL listed strain relief. The 4-wire power supply cord, at least 4.92 ft. (1.5 m) long, must have 4 10-gauge solid copper wires and match a 4-wire receptacle of NEMA Type 14-30 R, rated 120/240V, min 10A. The ground wire (ground conductor) may be either green or bare. The neutral conductor must be identified by a white color.

4-Wire system connections

1. Remove the center terminal block screw.
2. Connect the ground wire (green or unwrapped) of the power cord to the external ground conductor screw.
3. Connect the neutral wire (white or center wire) of the power cord and the appliance ground wire (white) under the center screw of the terminal block. Be sure to cross the screw through the ring of the power cord terminal and tighten the screw.
4. Connect the other wires to the outer terminal block screws. Be sure to cross the screw through the terminal ring and tighten the screw.

INSTALLATION INSTRUCTION

5. Tighten the strain relief screws.
6. Insert the tab of the terminal block cover into your dryer's rear panel slot. Secure the cover with a screw.

4-Wire system instructions:

IMPORTANT: Ring-type terminals are recommended. If using strap terminals, make sure they are tightened.

- A Center terminal block screw
- B External ground connector
- C Green or bare copper wire of the power cord
- D Neutral grounding wire (White)
- E Neutral wire (white or center wire)
- F 3/4" (1.9cm) UL-listed strain relief

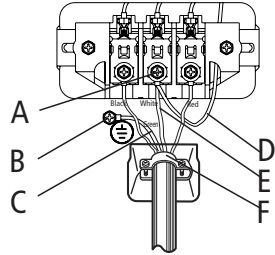

WARNING

Ring-type terminals are recommended. If using strap terminals, make sure they are tightened.



WARNING

U.S. Models:

Risk Of Electric Shock - All U.S. models are produced for a **3-WIRE SYSTEM CONNECTION**.

The dryer frame is grounded to the neutral conductor at the terminal block.

A **4-WIRE SYSTEM CONNECTION** is required for new or remodeled construction, mobile homes, or if local codes do not permit grounding through neutral conductor.

If the 4-wire system is used, the dryer frame cannot be grounded to the neutral conductor at the terminal block. Refer to the "**Electric requirements**" section on page 14 for 3-WIRE or 4-WIRE SYSTEM CONNECTIONS.

Remove the terminal block plate.

Insert the power cord with a UL-listed strain relief through the hose provided in the cabinet near the terminal block.

- A strain relief must be used.

Do not loosen the nuts already installed on the terminal block. Be sure they are tight.

Use a 3/8" (1 cm) deep well socket.

STEP 3 Level the dryer

To ensure that the dryer provides the optimal drying performance, it must be leveled. To minimize vibration, noise, and unwanted movement, the floor must be a perfectly level, solid surface.

- Adjust the leveling feet only as much as necessary to level the dryer. Extending the leveling feet more than necessary can cause the dryer to vibrate.

INSTALLATION INSTRUCTION

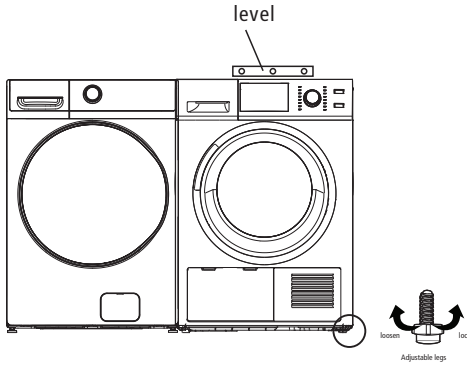

STEP 4 Power on

Make sure all electrical connections are complete. Plug in your dryer.

STEP 5 Final check

- Make sure the dryer is plugged into an electrical outlet and is properly grounded.
- The dryer is leveled and is sitting firmly on the floor.
- Start your dryer to confirm that it runs, heats, and shuts off.

OPERATING INSTRUCTION

OPERATING INSTRUCTION

■ CONTROL PANEL



WARNING

To reduce the risk of fire, electric shock, or injury to persons, read the IMPORTANT SAFETY INSTRUCTIONS before operating the appliance.

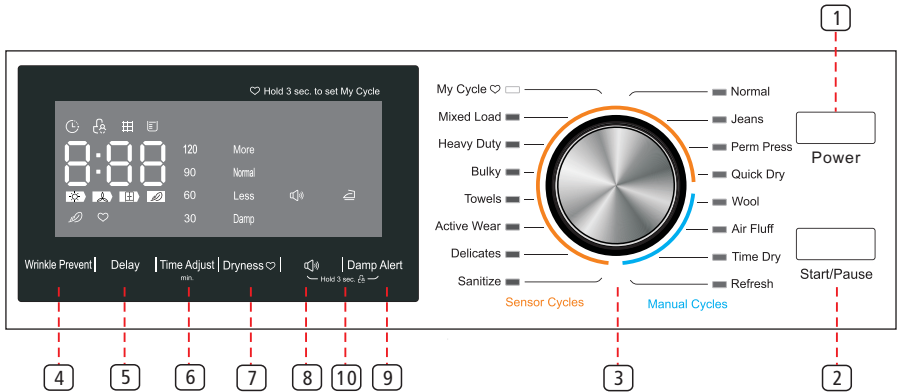

1-Power button

Press to turn your dryer on or into stand-by situation. If your dryer is on for more than 10 minutes without any buttons being pressed, it automatically turns into stand-by situation.

2-Start/Pause button

Press to start or pause the program. You can't change any setting except add a garment.

3-Cycle selector

Select your desired cycle for the type of load.

The cycle you select determines the heat control for the cycle.

The Normal, Jeans, Perm Press, Quick Dry, My Cycle, Mixed Load, Heavy Duty, Bulky, Towels, Active Ware, Delicates, Sanitize are Sensor cycles.

Wool, Air Fluff, Time Dry, Refresh are Manual cycles.

4-Wrinkle Prevent

Press once to add the wrinkle care step into the operating program. Press again to cancel selection.

If wrinkle prevent was active, it provides approximately 90 minutes of intermittent tumbling in unheated air at the end of the cycle to reduce wrinkling.

The load is already dry, and can be removed at any time during the wrinkle care cycle.

OPERATING INSTRUCTION

5-Delay

This function is used for delaying clothes drying time within 24 hours. The delay time means the programme will start after x hours. When the delay programme starts, the time starts to countdown on the display and the delay icon blinks.

6-Time Adjust

These buttons are effective only for Manual cycles. Press these buttons to change the drying time you prefer. Push repeatedly to get your desired drying time, including 120minutes,90minutes, 60minutes, 30minutes.

7-Dryness

Press the button to select the dry level, including More, Normal, Less, Damp. Different dry level will result in different drying time. For clothes to be ironed manually, a lower dry level should be selected.

Press and hold for 3 seconds to remember your favorite drying cycle, this cycle will be "My Cycle".

8-signal

Press once to stop the buzzer sound. Press again to activate the sound. Your selection will be kept until next pressing.

9-Damp Alert

This function is useful when you want to take some garments out for ironing. The unit will beep 10s when the moisture in the clothes is good for ironing. At this time, you can take those garments out and continue drying the other by pressing the "START/PAUSE" button once.

Note: The unit will not stop operating if you don't take those garments out for ironing.

10-Control Lock

Press the "Mute" and "Damp Alert" together to activate the control lock function. Press again for another 3 seconds to deactivate the function. All buttons except the "Power" will be out of function when control lock activated.

Symbols



Delay start



Wrinkle Prevent



Control lock



My Cycle



Clean filter



Buzzer sound open



Water tank full
(you should empty
water tank)



Damp alert open

Cycle phase status



Means machine was drying
with heating air



Means machine was working
with cooling air



Means it is time to open the door



Means machine was making
wrinkle care

OPERATING INSTRUCTION

■ DRYING A LOAD OF LAUNDRY

STEP 1: Power on your dryer

- Press this Power button to power your dryer on.

STEP 2: Load your dryer

- Place only one wash load in your dryer at a time.
- Mixed loads of heavy and light weight fabrics will dry differently, which may result in lightweight fabrics being dry while heavy fabrics remain damp at the end of a drying cycle.
- Add one or more similar items to your dryer when only one or two articles of clothing need drying. This improves the tumbling action and drying efficiency.
- Overloading restricts tumbling action, resulting in uneven drying as well as excessive wrinkling of some fabrics.

STEP 3: Select the appropriate cycle and options for the load

- Select the appropriate cycle by Cycle Selector according to the cycle chart on page 18-19.
- Select the appropriate optional function by buttons according to the chart on page 19.

-My cycle

Once you have set the cycle selector and option function, you can push and hold the "Dryness" button for 3 seconds to memory this setting as your favorite cycle before start the unit.

The light beside the knob will flash to confirm the memory with beeps.

- You can finish this Step by just select the "My cycle" once to use your favorite.

STEP 4: Start your dryer

Pressing Start/Pause button will start the selected cycle. To PAUSE cycle press Start/Pause button then open the door. To resume operation after closing the door always presses Start/Pause.

Opening the door during the operation will instantly stop operation and will require pressing Start/Pause button to resume operation.

OPERATING INSTRUCTION

Cycle	Maximum Amount	Dryness Level	Delay	Time Adjust	Damp Alert	Wrinkle Prevent
Normal		Damp Less Normal More	Y	N	Y	Y
Jeans		Damp Less Normal More	Y	N	Y	Y
Perm Press		Damp Less Normal More	Y	N	Y	Y
Quick Dry		Damp Less Normal More	Y	N	Y	Y
Wool		/	Y	N	N	Y
Air Fluff		/	Y	Y	N	Y
Time Dry	/	/	Y	Y	N	Y
Refresh		/	Y	Y	N	Y
Sanitize		More	Y	N	N	Y
Delicates		Damp Less Normal More	Y	N	Y	Y
Active Ware		Damp Less Normal More	Y	N	Y	Y
Towel		Damp Less Normal More	Y	N	Y	Y
Bulky		Damp Less Normal More	Y	N	Y	Y
Heavy Duty		Damp Less Normal More	Y	N	Y	Y
Mixed Load		Damp Less Normal More	Y	N	Y	Y
My Cycle	/	/	/	/	/	/

* Table in **bold** is an initial setting. "Y" are all optional functions you can select.

* For even better drying effect, please select higher dry level.

Load Size Recommendations:

For best results, follow the wet load size recommendations noted for each cycle.



Small load: Fill the dryer drum with 3-4 items, not more than 1/4 full.



Medium load: Fill the dryer drum up to about 1/2 full.



Large load: Fill the dryer drum up to about 3/4 full. Do not overload. Items need to tumble freely.

OPERATING INSTRUCTION

For best results, follow the wet load size recommendations noted for each cycle.
For the best performance, the load for each cycle should be recommended as follows:

Cycle	Items Weight	Recommend load
Normal	81b	Cotton
Jeans	81b	Jeans
Perm Press	7.5b	Chemical fiber(easy care)
Quick Dry	21b	small accounts of clothing
Wool	31b	Wool
Air Fluff	21b	/
Time Dry	81b	/
Refresh	31b	/
Sanitize	51b	Cotton
Delicates	31b	Delicates
Active Ware	51b	sports clothes, Chemical fiber
Towel	81b	Towels
Bulky	41b	bedsheet
Heavy Duty	81b	Jeans, sports clothes, skirts
Mixed Load	81b	Chemical fiber

STEP 5: Unloading your laundry

- The "Clean filter" will flash 10 sec. when your laundry load is powered on.
- The dryer will beep 3 times after the cycles done.
- You should clean the filter after every load once the laundry is unloaded.

Note:

1. Clothes that are easy to be tangled or worn and small pieces, please put them in the laundry bag to dry.
2. Clothes with long belts or ropes, please make a knot to dry.
3. Clothes with slender buttons, please button up to dry.
4. Clothes with zippers, please zip up and flip to the inside to dry.

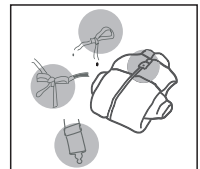

OPERATING INSTRUCTION

Control Lock

This function is useful to prevent children from playing with the unit.

- Press and hold the "🔊" and "Damp Alert" buttons simultaneously for 3 seconds to activate this function. The blue "Control Lock" light will turn ON.
- Press and hold the "🔊" and "Damp Alert" buttons simultaneously again for 3 seconds to deactivate this function. The "Control Lock" light will turn OFF.
- When this function is activated, all functions will be out of function except the POWER button and DEACTIVATE function above.
- You can Power ON your unit and set this function then Power OFF. When you do so, even if the unit is powered on, you still cannot start it before the Control Lock function is deactivated.
- This function will be cancelled automatically if your unit is out of power, such as unplug the unit, power supply out of service, etc.

■ Empty the water tank

1. Pull out and hold the water tank with two hands.
2. Transfer the water tank flatly in case of water overflow.
3. Tilt the water tank, pour out the condensate water into the basin.
4. Install the water tank.

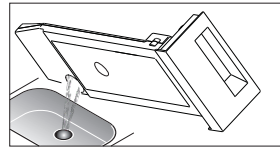
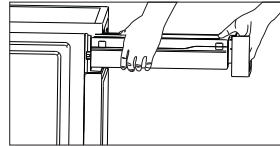

⚠ Warning!

- Empty the water tank after each use. Otherwise, the programme will be paused and the "🚰" icon will light. After the tank is emptied, the dryer can be restarted by pressing **【Start/Pause】** button.
- Do not drink the condensate water.
- Do not use the dryer without the water tank.

■ Filter clean

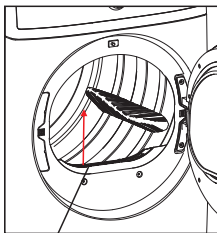

Lint filter

To prevent a risk of fire, make sure to clean the lint filter before or after every load.

- To shorten drying time.
- To operate more energy efficiently.



- Do not operate your dryer without the lint filter in place.
- Do not use a damage or broken lint filter. This may reduce performance and/or cause fire.

OPERATING INSTRUCTION

■ Clean the base filter

1. Open the cover.
2. Unlock three locking levers and grasp the filter handle.
3. Remove the base filter and clean it.
If there is too much lint on the filter, clean it in water. Dry the filter thoroughly before installing it back.
4. Clean the rubber sealing, both at the filter and handle.
5. Re-insert the filter.
6. Lock three locking levers and make sure that the levers are in correct lock position.
7. Close the cover until there is a click sound.

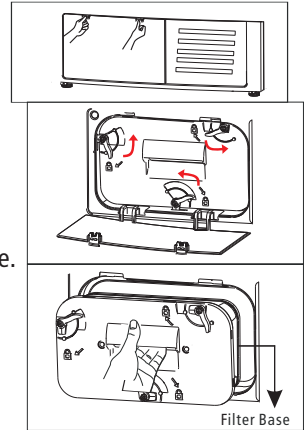

Note!

- The fluff accumulated on the filter will block the air circulation. Not cleaning the filter regularly will increase drying time and energy consumption.
- Disconnect the power cord before cleaning!
- Do not operate the dryer without the filter!
- Clean the base filter after each fifth cycle to prevent fluff accumulation inside the dryer.

■ Clean the heat exchanger

Warning!

Do not touch the heat exchanger with your hand, which may cause an injury.

- As necessary, approx. once every 2 months, remove the fluff from the heat exchanger using a vacuum cleaner with a dusting brush attached.
- Clean the heat exchanger without applying any pressure. Otherwise the heat exchanger could be damaged. The dryer will not dry if the cooling fins are damaged or bent.

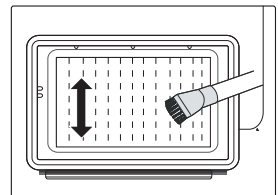

OPERATING INSTRUCTION

■ SPECIAL LAUNDRY TIPS

Items	Drying guide
Bedspreads & Comforters	<ul style="list-style-type: none">- Follow the care label instructions or dry in Bulky cycle.- Make sure the item is thoroughly dry before using or storing.- May require repositioning to ensure even drying.
Blankets	<ul style="list-style-type: none">- Use the Normal cycle and dry only one blanket at a time for best tumbling action.- Make sure the item is thoroughly dry before using or storing.- May require repositioning to ensure even drying.
Curtains & Draperies	<ul style="list-style-type: none">- Use the Casual cycle and less dry to help minimize wrinkling.- Dry these in small loads for best results and remove as soon as possible.
Cloth Diapers	<ul style="list-style-type: none">- Use the Normal cycle.
Down Filled Items (jackets, sleeping bags, comforters, etc.)	<ul style="list-style-type: none">- Use the Normal cycle.- Add a couple of dry towels to shorten drying time and absorb moisture.
Foam Rubber (rug backs, stuffed toys, shoulder pads, etc.)	<ul style="list-style-type: none">- DO NOT dry on a seat setting. Use the Air Fluff cycle (no heat). <p>WARNING: Drying a rubber item with heat may damage it or create a fire hazard.</p>
Pillows	<ul style="list-style-type: none">- Use the Normal cycle.- Add a couple of dry towels and a pair of clean sneakers to help the tumbling action and to fluff the item. <p>DO NOT dry kapok or foam pillows in the dryer. You can dry these items in the dryer as long as you use the air fluff cycle.</p>
Plastics (shower curtains, outdoor furniture covers, etc.)	<ul style="list-style-type: none">- Use the Air fluff cycle (no heat).

MAINTENANCE



WARNING

Certain internal parts are intentionally not grounded and may present a risk of electric shock only during servicing. Service Personnel – Do not contact the following parts while the appliance is energized: Main Motor , Cooling Fan.

■ CARE AND MAINTENANCE

Control panel

- Clean with a soft, damp cloth. Do not use abrasive substances.
- Do not spray cleaners directly on the panel.
- The control panel finish may be damaged by some laundry pre-treatment soil and stain remover products. Apply such products away from your dryer and wipe up any spills or overspray immediately.

Stainless steel or anonized drum

- To clean the stainless steel or anonized drum, use a damp cloth with a mild, non-abrasive cleaner suitable for stainless steel and anonized surfaces.
- Remove the cleaner residue and dry with a clean cloth.

Dryer exterior

- Clean with a soft, damp cloth. Do not use abrasive substances.
- Protect the surface from sharp objects.
- Do not place any heavy or sharp objects or a detergent box on the dryer. Keep them on the purchased pedestal or in a separate storage box. This may scratch or damage the top cover of the dryer.
- Since the entire dryer has a high-gloss finish, the surface can be scratched or damaged.
- Avoid scratching or damaging the surface when using the dryer.

TROUBLESHOOTING INSTRUCTIONS



■ CHECK THESE SOLUTIONS IF YOUR DRYER

If your dryer has any problems as followings, you can check as the solutions listed below before making a service call. This will help you save time and money.

Problem	Solution
The unit doesn't start	<ul style="list-style-type: none"> - Make sure the door is latched shut. - Be sure the power cord is plugged into a live electrical outlet. - Check the home's circuit breaker and fuses. - Press the Start/Pause button again if the door is opened during the cycle.
The unit doesn't heat	<ul style="list-style-type: none"> - Check the home's circuit breaker and fuses. - Select a heat setting other than Air fluff . - Clean the lint filter . - Dryer may have moved into the cool-down process of the cycle.
Doesn't dry	<ul style="list-style-type: none"> - Check the entire above, plus... - Do not overload. 1 wash load = 1 dry load. - Sort heavy items from lightweight items. - Large, bulky items like blankets or comforters may require repositioning to ensure even drying. - Load may be too small to tumble properly. Add a few towels.
The unit is noisy	<ul style="list-style-type: none"> - Check the load for objects such as coins, loose buttons, nails, broken zips, etc. Remove promptly. - It is normal to hear the dryer gas valve or heating element cycle on and off during the drying cycle. - Be sure the dryer is leveled properly as outlined in the installation instruction.
The remaining time changes abnormally	<ul style="list-style-type: none"> -The sensor cycle will estimate dampness of clothes automatically. Due to amount and material of clothes, to assure the expected dampness, the dryer will adjust remaining time, this is normal .



TROUBLESHOOTING INSTRUCTIONS

Problem	Solution
Clothes are unevenly dried	<ul style="list-style-type: none"> - Seams, pockets, and other similarly heavy areas may not be completely dry when the rest of the load has reached the selected dryness level. This is normal. Select the Time Dry setting if desired. - If one heavy item is dried with a lightweight load, such as one towel with sheets, it is possible that the heavy item will not be completely dry when the rest of the load has reached the selected dryness level. Sort heavy items from lightweight items for best drying results.
Shuts off before load is dry	<ul style="list-style-type: none"> - Household odors from painting, varnishing, strong cleaners, etc. may enter the dryer with surrounding room air. This is normal as the dryer draws the air from surrounding air space of the dryer locations. - When these odors linger in the air, ventilate the room completely before using the dryer.
Odors remain in clothing after refresh	<ul style="list-style-type: none"> - Fabrics containing strong odors should be washed utilizing desired wash cycle.
Garments still wrinkled after Wrinkle-prevent	<ul style="list-style-type: none"> - Small loads of 1 to 4 items work best. - Load fewer garments. Load similar-type garments.
Lint on clothes	<ul style="list-style-type: none"> - Lint filter be cleaned before every cycle. With some loads that produce high amounts of lint, it is necessary to clean the filter after the cycle. - Some fabrics are lint producers (for example, a fuzzy white cotton towel) and they should be dried separately from clothes that are lint trappers (for example, a pair of lack linen pants). - Divide larger loads into smaller loads for drying. - Check pockets thoroughly before washing and drying clothes.
"  " is lighting	<ul style="list-style-type: none"> - Clear lint filter.
"  " is flashing	<ul style="list-style-type: none"> - When the cycle is end, "  " will flash and dryer will beep 5 seconds. - Check the water container. If it's full, please pour out the condensate water and restart the dryer. - If the container is not full, please restart the dryer directly. - If the "water full" icon is still flashing after you have finished the first two steps, please call the service.

TROUBLESHOOTING INSTRUCTIONS

Problem	Solution
Degree of dryness was not reached or drying time too long	<ul style="list-style-type: none">- Clean lint filter.- Empty container.- Check drain hose.- Dryer installation place is too restricted.- Clean the moisture sensors.- Keep the Air inlet clean.- Use higher drying intensity level programme or time programme.

■ ERROR CODES



































Error Code	Possible Cause	Solutions
<i>E 32</i>	Humidity	Please contact your local service center if the problem occurs.
<i>E 33</i>	Temperature sensor error	
<i>E 64</i>	Motor communication error	
<i>E 82</i>	PCB communication error	

TROUBLESHOOTING INSTRUCTIONS

■ APPENDIX

Fabric Care Chart

The following symbols provide garment care direction. The Clothing care labels include symbols for washing, bleaching, drying and ironing, or dry cleaning when necessary. The use of symbols ensures consistency among garment manufacturers of domestic and imported items. Follow care label directions to maximize garment life and reduce laundering problems.

Wash Cycle		Special Instructions		Warning Symbols for laundering	
	Normal		Line Dry/ Hang to Dry		Do Not Wash
	Permanent Press / Wrinkle Resistant / Wrinkle Control		Drip Dry		Do Not Wring
	Gentle/Delicates		Dry Flat		Do Not Bleach
	Hand Wash	Heat Setting			Do Not Tumble Dry
Water Temperature**			High		No Steam (added to iron)
	Hot		Medium		Do Not Iron
	Warm		Low	Dryclean	
	Cold		Any Heat		Dry Clean
Bleach			No Heat/Air		Do Not Dry Clean
	Any Bleach (when needed)	Iron-Dry or Steam Temperatures			Line Dry/ Hang to Dry
	Only Non-Chlorine (color-safe) Bleach (when needed)		High		Drip Dry
	Tumble Dry Cycle		Medium		Dry Flat
Normal			Low		
	Permanent Press/ Wrinkle Resistant/ Wrinkle Control		For machine-washable wool. Loads should be under 8 pounds.		
	Gentle/ Delicates				

** The number of dots represent appropriate wash water temperatures for various items. The temperature range for Hot is 105°-125°F/41°-52°C, for Warm 85°-105°F/29°-41°C and for Cold 60°-85°F/16°-29°C.

Limited Warranty

Within the 48 contiguous United States, for one year from the date of purchase, when this appliance is operated and maintained according to instructions attached to or furnished with the product, warrantor will pay for factory-specified parts and repair labor to correct defects in materials or workmanship. Service must be provided by a designated service company. Outside the 48 states, all parts are warranted for one year from manufacturing defects. Plastic parts, shelves and cabinets are warranted to be manufactured to commercially acceptable standards, and are not covered from damage during handling or breakage.

ITEMS WARRANTOR WILL NOT PAY FOR:

1. Service calls to correct the installation of your appliance, to instruct you how to use your appliance, to replace or repair fuses or to correct wiring or plumbing.
2. Service calls to repair or replace appliance light bulbs or broken glass shelves. Consumable parts (such as filters) are excluded from warranty coverage.
3. Damage resulting from accident, alteration, misuse, abuse, fire, flood, acts of God, improper installation, installation not in accordance with electrical or plumbing codes, or use of products not approved by warrantor.
4. Replacement parts or repair labor costs for units operated outside the United States.
5. Repairs to parts or systems resulting from unauthorized modifications made to the appliance.
6. The removal and reinstallation of your appliance if it is installed in an inaccessible location or is not installed in accordance with published installation instructions.

DISCLAIMER OF IMPLIED WARRANTIES – LIMITATION OF REMEDIES

CUSTOMER'S SOLE AND EXCLUSIVE REMEDY UNDER THIS LIMITED WARRANTY SHALL BE PRODUCT REPAIR AS PROVIDED HEREIN. IMPLIED WARRANTIES, INCLUDING WARRANTIES OF MERCHANTABILITY OR FITNESS FOR A PARTICULAR PURPOSE, ARE LIMITED TO ONE YEAR. WARRANTOR SHALL NOT BE LIABLE FOR INCIDENTAL OR CONSEQUENTIAL DAMAGES. SOME STATES DO NOT ALLOW THE EXCLUSION OR LIMITATION OF INCIDENTAL OR CONSEQUENTIAL DAMAGES, OR LIMITATIONS ON THE DURATION OF IMPLIED WARRANTIES OF MERCHANTABILITY OR FITNESS, SO THESE EXCLUSIONS OR LIMITATIONS MAY NOT APPLY TO YOU. THIS WARRANTY GIVES YOU SPECIFIC LEGAL RIGHTS AND YOU MAY ALSO HAVE OTHER RIGHTS, WHICH VARY FROM STATE TO STATE.



WARNING: This product can expose you to chemicals including Nickel (Metallic) which is known to the State of California to cause cancer, birth defects or other reproductive harm.

For more information go to www.P65Warnings.ca.gov

Note: Nickel is a component in all stainless steel and some other metallic compositions.



AVERTISSEMENT : Ce produit peut vous exposer à des produits chimiques, y compris le nickel (métallisé), qui est connu de l'État de Californie pour causer le cancer, des anomalies congénitales ou d'autres problèmes de reproduction.

Pour plus d'informations, visitez le site www.P65Warnings.ca.gov

Remarque : Le nickel est un composant de tout acier inoxydable et d'autres compositions métalliques.

FELIX STORCH, INC.
770 Garrison Avenue
Bronx, New York 10474
Phone: (718) 893-3900
Fax: (844) 478-8799
www.summitappliance.com

SUMMIT

For parts and accessory ordering,
troubleshooting and helpful hints,
visit: www.summitappliance.com/support