

CHAMPION

POWER EQUIPMENT™

OWNER'S MANUAL & OPERATING INSTRUCTIONS



Electric Hoist

Single Line 440 lb./Double Line 880 lb.



MODEL NUMBER
18890

SAVE THESE INSTRUCTIONS
Important Safety Instructions
are included in this manual.

MADE IN CHINA
REV 18890-20151216

12039 Smith Ave.
Santa Fe Springs CA 90670
USA / 1-877-338-0999
www.championpowerequipment.com

Have questions or need assistance?

Do not return this product to the store!

WE ARE HERE TO HELP!

Visit our website:

www.championpowerequipment.com

for more info:

- Product Info & Updates
- Tech Bulletins
- Frequently Asked Questions
- Product Registration

– or –

Call our Customer Care Team Toll-Free at:

1-877-338-0999

FOR RESIDENTS OF CALIFORNIA:

WARNING: This product contains chemicals known to the State of California to cause cancer and birth defects and other reproductive harm.

*We are always working to improve our products. Therefore, the enclosed product may differ slightly from the image on the cover.

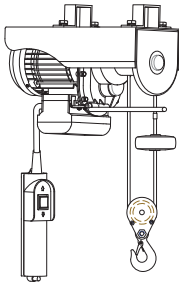

Electric Hoist

Single Line 440 lb./Double Line 880 lb.

TABLE OF CONTENTS

Introduction	1	Troubleshooting	13
Introduction	1	Specifications	14
This Booklet	1	Performance Specifications	14
Website	1	Parts Diagram	15
Manual Conventions	2	Parts List	16
Safety Rules	3	Warranty	17
Controls and Features	5	Warranty Qualifications	17
Electric Hoist	5	Repair/Replacement Warranty	17
Assembly	6	Do Not Return The Unit To The Place Of Purchase	17
Securing the Hoist	6	Warranty Exclusions	17
Surge Protection	6	Limits of Implied Warranty And Consequential Damage	17
Grounding	7	Contact Information	17
Extension Cord Information	7	Address	17
Electronic Hoist Location	7	Customer Service	17
Operation	8	Technical Service	17
Inspection	8		
Connecting a Load	8		
General Tips for Safe Operation	9		
Single Line Operation	9		
Double Line Operation	10		
Stop Bracket/Line Blocker	10		
Hoisting Techniques	11		
Maintenance	12		
Cleaning	12		
Lubrication	12		
Cable Assembly Replacement	12		
Storage	12		

INTRODUCTION

Introduction

Congratulations on your purchase of a Champion Power Equipment electric hoist. CPE designs and builds hoists to strict specifications. With proper use and maintenance, this hoist will bring years of satisfying service.

This Booklet

Every effort has been made to ensure the accuracy and completeness of the information in this manual. We reserve the right to change, alter and/or improve the product and this document at any time without prior notice.

Website

Champion Power Equipment manufactures and supports every product we sell. To find out more about your electric hoist please visit our website at:
→ www.championpowerequipment.com

Record the model and serial numbers as well as date and place of purchase for future reference. Have this information available when ordering parts and when making technical or warranty inquiries.

Champion Power Equipment Support
1-877-338-0999
Model Number
18890
Serial Number
Date of Purchase
Purchase Location

This manual uses the following symbols to help differentiate between different kinds of information. The safety symbol is used with a key word to alert you to potential hazards in operating and owning power equipment.

Follow all safety messages to avoid or reduce the risk of any damage, serious injury or death.

 **DANGER**

DANGER indicates an imminently hazardous situation which, if not avoided, **will** result in death or serious injury.

 **WARNING**

WARNING indicates a potentially hazardous situation which, if not avoided, **could** result in death or serious injury.

 **CAUTION**

CAUTION indicates a potentially hazardous situation which, if not avoided, **may** result in minor or moderate injury.

CAUTION

CAUTION used without the safety alert symbol indicates a potentially hazardous situation which, if not avoided, **may** result in property damage.

 **NOTE**

If you have questions regarding your hoist, we can help. Please call our help line at **1-877-338-0999**

SAFETY RULES

WARNING

Read this manual thoroughly before operating your hoist. Failure to follow instructions could result in damage, serious injury or death.

WARNING

Do not exceed the rated capacity.

DANGER

Do not use this hoist for lifting or moving people or animals.

DANGER

Keep yourself and others a safe distance to the side of the cable when under tension.

DANGER

Never step over or under a cable or near a cable under load.

WARNING

The wire cable may break before the motor stalls. For heavy loads at or near rated capacity, use a pulley block/snatch block to reduce the load on the wire cable.

WARNING

Hoist is meant for indoor use only, do not operate outside in wet conditions, rain or snow. Electric damage, shock or injury may occur if hoist is used outdoors or in wet environments.

WARNING

Do not use the hoist to secure an item(s) for transport.

WARNING

Unplug the power cord when not in use.

WARNING

Never leave an item(s) attached to the wire cable, lift hook, pulley hook, or loaded when not in use.

WARNING

Do not use for overhead lifting.

CAUTION

Use gloves to protect hands when handling the lift hook, pulley hook or cable. Never let the cable slide through your hands.

CAUTION

Do not wrap the cable around any object and hook it back onto itself.

DANGER

Do not operate if load is not centered under hoist. Do not hoist at any angles.

DANGER

Do not operate if cable is worn, frayed or appears damaged. Replace cable before use.

⚠ WARNING

When re-spooling the cable, ensure that the cable spools in the over-wind position with the cable entering the drum from the top, not the bottom.

To re-spool correctly, and while wearing gloves, keep a slight load on the cable while pushing the remote button to draw in the cable. Do not let your hands get within 12 in. (30.5 cm) of the hoist while re-spooling. Turn off the hoist and repeat the procedure until a few inches of cable are left before the stop bracket. Keep hands clear of the hoist, cable and slight load which hoist is under power.

⚠ WARNING

Never operate a damaged or malfunctioning hoist. If hoist appears damaged or is malfunctioning, disconnect power source and disconnect load.

⚠ DANGER

Do not lift any loads over people, animals, or property that cannot be damaged. Falling loads may result in property damage, injury or death.

⚠ WARNING

Do not modify the plug in any way or any outlet to fit the plug. Use only 3-prong grounding outlets and 3-wire extension cords with 3-prong grounding plugs.

⚠ WARNING

Any supporting structure the hoist will be mounted to must be designed to withstand any load or forces that the load and hoist may apply to the structure.

⚠ CAUTION

Duration of hoisting pulls should be kept as short as possible.

If the motor becomes uncomfortably hot to the touch, stop hoisting immediately and let it cool down for a few minutes. Do not pull for more than one minute at or near the rated load.

⚠ CAUTION

If the motor stalls, do not maintain power to the hoist.

Electric hoists are designed and made for intermittent use and should not be used in constant duty applications.

CAUTION

This hoist is for operation with 120V power sources only. 240V power sources will not power the hoist and may even damage the hoist. Make sure the power source for the hoist is a 120V 3-pronged grounded outlet only.

⚠ DANGER

Do not use damaged or broken equipment.

Before each use inspect the hoist and equipment for any damage to the following:

- Hoist
- Wire cable
- Lift hooks/Pulley hooks
- Power cord or plug prongs

If any of the above items or any other items appear to be damaged or broken then replace or fix before use.

CONTROLS AND FEATURES

Read this owner's manual before operating your hoist. Familiarize yourself with the location and function of the controls and features. Save this manual for future reference.

Electric Hoist

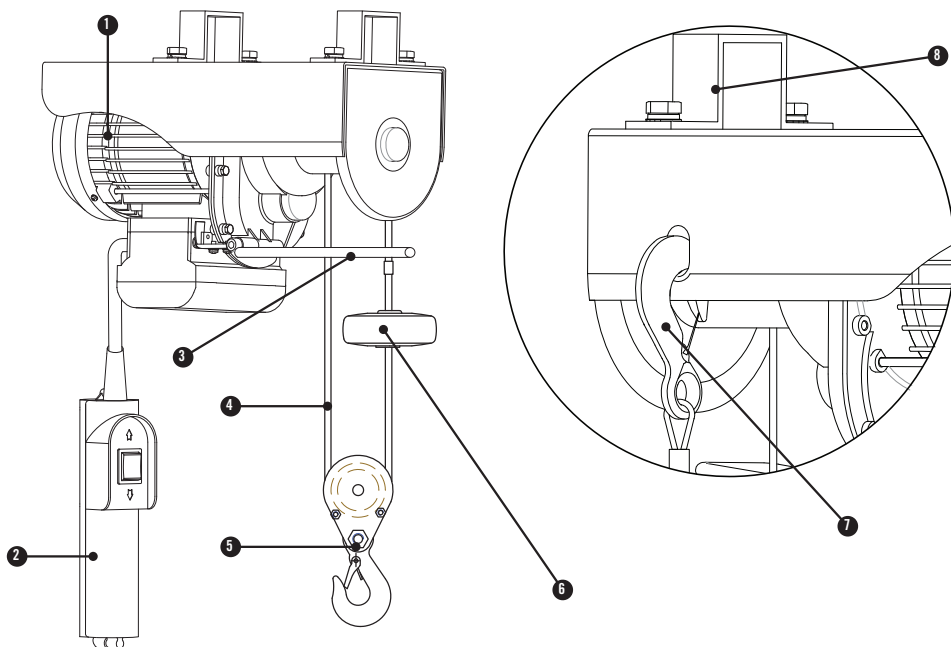

- | | |
|---|---|
| (1) Electric Motor – 7.1 Amp, 120V AC, Single Phase, 60 Hz. | (5) Pulley Hook – Used to support load for double line hoist. |
| (2) Remote Control – Used to retract or extend wire cable. | (6) Line Blocker – Used with Stop Bracket to stop wire cable from retracting too far into hoist. |
| (3) Stop Bracket – Used with Line Blocker to stop wire cable from retracting too far into hoist. | (7) Support Hook – Used to secure single or double line loads. |
| (4) Wire Cable | (8) Support Bracket – Used to secure hoist when mounted. |

Securing the Hoist

This CPE 440 lb./880 lb. electric hoist already comes with the remote control, power cord, wire cable and stop bracket attached, and therefore the user only needs to secure the hoist to a sturdy support structure using the support brackets provided.

1. Remove hoist and support brackets from packaging, being careful to set aside the mounting hardware needed.
2. Make sure the supporting structure for the hoist will be secure enough to support the hoist and any load that may be hoisted.

DANGER

Do not attached the hoist to any support structure that is not firmly secured in a straight up and down vertical position. The hoist must remain in a straight up and down vertical position while in use. Loads should NOT be hoisted at an angle.

CAUTION

Make sure the hoist is secured to a fixed support structure. It is NOT recommended to secure the hoist to a moveable support fixture.

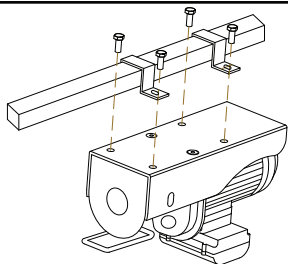

3. Place the support brackets over the structure.
4. Have a person or two help hold the hoist in position under the support brackets so the hoist is aligned with the holes in the support brackets.

Assembling the Hoist Cont'd.

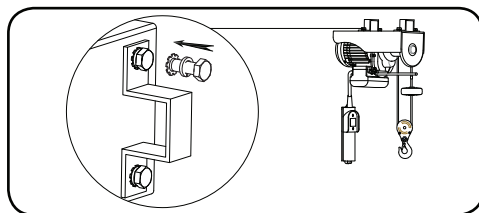

5. Thread the flat washer $\varnothing 10$ and lock washer $\varnothing 10$ onto the M10x26 bolt.
6. Insert the bolt through the support bracket and into the mounting hole in the top of the hoist. Hand tighten bolt.
7. Repeat for the remaining bolts on the two support brackets.
8. Once all the bolts have been hand tightened and the hoist is in the desired position, firmly tighten all bolts using a 16 mm wrench or socket (not included), until the hoist is secure.

CAUTION

The hoist must be secured with both support brackets (2) and all bolts (4). Do not try and secure a hoist to any structure with missing or damaged parts. Secure firmly before use.

Surge Protection

CAUTION

Voltage fluctuation may impair the proper functioning of sensitive electronic equipment.

While there is no way to prevent voltage fluctuations, electrical equipment may be protected by making sure your electrical equipment is connected to a surge protected outlet or with a rated surge protection device.

ASSEMBLY

Grounding

Your electronic hoist must be properly connected to an appropriate ground to help prevent electric shock.

WARNING

Failure to properly ground the electric hoist can result in electric shock.

A ground terminal prong connected to the power plug has been provided on the power cord. If grounding of the hoist is not properly understood, do not operate until grounding has been explained. We strongly recommend that you consult with a qualified electrician to ensure compliance with local electrical codes if grounding of the product is not fully understood. Improper connection of the equipment or the grounding conductor can result in electric shock. If the cord, plug, or outlet look damaged do not plug into a live terminal. Replace or fix any damaged cords, prongs, or outlets before use. Do not use any adapter or extension to connect the plug to a power source or outlet that is not grounded.

Extension Cord Information

If an extension cord must be used to power you electric hoist, please refer the minimum gauge of cord as it relates to feet needed.

Length	Gauge
25 ft. (7.6 m)	18 AWG Min.
50 ft. (15.2 m)	16 AWG Min.
100 ft. (30.5 m)	14 AWG Min.

WARNING

Use only 3-prong grounding outlets and 3-wire extension cords with 3-prong grounding plugs.

Electronic Hoist Location

A proper hoist work area is recommended. The hoist work area must be clean and well lighted. The work area must not be accessible to children or animals. Loads may be very heavy and property damage, injury or death may occur if distractions are present. Make sure the hoist is not installed on any support structure that is located overhead. OVERHEAD installation and use is NOT RECOMMENDED. The hoist should be located in an area that has enough clearance on all sides of it, to avoid any accidental breaking of the wire cable or dropping of the load.

Try to avoid the following dangers in any hoist work area.

- Overhead installation, use, and storage
- Any oils, liquids or other slipping hazards on the work area floor
- Confined spacing
- Distractions of any kind
- Dim or poor lighting

NOTE

Electric hoist is for indoor use only. Do not install, operate or store outdoors.

CAUTION

Make sure power cord and remote control cord are always out of the way of the load, and are never in a position to get frayed, pinched or damaged.

DANGER

Do not use if you have a pacemaker.

Electromagnetic fields in close proximity to a pacemaker may cause interference or failure of the pacemaker. People with pacemakers should:

- Consult a doctor before use
- Never operate alone
- Inspect hoist power cord for proper grounding connection and any signs of possible electric shock hazards

Inspection

Before use of the electric hoist, always inspect the hoist, power connections, wire cable, load connections, and work area for any possible damage or hazards. Never connect a load to or operate a hoist, if it or any of its parts appear to be worn or damaged.

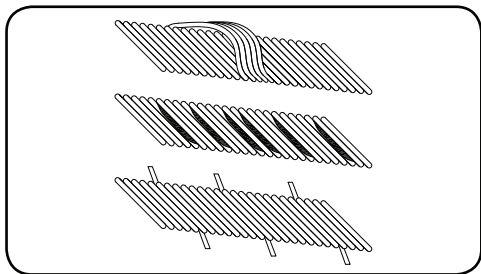

Always check the wire cable for any wear, fraying or damage. Only wire cable in good condition should be used. If the wire cable appears worn, frayed or damaged, DO NOT connect any load to or use, replace immediately.

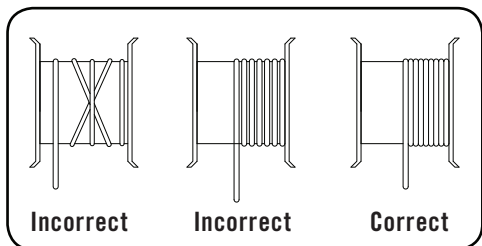

Inspect the wire cable to make sure it is spooled correctly. The wire cable should not be overlapping on itself, have space between the rolls or slack in it. If the wire cable is spooled incorrectly do not connect a load to it or use it until the wire cable has been re-spoiled correctly.

Connecting a Load

During connection of a load and operation of the hoist, the user should keep hands and fingers clear of pinch points, moving parts and the wire cable. Loose clothing and jewelry should not be worn during operation of the hoist. Gloves and safety goggles should be worn at all times when connecting or hoisting a load. The cable should never be allowed to slide through the users hands. The user should only grab the pulley or support hook when loading/unloading an item. Never grab the wire cable directly. Attach the load to the pulley or support hook using only rated equipment, such as slings, chains or hoisting shackles. Connection to the pulley or support hook must be completely secure to prevent any accidental disconnection. Make sure the lifting device is properly seated in the base of the hook and that the safety clasp closes fully.

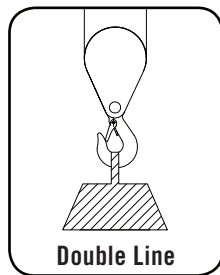
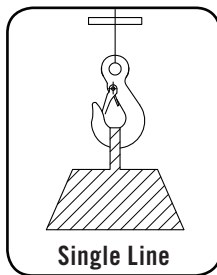

! CAUTION

If the wire cable becomes kinked or twisted during operation stop use immediately.

Once a load has been properly connected, make sure and do a test lift. Hoist the load 1 in. to 2 in. and pause a moment to inspect all connections and that the equipment can handle the load.

! WARNING

Do not exceed rated load capacity, even while testing a load.

OPERATION

General Tips for Safe Operation

Your 18890 electric hoist is rated at a 440 lb. single line and 880 lb. double line capacity. Overloads can damage the hoist, motor, wire cable, and/or create a possible hazard for property damage, injury or death.

For loads over 440 lb. (200 kg) the use of the pulley hook to double the wire cable line must be used. This will aid in two ways:

- (a) reduce the number or cable layers on the drum, as well as,
- (b) reduce the load on the wire cable by as much as 50%.

When doubling the line back to the hoist, run the wire cable through the pulley hook and attach to the support hook to the back side of the hoist frame.

Get to know your hoist before you actually need to use it. We recommend that you set up a few test runs to familiarize yourself with rigging techniques, the sounds your hoist makes under various loads, the way the cable spools on the drum, etc.

Inspect the wire cable and equipment before each use. A frayed or damaged cable shall be replaced immediately. Use only manufacturer's identical replacement cable with the exact specifications. Inspect the hoist installation and bolts to ensure that all bolts are tight before each operation. Store the hoist indoors and in a place that it will not be damaged.

Any hoist that appears to be damaged in any way, is found to be worn, or operates abnormally **MUST BE REMOVED FROM SERVICE UNTIL REPAIRED**. It is recommended that the necessary repairs be made by a manufacturer's authorized repair facility.

Only attachments and/or adapters supplied by the manufacturer are to be used.

Single Line Operation

During single line operation, the max rated load capacity is 440 lb. (200 kg). Do not exceed max rated load capacity. Single line loads can be connected with the support hook that comes already attached to the wire cable. The load can be directly connected to the support hook using a properly rated hoisting sling, chain or shackle. Make sure the load is directly underneath hoist and is not at an angle.

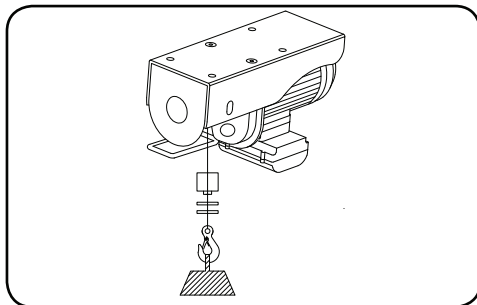

WARNING

Maintain at least 4 wraps (coils) of cable on the drum during operation. Operating with fewer than 4 wraps of cable on the drum can cause the cable to pull off the drum.

Double Line Operation

If any load is heavier than 440 lb. (200 kg.), then the double line technique must be used. During double line operation the max rated load capacity is 880 lb. (400 kg). Do not exceed max rated load capacity. During double line operation, the pulley hook must be spooled onto the wire cable. The support hook must be anchored on the back side of the hoist in the designated support hole built into the hoist frame. The hook must securely fit into the support hole, and the safety clasp must be able to fully close to lock the hook in place.

Double Line Operation Cont'd.

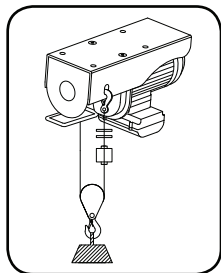
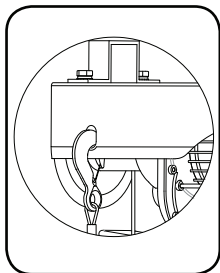

Once the support hook is securely hooked into the double line support hole and the safety clasp has been fully clasped, then the pulley hook can be attached to the wire cable. Please follow these steps for attaching the pulley hook to the wire cable.

1. Remove R-pin from the retaining bolt. (A)
2. Pull retaining bolt out of pulley hook, making sure all washers and hook are captured. (A)
3. Remove the nuts (2) and bolts (2) from the pulley. (B)
4. Place the pulley hook assembly (without the hook attached) onto the wire cable below the line blocker.
5. Make sure the pulley hook roller is aligned on the wire cable and is not in any way askew or oblong seated on the wire.
6. Test the alignment of the pulley hook by sliding it across the wire cable a few inches, back and forth.
7. Slide the bolts (2) back into the pulley and secure with nuts (2). (B)
8. Slide retaining pin back through the pulley, hook and all washers. (A)
9. Replace the R-pin into retaining pin to lock it in place. (A)
10. Test a small sample load on the pulley hook to make sure the connection is secure and pulley roller is aligned. Make sure the load is directly underneath hoist and is not at an angle.

Double Line Operation Cont'd.

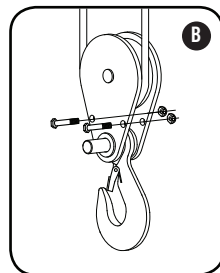
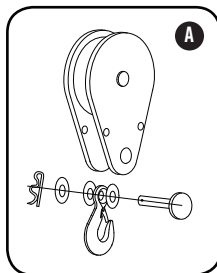

⚠ WARNING

If pulley hook roller is not properly aligned damage to the wire cable or accidental load dropping could occur.

⚠ WARNING

Maintain at least 4 wraps (coils) of cable on the drum during operation. Operating with fewer than 4 wraps of cable on the drum can cause the cable to pull off the drum.

Stop Bracket/Line Blocker

The stop bracket (A) is set up to automatically shut down the hoist if the line blocker (B) begins to pull it upwards. This helps prevent the wire cable from retracting too far on the spool and causing any damage to the spool, cable or hoist.

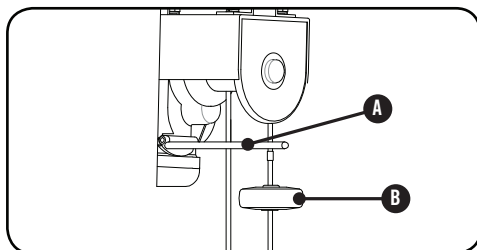

⚠ CAUTION

Do not try to re-position or remove the line blocker. It has been preset for safety reasons.

OPERATION

Hoisting Techniques

1. Take time to assess your work area, and make sure it is free of any debris, liquids, and other possible hazards and distractions.
2. Take time to assess your situation and plan your hoist.
3. Put on safety goggles to protect your eyes, gloves to protect your hands, steel toe boots to protect your feet and a hard hat to protect your head.
4. Inspect hoist, power cords and wire cable for excessive wear or damage.
5. Plug power supply into a properly grounded outlet or extension cord with a grounded receptacle and plug.
6. Test the hoist without a load connected. Make sure the wire cable descends and ascends properly without any problems.
7. Connect desired load using only properly rated hoisting slings, chains or shackles.
8. Double check your anchors and make sure all connections are secure.
9. Clear the area. Make sure all operators and bystanders stand clear and that no one is directly above or underneath the load or within 12 in. (30.5 cm) of the wire cable.
10. Begin hoisting. Be sure that the wire cable is winding evenly and tightly around the drum. Avoid shock loads; keep the wire cable under tension.
11. The hoist is meant for intermittent use. Under full load with a single line rig do not power in/out for more than 2 minutes, 30 seconds without letting the motor cool down for 7 minutes, 30 seconds and then resume the hoisting operation.
12. If the hoist must be stopped, with a load connected to it, support anchors should be placed under the load until the hoist is going again.
13. The hoisting operation is complete once the load is on stable ground or has anchors for support placed under it.

Hoisting Techniques Cont'd.

14. Disconnect the wire cable from the anchor.
15. Rewind the wire cable. Make sure that any wire already on the drum has spooled tightly and neatly. If not, draw out the wire and re-spool from the point where the cable is tight.
16. Keep your hands clear of the hoist drum and fairlead as the wire cable is being drawn in.
17. Secure the hook and hook strap.
18. Clean and inspect connections and mounting hardware for next hoisting operation.

DANGER

Users and bystanders must keep a minimum distance of 12 in. (30.5 cm) at all times from the hoist and load. If the wire cable breaks serious injury or death could occur if the broken cable "whips" around. More distance is advised as the cable length increases.

WARNING

Support anchors are highly recommended if a load can not be placed on stable ground. Make sure the support anchors can withstand the full weight of the load being anchored.

The owner/operator is responsible for all periodic maintenance.

WARNING

Never operate a damaged or defective hoist.

WARNING

Improper maintenance will void your warranty.

Complete all scheduled maintenance in a timely manner. Correct any issue before operating the hoist.

NOTE

For service or parts assistance, contact our help line at **1-877-338-0999**

Cleaning

Use a damp cloth to clean the exterior surfaces of the hoist. Use a soft bristle brush to remove excess dirt and oil. Use an air compressor (25 PSI) to clear dirt and small debris from the wire cable spool and other tight places.

CAUTION

DO NOT spray water directly on the hoist or wire cable. DO NOT wipe the wire cable with the damp cloth. Use only compressed air to clean the wire cable.

Lubrication

All moving parts within the Electric Hoist having been Lubricated using high temperature lithium grease at the factory. No internal lubrication is required. Lubricate cable assembly periodically using a light penetrating oil.

Cable Assembly Replacement

It is recommended that any wire cable or spool modifications be performed by a manufacturer's authorized repair facility, and that only manufacturer-supplied parts be used.

Storage

It is recommended the electric hoist is stored indoors, in a clean dry place, free from sunlight and moisture.

1. Make sure the hoist is properly cleaned before storage.
2. Make sure the wire rope is drawn onto the spool as much as it can be without damage.
3. Make sure to tie up all cords.
4. Store in a place that moisture can not damage the hoist.
5. Store in place that excess dust or debris can not damage the hoist.

TROUBLESHOOTING

Problem	Cause	Solution
Motor does not click or turn	No electrical power	Plug in and secure power cord to a grounded electrical 120V power source
	Pinched power cable	Check all power cord connections and make sure nothing is resting on top of, or pinching the power cord
	Defective remote control	Replace remote control
Motor runs slowly or without normal power	Insufficient current or voltage	The voltage supply is weak. Check to make sure voltage supply is 120V
Motor overheating	Hoist running time is too long	Allow hoist to cool down
Motor runs in one direction only	Defective remote assembly	Replace remote assembly

For further technical support:

Technical Service

Mon – Fri 8:30 AM – 5:00 PM (PST/PDT)

Toll Free: 1-877-338-0999

tech@championpowerequipment.com

Performance Specifications

- Single Line Rated Pull	440 lb. (200 kg)
- Double Line Rated Pull	880 lb. (400 kg)
- Lifting Speed	33 ft./Per Minute (single line) 16.5 ft./Per minute (double line)
- Lifting Height	38 ft. (single line) 19 ft. (double line)
- Motor	120V AC, Single Phase, 60 Hz
- Current	7.1 Amps
- Power	850W
- Duty Cycle	*S3 25%
- Cable	9/64 in. (D) x 39.4 ft. (L) [3.8 mm (D) x 12 m (L)]
- Gross Weight	37.5 lb. (17 kg)
- Net Weight	35.3 lb. (16 kg)
- Height	8.8 in. (22.4 cm)
- Width	5.7 in. (14.5 cm)
- Length	14.6 in. (37.2 cm)

*Do not pull for more than 2 minutes, 30 seconds. Before 2 minutes, 30 seconds, stop hoisting and let it cool down for 7 minutes, 30 seconds. Electric hoists are designed and made for intermittent use and should not be used in constant duty applications.

SPECIFICATIONS

Parts Diagram

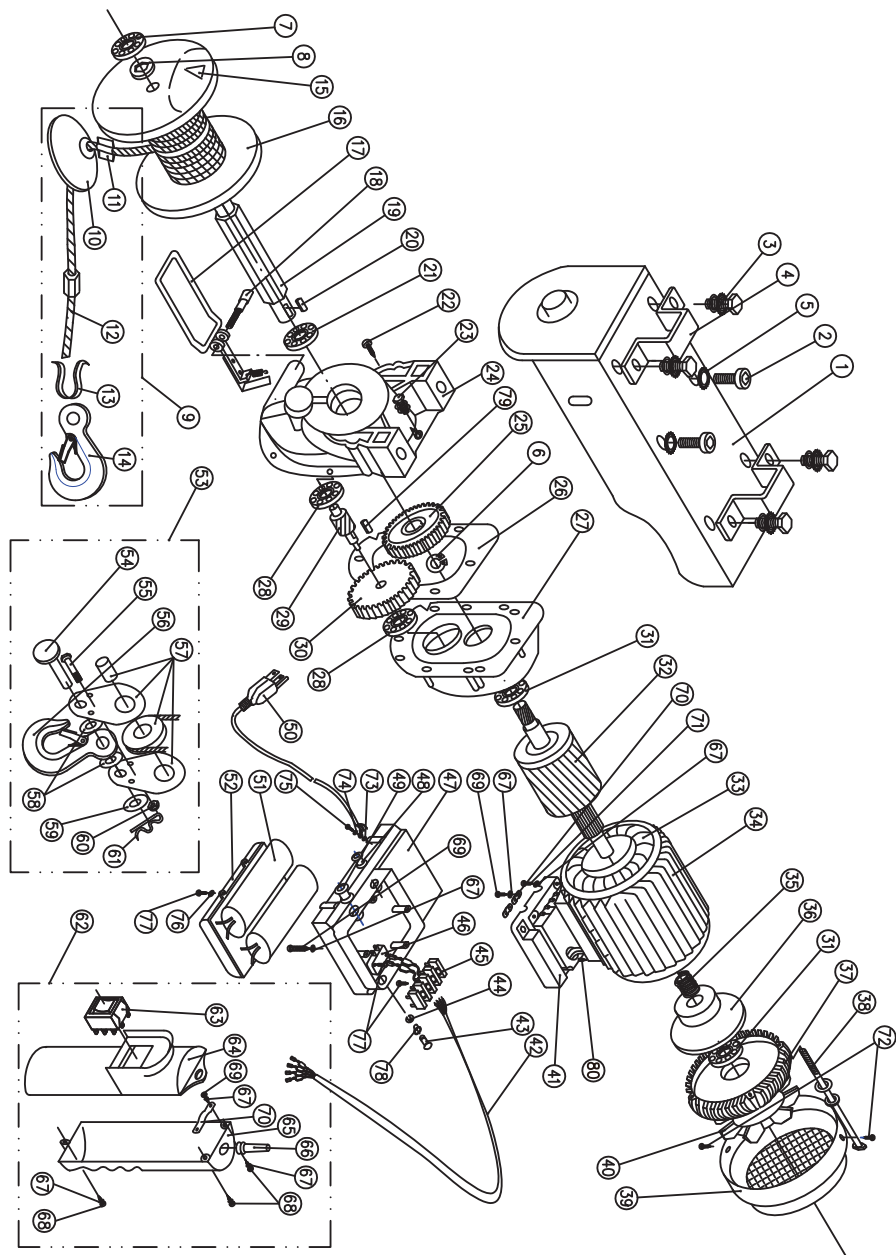

#	Part Number	Description	Qty
1	18890-001	Housing	1
2	18890-002	Cap Screw (M10 x 30)	2
3	18890-003	Assembling Bolt (M10 x 26)	4
4	18890-004	Fixing Ring	2
5	18890-005	Lock Washer-Teeth (ø10)	2
6	18890-006	Circlip (ø17)	1
7	18890-007	Bearing (6003RS)	1
8	18890-008	Washer	1
9	18890-100	Wire Rope Assembly	1
10	18890-009	Rope Block	1
11	18890-010	Rope Crimp	2
12	18890-011	Wire Rope	1
13	18890-012	Rope Thimble	1
14	18890-013	Rope Hook	1
15	18890-014	Rope Wedge	1
16	18890-015	Drum	1
17	18890-016	Stop Bracket	1
18	18890-017	Cap Screw (M8x45)	1
19	18890-018	Drum Shaft	1
20	18890-019	Key (5x16)	1
21	18890-020	Bearing (6203RS)	1
22	18890-021	Cross Head Bolt (M5x16)	2
23	18890-022	Assembling Bolt (M5x17)	6
24	18890-023	Gearbox	1
25	18890-024	Secondary Gear	1
26	18890-025	Gasket	1
27	18890-026	Front Cover	1
28	18890-027	Bearing (6201)	2
29	18890-028	Idler Gear	1
30	18890-029	Primary Gear	1
31	18890-030	Bearing (6202RS)	2
32	18890-031	Rotor	1
33	18890-032	Stator	1
34	18890-033	Motor Housing	1
35	18890-034	Spring	1
36	18890-035	Brake Drum	1
37	18890-036	Motor Cover	1
38	18890-037	Assembling Bolt (M5 x 154)	4
39	18890-038	Fan Hood	1
40	18890-039	Fan Blade	1

#	Part Number	Description	Qty
41	18890-040	Upper Junction Box	1
42	18890-041	Cable	1
43	18890-042	Limit Switch Shaft	1
44	18890-043	Split Washer (ø6)	1
45	18890-044	Terminal Block	1
46	18890-045	Limit Switch	1
47	18890-046	Junction Box	1
48	18890-047	Strain Relief Bushing (S)	1
49	18890-048	Strain Relief Bushing	1
50	18890-049	Power Cord	1
51	18890-050	Capacitor	1
52	18890-051	Junction Box Cover	1
53	18890-200	Pulley Assembly	1
54	18890-052	Pin	1
55	18890-053	Bolt (M5x30)	2
56	18890-054	Hook	1
57	18890-055	Pulley	1
58	18890-056	Plastic Washer	2
59	18890-057	Washer (ø10)	1
60	18890-058	Lock Nut (M5)	2
61	18890-059	R Pin	1
62	18890-300	Switch Assembly With Cable	1
63	18890-060	Switch	1
64	18890-061	Handle Cover	1
65	18890-062	Handle Housing	1
66	18890-063	Cord Sheath	1
67	18890-064	Washer (ø4)	17
68	18890-065	Tapping Screw (ST3.5x18)	3
69	18890-066	Tapping Screw (ST3.5x16)	10
70	18890-067	Cable Clamp	3
71	18890-068	Screw (M4x12)	4
72	18890-069	Screw (M3x6)	2
73	18890-070	Lock Washer-Teeth (ø4)	1
74	18890-071	Lock Washer (ø4)	1
75	18890-072	Screw (M4x8)	1
76	18890-073	Washer (ø3)	4
77	18890-074	Tapping Screw (ST2.9x14.7)	8
78	18890-075	Switch Shaft Sheet	1
79	18890-076	Key (5x12)	1
80	18890-077	Socket (M6x8)	1

WARRANTY

WARRANTY

CHAMPION POWER EQUIPMENT
2 YEAR LIMITED WARRANTY

Effective September 1, 2006. Replaces all undated warranties and all warranties dated before September 1, 2006.

Warranty Qualifications

Champion Power Equipment (CPE) will register this warranty upon receipt of your Warranty Registration Card and a copy of your sales receipt from one of CPE's retail locations as proof of purchase.

Please submit your warranty registration and your proof of purchase within ten (10) days of the date of purchase.

Repair/Replacement Warranty

CPE warrants to the original purchaser that the mechanical and electrical components will be free of defects in material and workmanship for a period of one year (parts and labor) and two years (parts) from the original date of purchase (90 days (parts and labor) and 180 days (parts) for commercial & industrial use). Transportation charges on product submitted for repair or replacement under this warranty are the sole responsibility of the purchaser. This warranty only applies to the original purchaser and is not transferable.

Do Not Return The Unit To The Place Of Purchase

Contact CPE's Technical Service and CPE will troubleshoot any issue via phone or e-mail. If the problem is not corrected by this method, CPE will, at its option, authorize evaluation, repair or replacement of the defective part or component at a CPE Service Center. CPE will provide you with a case number for warranty service. Please keep it for future reference. Repairs or replacements without prior authorization, or at an unauthorized repair facility, will not be covered by this warranty.

Warranty Exclusions

This warranty does not cover the following repairs and equipment:

Normal Wear

Hoists need periodic parts and service to perform well. This warranty does not cover repair when normal use has exhausted the life of a part or the equipment as a whole.

Installation, Use and Maintenance

This warranty will not apply to parts and/or labor if this hoist is deemed to have been misused, neglected, involved in an accident, abused, loaded beyond the hoist's limits, modified, installed improperly or connected incorrectly to any electrical component. Normal maintenance is not covered by this warranty.

Other Exclusions

This warranty excludes: The hoist cable. Cosmetic defects such as paint, decals, etc. Accessory parts such as storage covers. Failures due to acts of God and other force majeure events beyond the manufacturer's control. Problems caused by parts that are not original Champion Power Equipment parts.

Limits of Implied Warranty and Consequential Damage

Champion Power Equipment disclaims any obligation to cover any loss of time, use of this product, freight, or any incidental or consequential claim by anyone from using this hoist. THIS WARRANTY IS IN LIEU OF ALL OTHER WARRANTIES, EXPRESS OR IMPLIED, INCLUDING WARRANTIES OF MERCHANTABILITY OR FITNESS FOR A PARTICULAR PURPOSE

A unit provided as an exchange will be subject to the warranty of the original unit. The length of the warranty governing the exchanged unit will remain calculated by reference to the purchase date of the original unit. This warranty gives you certain legal rights which may change from state to state. Your state may also have other rights you may be entitled to that are not listed within this warranty.

Contact Information

Address

Champion Power Equipment, Inc.
Customer Service
12039 Smith Ave.
Santa Fe Springs, CA 90670
www.championpowerequipment.com

Customer Service

Mon – Fri 8:30 AM – 5:00 PM (PST/PDT)
Toll Free: 1-877-338-0999
info@championpowerequipment.com
Fax no.: 1-562-236-9429

Technical Service

Mon – Fri 8:30 AM – 5:00 PM (PST/PDT)
Toll Free: 1-877-338-0999
tech@championpowerequipment.com