

SEARS Kenmore

CONTENTS

SAFETY

..... 1-3

USE AND CARE

Your Oven and Its Features 4
Oven Controls 5-7
Clock 6
Timer 6
To Bake and Timed Baking 7
Oven Cooking 8
Broiling 9

CLEANING TIPS

..... 10

REMOVABLE PARTS

..... 11

SERVICE

Before Calling For Service 12
Thermostat Adjustments 13

WARRANTY

MODELS 40121
 40129

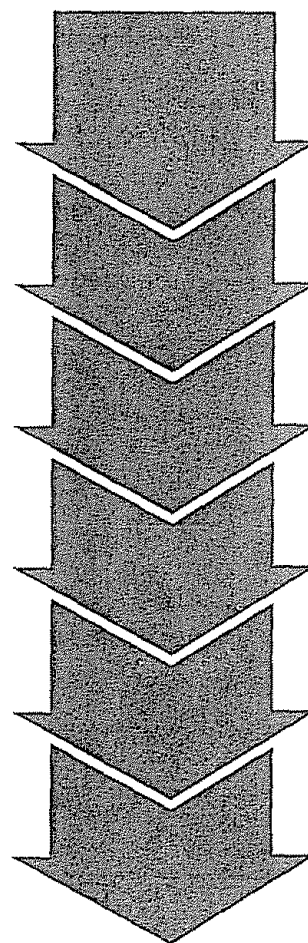

USE • CARE • SAFETY MANUAL



MNM171-3 SR10126 (347152)

IMPORTANT IMPORTANT IMPORTANT IMPORTANT IMPORTANT IMPORTANT IMPORTANT IMPORTANT IMPORTANT

IMPORTANT INSTRUCTIONS FOR YOUR SAFETY

SAVE THESE INSTRUCTIONS

Read all instructions before using this appliance. When using electrical appliances, basic safety precautions should be followed, including the following:

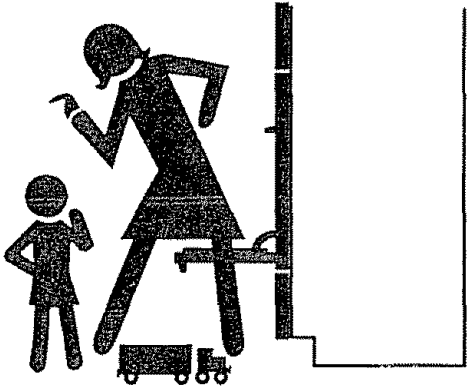

Teach children not to play with oven knobs or any other part of the oven.
Never leave children alone or unattended where an oven is in use.

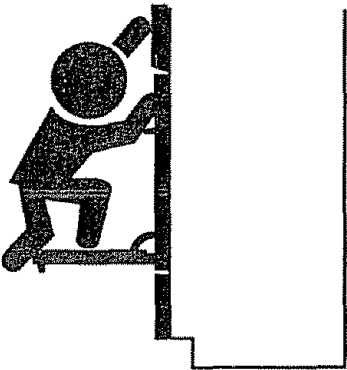

Never store things children might want above an oven.
Never let anyone climb, sit or stand on the open door or any other part of the oven.



Never leave the oven door open when you are not watching the oven.

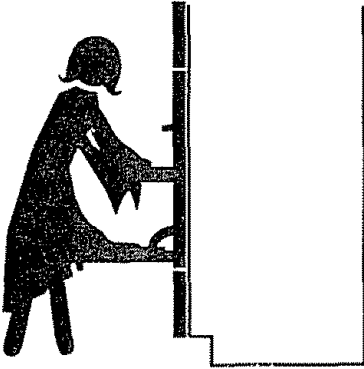

Never wear loose clothing when using your oven. Such clothing could catch fire.



IMPORTANT
IMPORTANT
IMPORTANT
IMPORTANT
IMPORTANT
IMPORTANT
IMPORTANT
IMPORTANT
IMPORTANT
IMPORTANT
IMPORTANT

To insure safety for yourself and your home, please read your Owner's Manual carefully. Keep it handy for quick easy reference. Pay close attention to the safety sections of your manual. You can recognize the safety sections by looking for the  symbol or the word "Safety".

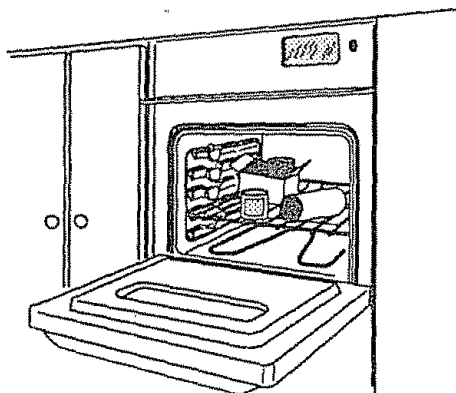

Always keep the oven area clear and free from things that will burn.

CAUTION:

Never store things in an oven. These things may catch fire and plastic items could melt.

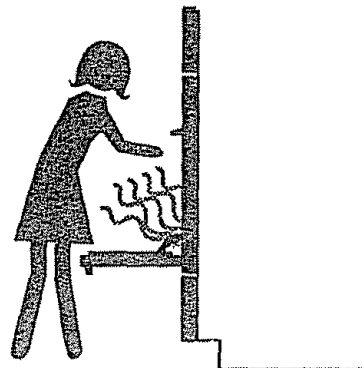

Never use your oven for warming or heating a room. You could be burned or seriously injured. Such misuse could also cause damage to the oven.

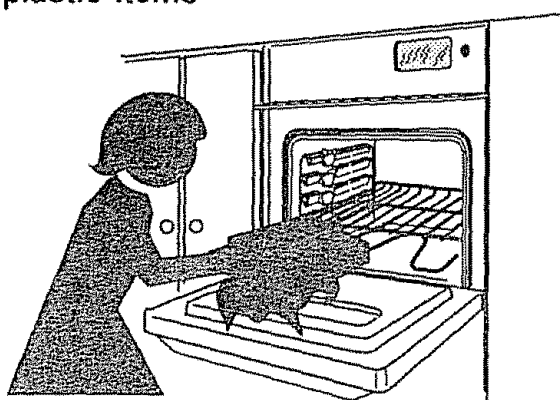

Never use a towel or other bulky cloth as a potholder. Such cloths could catch fire on a hot element.

IMPORTANT SAFETY INSTRUCTIONS

Keep this book for later use.

Be sure your oven is installed and grounded properly by a qualified technician.

Always use care when touching oven heating elements or inside the oven. Heating elements could be hot enough to burn you even if they are dark in color. The oven vent duct and oven door may also become hot during oven use.

Always keep the appliance area clear and free from things that will burn, gasoline and other flammable vapors and liquids.

After broiling, always take the broiler pan out of the oven and clean it. Leftover grease in the broiler pan can catch on fire next time you use the pan.

Always use dry potholders when removing pans from the oven. Moist or damp potholders can cause steam burns.

Always use care when opening oven door. Let hot air and steam out before moving food.

Always follow cleaning instructions in this book.

Always keep the oven clean. Food and grease are easy to ignite. Clean the oven regularly.

Always keep combustible wall coverings, curtains or drapes a safe distance away from your oven.

Always keep dish towels, dish cloths, potholders and other linens a safe distance away from your oven. Never store such items on your oven.

Place oven rack in desired position while oven is cool. If rack must be moved while oven is hot, do not let potholder contact hot heating element in oven.

Never try to repair or replace any part of the oven unless instructions are given in this book. All other work should be done by a qualified technician.

Never heat unopened food containers. Pressure build-up may make container burst and cause injury.

Never leave jars or cans of fat or drippings on or near the oven. Never let grease build up on your oven. You can keep grease fires from starting if you clean up grease and spills after each oven use.

Never use aluminum foil to line oven bottoms. Improper use of foil could start a fire.

Never block free airflow through the oven vent.

Never try to move a pan of hot fat, especially a deep fat fryer. Wait until the fat has cooled.

Never use your oven for warming or heating a room. Such use can be dangerous and can damage oven parts.

Never use a towel or other bulky cloth as a potholder. Such cloths could catch fire on a hot element.

Never store things in an oven.

Never store wooden or plastic utensils or canned food in your oven. Always keep such items a safe distance away from your oven.

Never touch the heating elements or interior surfaces of the oven. They may be hot even though they are dark in color.

Be sure the oven is securely installed in a cabinet that is firmly attached to the house structure. Weight on the oven door could cause the oven to tip and result in injury. Never allow anyone to climb, sit, stand or hang on the oven door.

FIRE!

Be sure everyone in your home knows what to do in case of fire.

Read and understand this information NOW!

Should you ever need it, you will not have time for reading.

Never use water on a grease fire - it will only spread the flames.

OVEN FIRE

Do not try to move the pan.

- 1. Close oven door and turn controls off.**
- 2. If fire continues, throw baking soda on the fire or use a dry chemical foam, or halon type extinguisher.**

YOUR BUILT-IN OVEN

IMPORTANT:

The model and serial number of your oven can be found on a tag, on the left side of the oven front frame.

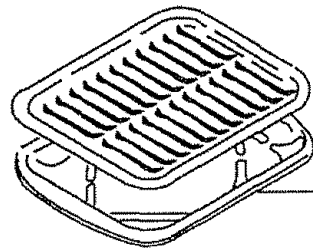
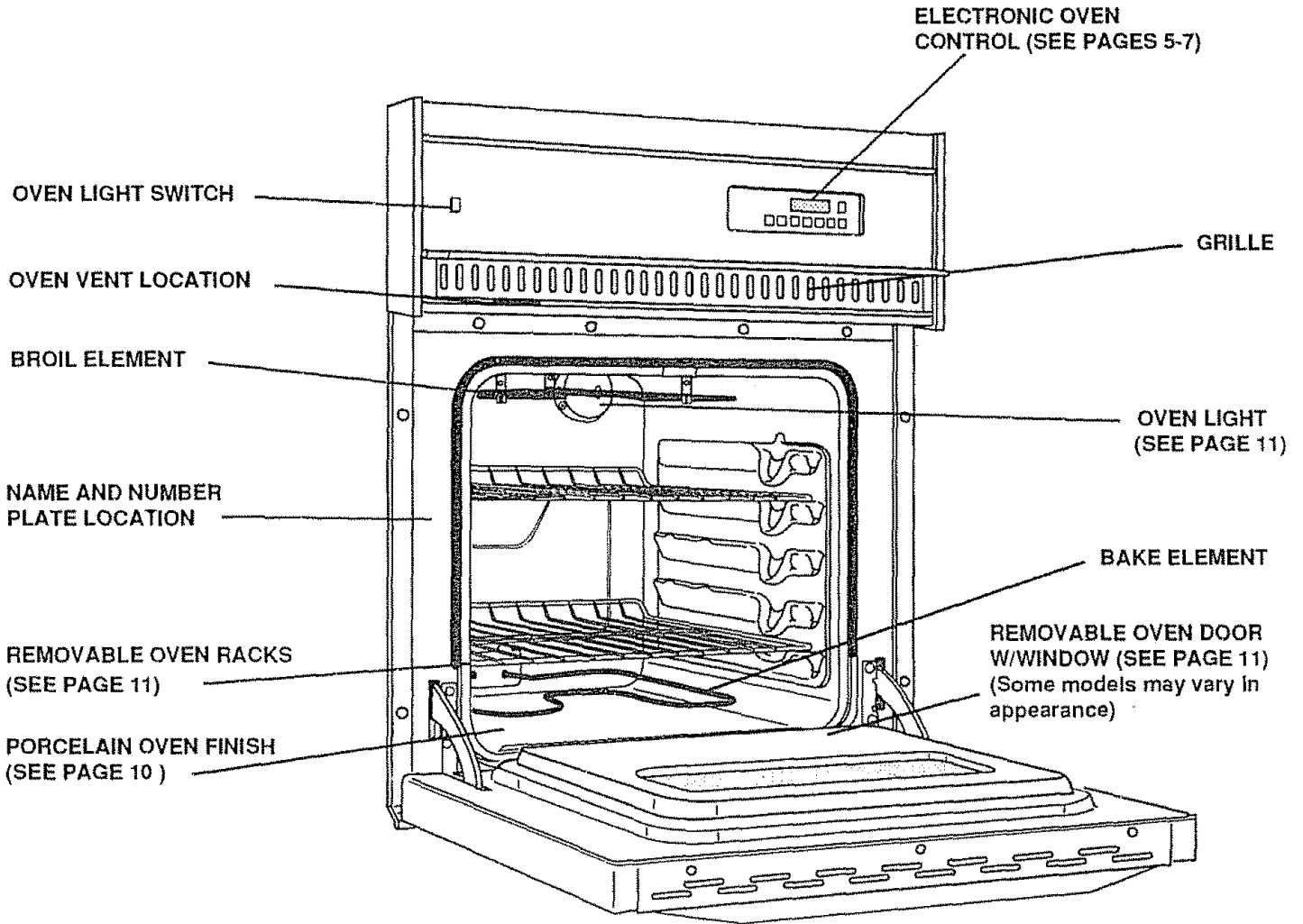

BROILER PAN & GRID
(SEE PAGES 9 & 10)

OVEN CONTROL

Read this page to become familiar with the control. The next two pages will explain how to set the different operations of your control.

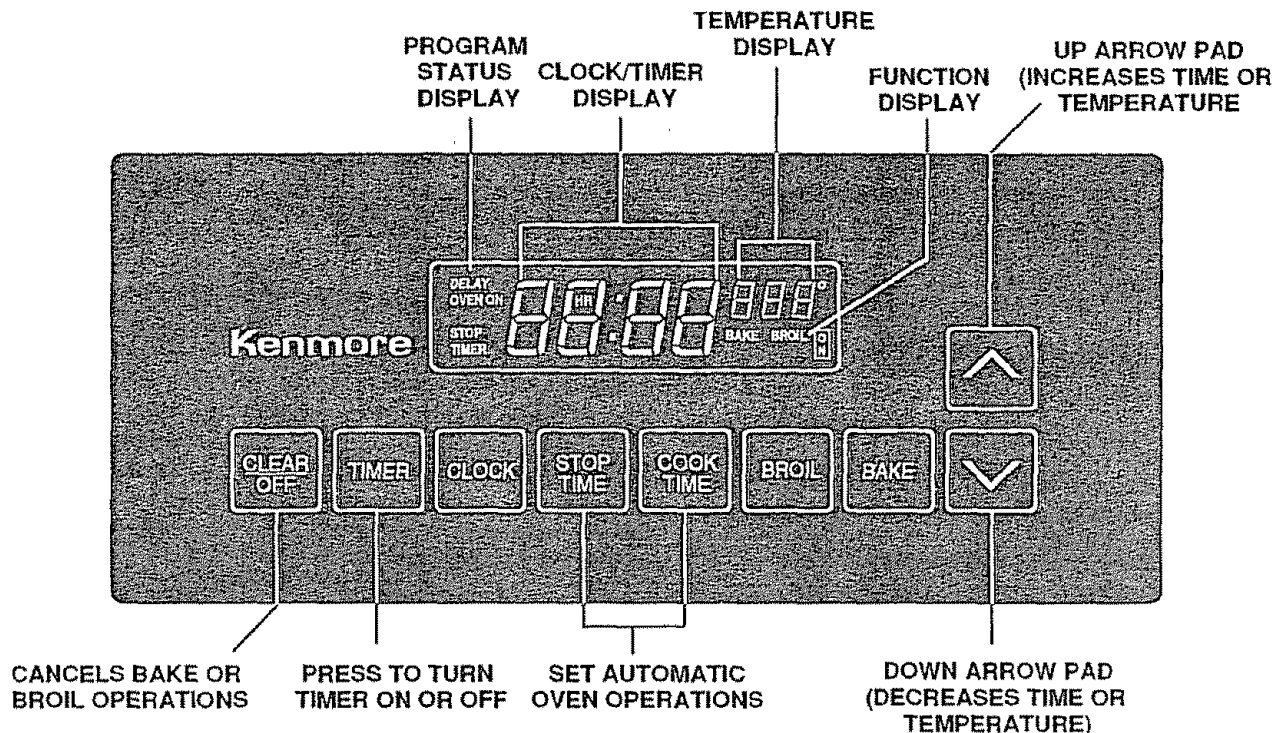

Your range control is touch controlled. To set bake, broil, or timer, touch the desired function pad and select the temperature or time by touching the arrow pad.

DISPLAY:

Programmed information can be displayed at any time by pressing the operation you wish to see. For example, you can display the current time of day by pressing **CLOCK**.

TONES:

The end-of-cycle tone will sound at the end of timed oven functions. The end-of-cycle tone is 3 short beeps followed by 1 beep every 6 seconds that repeat every 6 seconds until you press any operation. If you would like to eliminate the 1 beep every 6 seconds, push and hold **CLEAR/OFF** for 10 seconds.

To return the 1 beep every 6 seconds, push and hold **CLEAR/OFF** for 10 seconds.

See the following page(s) for instructions.

F CODE:

NOTE:

If the time display flashes **F** - any number, you have a function error code. Note the number after the **F**. Press **CLEAR/OFF**. Disconnect all power to the range. Advise your service technician of the **F**-number.

CLOCK:

1. Press **CLOCK**. The word "TIME" will flash in the display.
2. Press the **UP** or **DOWN** arrow pad to set the time.

Press and release for slow changes. Hold for fast changes.

***Note: The time of day cannot be changed during an active TIMED BAKE CYCLE.**

You can display the time of day at any time during oven operations by pressing **CLOCK**. See Fig. 1.

TIMER:

***Note: The timer does not control oven operations. The maximum time setting is 9 hours and 55 minutes.**

1. Press **TIMER**. "TIMER" will flash in display
2. Press and release the **UP** arrow pad for slow changes in time. Hold down for fast changes in time.

The TIMER display will increase as follows:

:10	TEN SECONDS	SEE FIG. 2
1:00	ONE MINUTE	SEE FIG. 3
1 HR:00	ONE HOUR	SEE FIG. 4

When the timer reaches 1 hour, the display will change. "HR" will appear in the display. Hours:Minutes will be displayed. See Fig. 4.

Note: Press and release OR hold the **DOWN** arrow pad to decrease time.

TO RESET TIMER:

"TIMER" will stop flashing and the **TIMER** will start counting down a few seconds after you stop using up or down. If you pause while selecting the time and the **TIMER** activates, press **TIMER** again and continue to set the time.

TO CANCEL TIMER:

After **TIMER** begins to count down, press and hold **TIMER** in at least four (4) seconds until "TIMER" quits flashing.

BROIL:

1. Press **BROIL**. "Broil" will flash and (- - -) will appear in display.
2. Select **LO Broil** by pressing the **UP** arrow pad one time. Select **HI Broil** by pressing the **UP** arrow pad twice. To change from **HI Broil** to **LO Broil**, press the **DOWN** arrow pad.

***Note: You cannot set a Delayed Broil Cycle.**

After **Broil** is finished, press **CLEAR/OFF**.

To reset **BROIL**, repeat Steps 1-2

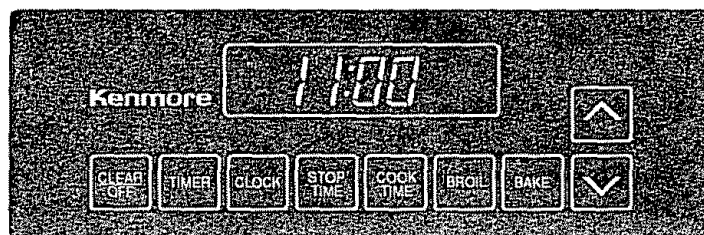
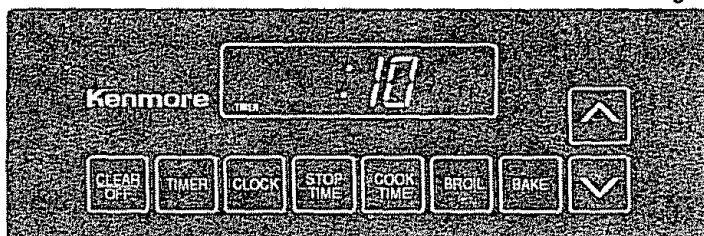
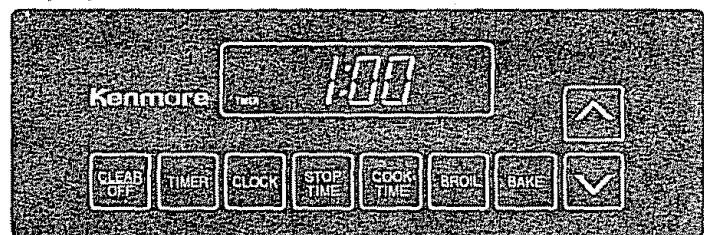

Fig. 1



Displays ten seconds

Fig. 2



Displays one minute: zero seconds

Fig. 3

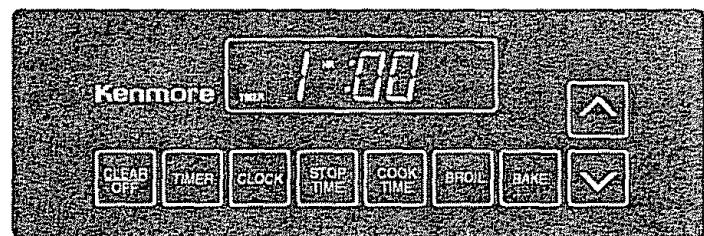

Displays one hour: zero minutes

Fig. 4

NOTE: Press "CLOCK" or "TIMER" to stop the End-of-Cycle tone.

PRESS ONCE TO SET LOW BROIL
PRESS TWICE TO SET HI BROIL

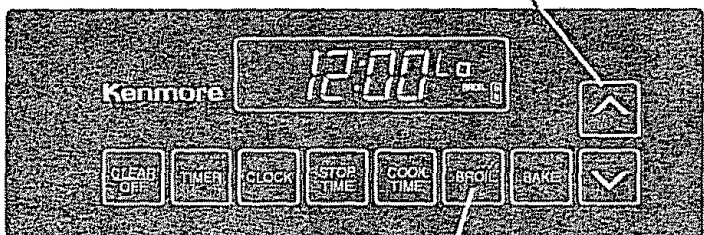

1 BROIL PAD

Fig. 5

BAKE:

1. Press **BAKE**. "BAKE" will flash and (- - - °) will appear in display.
2. Press the **UP** arrow. The display will show 150° the first time power is supplied to the oven. The display will show the last used bake temperature the next time you set BAKE. Quickly, adjust to the temperature you want using the **UP** or **DOWN** arrow pad.

NOTE: The display will show **ON** and the oven temperature as it heats up. When the oven reaches the set temperature a tone will sound. See Fig. 6.

To change the temperature during a **BAKE** cycle, repeat steps 1-2 under **BAKE**. After **BAKE** is finished press **CLEAR/OFF**.

AUTOMATIC OVEN OFF:

You can begin baking now and set the oven to turn off automatically.

1. Press **COOK TIME** (how long food is to cook).
2. Press the **UP** or **DOWN** arrow pad to set how long you want to bake.
3. Press **BAKE**.
4. Select the temperature using the **UP** or **DOWN** arrow pad. See Fig. 7.

NOTE: You should consider that food will continue to cook after controls turn off unless you remove the food immediately.

AUTOMATIC OVEN ON AND OFF:

You can set the oven to turn on and off automatically. The control will calculate the time to start cooking.

1. Press **COOK TIME** (how long food is to cook).
2. Press the **UP** or **DOWN** arrow pad to set how long you want to bake.
3. Press **STOP TIME**. The earliest stop time you can set will appear in the display.
4. Set **STOP TIME** (The time of day when you want the oven to turn off) using the **UP** or **DOWN** arrow pad.
5. Press **BAKE**.
6. Select the temperature using the **UP** or **DOWN** arrow pad. See Fig. 8.

NOTE: If control beeps, you have not completed your timed oven setting.

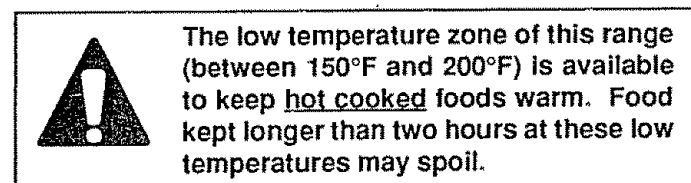
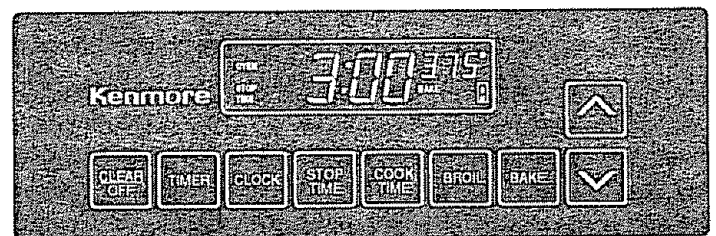
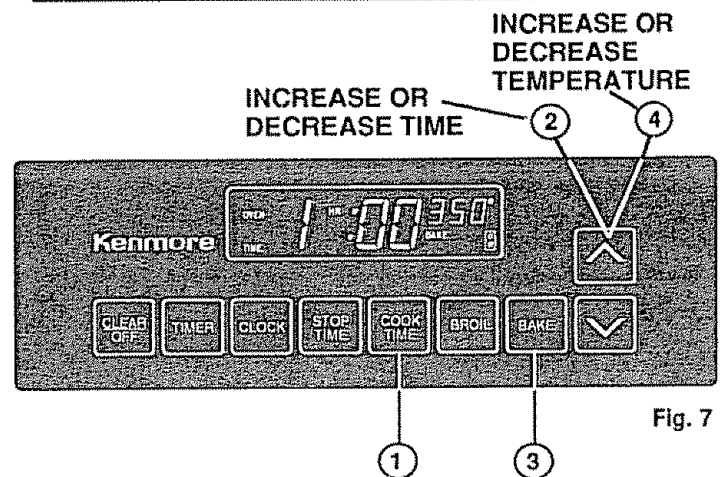
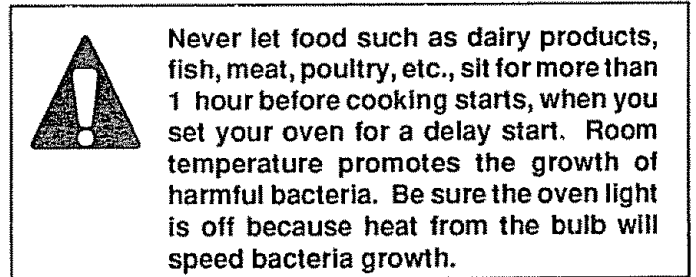
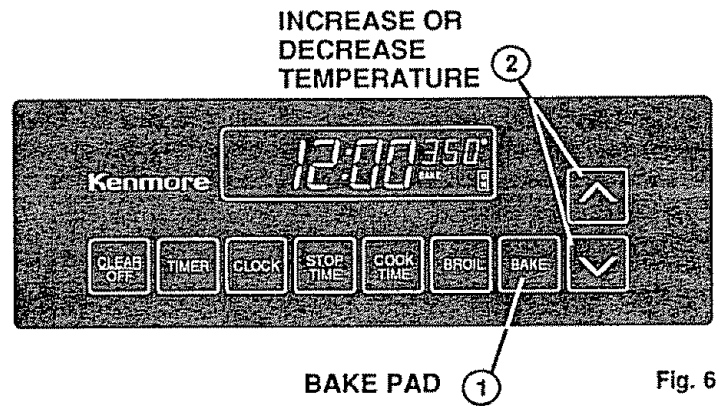

OVEN COOKING

- When cooking a food for the first time in your new oven, use time given on recipes as a guide. Your new oven has been set correctly at the factory and is apt to be more accurate than the oven it replaced.
- After you have used your oven for a while, if you feel your oven should be hotter or cooler, you can adjust it yourself. See Thermostat Adjustments in this manual.
- Always follow recipe carefully.
- Measure ingredients properly.
- Use proper pan placement. Place longest side of pan parallel to longest side of oven.
- **Place pans on the oven racks with 1" - 1 1/2" of air space on all sides of each pan. Avoid overcrowding the oven.**
- Pans too close to each other, to oven walls or to the oven bottom, block the free movement of air. Improper air movement causes uneven browning and cooking.



2 cake layers

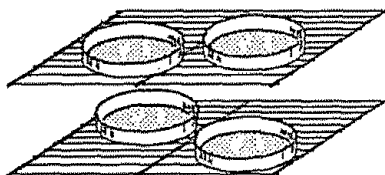

4 cake layers

- When baking several items stagger pans so that no pan is directly above another.
- Always press CLEAR/OFF before removing food.
- During baking, avoid frequent door openings. Keep oven door open as short a time as possible.
- Let the oven preheat thoroughly before cooking baked products. Allow 15 minutes preheat time, listen for the preheat notification tone, and put the food in the oven promptly.
- Avoid opening the door too often to check the food during baking as heat will be lost. This may cause poor baking results.

- Cakes, cookies, muffins, and quick breads should be baked in shiny pans — to reflect the heat — because they should have a light golden crust. Yeast breads and pie crusts should be baked in glass or dull (non-shiny) pans — to absorb the heat — because they should have a brown, crisp crust.
- Be sure the underside of the pan is shiny too. Darkened undersides will absorb the heat and may cause over-browning on the bottom of your food.

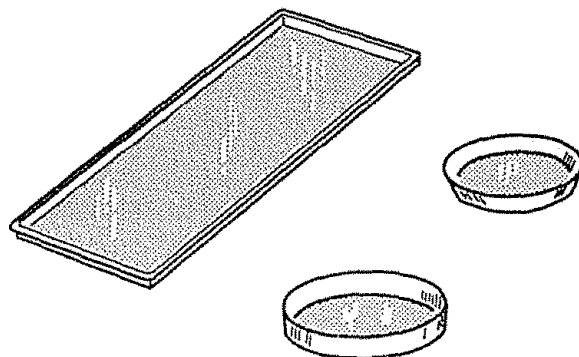

- Oven temperatures should be reduced 25 degrees below recommended temperatures if exterior of pan is predarkened, darkened by age or oven proof glass.
- There may be some odor when the oven is first used. This is caused by the heating of new parts and insulation.
- Do not cover an entire oven rack with foil. The foil can block normal heat flow and cause poor baking results. Do not place any foil directly above the bake element. Foil used on the oven bottom under the element may damage the oven surface; therefore, it should not be used.
- Cookies should be baked on flat cookie sheets without sides to allow the air to circulate properly. We recommend 10" x 14" cookie sheets for best results.
- When recipes require preheating, have food nearby before you open the oven door. If the oven door is allowed to remain open for more than a brief time, the preheat temperature will be lost.
- Use residual heat in oven whenever possible to finish cooking casseroles, oven meals, etc. Use residual heat when baking rolls or precooked desserts.

BROILING

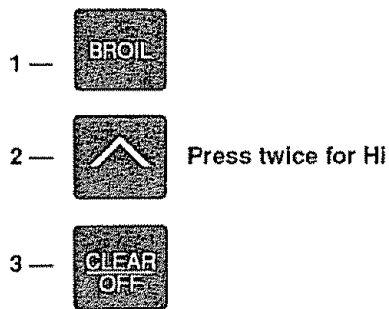

Most foods can be broiled at the HI Broil Setting. Select the LO Broil setting to avoid excessive browning or drying of foods that should be cooked to the well-done stage (such as thick pork chops or poultry).

BROILING TIPS

- Your oven door should be open to the broil stop position while broiling. If the door is closed, the food will roast and not broil.
- Use only the broiler pan and grid that came with your oven for broiling. They are designed for proper drainage of fat and liquids and help prevent spatter, smoke or fire.
- **Do not preheat when broiling.** For even broiling on both sides, start the food on a cold pan.
- Trim the outer layer of fat from steaks and chops. Slit the fatty edges to keep the meat from curling.
- For maximum juiciness, salt the first side just before turning the meat. Salt the second side just before serving.
- Brush chicken and fish with butter several times as they broil. When broiling fish, grease the grid to prevent sticking and broil with skin side down. It is not necessary to turn fish.
- **Never leave a soiled broiler pan in the range.** Grease in the pan may smoke or burn the next time the oven is used.
- **Be sure you know the correct procedure for putting out a grease fire. See the section on safety.**

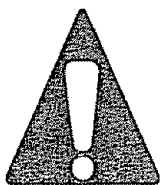

Do not cover the entire broiler grid with foil. Poor drainage of hot fat may cause a broiler fire.

If a fire starts, close the oven door and turn controls off. If fire continues, throw baking soda on the fire. Do not put water on the fire.

POSITIONING BROILER PAN

Broiling is cooking by direct heat from the broil element. Tender cuts of meat or marinated meat should be selected for broiling. For best results steaks and chops should be at least 3/4" thick.

After placing food on the broiler pan, put the pan on an oven rack in the proper position. The recommended rack position and cooking time can be found in the chart below.

The closer the food is to the broil element, the faster the meat browns on the outside, yet stays red to pink in the center. Moving the meat farther away from the element lets the meat cook to the center while browning outside. Side one should be cooked 1 - 2 minutes longer than side two.

Food	Rack Position 4 = Highest 1 = Lowest	Total Time (minutes)
Steak – 1" Thick		
Rare	4	9-11
Medium	3	13-15
Well Done	3	21-23
Ground Beef Patties		
Medium-1" Thick	3	16-18
Medium-1/2" Thick	4	7-9
Lamb Chops –1" Thick	3	18-21
Pork Chops – 1" Thick	3	27-29
Pork Chops 1/2" Thick	3	16-18
Ham Slice – 1/2" Thick	3	11-12
Fish (Fillets)	3	11-13
Chicken (Pieces)	2	45-55
Frankfurters	3	8-11
Bacon	3	9-11

This chart is a general guide. The size, weight, thickness, and starting temperature of the food, as well as your own personal preference, will affect the cooking time. Times in the chart are based on the food being at refrigerator temperature.

CLEANING TIPS

Refer to the removable parts section when cleaning your oven.

Warm water, a mild detergent and a soft cloth are safe to use on all cleanable parts of your oven.

Do not use metal scouring pads, except where recommended.

REMOVAL OF PACKAGING TAPE: The safest way to remove adhesive left from packing tape on new appliances to assure no damage is done to the finish of the product is an application of household liquid dishwashing detergent, mineral oil, or cooking oil. Apply with soft cloth and allow to soak. Wipe with soft cloth. **DO NOT** use plastic pad or equivalent. Wipe dry and then apply an appliance polish to thoroughly clean and protect the surface. This procedure is also safe for the face of microwave doors and other plastic and lexan parts.

NOTE: The plastic tape that is not removed from chrome trim on range parts **CANNOT** be removed if baked on.

PART	CLEANING MATERIALS	REMARKS
Control panel	Soap and water, damp cloth, paper towel	Wipe with a damp cloth to remove soil. Do not wipe when oven is in use. DO NOT USE abrasive cleaning powders, steel wool or plastic balls. They will mar the surface.
Standard oven interior (CAUTION: When in use, light bulbs can become warm enough to break if touched with a moist cloth or towel. When cleaning, avoid touching warm lamps with cleaning cloths if lamp cover is removed.)	Cleansing powder, steel wool pad	Cool before cleaning. FOR LIGHT SOIL: Frequent wiping with mild soap and water (especially after cooking meat) will prolong the time between major cleaning. Rinse thoroughly.
	NOTE: Soap left on the liner causes additional stains when oven is reheated. FOR HEAVY SOIL: Choose an oven cleaner and follow label instructions. Use of rubber gloves is recommended. Wipe off any cleaner that gets on the thermostat bulb. When rinsing oven after cleaning, also wipe thermostat bulb.	
Oven rack	Detergent, warm water, scouring pad or soap-filled steel wool pad or oven cleaner	Remove from oven to clean. Rinse thoroughly. Racks are dishwasher safe.
Broiler pan and grid	Detergent, warm water, soap-filled scouring pad, commercial oven cleaner (pan only)	Remove soiled pan from oven to cool. Drain fat or drippings. Fill pan with warm water. Sprinkle grid with detergent and cover with damp cloth or paper towels. Let pan and grid soak for a few minutes. Rinse or scour as needed. Grid and pan may be washed in a dishwasher.
Glass	Glass cleaner and paper towels If you need additional cleaning for spotting, wash with equal parts white vinegar and warm water. Rinse well and dry. Door should be completely open when cleaning the top edge.	Do not allow water to run down inside opening in door while cleaning. Remove stubborn soil with paste of baking soda and water. Do not use abrasive cleaners. Rinse thoroughly. Door can be removed; see removable parts section.
Porcelain enamel and painted surfaces	Detergent, warm water, paper towel, dry cloth	If acidic foods (such as tomatoes or lemon juice) should spill on the oven while it is hot, use a dry paper towel or cloth to wipe them up right away.
	When the surface has cooled, wash and rinse. Polish with dry cloth. No matter how stubborn the stain, never use harsh abrasive cleaners. They could permanently damage the enamel surface. We recommend a cleanser such as Soft Scrub® brand or a similar cleaning product to keep porcelain surfaces looking clean and new. After cleaning, rinse well with a vinegar and water mixture. This will help prevent a brown residue from forming when the oven is heated. Buff these areas dry with a dry cloth.	
Bake element and broil element	Do not clean	Any soil will burn off when the unit is heated. NOTE: The bake element can be lifted gently to clean the oven floor. If spillover, residue or ash accumulates around the bake element, gently wipe the cooled element with warm water.

REMOVABLE OVEN DOOR

To remove:

1. Open the door to the stop position (see illustration).
2. Grasp the door at each side and lift up and off the hinges.

NOTE: When the door is removed and hinge arms are at stop position, do not bump or try to move the hinge arms. The hinges could snap back causing an injury to the hands or damage to the porcelain on the front of the range. Cover the hinges with toweling or empty towel rolls while working in the oven area.

To replace:

1. Hold the door over the hinges with the slots at the bottom edge of the door lined up with the hinges. The hinge arms must still be in the stop position.

2. Slide the door down onto the hinges as far as it will go and close the door.

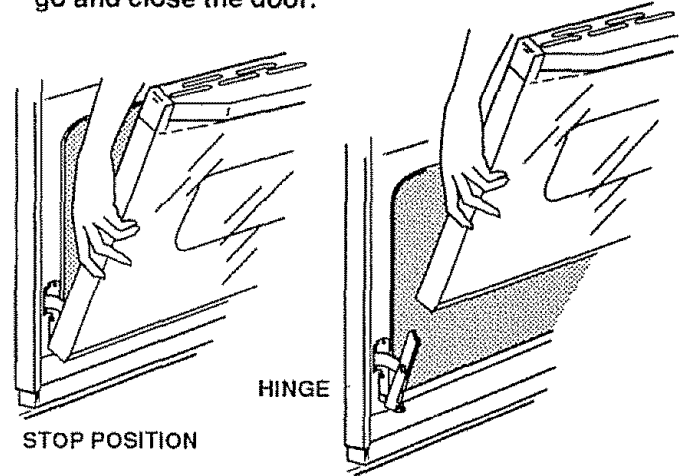

NOTE: Do not allow water to run down inside the door. Open door completely when cleaning the top edge.

REMOVABLE OVEN RACKS

Be careful not to scratch the oven finish when installing or removing oven racks.

To install:

1. Set the raised back edge of the rack on a pair of rack guides.
2. Push the rack in until you reach the bump in the rack guide, then lift the front of the rack a bit and push the rack all the way in.

To remove:

1. Pull the oven rack out, then up, in one motion. See the cleaning chart.

NOTE: The racks are designed with stop locks. When placed correctly on the rack support and extended from the oven, the stop lock prevents the racks from tilting when you are removing food from the racks or placing food on them.

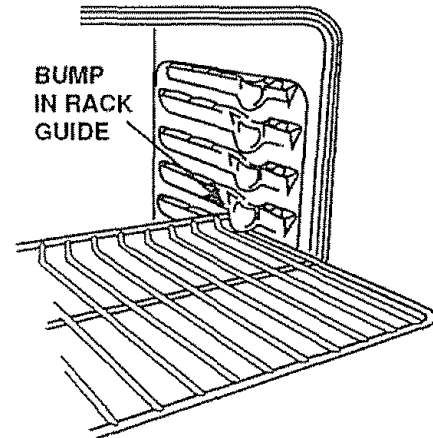

REPLACING OVEN LIGHT



Do not touch hot oven bulb. Do not touch bulb with wet hands. Never wipe oven light area with wet cloth.



Never touch the electrically live metal collar on the bulb when replacing.

To remove:

1. Disconnect electric power to the oven at the main fuse or circuit breaker.
2. Hold your hand under cover and firmly push back the bail wire until it clears the cover. The cover will fall into your hand. **DO NOT REMOVE ANY SCREWS TO REMOVE THE COVER.**
3. Replace bulb with 40-watt home appliance bulb.

To replace cover:

1. Place cover into groove of lamp receptacle. Pull wire bail forward until it snaps into place. Be certain wire bail is in center of cover. Wire will hold cover firmly when in correct position.
2. Connect power to oven.

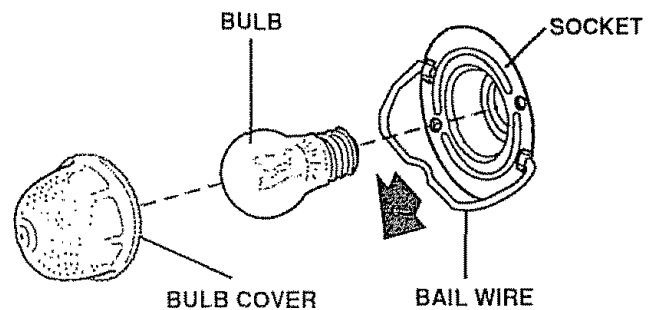

BEFORE CALLING FOR SERVICE

Save time and money — Check this list before you call for service.

To eliminate unnecessary service calls, first, read all the instructions in this manual carefully. Then, if you have a problem, always check this list of common problems and possible solutions before you call for service.

If you do have a problem you cannot fix yourself, call your nearest Sears Store or Service Center for help. When calling, have your manual and repair parts list handy with the model number, serial number and purchase date of your oven.

PROBLEM	POSSIBLE CAUSE	DON'T CALL FOR SERVICE UNTIL YOU CHECK
<ul style="list-style-type: none"> Oven display is flashes "F" and a number; oven stops working 	<ul style="list-style-type: none"> Possible oven malfunction 	<ul style="list-style-type: none"> Press CLEAR/OFF. Let oven cool down for 1 hour. Place oven back into operation. If problem repeats, call for service.
<ul style="list-style-type: none"> Oven does not work; totally inoperative 	<ul style="list-style-type: none"> No power to oven 	<ul style="list-style-type: none"> Check household circuit breaker or fuse.
<ul style="list-style-type: none"> Oven does not heat; clock okay 	<ul style="list-style-type: none"> Oven controls set incorrectly Clock set incorrectly 	<ul style="list-style-type: none"> Check oven control instructions. Clock must have correct time of day to set Timed Operations for specific time of day.
<ul style="list-style-type: none"> Foods do not bake properly 	<ul style="list-style-type: none"> Oven not preheated long enough Improper rack or pan placement Improper use of foil Improper temperature setting for utensil used Recipe not followed Oven rack not level Using improper cookware 	<ul style="list-style-type: none"> Be sure to pre-heat: until preheat tone sounds or 15 mins. Maintain uniform air space (1" to 1 1/2") around pans and utensils; see cooking hints section. Do not line oven bottom with foil. Do not cover an entire rack with foil. Reduce temperature 25 degrees for glass or dull/darkened pans. Is recipe tested and reliable? Check the installation section for leveling instructions. See oven cooking section.
<ul style="list-style-type: none"> Oven temperature seems inaccurate 	<ul style="list-style-type: none"> Oven calibration Is recipe tested and reliable? 	<ul style="list-style-type: none"> See Thermostat Adjustments.
<ul style="list-style-type: none"> Foods do not broil properly 	<ul style="list-style-type: none"> Improper rack position Oven preheated Improper utensil used Oven door closed during broil Improper broiling time 	<ul style="list-style-type: none"> Check broil pan placement. See broiling section. Do not preheat when broiling. Use broiler pan and grid supplied with range. Open door to broil stop position; see removable oven door section. Check broiling chart in broiling section.
<ul style="list-style-type: none"> Oven smokes 	<ul style="list-style-type: none"> Dirty oven Broiler pan containing grease left in oven 	<ul style="list-style-type: none"> Wipe up heavy spillovers on the oven bottom. Clean pan and grid after each use.
<ul style="list-style-type: none"> Oven light does not work 	<ul style="list-style-type: none"> Light switch in off position Light bulb burned out 	<ul style="list-style-type: none"> Check switch setting. Check or replace light bulb; see removable parts section.
<ul style="list-style-type: none"> Tone does not sound 	<ul style="list-style-type: none"> Tone has been eliminated 	<ul style="list-style-type: none"> Push and hold CLEAR/OFF to activate tone.

TO REMOVE MELTED PLASTIC/ FOIL FROM ELEMENTS. . .

For removal of melted plastic/foil on surface units, bake elements or racks:

- A. Turn range vent hood on.
- B. Turn surface or bake element on and allow to warm up. When the plastic/foil softens, scrape off as much as possible using a blunt metal instrument such as a metal spatula.
- C. Turn the unit on high and let the rest of the plastic/foil burn off.

NOTE: The same procedure may be used for solid disc elements.

THERMOSTAT ADJUSTMENTS

The temperature in your new oven has been set correctly at the factory, so be sure to follow the recipe temperatures and cooking times the first few times you bake in your oven.

If you think the oven should be hotter or cooler, you can adjust the oven temperature yourself. To decide how much to change the temperature, set the oven temperature 25°F higher or lower than the temperature in your recipe, then bake. The results of this "test" should give you an idea of how much the temperature should be changed.

To adjust temperature follow these instructions:

1. Push **BAKE**.
2. Select a temperature between 500°F and 550°F by pressing up. See Fig. 1.

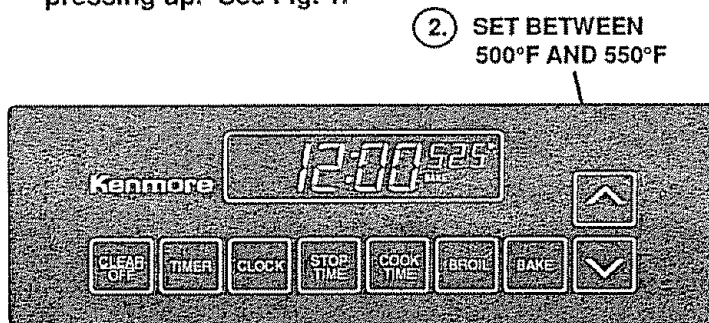

Fig. 1

3. IMMEDIATELY, press **BAKE** again and hold for about 4 seconds. This display will show "ON" and "BAKE" will flash in the display. See Fig. 2.

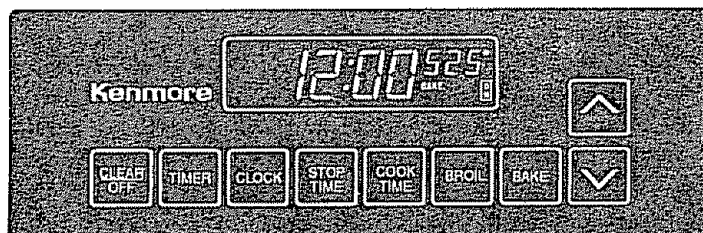

Fig. 2

3. IMMEDIATELY, PRESS

Continue to hold **BAKE** until the display changes to show the preset oven temperature adjustment. See Fig. 3.

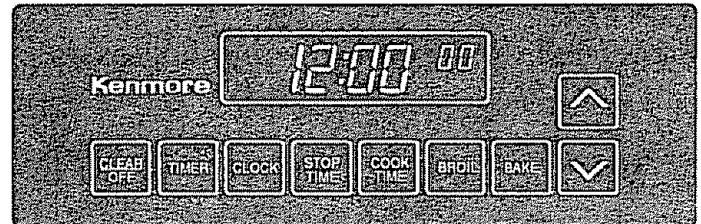

Fig. 3

4. The temperature can be adjusted up to +35°F hotter or -35°F cooler. Use up or down to select the temperature adjustment you want. See Fig. 4. The temperature you select is the new preset temperature adjustment.

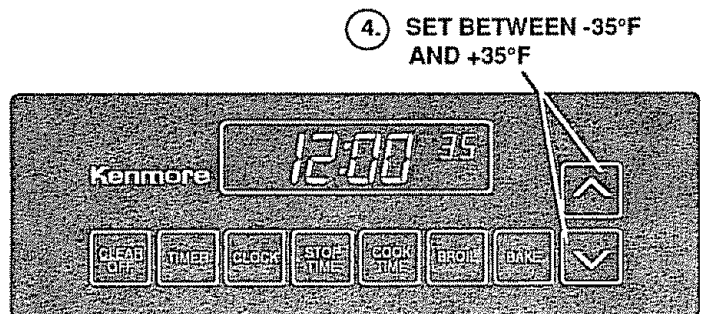

Fig. 4

5. When you have made the adjustment, push **CLOCK** to return the display to the time of day. Use your oven as you would normally.

The adjustment you have made to the oven temperature will be remembered by the control and will automatically adjust the oven temperature by that amount each time you set a bake temperature.

NOTE: This adjustment will not affect Broil temperatures. It will be remembered when power is removed.

We do not recommend the use of inexpensive thermometers, such as those found in grocery stores, to readjust the temperature setting of your new oven. These thermometers can vary by 20°-40°. Your oven has been preset to maximize cooking efficiency. To obtain peak cooking results, make the temperature adjustment and re-evaluate your cooking results for several days. If still not satisfied, readjust the thermostat.

NOTES

KENMORE ELECTRIC OVEN WARRANTY

Dear Customer:

Our constant efforts are directed toward making sure your new Kenmore Oven will arrive at your home in perfect condition and will give you proper performance. As part of these efforts, we feel it is our responsibility to provide you with this warranty for your range.



FULL ONE YEAR WARRANTY ON THE FUNCTIONING OF ALL PARTS EXCEPT GLASS PARTS

If, within one year from the date of installation, any part, other than a glass part, falls to function properly due to a defect in material or workmanship, Sears will repair or replace it, free of charge.

FULL 30-DAY WARRANTY ON GLASS PARTS AND FINISH OF PORCELAIN ENAMEL, PAINTED OR BRIGHT METAL FINISHED PARTS

If, within 30 days from the date of installation, any glass part or the finish on any porcelain enamel, painted or bright metal part is defective in material or workmanship, Sears will replace the part, free of charge.

FULL 90-DAY WARRANTY ON MECHANICAL ADJUSTMENTS

For 90 days from the date of installation, Sears will provide, free of charge, any mechanical adjustments necessary for proper operation of the range, except for normal maintenance.

If the range is subjected to other than private family use, the above warranty coverage is effective for only 90 days.

WARRANTY SERVICE IS AVAILABLE BY CONTACTING THE NEAREST SEARS SERVICE CENTER/DEPARTMENT IN THE UNITED STATES

This warranty applies only while this product is in use in the United States. This warranty gives you specific legal rights, and you may also have other rights which vary from state to state.

SEARS, ROEBUCK and CO.
Dept. 731 CR-W
Sears Tower
Chicago, IL 60684

WE SERVICE WHAT WE SELL

"We Service What We Sell" is our assurance to you that you can depend on Sears for service because Sears service is nationwide.

Your Kenmore Oven has added value when you consider that Sears has a service unit near you staffed by Sears trained technicians. . . professional technicians specifically trained on Sears appliances, having the parts, tools and equipment to ensure that we meet our pledge to you — "We Service What We Sell!"

TO FURTHER ADD TO THE VALUE OF YOUR RANGE, BUY A SEARS MAINTENANCE AGREEMENT.

Kenmore Ovens are designed, manufactured and tested for years of dependable operation. Yet, any modern appliance may require service from time to time. The Sears Warranty plus the Sears Maintenance Agreement provides protection from unexpected repair bills and assures you of enjoying maximum range efficiency.

Here's a comparative warranty and Maintenance Agreement chart showing you the benefits of a Sears Range Maintenance Agreement.

Years of Ownership Coverage		1st Year	2nd Year	3rd Year
1	Replacement of Defective Parts other than Porcelain or Glass	W	MA	MA
2	Mechanical Adjustment	90 DAYS W	MA	MA
3	Porcelain and Glass Parts	30 DAYS W	MA	MA
4	Annual Preventive Maintenance Check at your request	MA	MA	MA

W - Warranty MA - Maintenance Agreement

CONTACT YOUR SEARS SALESPERSON OR LOCAL SEARS SERVICE CENTER TODAY AND PURCHASE A SEARS MAINTENANCE AGREEMENT.

Kenmore® America's Best Selling Appliance Brand

Sold by SEARS, ROEBUCK AND CO., Chicago, IL 60684

— Printed in LaFayette, Georgia —