

# **VEVOR<sup>®</sup>**

**TOUGH TOOLS, HALF PRICE**

Technical Support and E-Warranty Certificate [www.vevor.com/support](http://www.vevor.com/support)

## **GARDEN OUTDOOR CLEAR DOOM USER MANUAL**

We continue to be committed to provide you tools with competitive price. "Save Half", "Half Price" or any other similar expressions used by us only represents an estimate of savings you might benefit from buying certain tools with us compared to the major top brands and does not necessarily mean to cover all categories of tools offered by us. You are kindly reminded to verify carefully when you are placing an order with us if you are actually saving half in comparison with the top major brands.

# VEVOR<sup>®</sup>

TOUGH TOOLS, HALF PRICE

GARDEN OUTDOOR CLEAR  
DOOM

Model: GB-DOME-12, GB-DOME-12T, GB-DOME-9.5 GB-DOME-9.5T

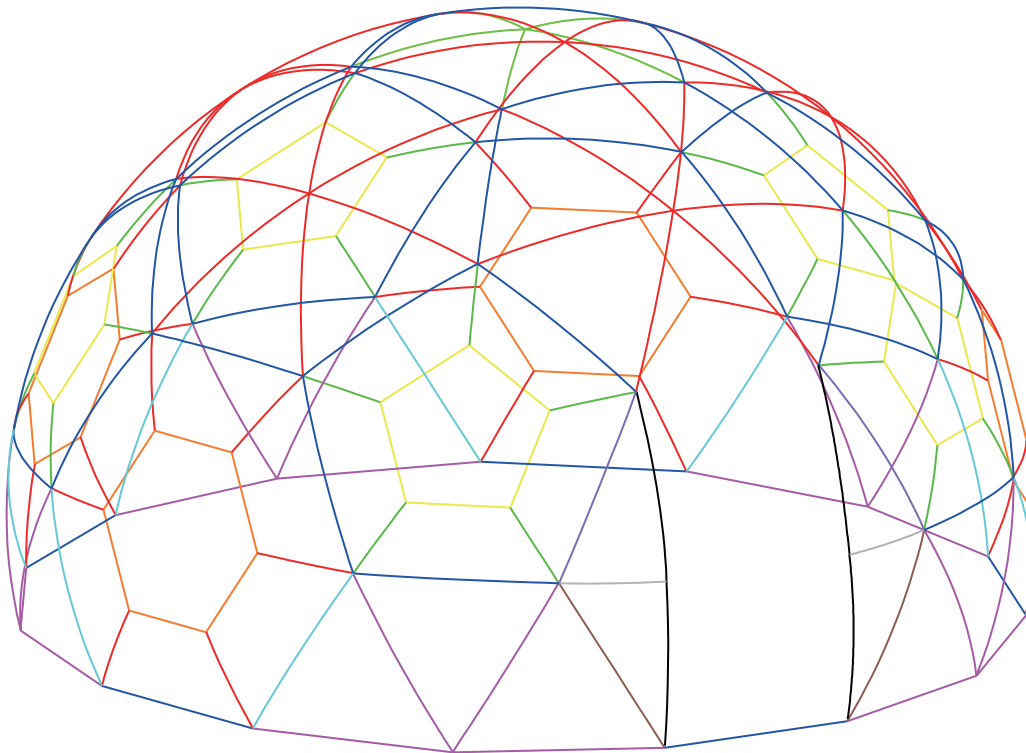

## NEED HELP? CONTACT US!

Have product questions? Need technical support? Please feel free to contact us:  
Technical Support and E-Warranty Certificate [www.vevor.com/support](http://www.vevor.com/support)

This is the original instruction, please read all manual instructions carefully before operating. VEVOR reserves a clear interpretation of our user manual. The appearance of the product shall be subject to the product you received. Please forgive us that we won't inform you again if there are any technology or software updates on our product.

# SPECIFICATIONS

Model	GB-DOME-12
Product Size	12ft
Color	Transparent
Load Capacity	110lb

Model	GB-DOME-12T
Product Size	12ft
Color	Transparent
Load Capacity	110lb

Model	GB-DOME-9.5
Product Size	9.5ft
Color	Transparent
Load Capacity	110lb

Model	GB-DOME-9.5T
Product Size	9.5ft
Color	Transparent
Load Capacity	110lb







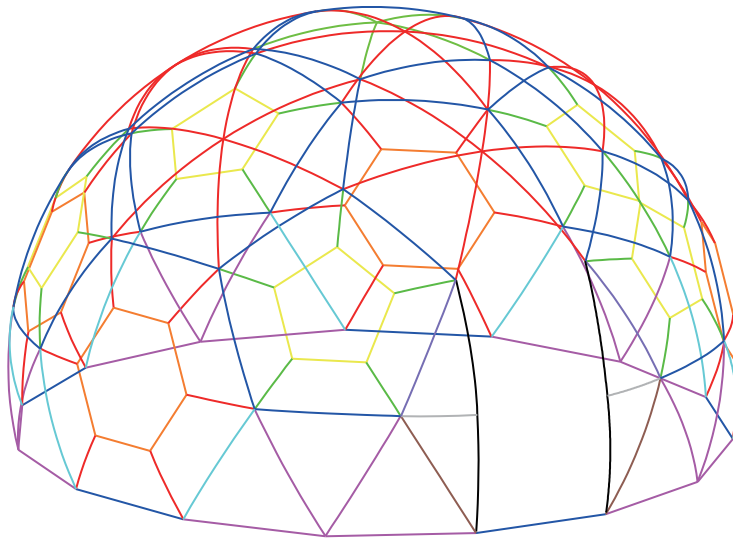

# Accessories

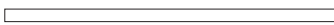
Model	PVC Transparent Cover	Mosquito Cover
GB-DOME-12	✓	×
GB-DOME-12T	✓	✓
GB-DOME-9.5	✓	×
GB-DOME-9.5T	✓	✓

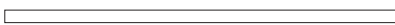

Pipes :

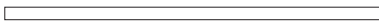
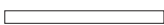
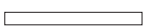
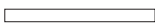
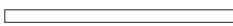
- A  5pcs
- B  42pcs
- C  50pcs
- D  4pcs
- E  8pcs
- G  2pcs
- H  2pcs
- I  2pcs
- J  25pcs
- K  25pcs
- L  24pcs
- M  24pcs

Cover:

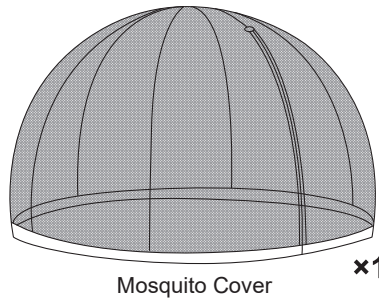
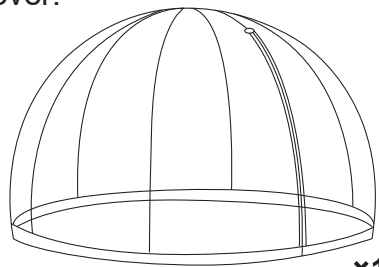

Standard Assesories:

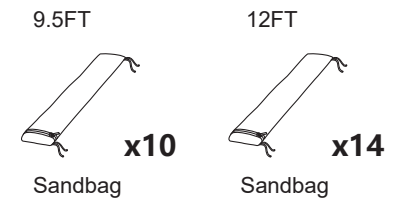
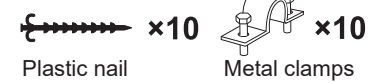

Connectors:

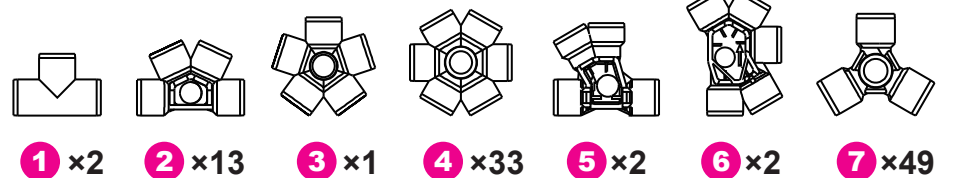

# Step-01

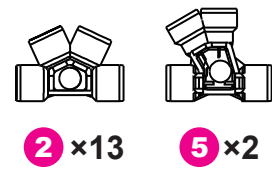
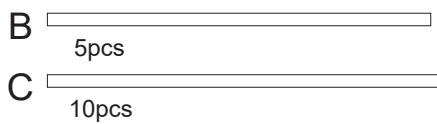
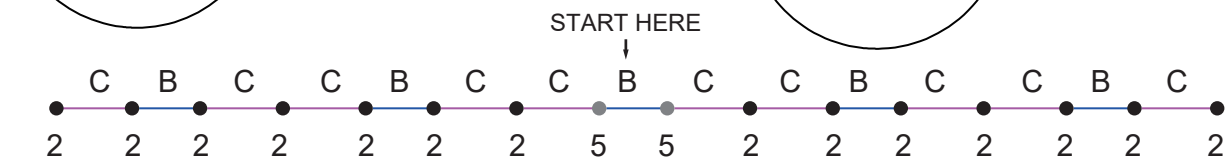
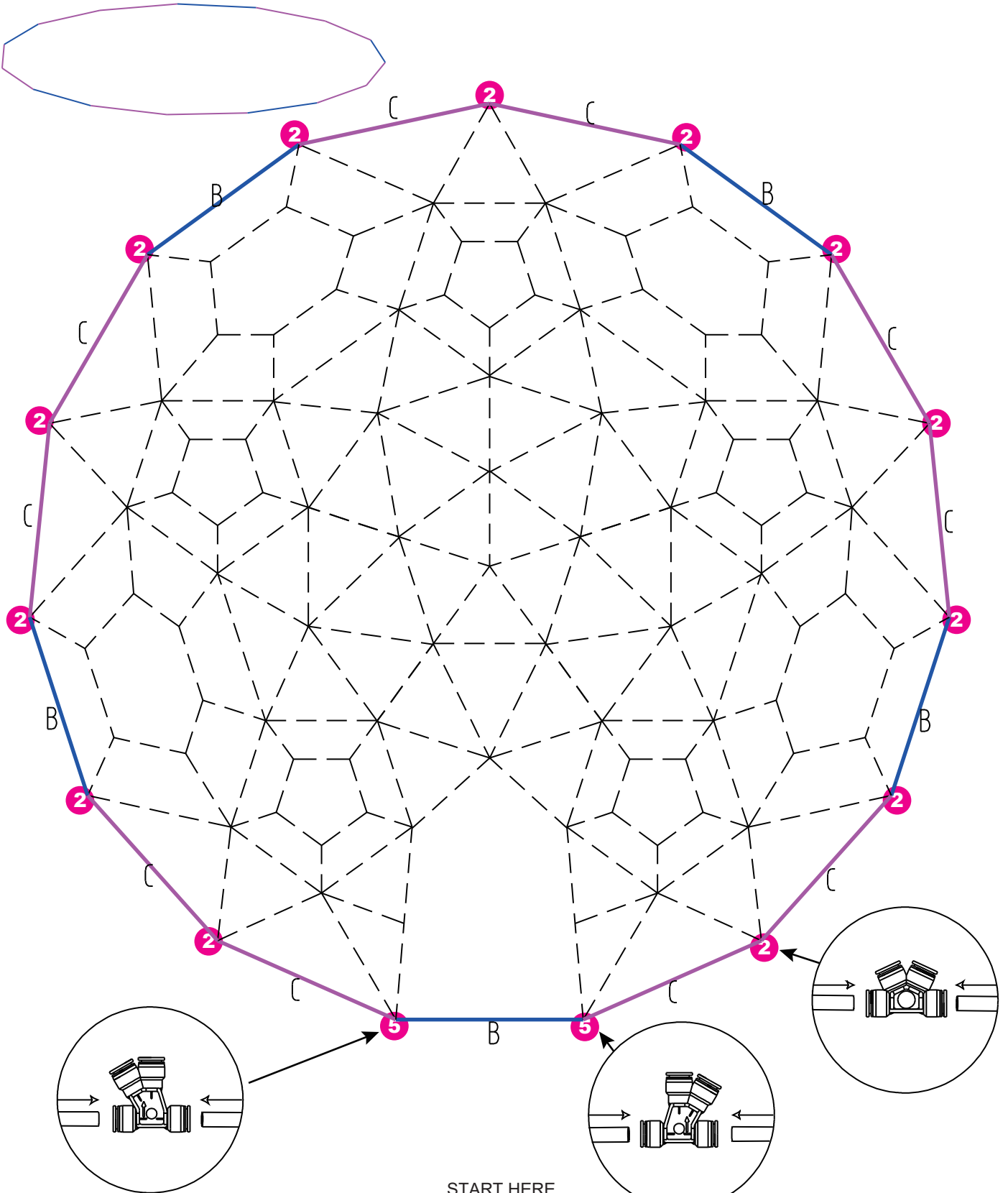

# Step-02

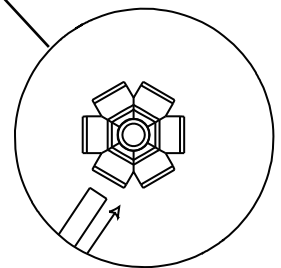
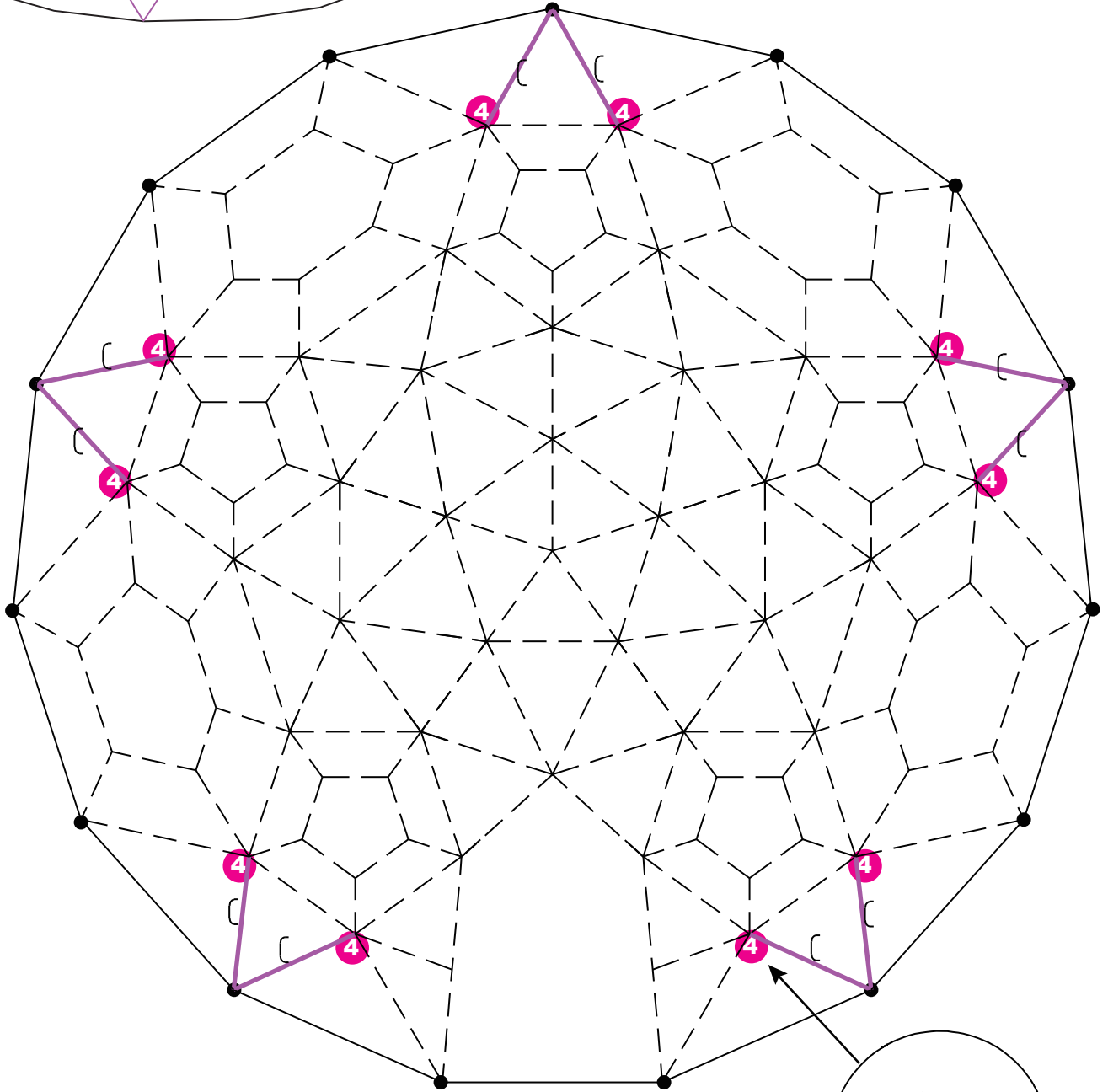
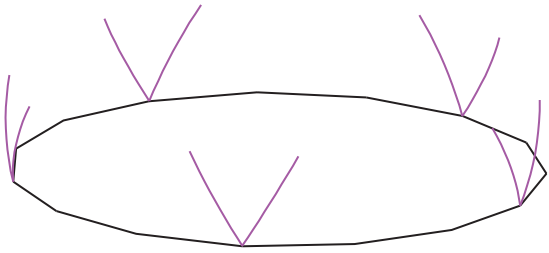

C  10pcs

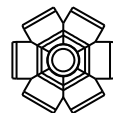

4 x 10

# Step-03

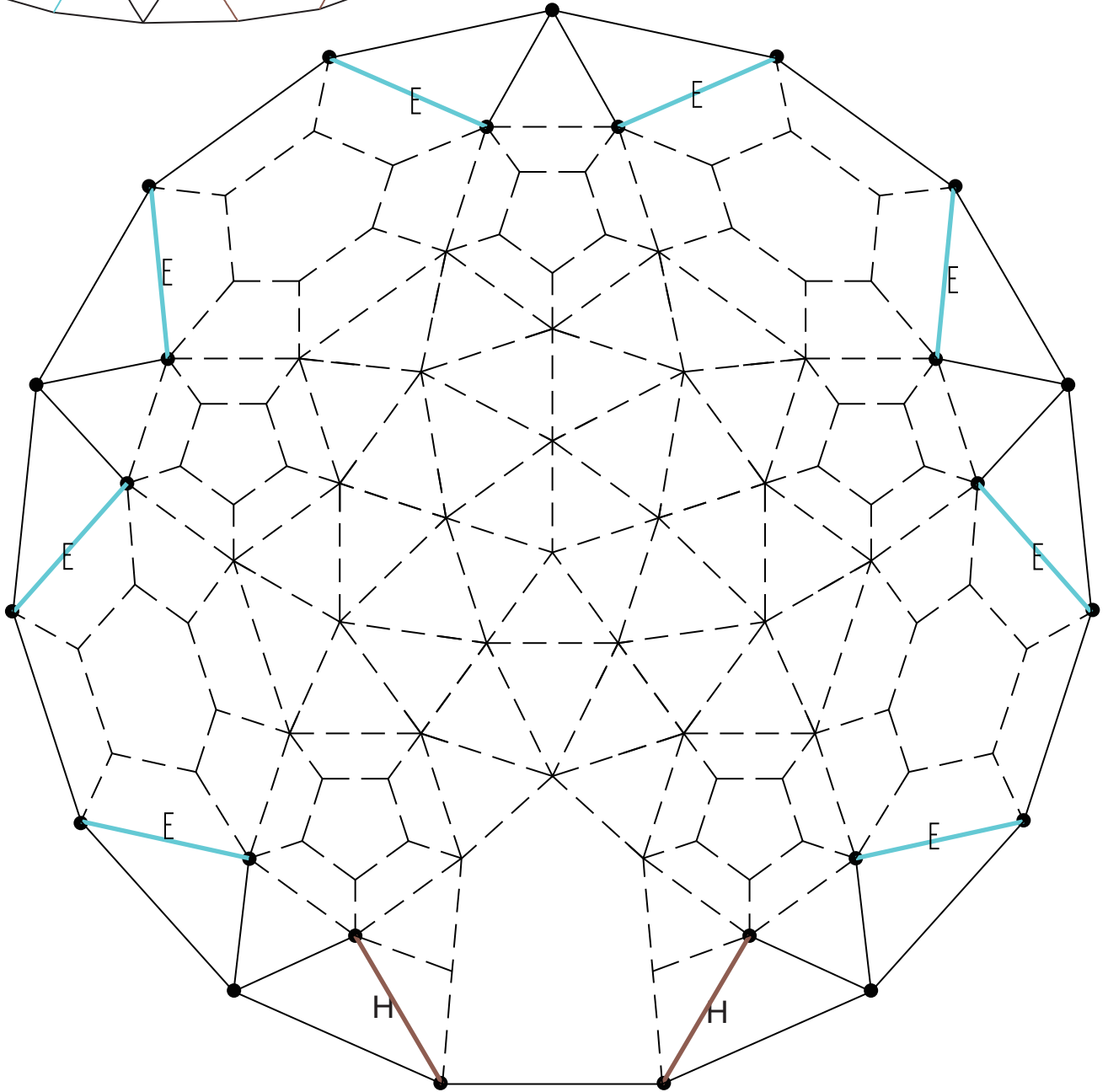
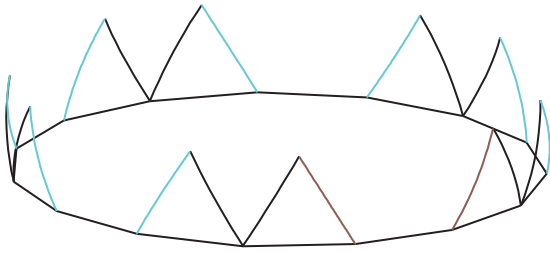



E  8pcs

H  2pcs

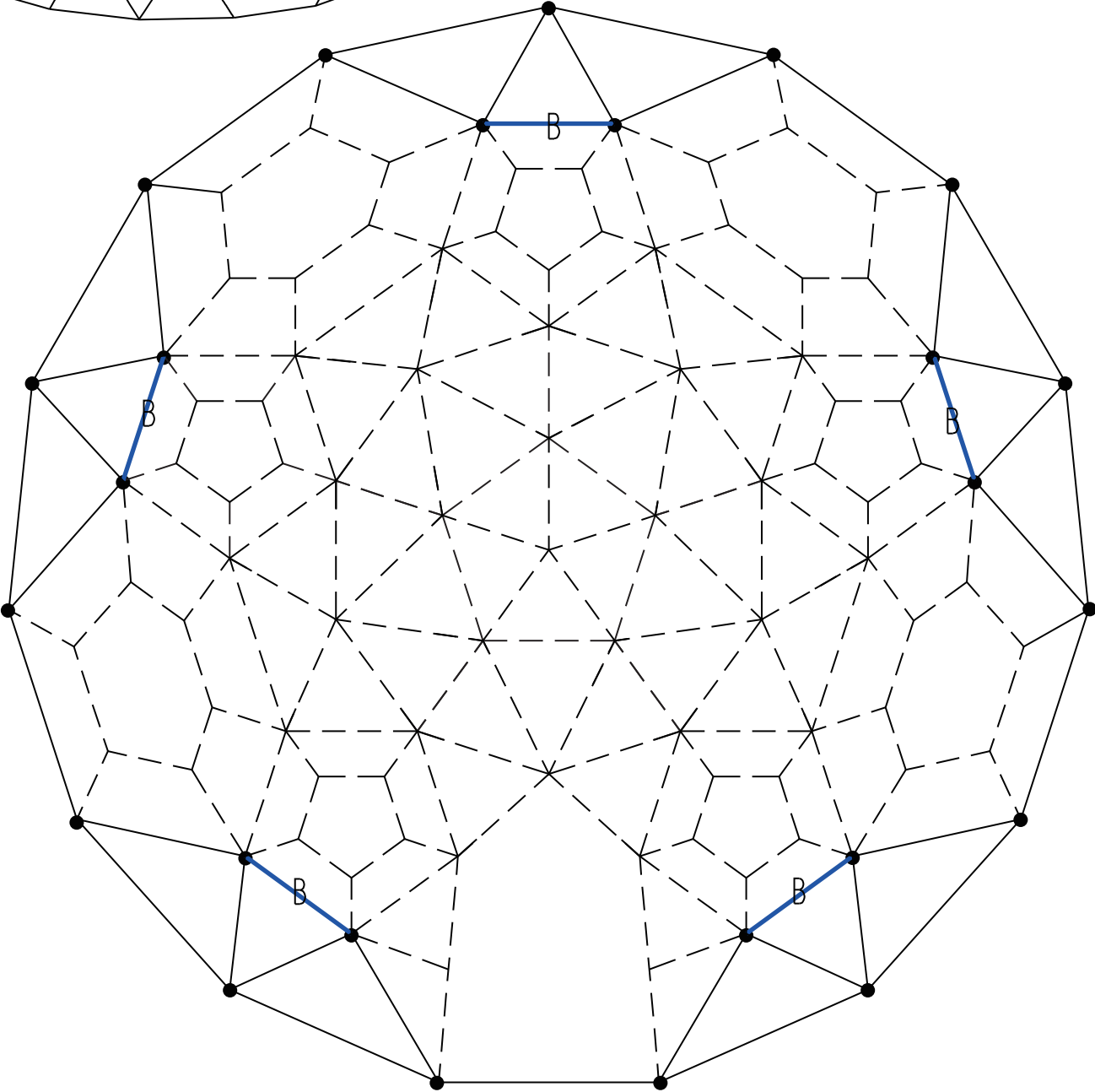
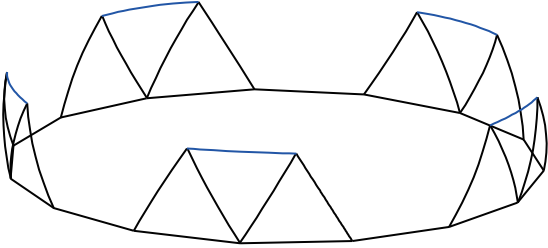

# Step-04



B  5pcs



# Step-05

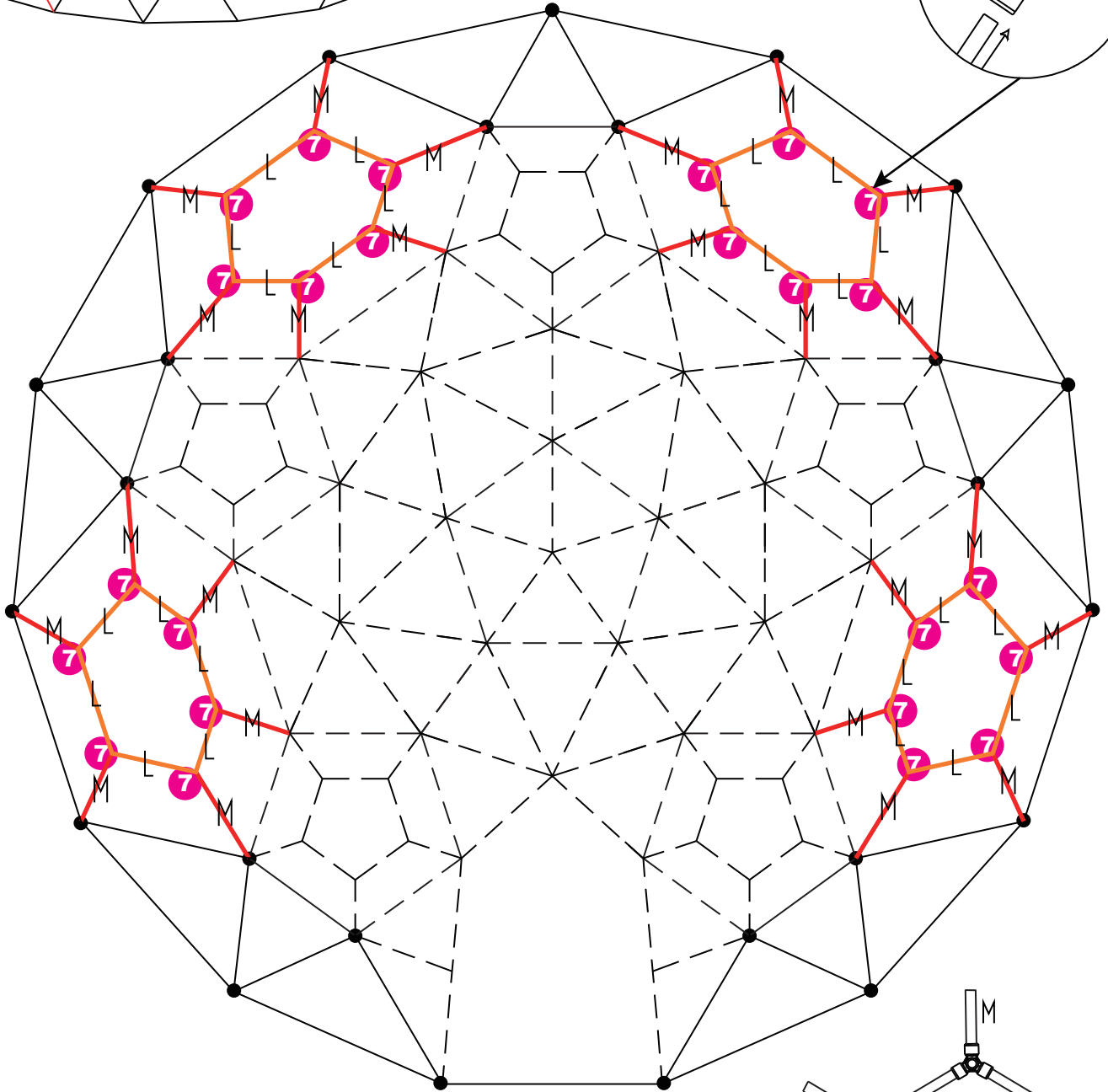
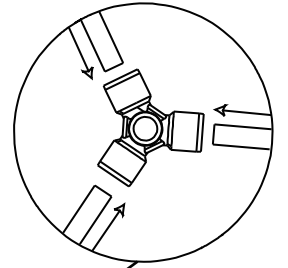
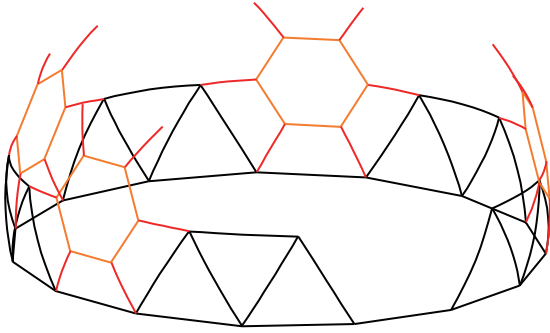

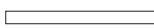
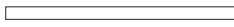
L  24pcs  
 M  24pcs

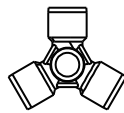

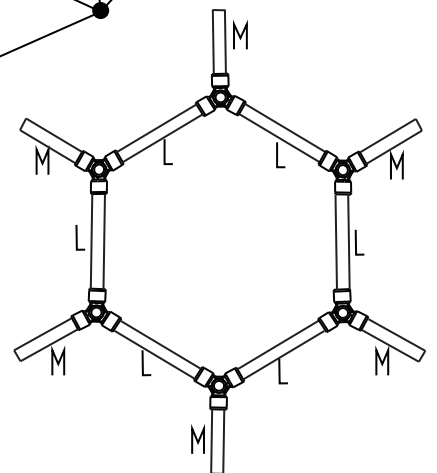

**7** × 24

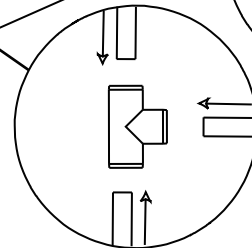
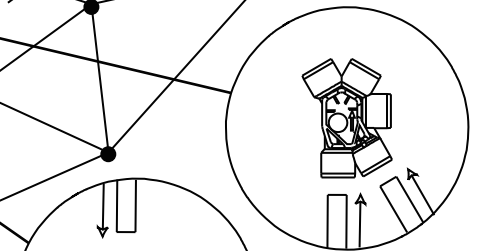
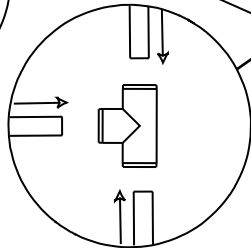
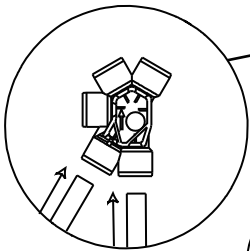
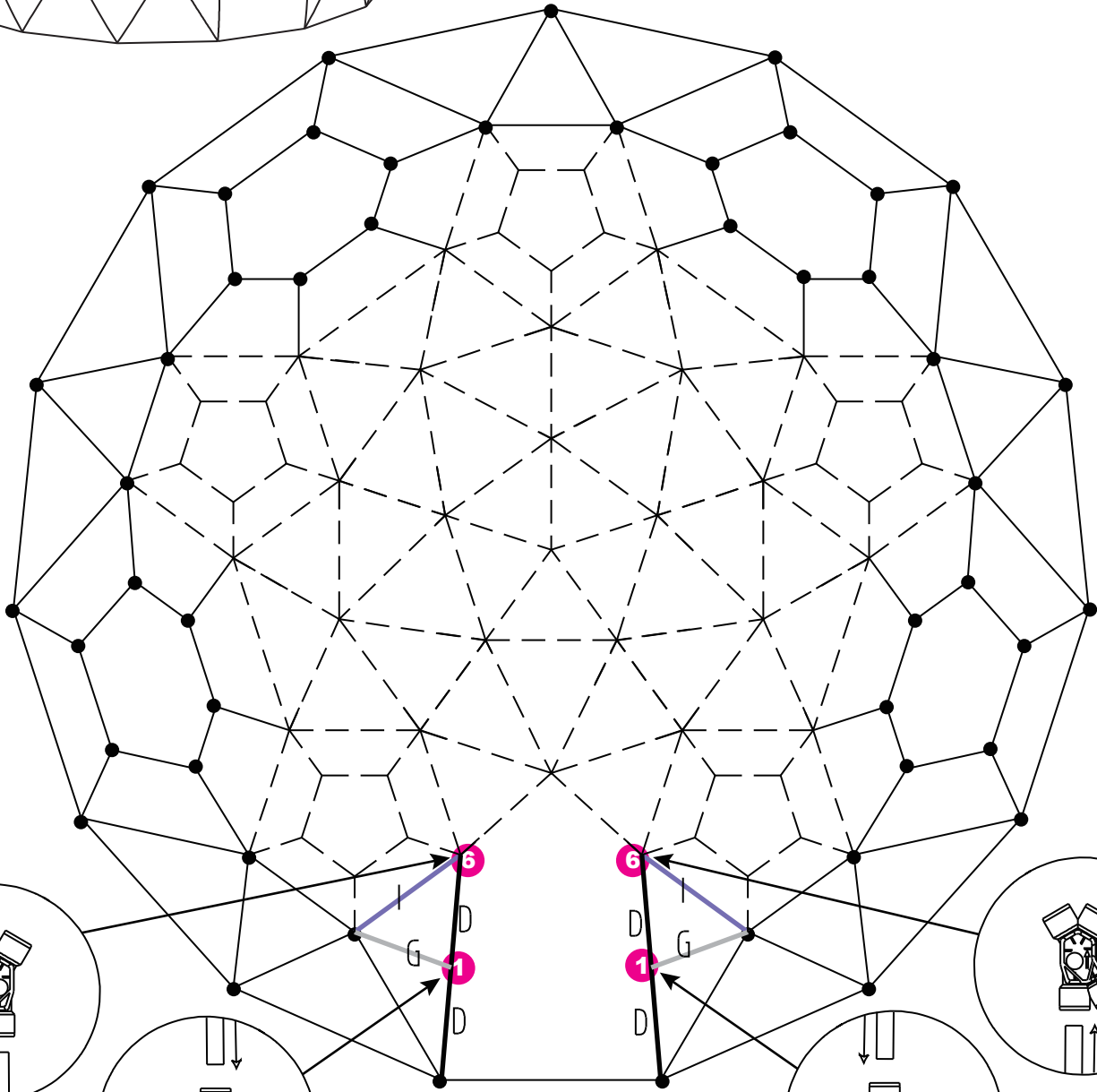
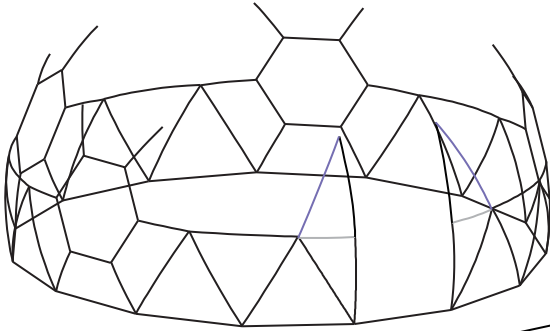

# Step-06

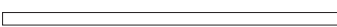

D  4pcs

G  2pcs

I  2pcs

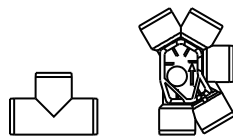

**1** x2

**6** x2

# Step-07

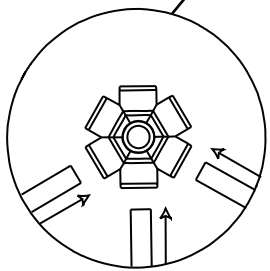
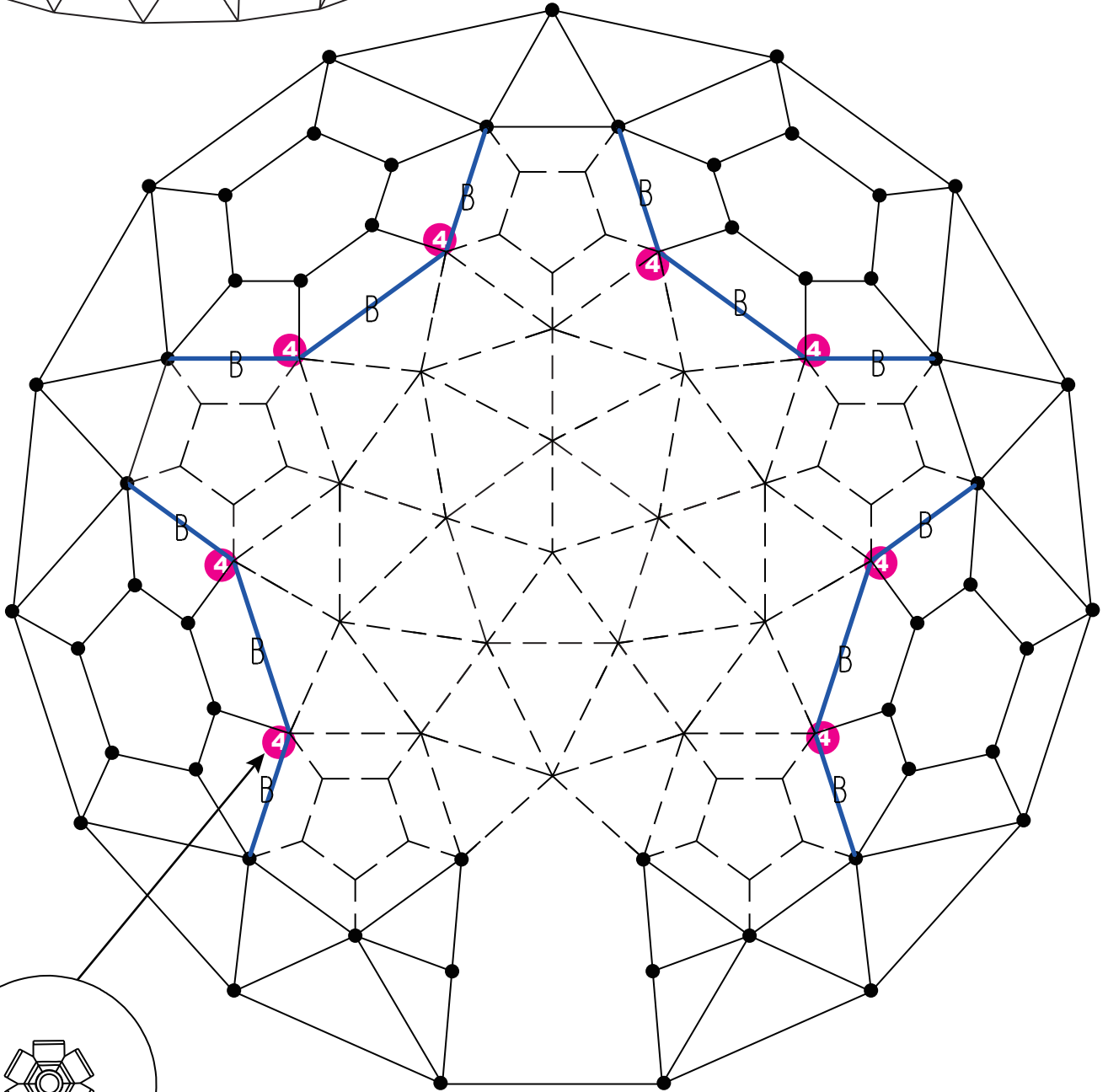
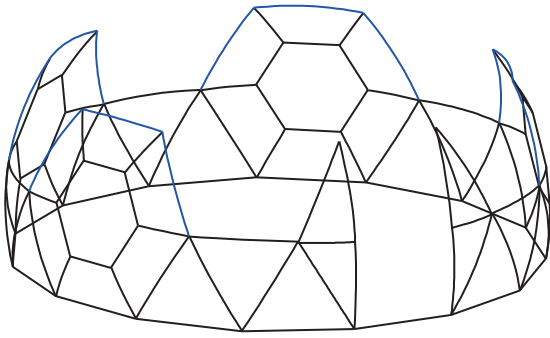

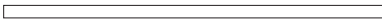
B  12pcs

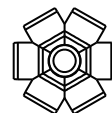

4 x 8

# Step-08

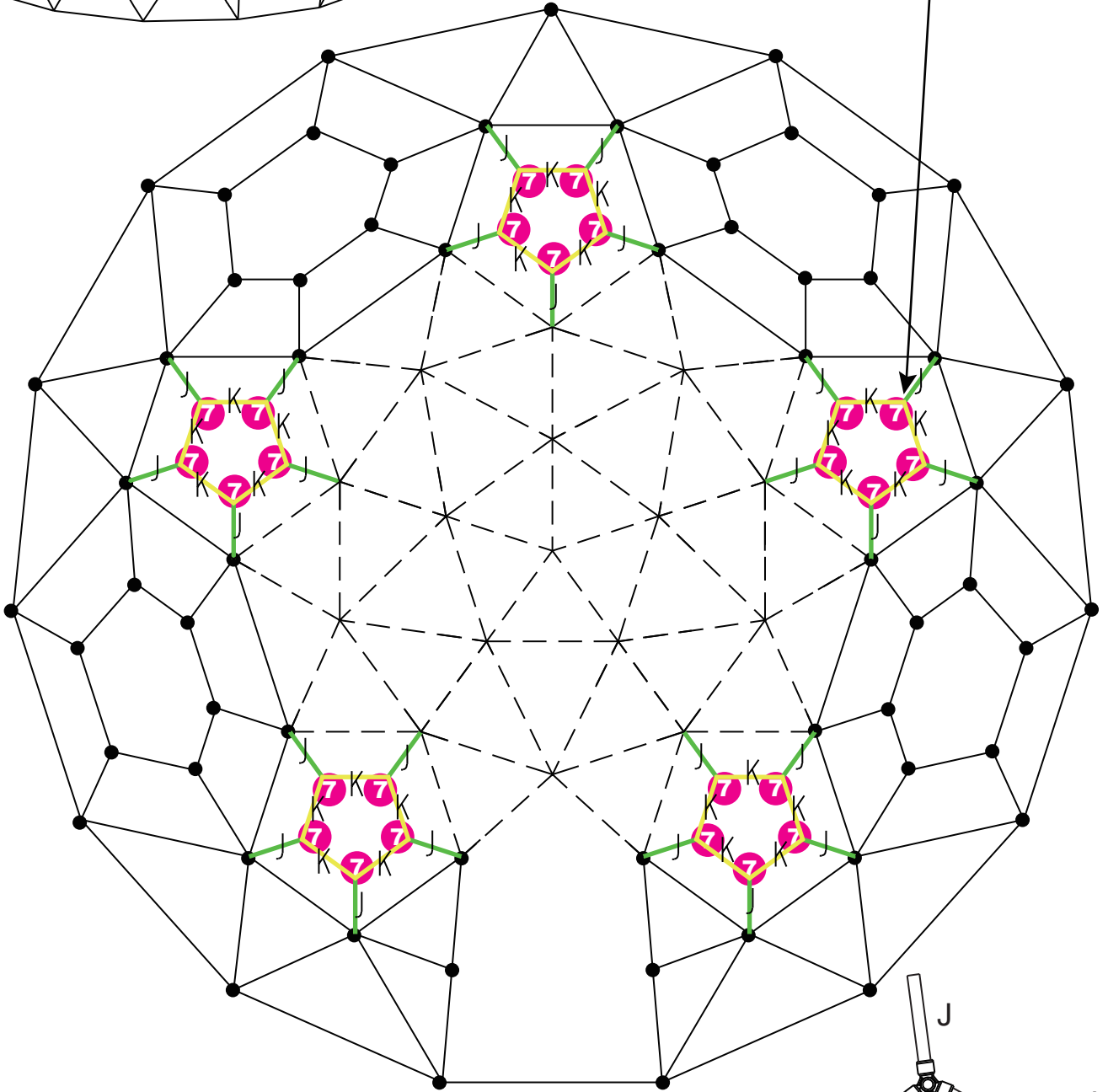
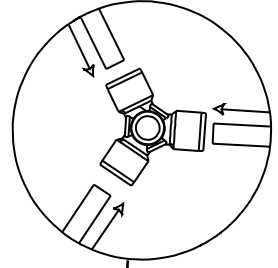
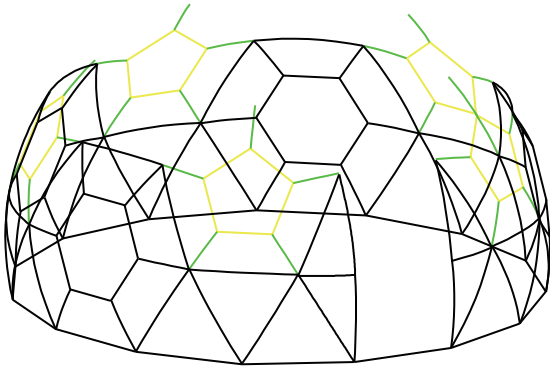

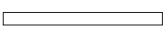
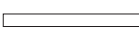
J  25pcs  
 K  25pcs



**7** × 25

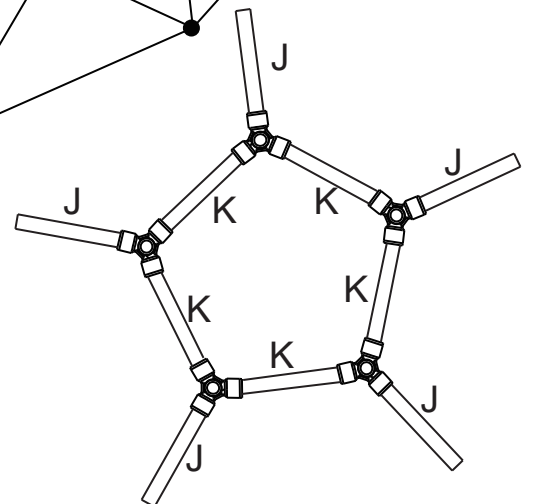

# Step-09

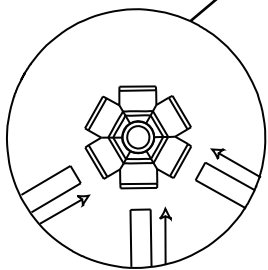
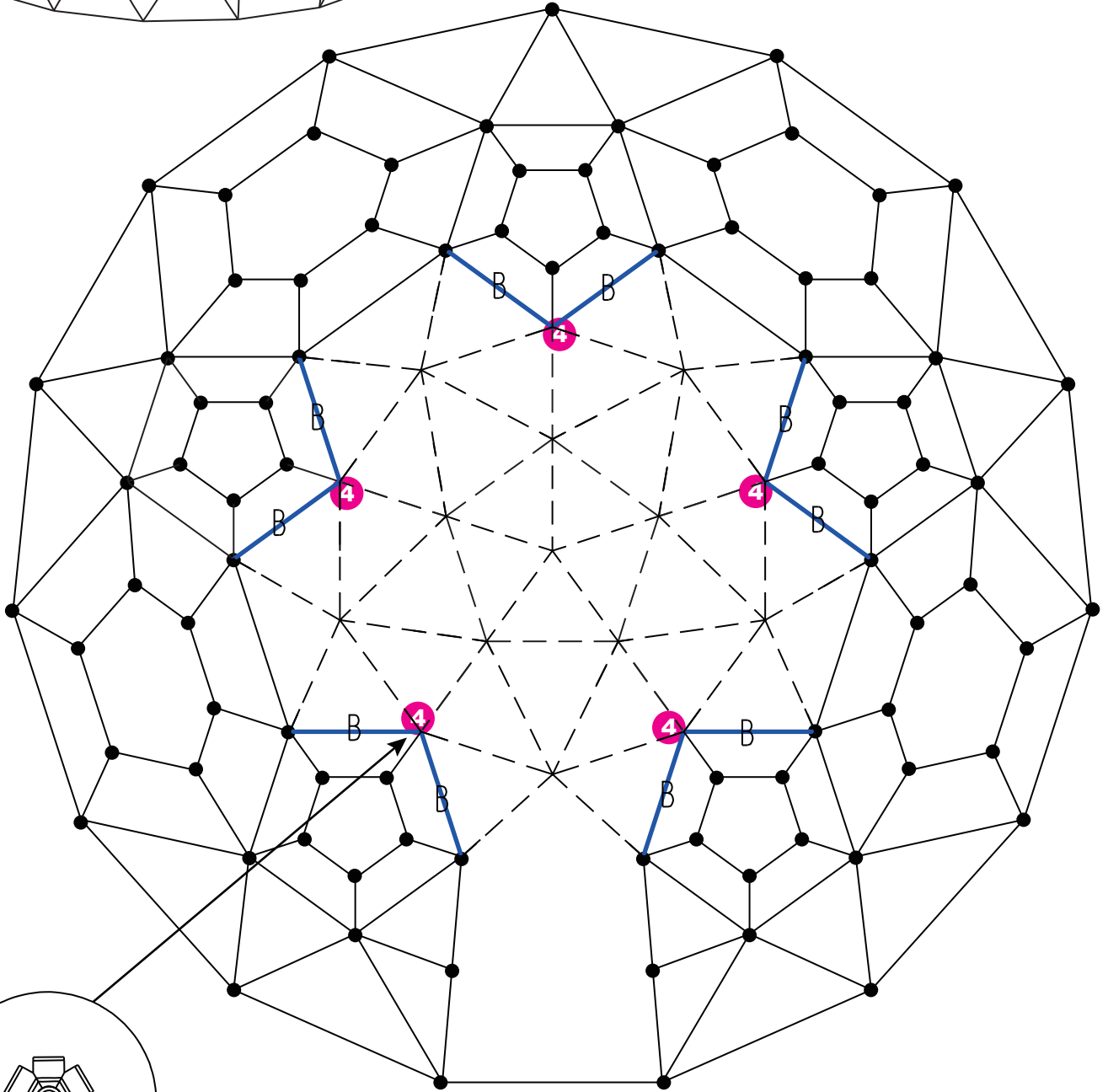
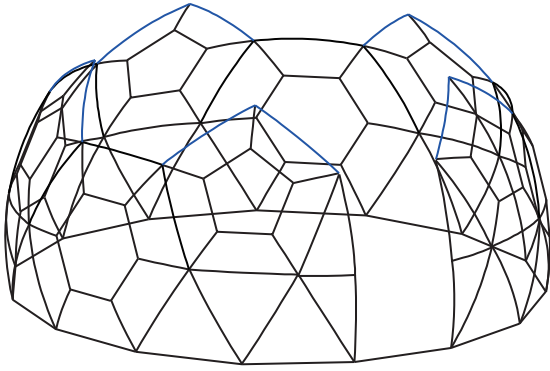

B  10pcs

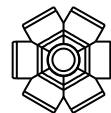

4 x 5

# Step-10

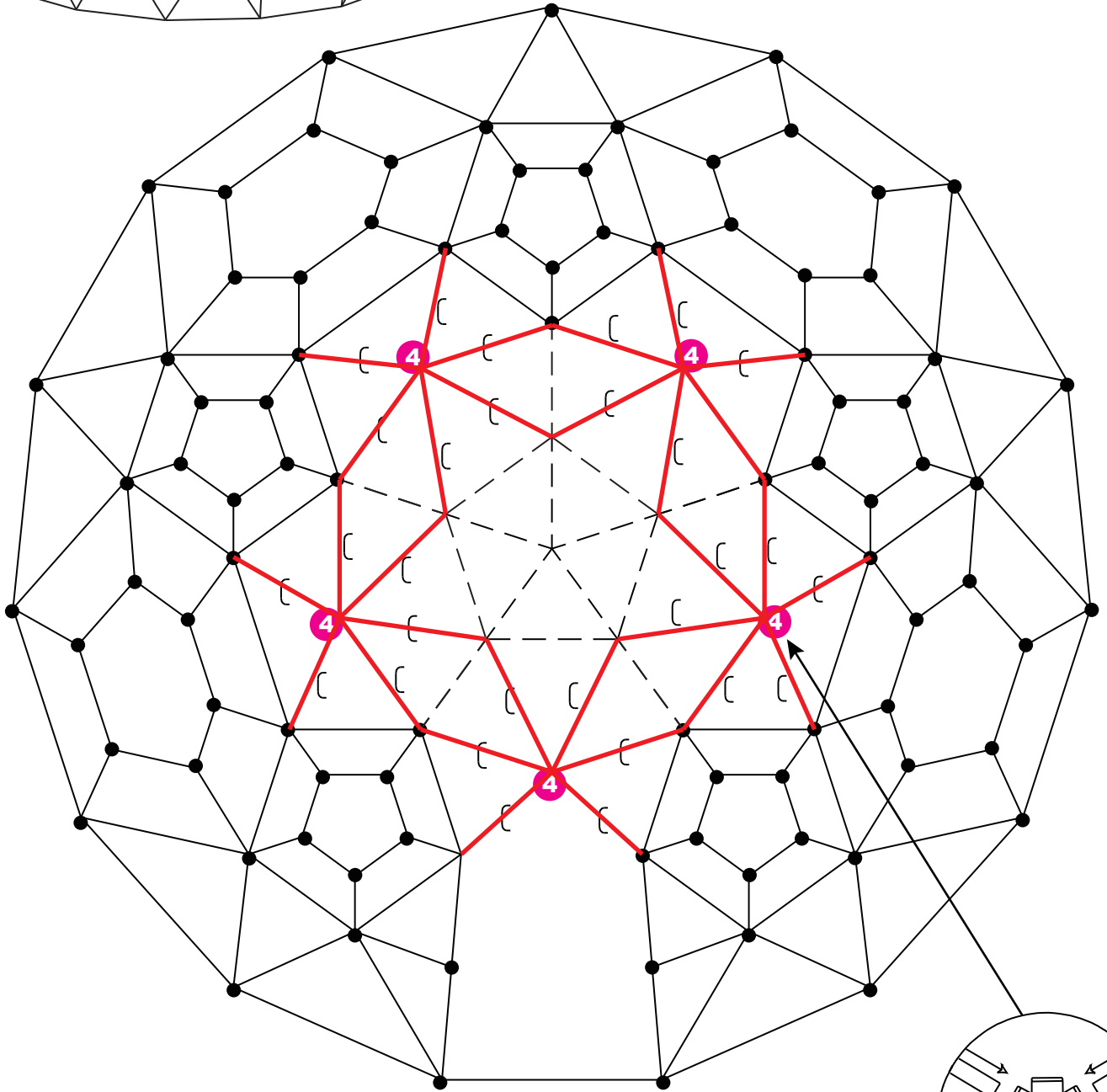
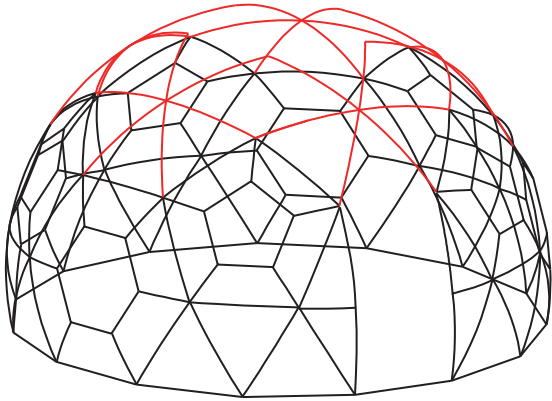

C   
71cm / 30pcs

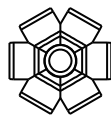

4 x 5

# Step-11

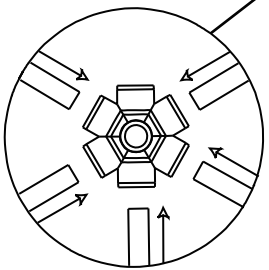
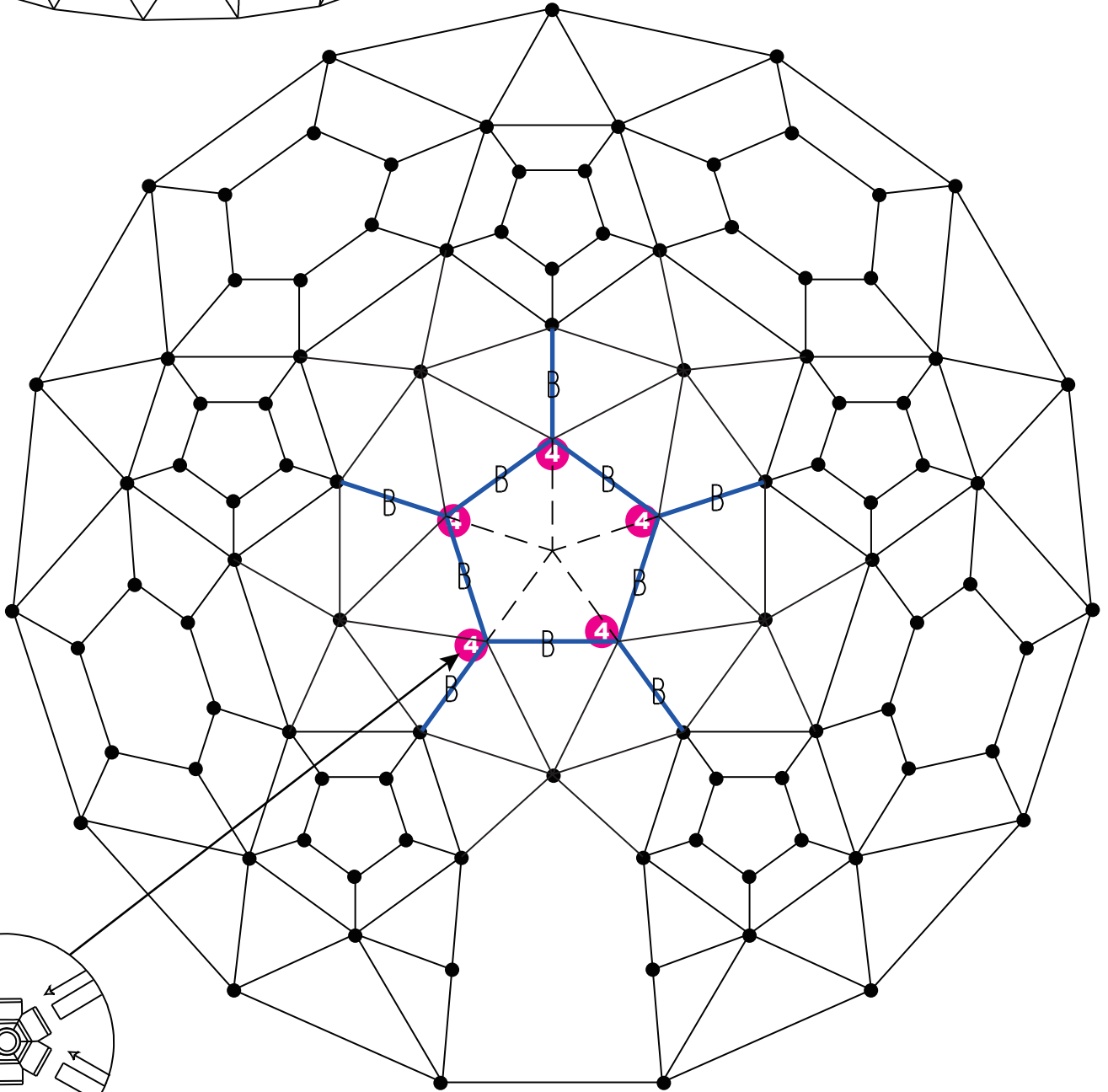
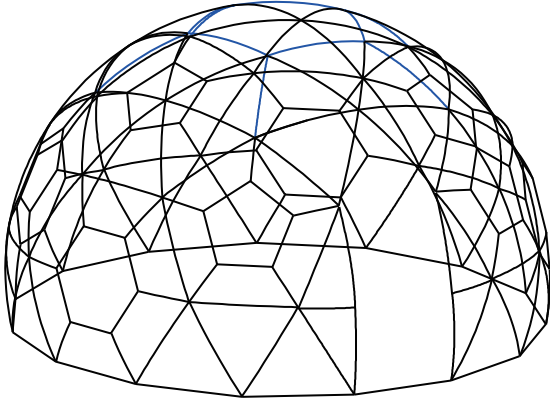

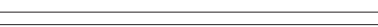

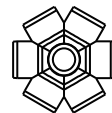
B   
10pcs

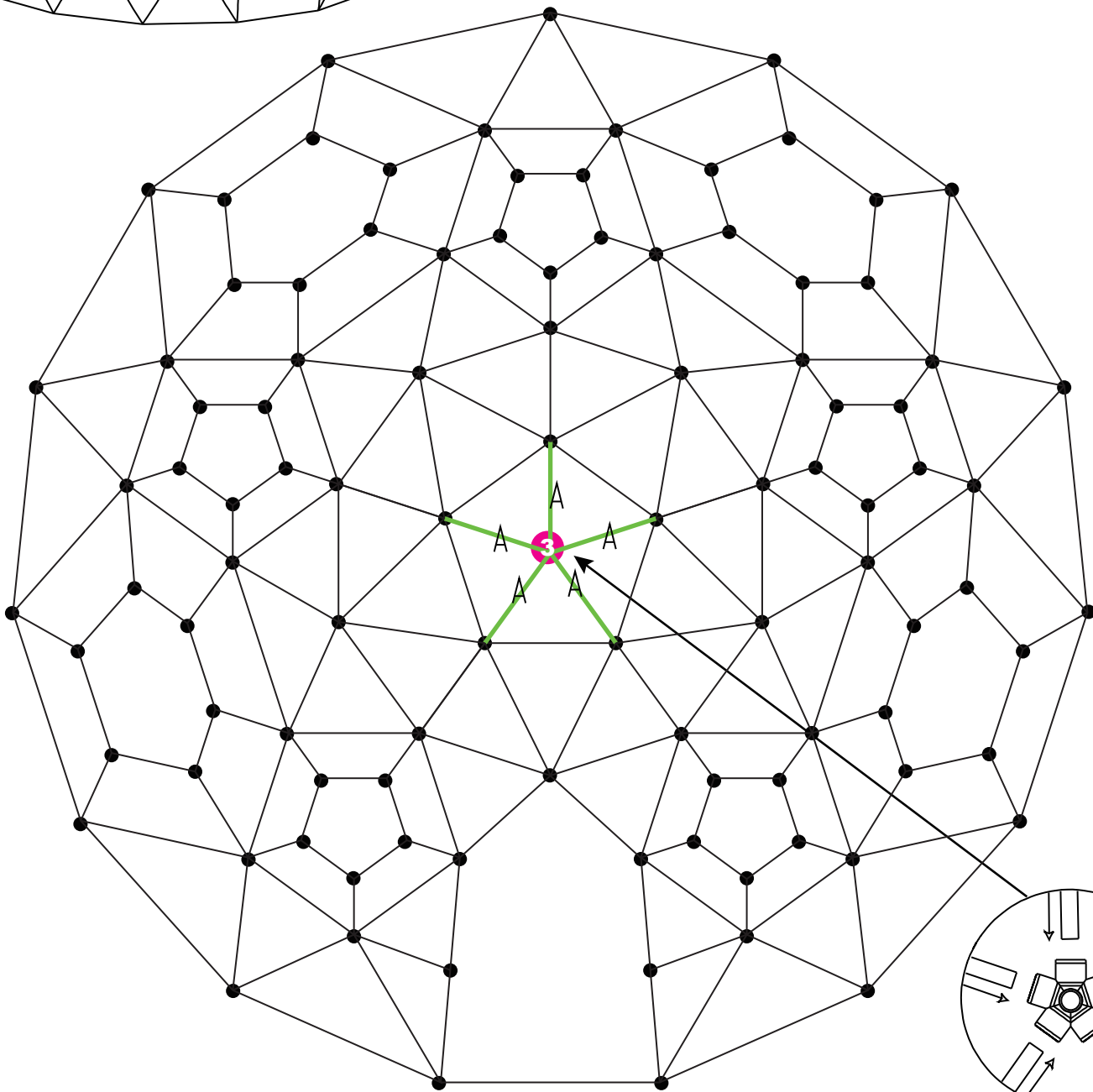
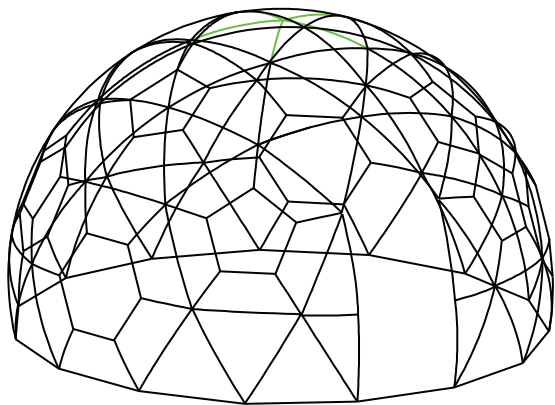

4 × 5

# Step-12



A  5pcs

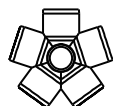

**3** × 1

# Step-13

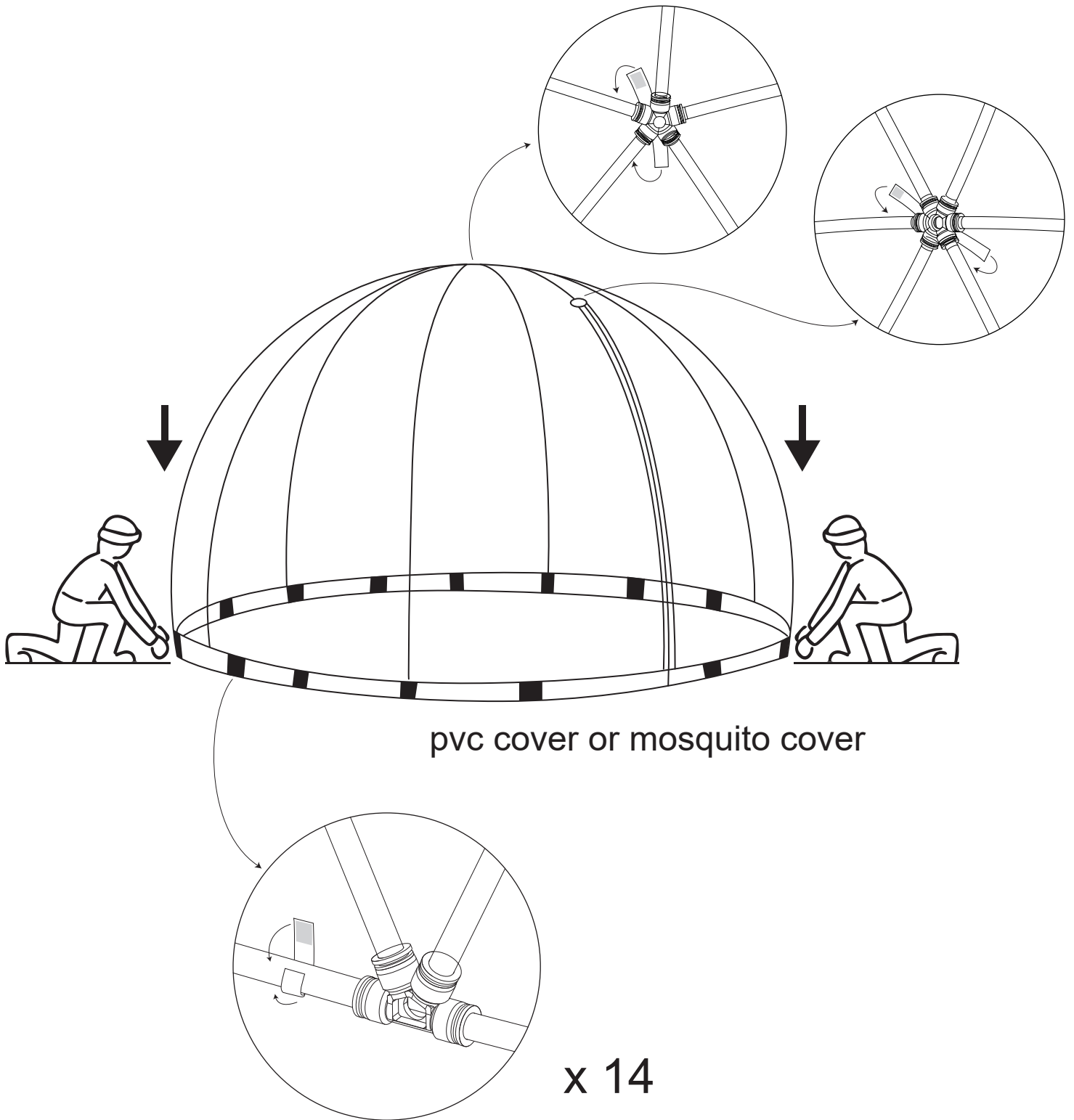

# Step-14

## Option 1

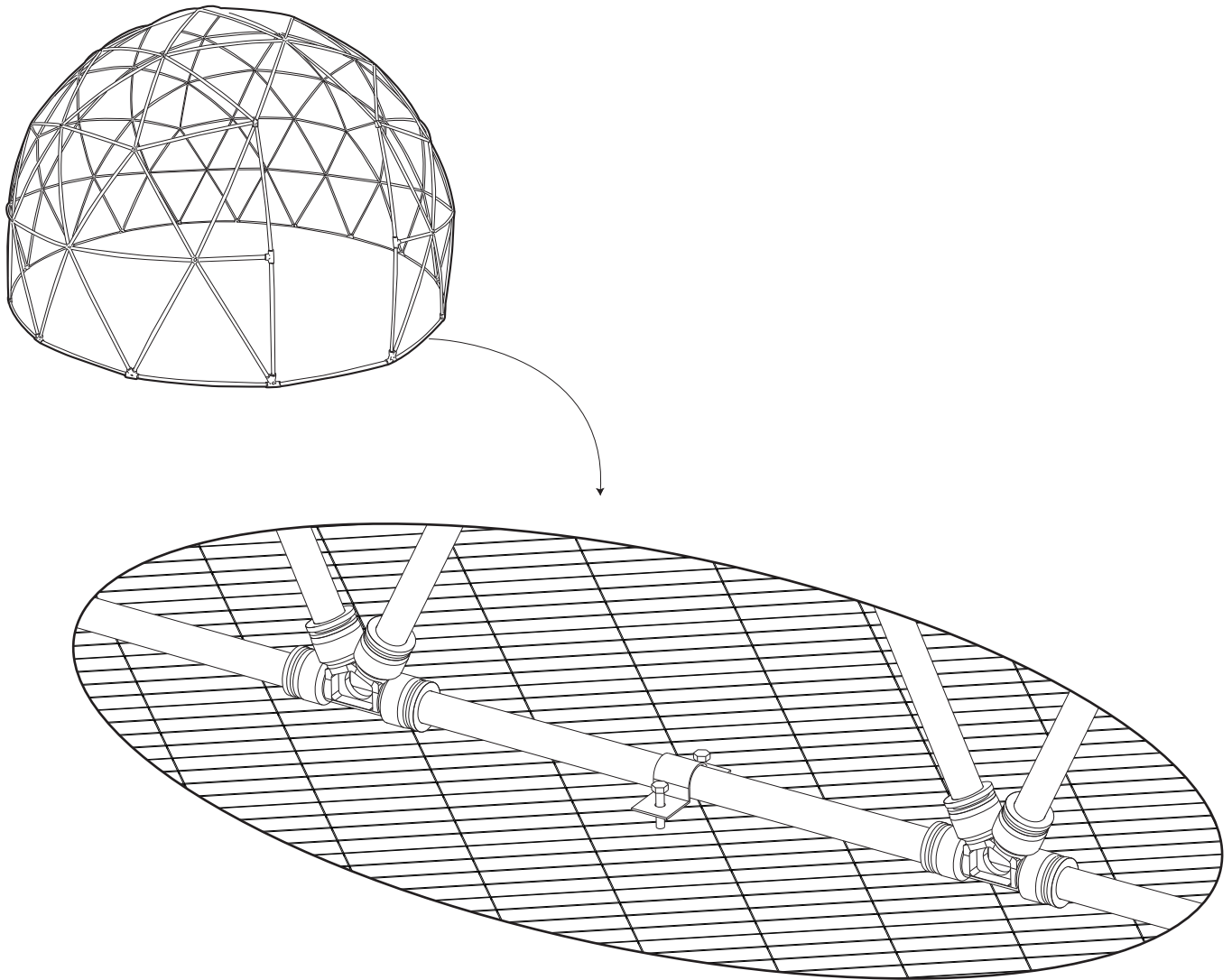

Install on the wood / wpc floor

# Step-15

## Option 2

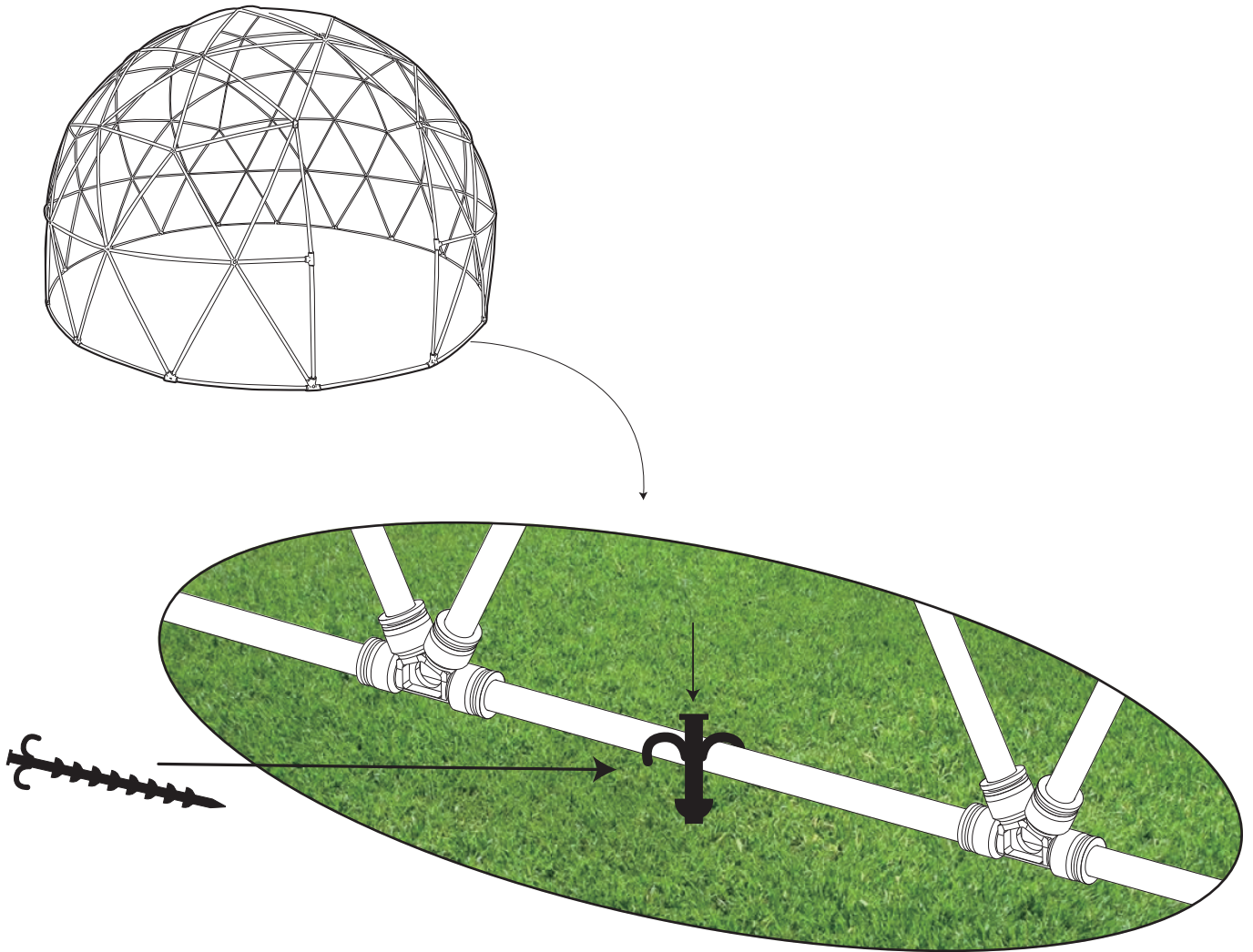

Install on the grass floor

# Step-16

## Option 3: sandbag

Caution: to avoid wind break  
sandbag is necessary, 14pc

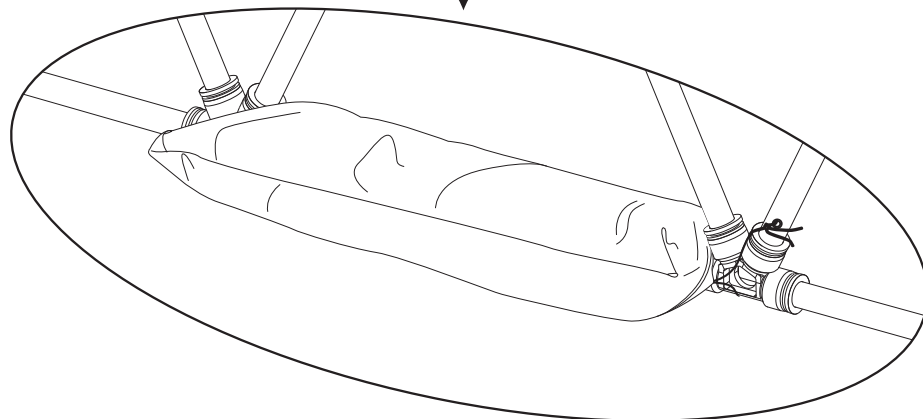
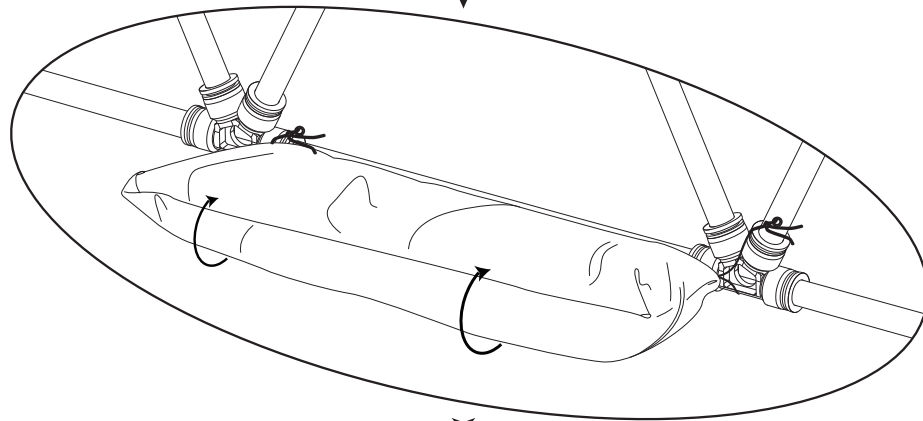
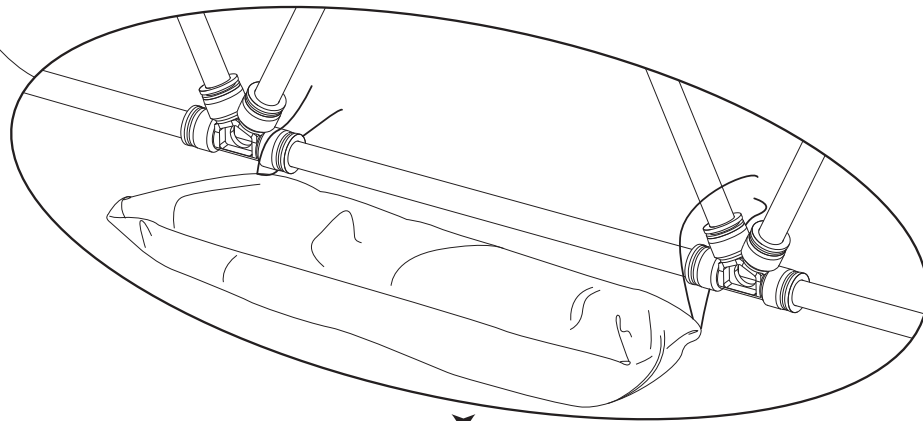
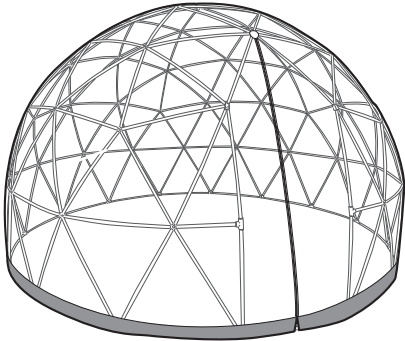

# Step-17

tips:

The PVC cover will have slight wrinkles after the first assembly. Staying under the sun for about an hour will improve wrinkles.



**WARNING**

**KEEP ALL FLAME AND HEAT SOURCES  
AWAY FROM THIS DOME FABRIC**

**Manufacturer:**Shanghaimuxinmuyeyouxiangongsi

**Address:** Shuangchenglu 803nong11hao1602A-1609shi, baoshanqu, shanghai 200000 CN.

**Imported to AUS:** SIHAO PTY LTD. 1 ROKEVA STREETEASTWOOD NSW 2122 Australia

**Imported to USA:** Sanven Technology Ltd. Suite 250, 9166 Anaheim Place, Rancho Cucamonga, CA 91730

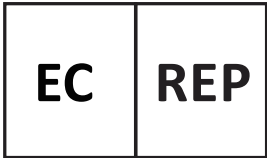

E-CrossStu GmbH  
Mainzer Landstr.69, 60329 Frankfurt am Main.



YH CONSULTING LIMITED.  
C/O YH Consulting Limited Office 147, Centurion House,  
London Road, Staines-upon-Thames, Surrey, TW18 4AX



**VEVOR**<sup>®</sup>

**TOUGH TOOLS, HALF PRICE**

**Technical Support and E-Warranty Certificate**

**[www.vevor.com/support](http://www.vevor.com/support)**

# **VEVOR<sup>®</sup>**

## **TOUGH TOOLS, HALF PRICE**

Technical Support and E-Warranty Certificate [www.vevor.com/support](http://www.vevor.com/support)

## **GARTEN OUTDOOR CLEAR DOOM**

### **BENUTZERHANDBUCH**

Wir sind weiterhin bestrebt, Ihnen Werkzeuge zu wettbewerbsfähigen Preisen anzubieten. „Sparen Sie die Hälfte“, „Halber Preis“ oder andere ähnliche Ausdrücke, die wir verwenden, stellen nur eine Schätzung der Ersparnis dar, die Sie beim Kauf bestimmter Werkzeuge bei uns im Vergleich zu den großen Topmarken erzielen können, und decken nicht unbedingt alle von uns angebotenen Werkzeugkategorien ab. Wir möchten Sie freundlich daran erinnern, bei Ihrer Bestellung bei uns sorgfältig zu prüfen, ob Sie im Vergleich zu den großen Topmarken tatsächlich die Hälfte sparen.

**VEVOR**<sup>®</sup>  
TOUGH TOOLS, HALF PRICE

GARTEN AUSSENBEREICH KLAR  
UNTERGANG

Model: GB-DOME-12, GB-DOME-12T, GB-DOME-9.5 GB-DOME-9.5T

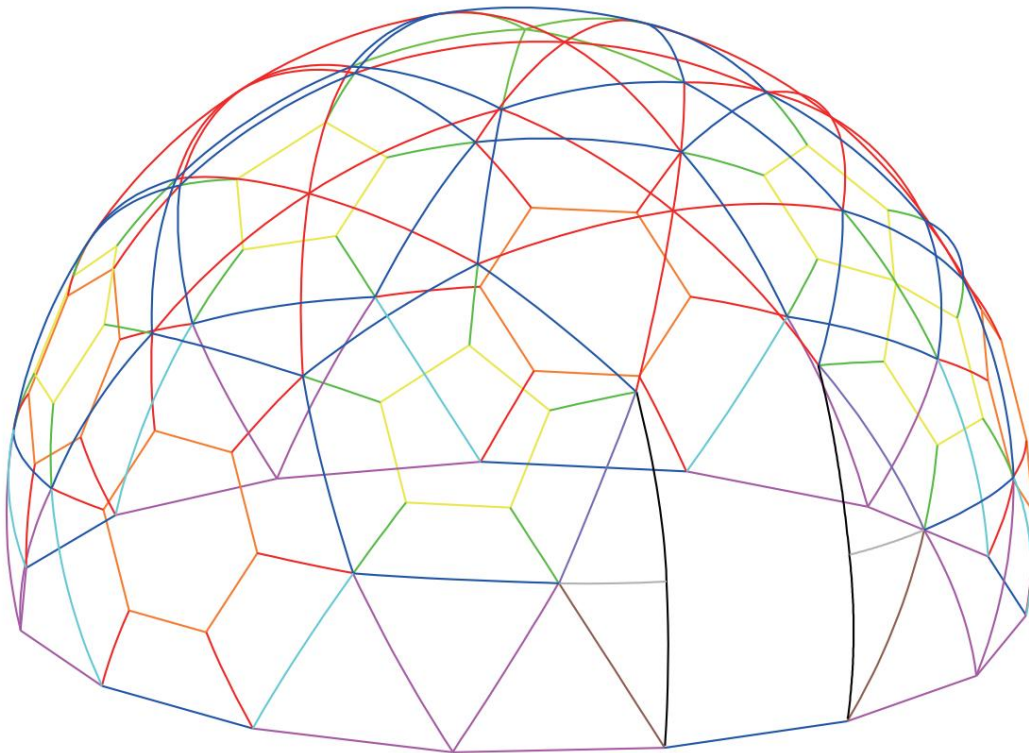

Brauchen Sie Hilfe? Kontaktieren Sie uns!

Haben Sie Fragen zum Produkt? Benötigen Sie technischen Support? Bitte kontaktieren Sie uns: Technischer Support und E-Garantie-Zertifikat [www.vevor.com/support](http://www.vevor.com/support)

Dies ist die Originalanleitung. Bitte lesen Sie alle Anweisungen sorgfältig durch, bevor Sie das Gerät in Betrieb nehmen. VEVOR behält sich eine klare Auslegung unserer Bedienungsanleitung vor. Das Erscheinungsbild des Produkts richtet sich nach dem Produkt, das Sie erhalten haben. Bitte verzeihen Sie uns, dass wir Sie nicht erneut informieren, wenn es Technologie- oder Software-Updates für unser Produkt gibt.

# SPEZIFIKATIONEN

Modell	GB-DOME-12
Produktgröße	12 Fuß
Farbe	Transparent
Tragfähigkeit	110 Pfund

Modell	GB-DOME-12T
Produktgröße	12 Fuß
Farbe	Transparent
Tragfähigkeit	110 Pfund

Modell	GB-DOME-9.5
Produktgröße	9,5 Fuß
Farbe	Transparent
Tragfähigkeit	110 Pfund







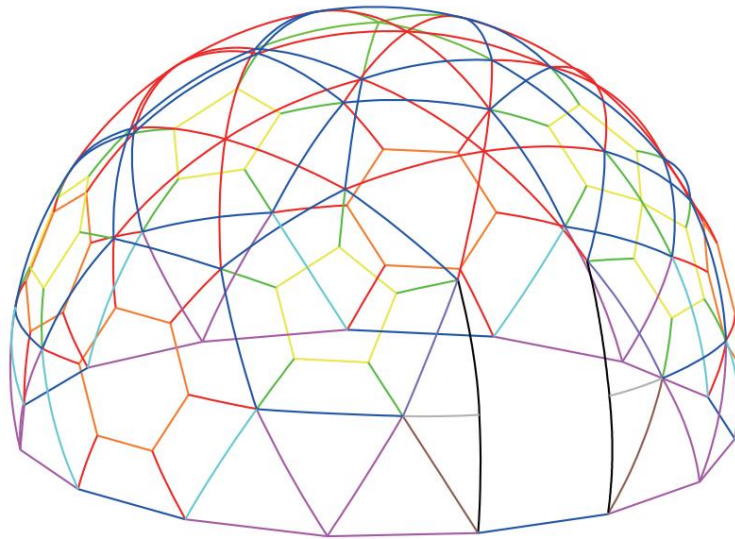

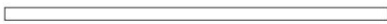

Modell	GB-DOME-9.5T
Produktgröße	9,5 Fuß
Farbe	Transparent
Tragfähigkeit	110 Pfund

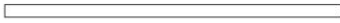
# Zubehör

Modell	Transparente PVC-Abdeckung	Moskitonetz
GB-DOME-12	✓	✗
GB-DOME-12T	✓	✓
GB-DOME-9.5	✓	✗
GB-DOME-9.5T	✓	✓



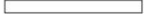

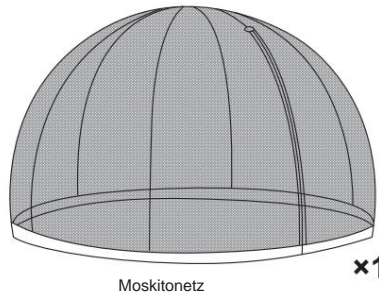
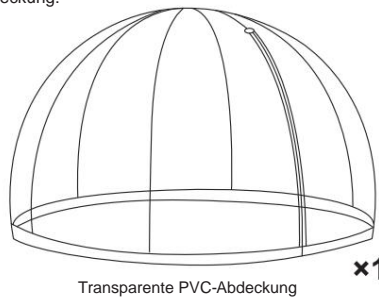

## Rohre:

- A  5 Stück
- B  42 Stück
- C  50 Stück
- D  4 Stück
- E  8 Stück
- G  2 Stück
- H  2 Stück
-  2 Stück
- J  25 Stück
- K  25 Stück
- M  24 Stück
- M  24 Stück







## Abdeckung:

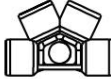

## Standardzubehör:

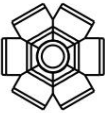
-  x10
-  x10
- 9,5 Fuß  x10
- 12 Fuß  x14

## Anschlüsse:

-  1 x2
-  x13
-  x1
-  x33
-  x2
-  6 x2
-  7 x49

# Schritt-01

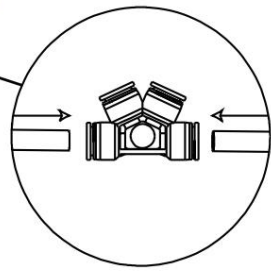
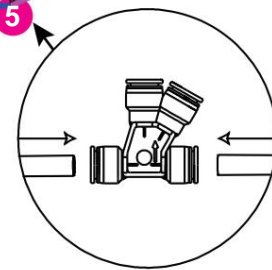
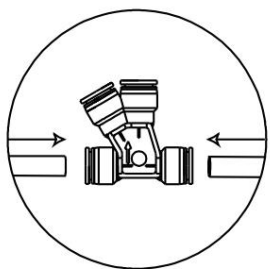
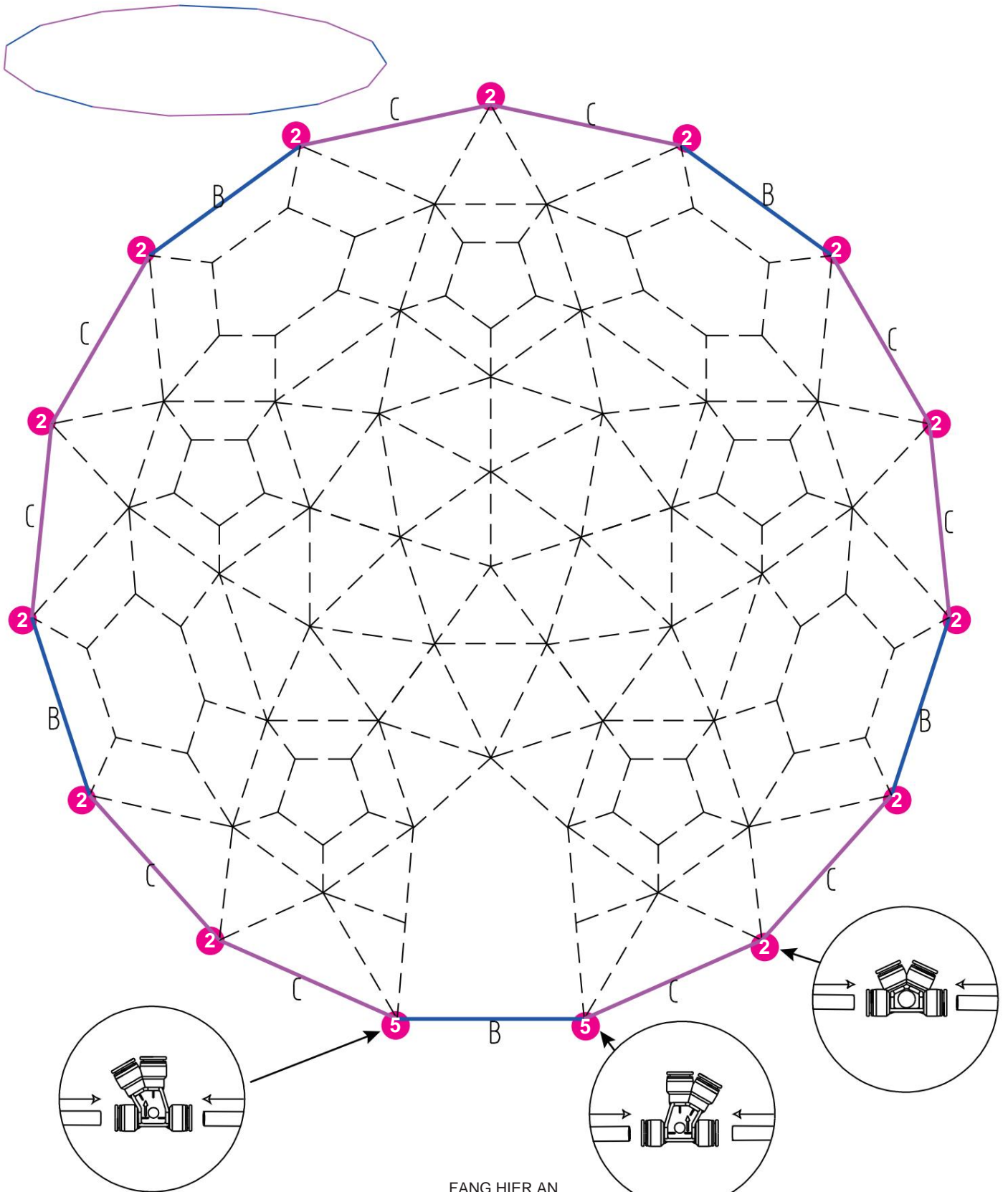

FANG HIER AN

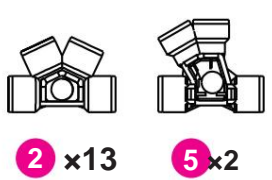
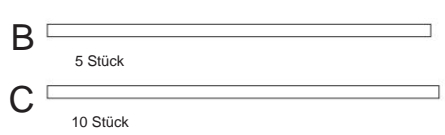
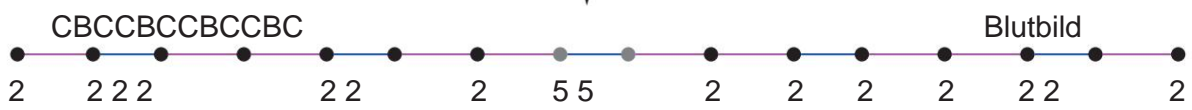

# Schritt-02

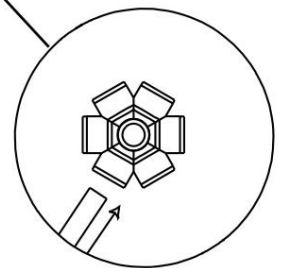
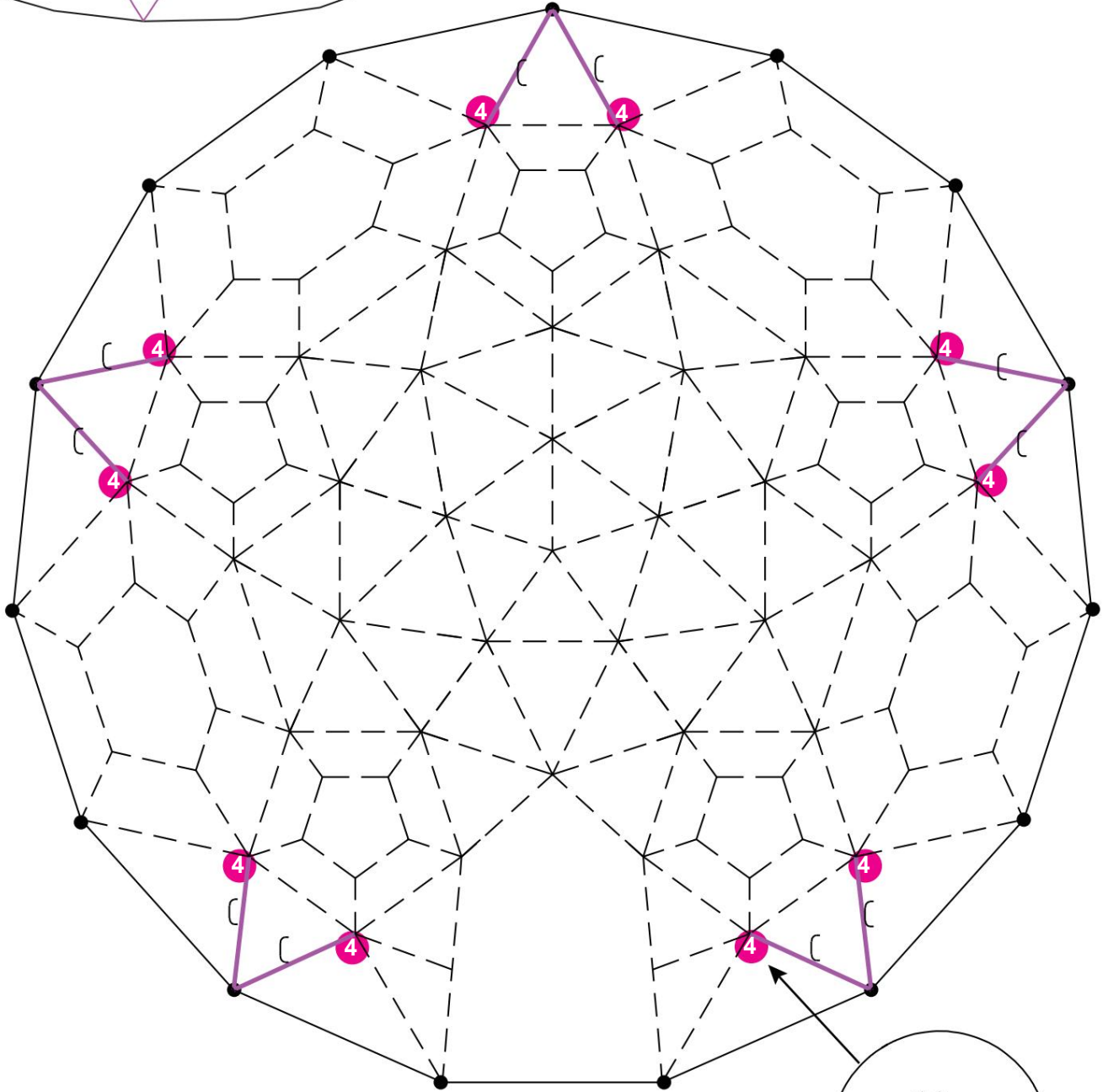
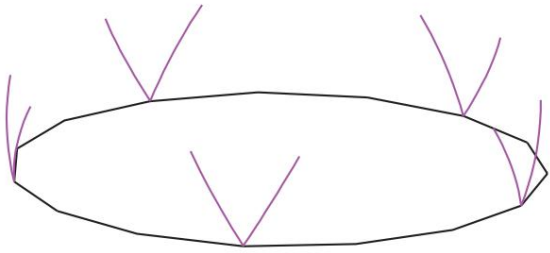

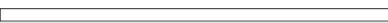
C   
10 Stück

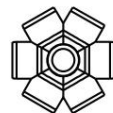

4 x10

# Schritt-03

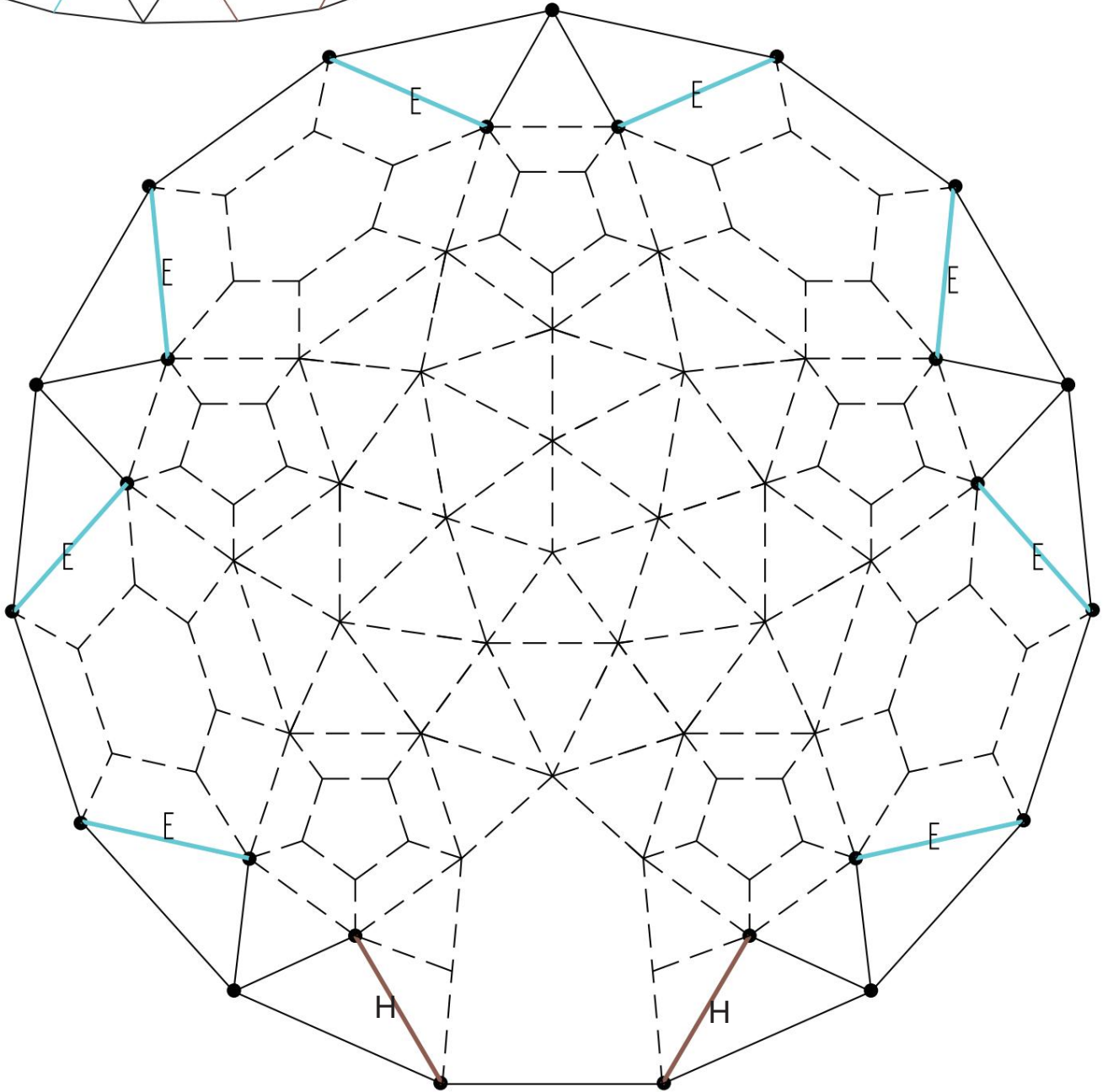
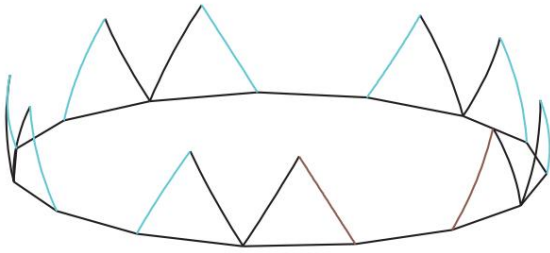

E   
8 Stück

H   
2 Stück



# Schritt-04

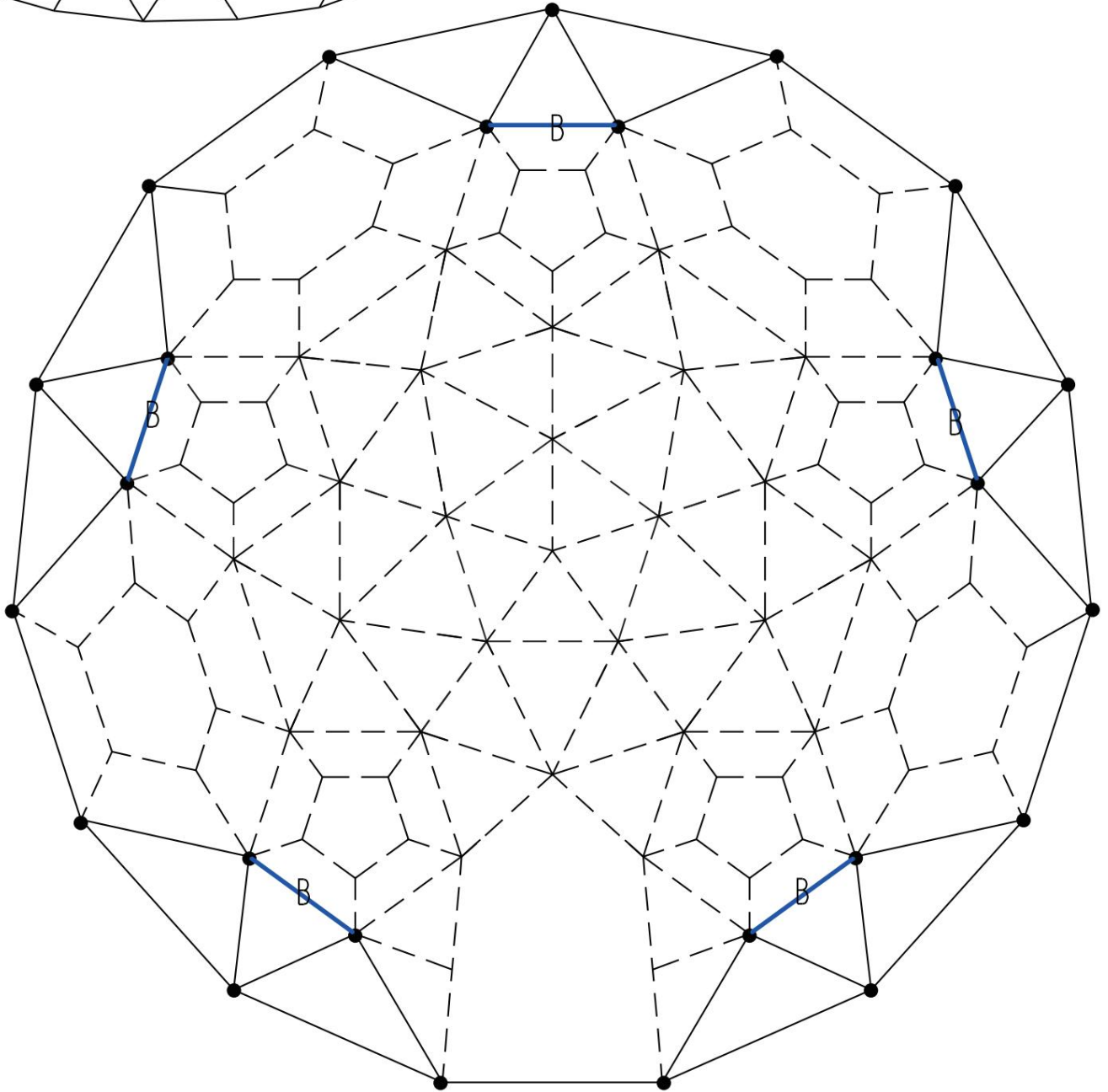
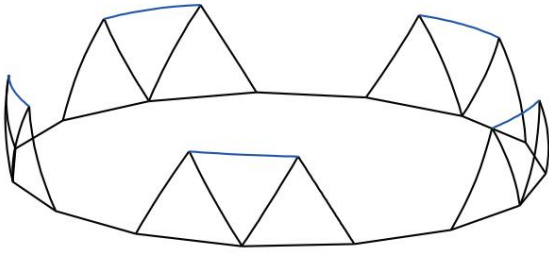

B   
5 Stück



# Schritt-05

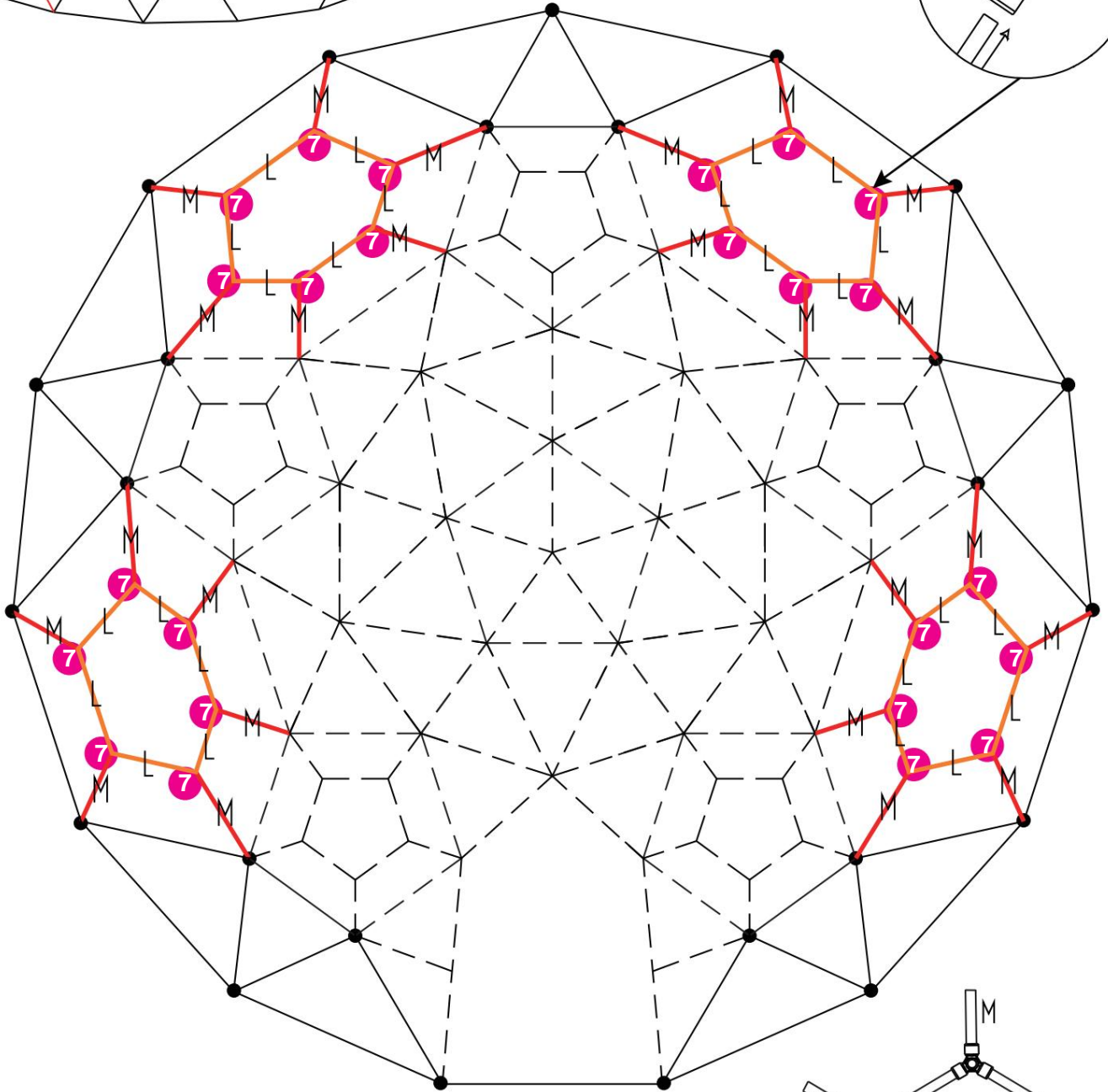
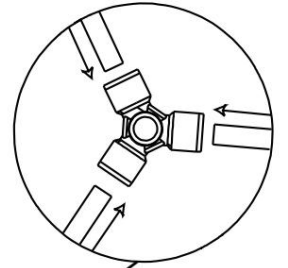
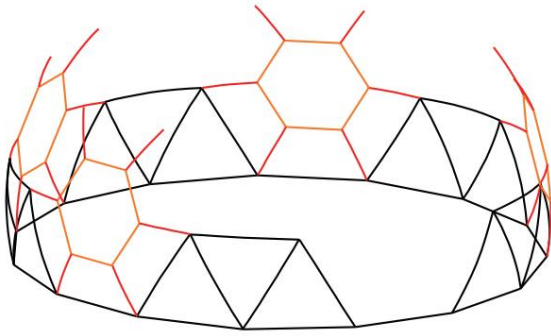

M  24 Stück

M  24 Stück



**7** x24

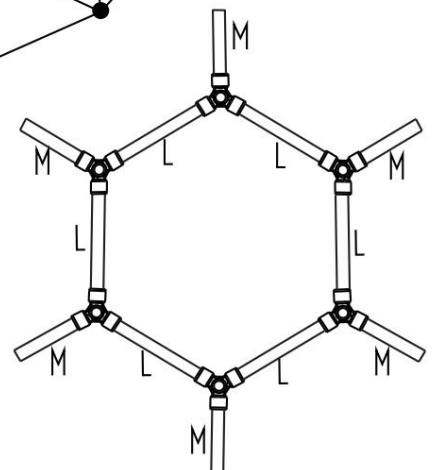

# Schritt-06

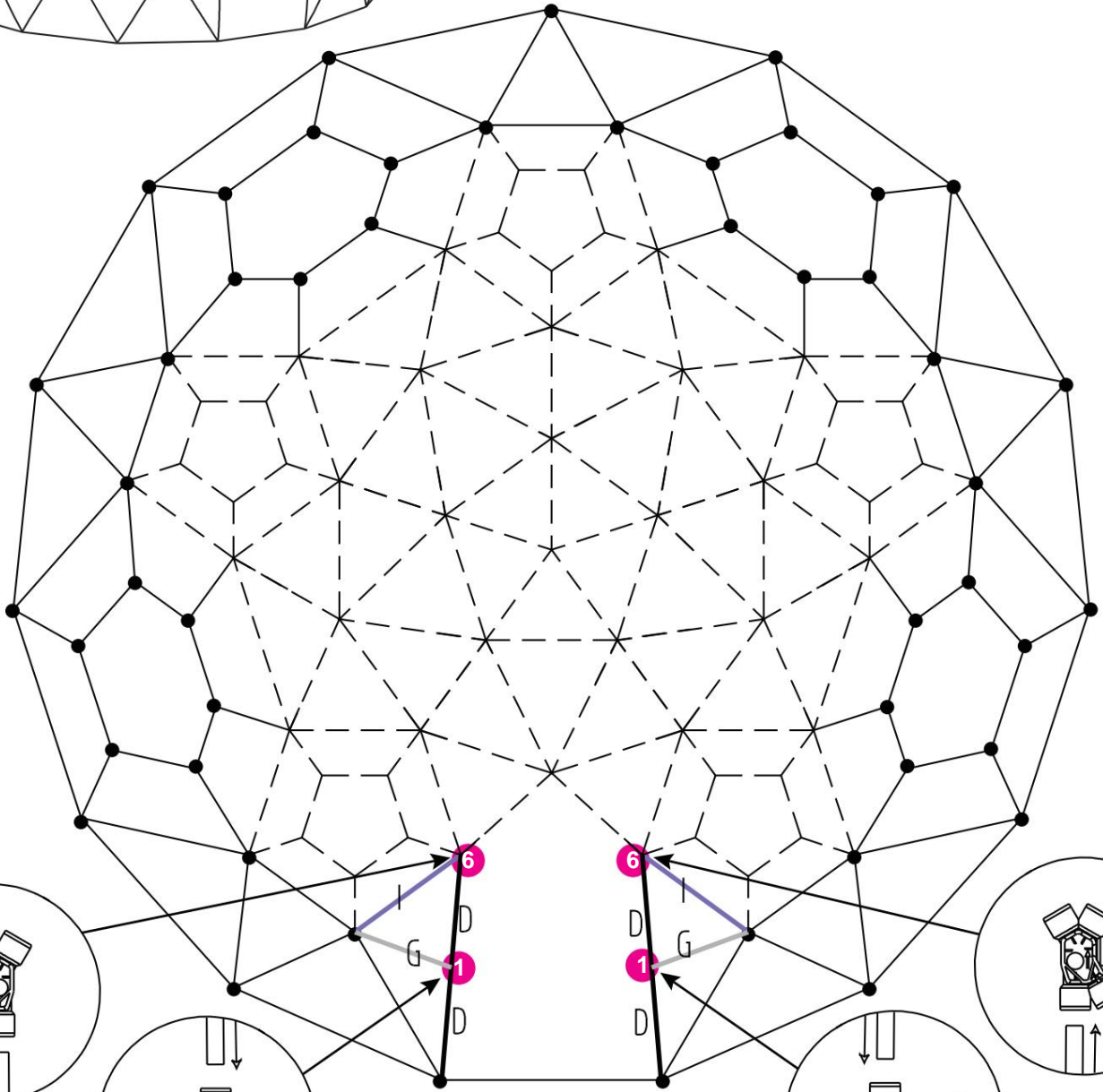
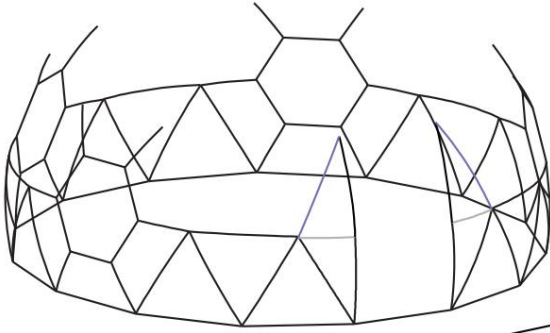

D   
4 Stück

G   
2 Stück

  
2 Stück

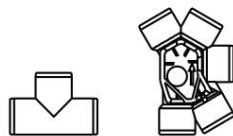

**1** x2

**x2**



# Schritt-07

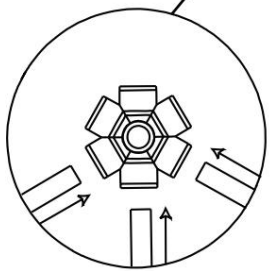
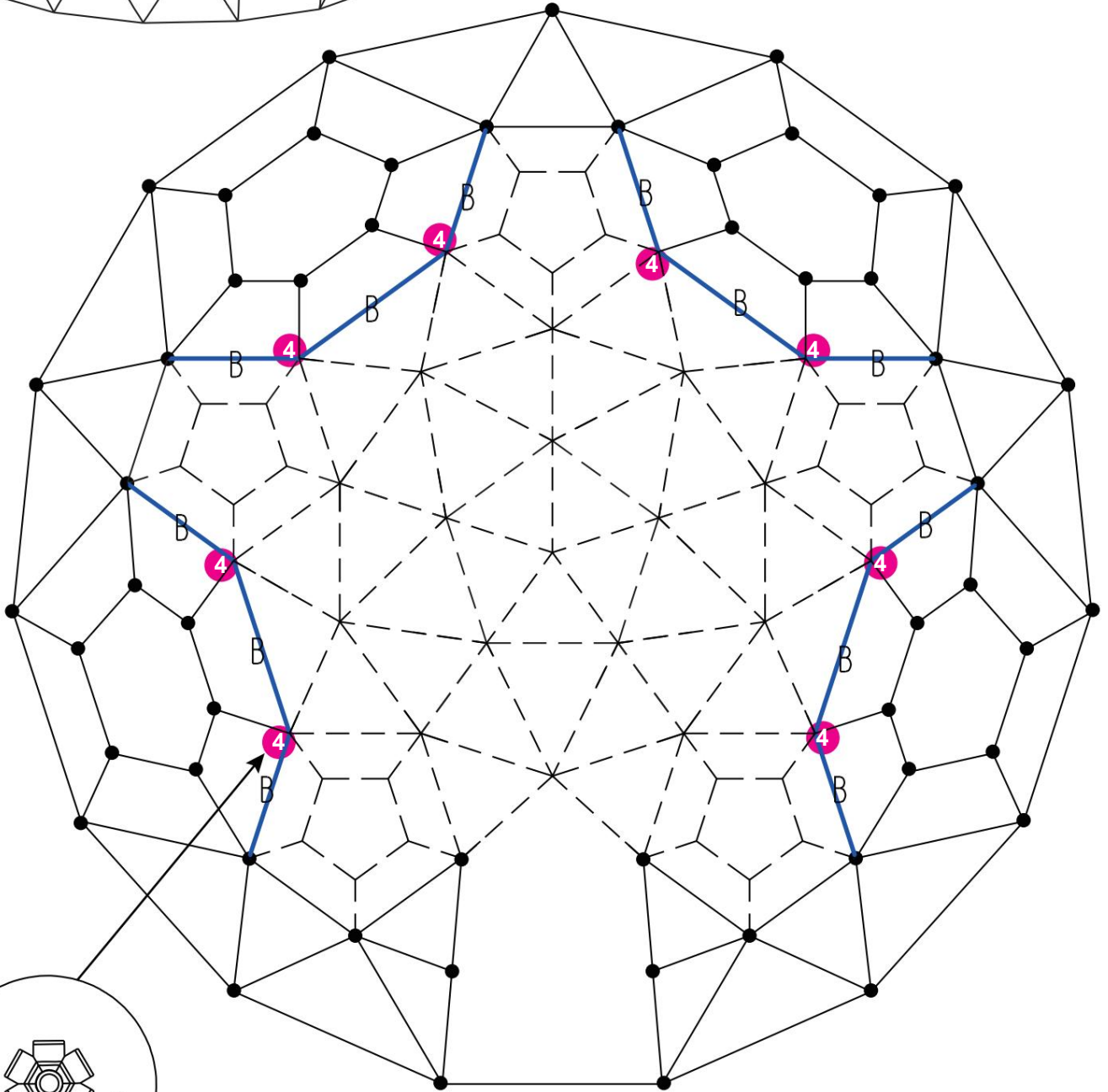
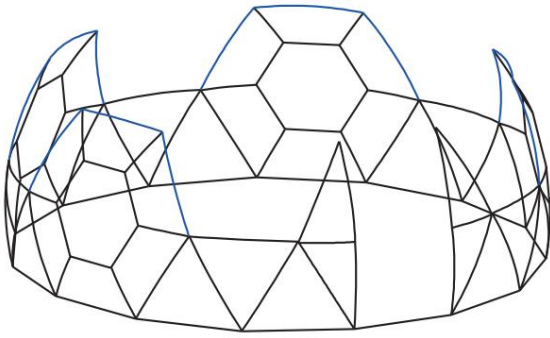



B  12 Stück

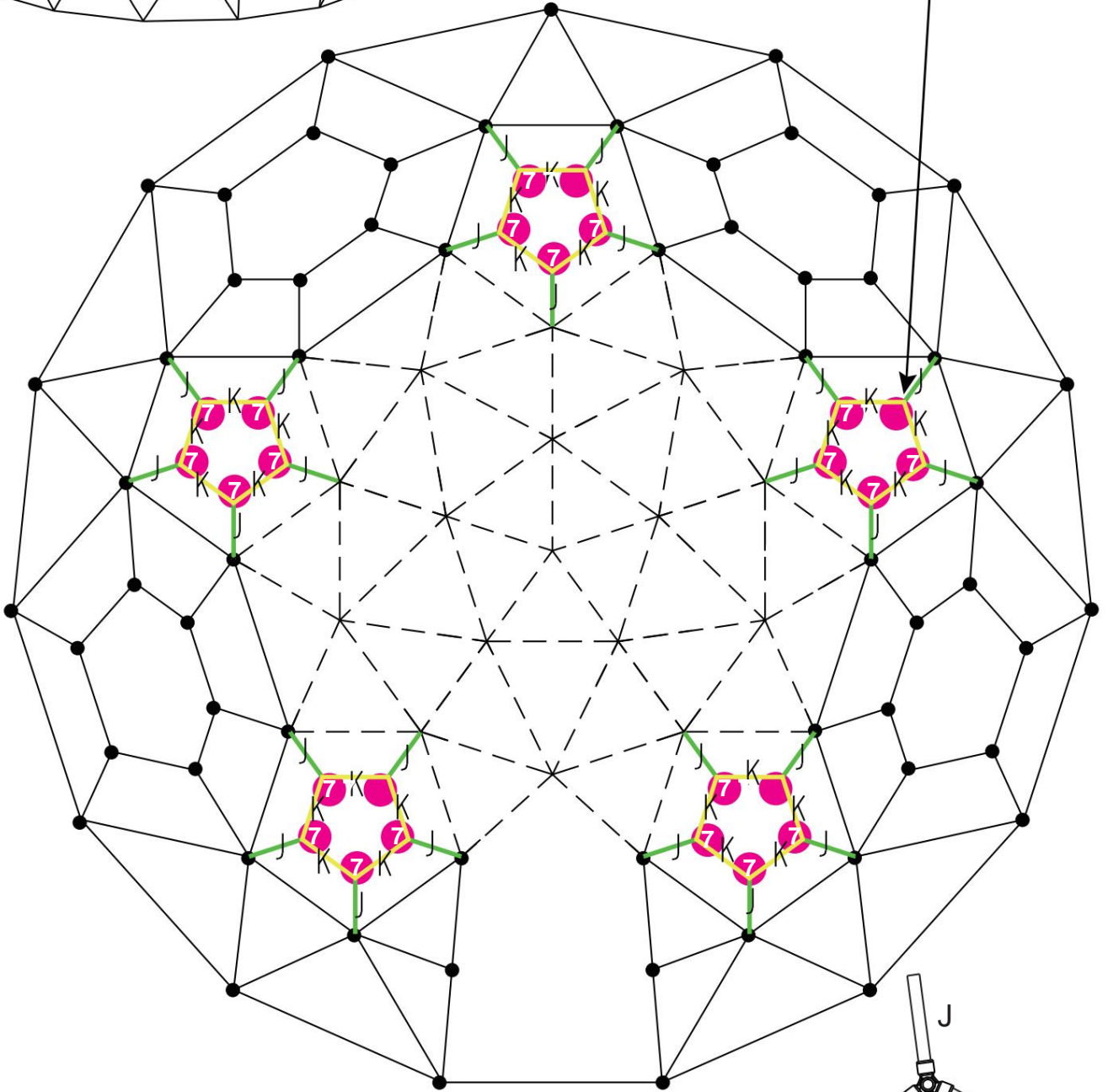
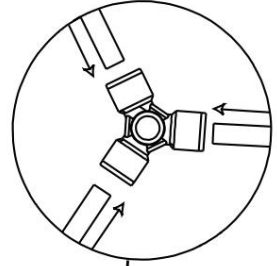
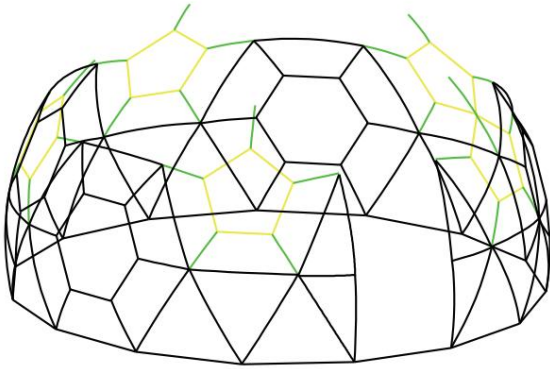

4 x 8

# Schritt-08



J  25 Stück  
K  25 Stück



 x25

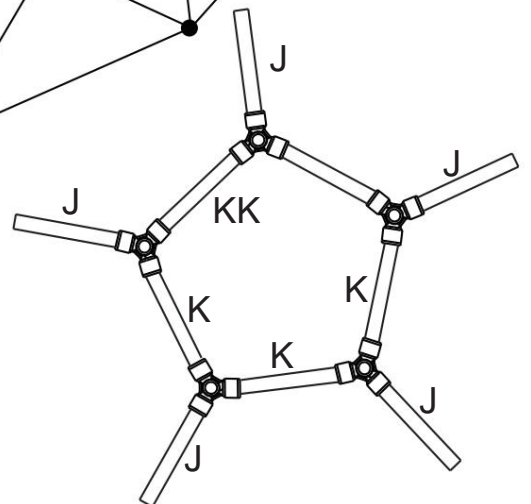

# Schritt-09

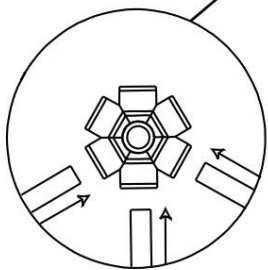
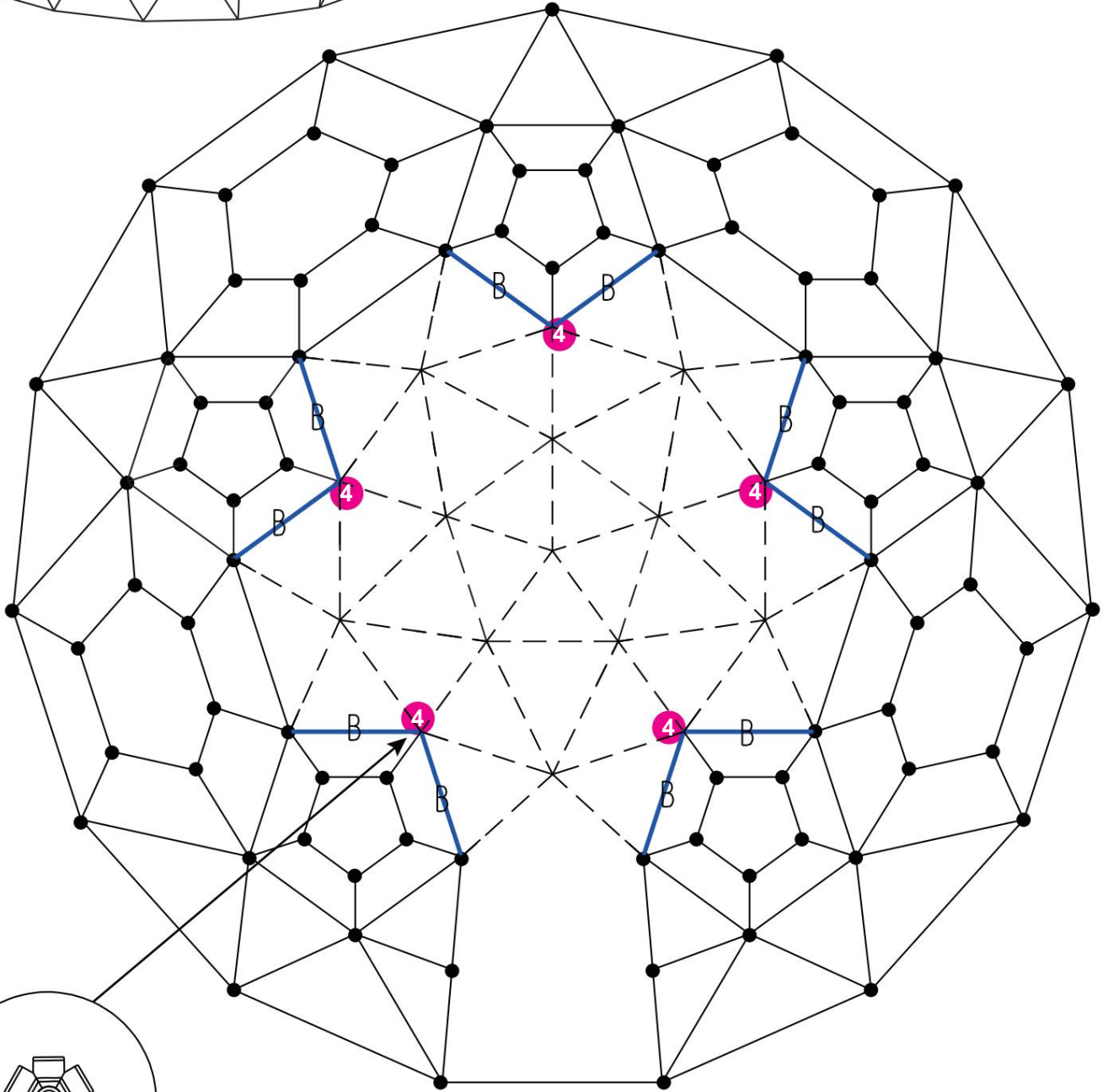
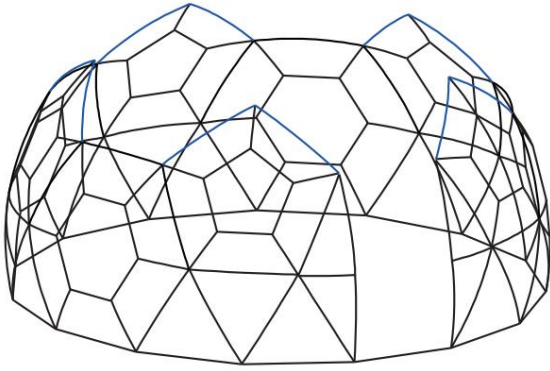

B  10 Stück

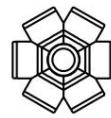

4 x5

# Schritt 10

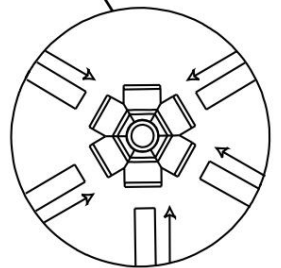
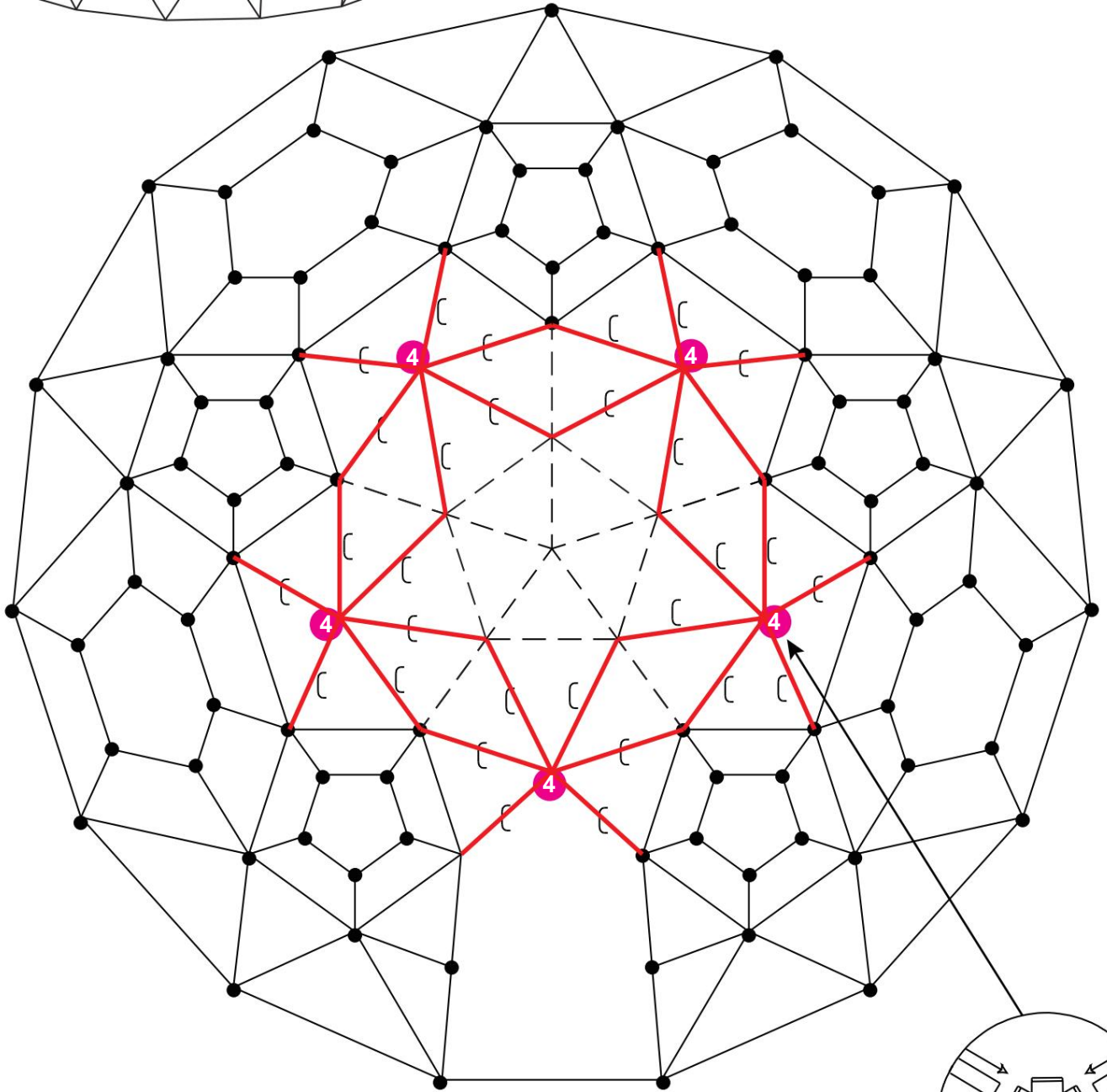
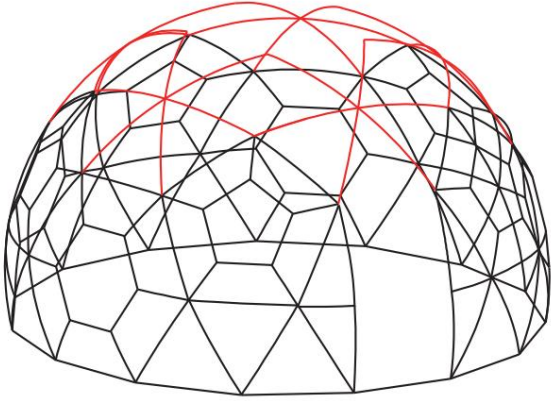

C   
71 cm / 30 Stück

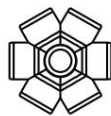

4 x5

# Schritt 11

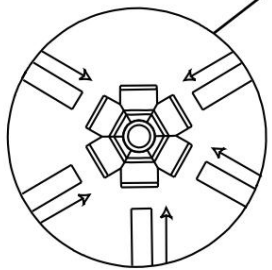
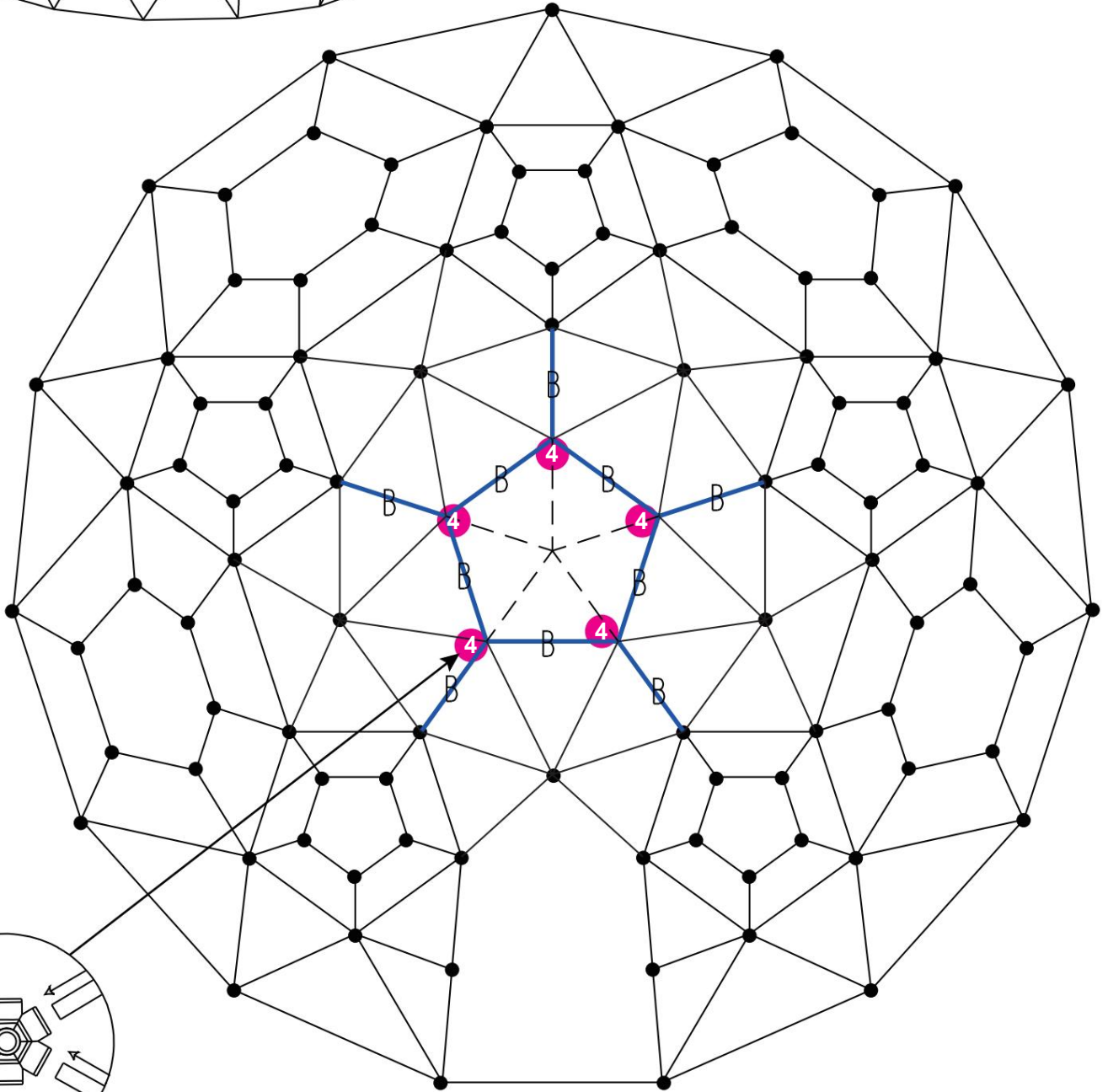
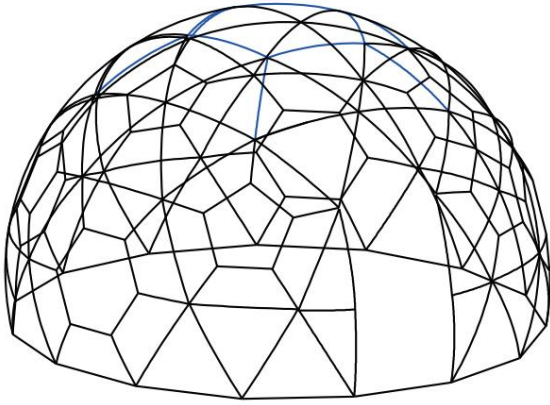

B   
10 Stück

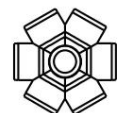

4 x 5

# Schritt-12

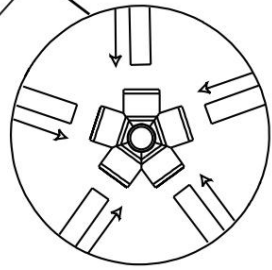
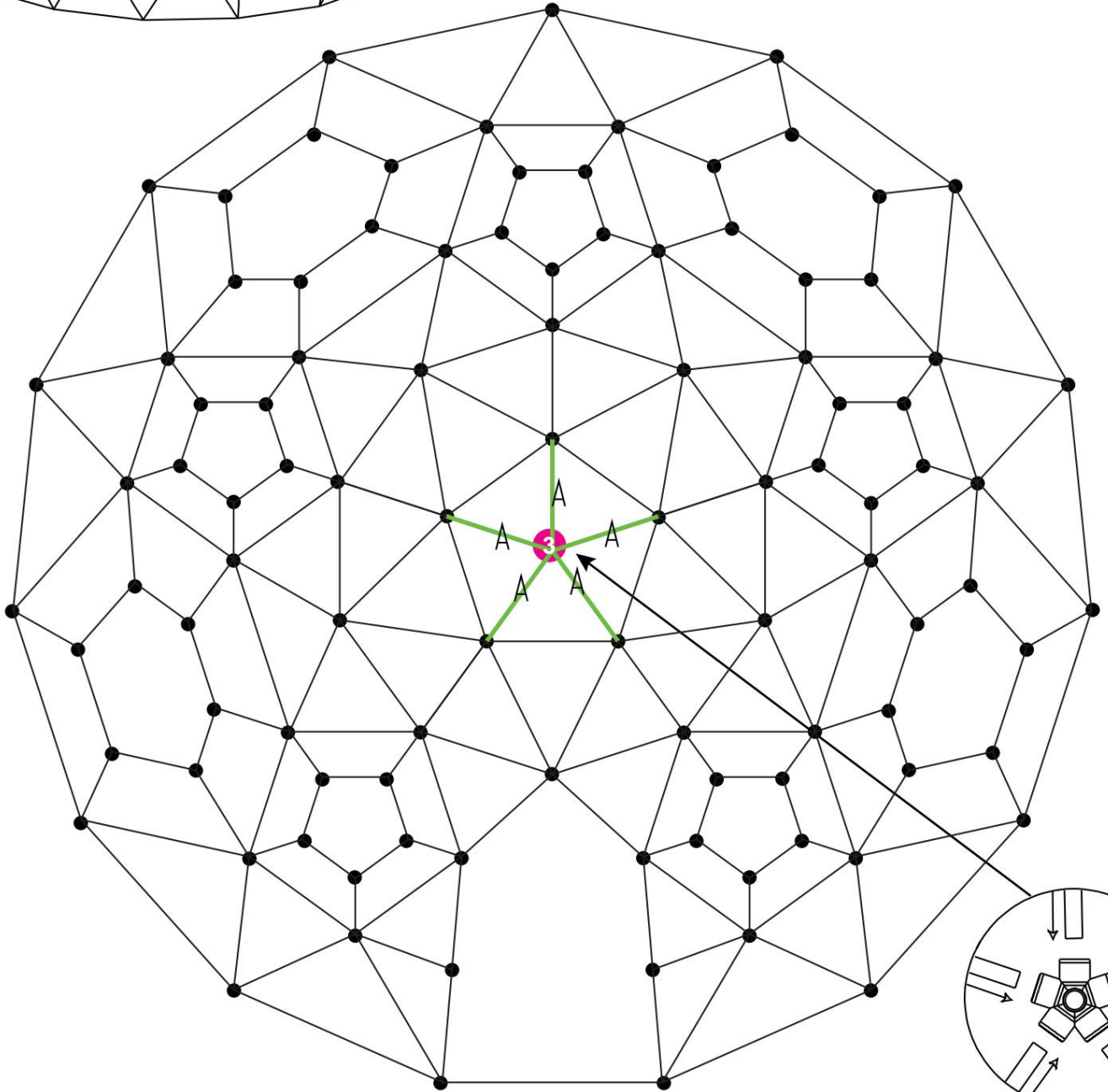
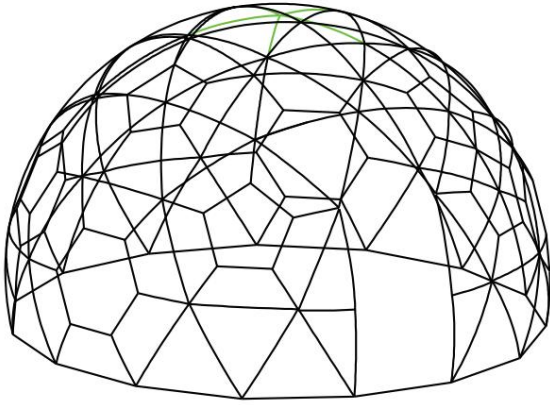

3x1

# Schritt-13

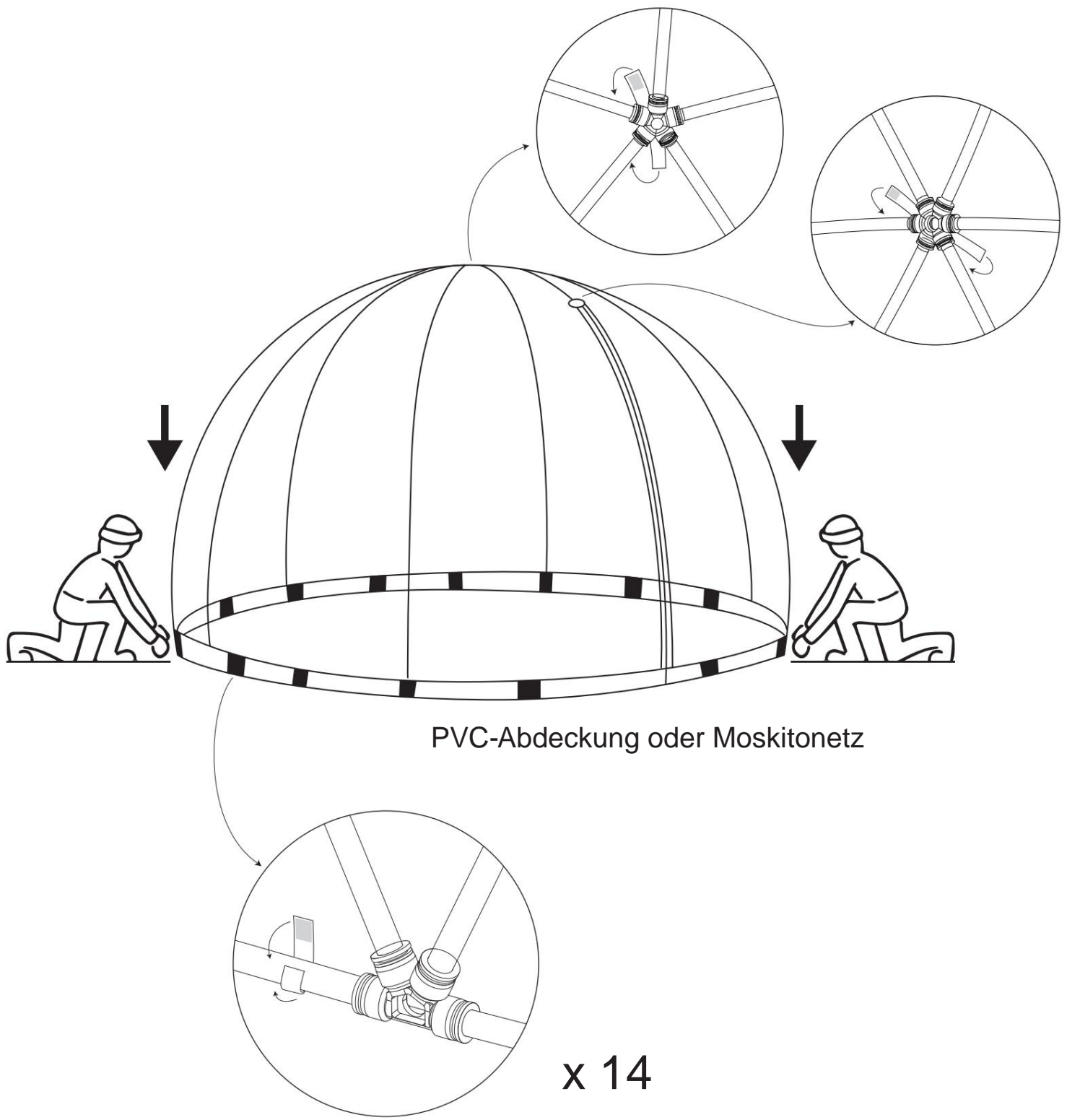

PVC-Abdeckung oder Moskitonetz

x 14



# Schritt-14

Option 1

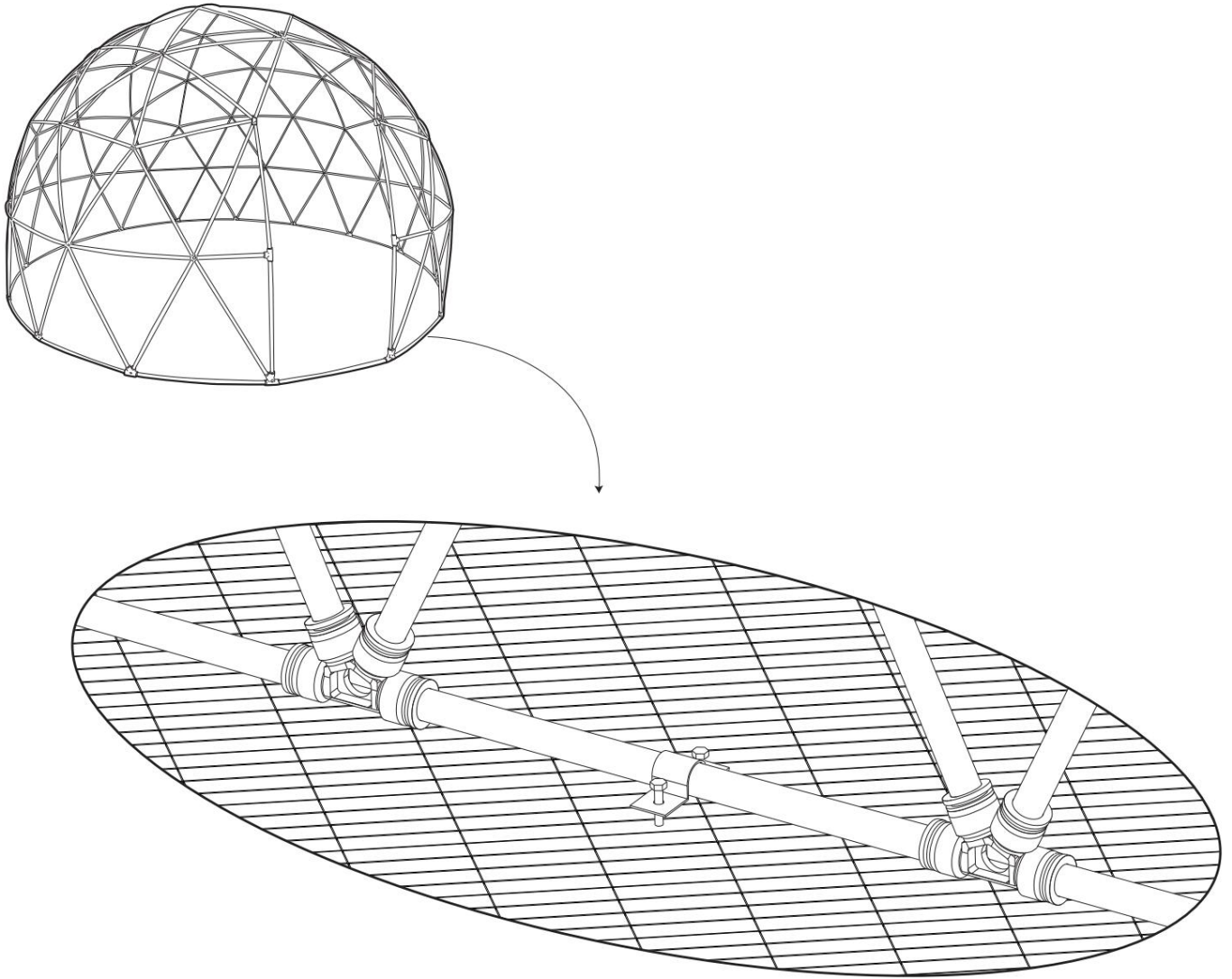

Auf dem Holz-/WPC-Boden installieren

# Schritt-15

Option 2

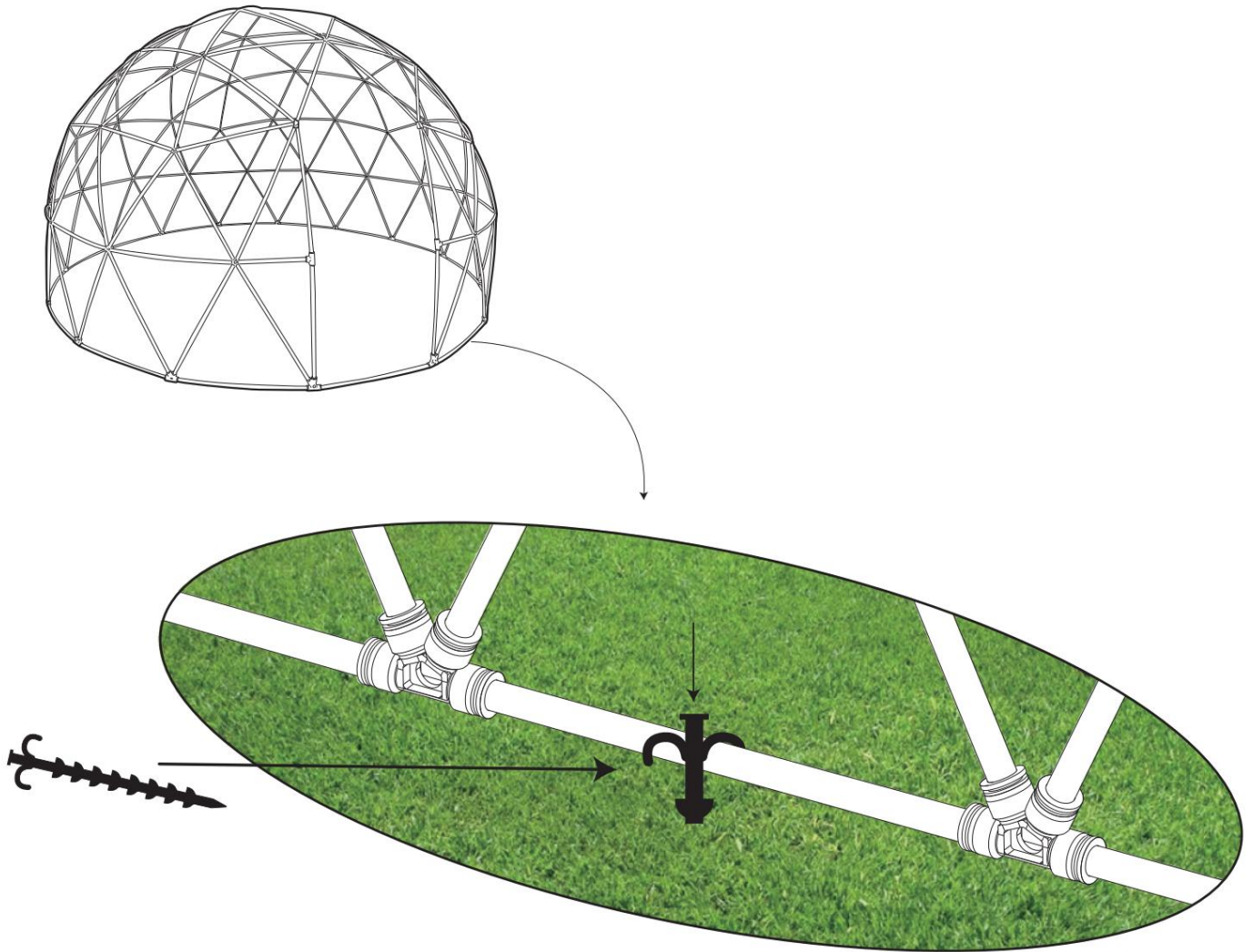

Auf dem Grasboden installieren

# Schritt-16

## Option 3: Sandsack

Achtung: Um Windschutz zu vermeiden  
ist ein Sandsack erforderlich, 14Stk

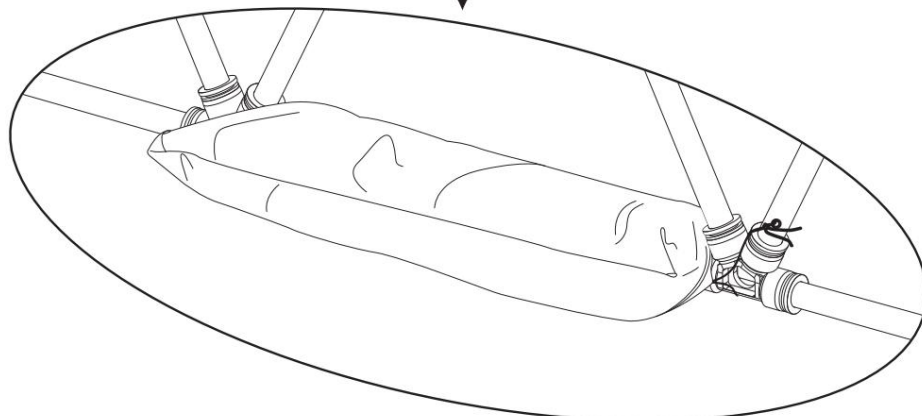
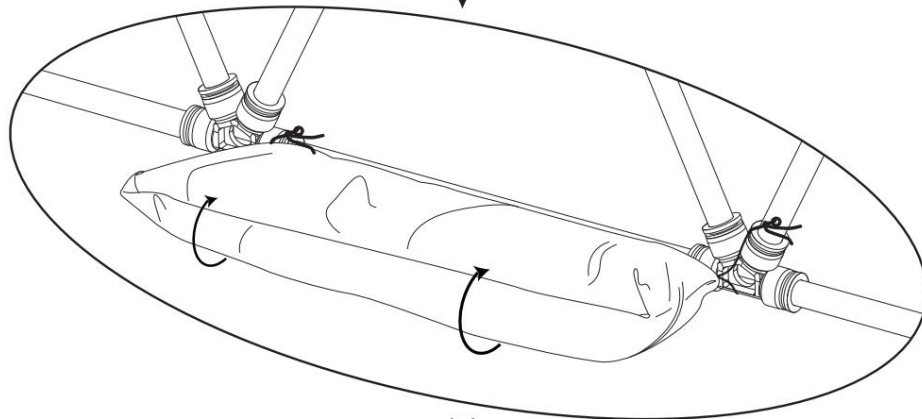
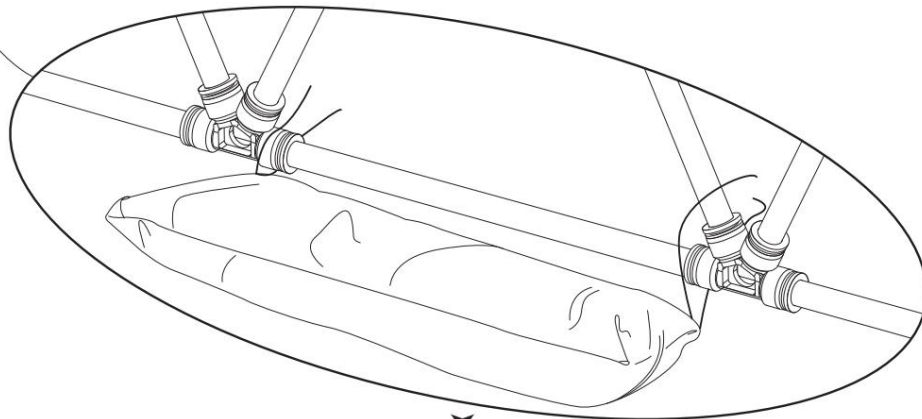
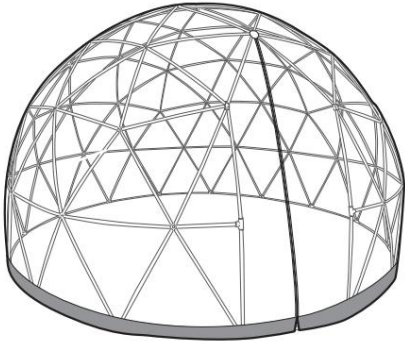

## Schritt-17

Tipps: Die PVC-Abdeckung wird nach der ersten Montage leichte Falten aufweisen. Ein Aufenthalt in der Sonne für etwa eine Stunde verbessert die Falten.

 **WARNUNG**

Halten Sie alle Flammen und Wärmequellen  
WEG VON DIESEM KUPPELSTOFF

**Manufacturer:**Shanghaimuxinmuyeyouxiangongsi

**Address:** Shuangchenglu 803nong11hao1602A-1609shi, baoshanqu, shanghai 200000 CN.

**Imported to AUS:** SIHAO PTY LTD. 1 ROKEVA STREETEASTWOOD NSW 2122 Australia

**Imported to USA:** Sanven Technology Ltd. Suite 250, 9166 Anaheim Place, Rancho Cucamonga, CA 91730



E-CrossStu GmbH  
Mainzer Landstr.69, 60329 Frankfurt am Main.



YH CONSULTING LIMITED.  
C/O YH Consulting Limited Office 147, Centurion House,  
London Road, Staines-upon-Thames, Surrey, TW18 4AX



**VEVOR**<sup>®</sup>

**TOUGH TOOLS, HALF PRICE**

Technical Support and E-Warranty Certificate

[www.vevor.com/support](http://www.vevor.com/support)

# VEVOR<sup>®</sup>

## TOUGH TOOLS, HALF PRICE

Technical Support and E-Warranty Certificate [www.vevor.com/support](http://www.vevor.com/support)

### JARDIN EXTÉRIEUR CLAIR DOOM

#### MANUEL DE L'UTILISATEUR

Nous continuons à nous engager à vous fournir des outils à des prix compétitifs. "Économisez la moitié", "Moitié prix" ou toute autre expression similaire que nous utilisons ne représente qu'une estimation des économies dont vous pourriez bénéficier en achetant certains outils chez nous par rapport aux grandes marques et ne signifie pas nécessairement couvrir toutes les catégories d'outils proposés. par nous. Nous vous rappelons de vérifier attentivement lorsque vous passez une commande chez nous si vous économisez réellement la moitié par rapport aux grandes marques.

**VEVOR**<sup>®</sup>  
TOUGH TOOLS, HALF PRICE

JARDIN EXTERIEUR CLAIR  
PERTE

Model: GB-DOME-12, GB-DOME-12T, GB-DOME-9.5 GB-DOME-9.5T

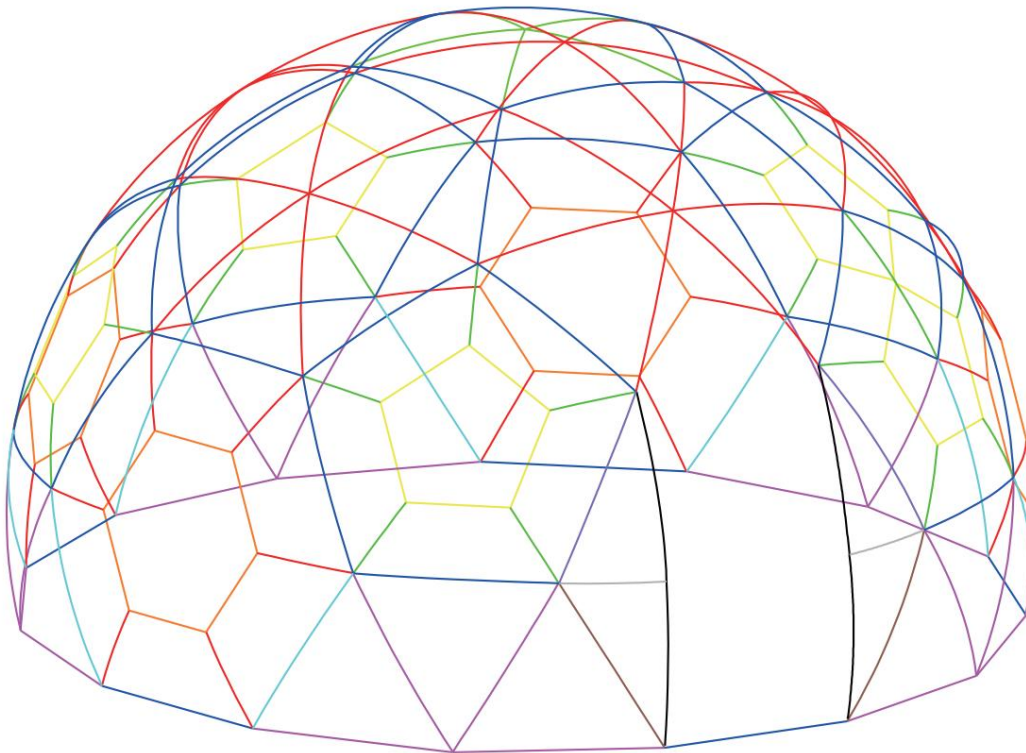

**BESOIN D'AIDE? CONTACTEZ-NOUS!**

Vous avez des questions sur les produits ? Besoin d'une assistance technique ? N'hésitez pas à nous contacter :  
Support technique et certificat de garantie électronique [www.vevor.com/support](http://www.vevor.com/support)

Il s'agit des instructions originales, veuillez lire attentivement toutes les instructions du manuel avant de l'utiliser.  
VEVOR se réserve une interprétation claire de notre manuel d'utilisation. L'apparence du produit dépend du produit  
que vous avez reçu. Veuillez nous pardonner que nous ne vous informerons plus s'il y a des mises à jour technologiques  
ou logicielles sur notre produit.

## CARACTÉRISTIQUES

Modèle	GB-DÔME-12
Taille du produit	12 pieds
Couleur	Transparent
Capacité de chargement	110 livres

Modèle	GB-DÔME-12T
Taille du produit	12 pieds
Couleur	Transparent
Capacité de chargement	110 livres

Modèle	GB-DÔME-9.5
Taille du produit	9,5 pieds
Couleur	Transparent
Capacité de chargement	110 livres







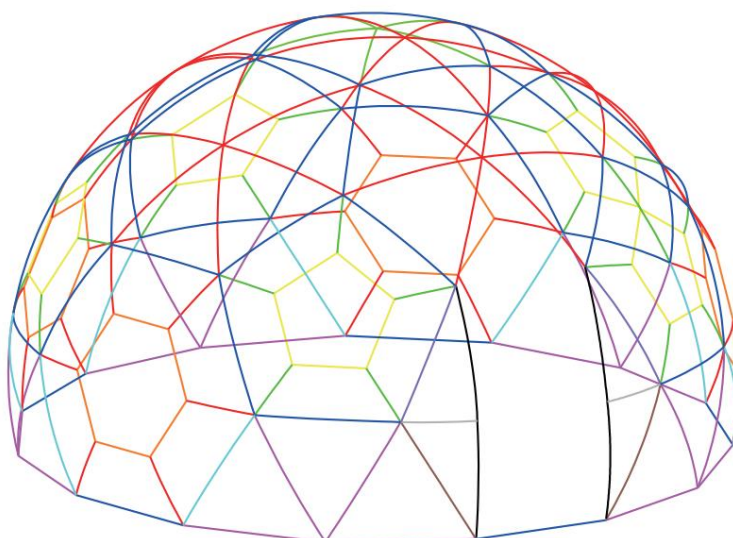

Modèle	GB-DÔME-9.5T
Taille du produit	9,5 pieds
Couleur	Transparent
Capacité de chargement	110 livres

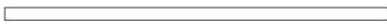
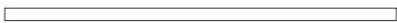
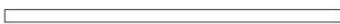
# Accessoires

Modèle	Couverture transparente en PVC	Couverture anti-moustique
GB-DÔME-12	✓	✗
GB-DÔME-12T	✓	✓
GB-DÔME-9.5	✓	✗
GB-DÔME-9.5T	✓	✓

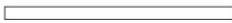

## Tuyaux :

- UN  5 pièces
- B  42 pièces
- C  50 pièces
- D  4 pièces
- E  8 pièces
- g  2 pièces
- H  2 pièces
-  2 pièces
- J.  25 pièces
- K  25 pièces
- L  24 pièces
- M.  24 pièces

## Couverture:

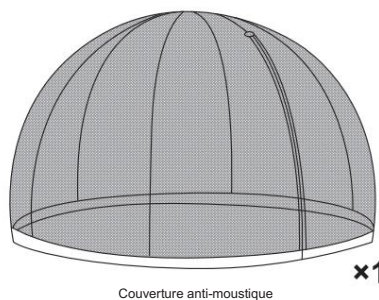
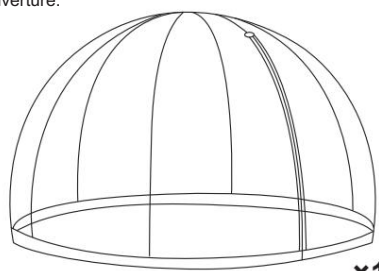

## Évaluations standards :

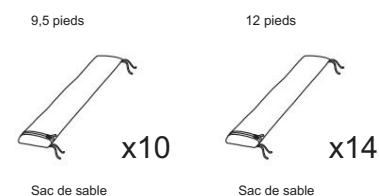

## Connecteurs :

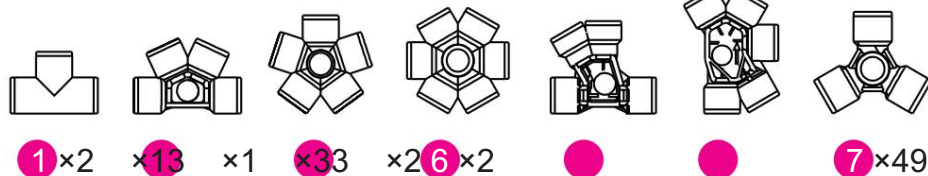

# Étape 01

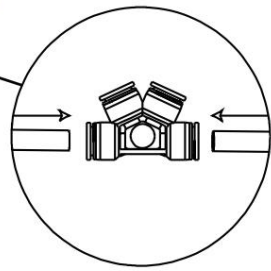
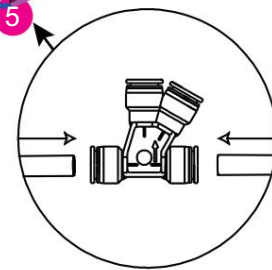
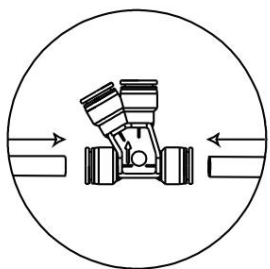
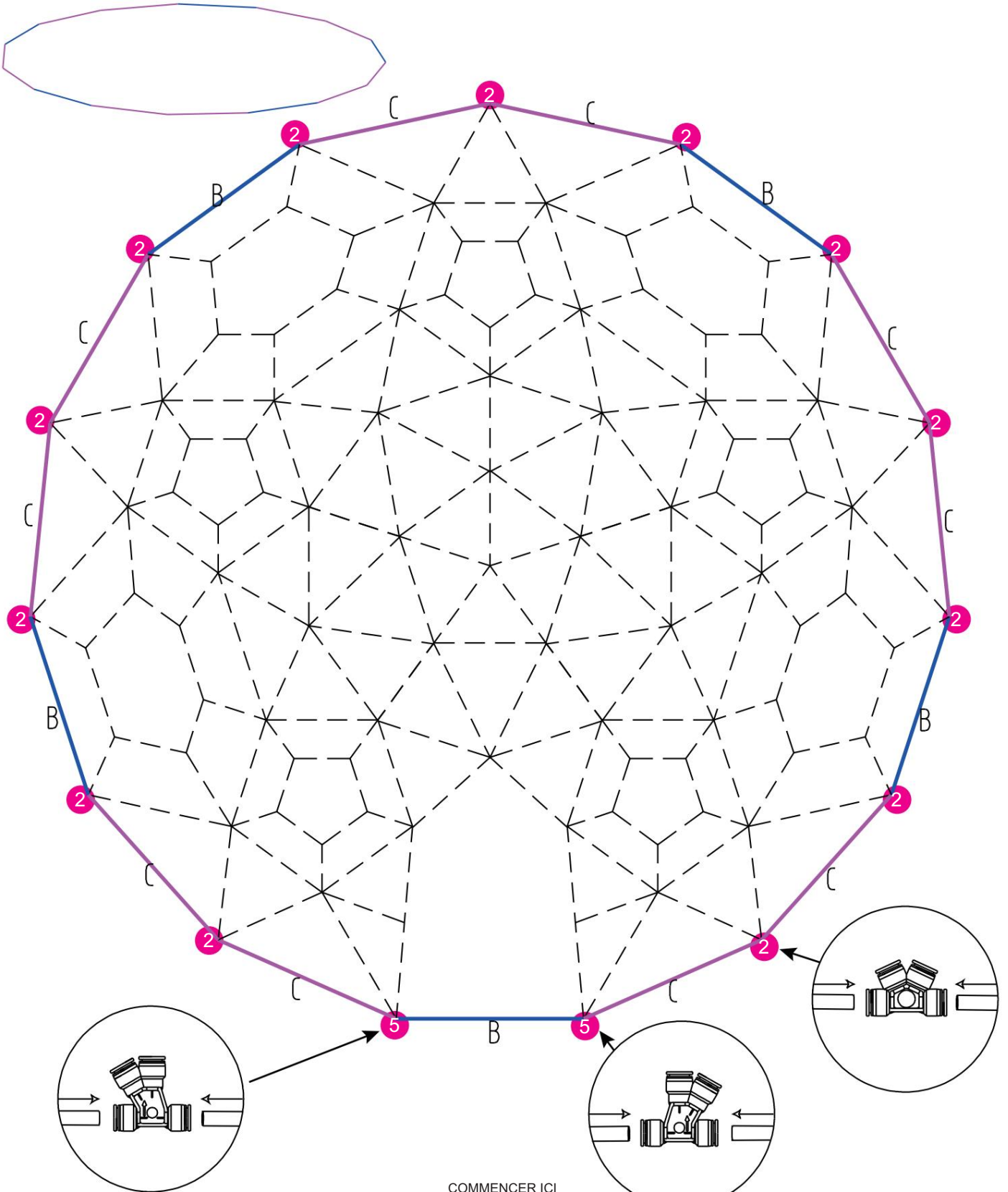

COMMENCER ICI

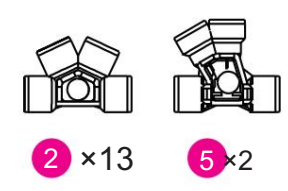
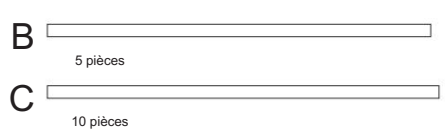
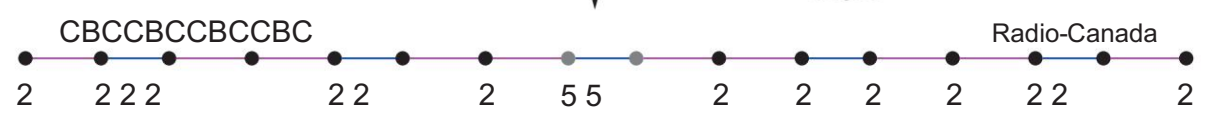

# Étape 02

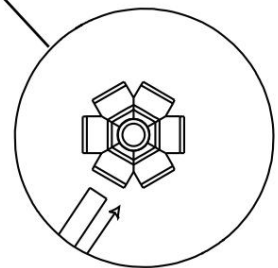
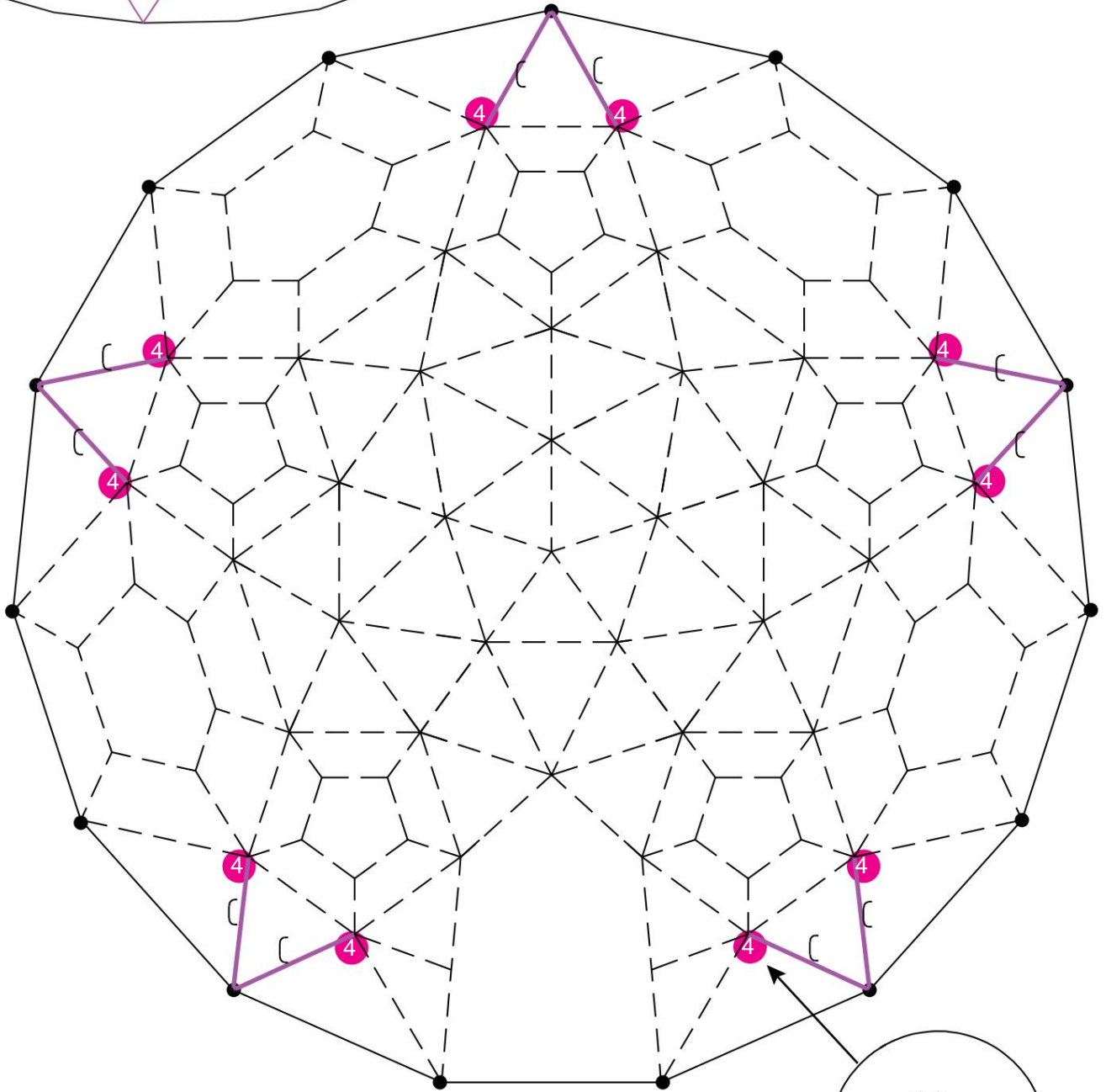
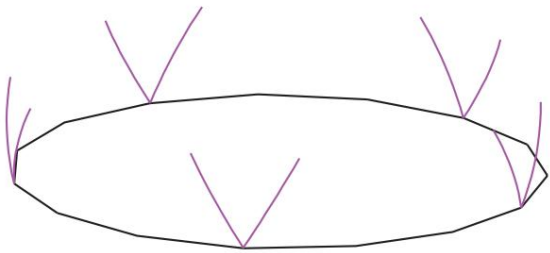

C   
10 pièces

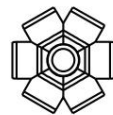

4 × 10

# Étape 03

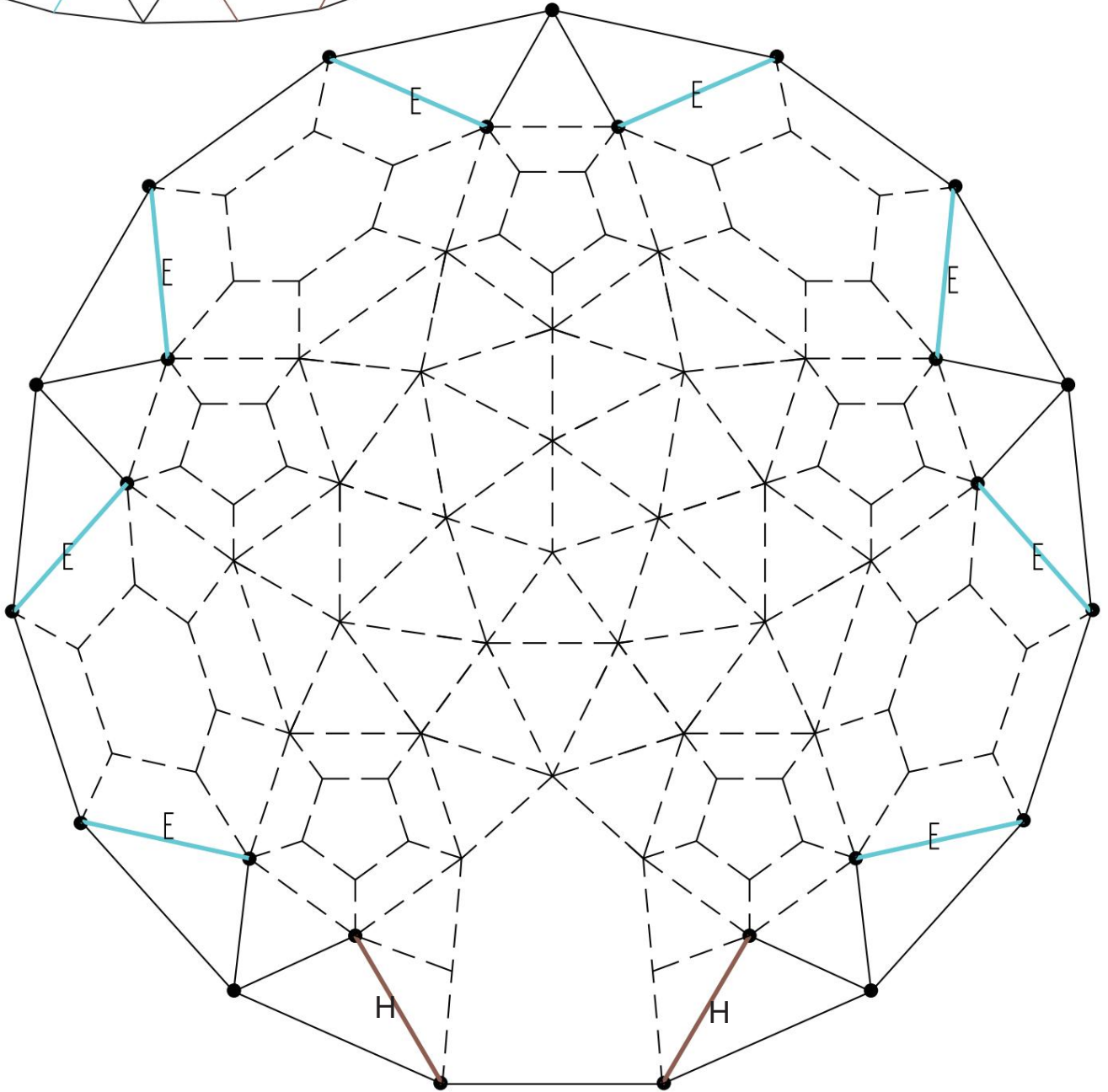
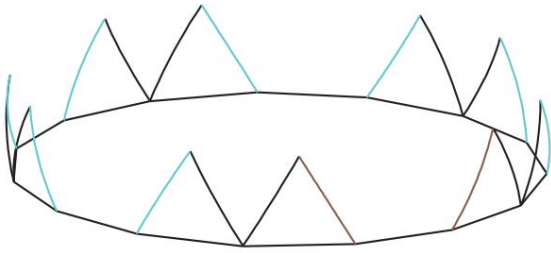

E   
8 pièces

H   
2 pièces

# Étape 04

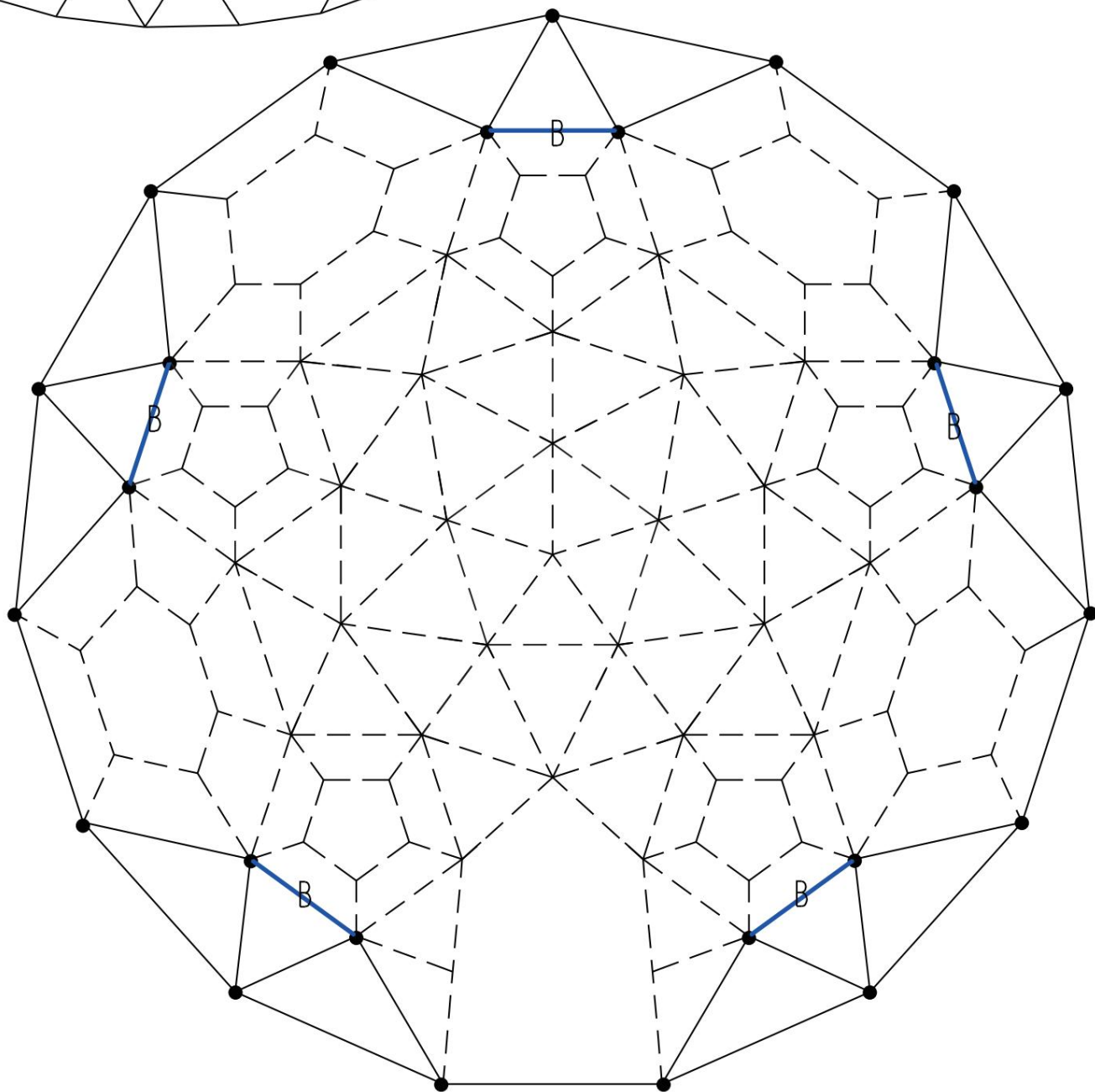
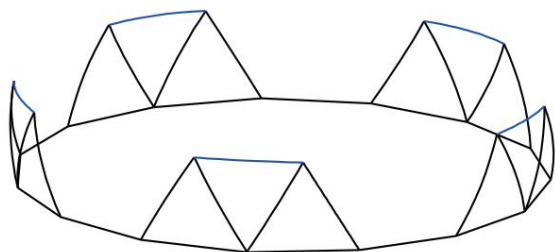

B 

5 pièces

# Étape 05

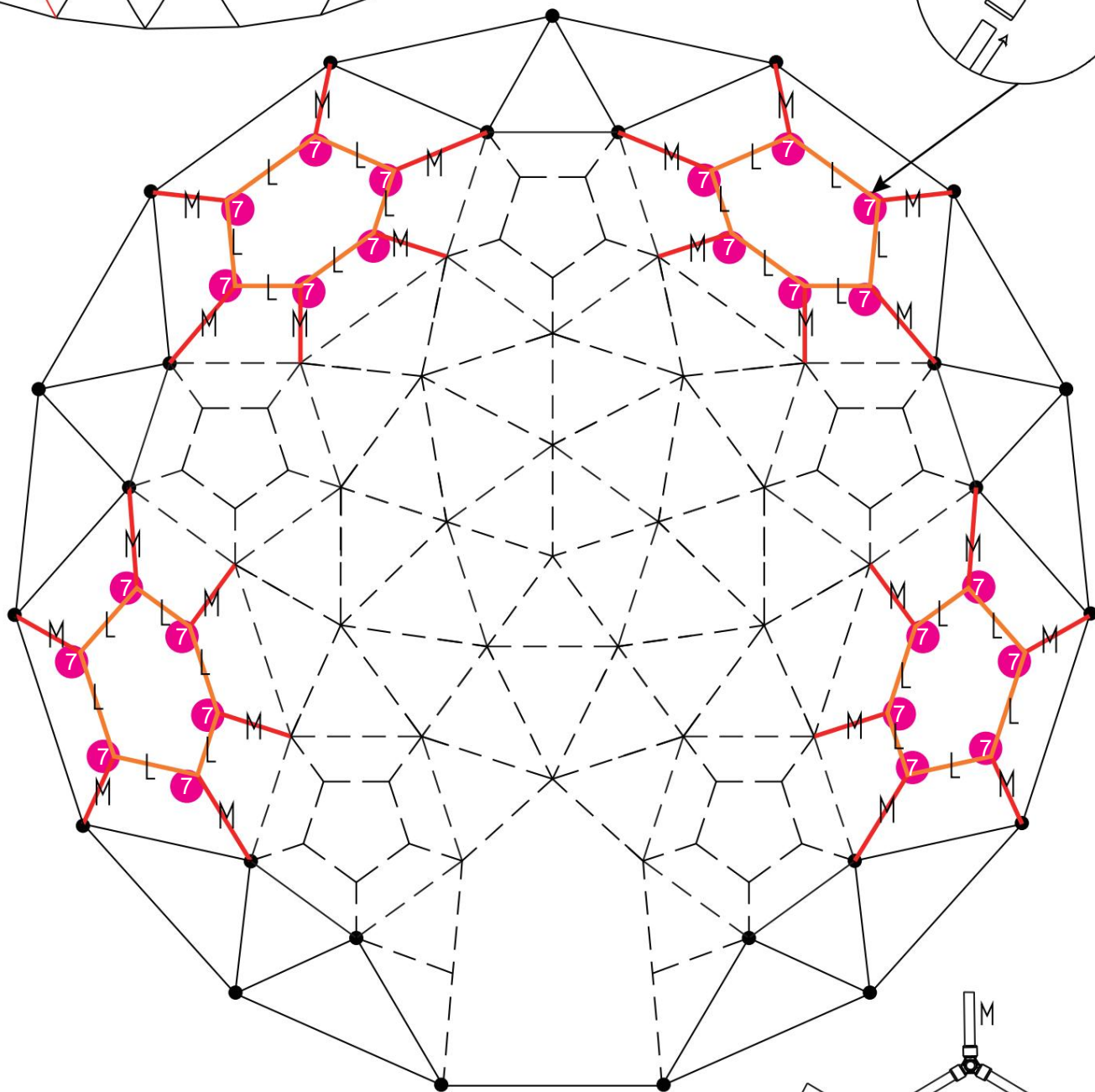
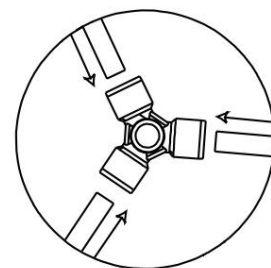
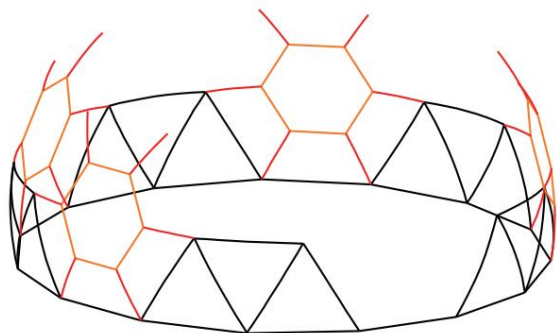

L  24 pièces

M.  24 pièces



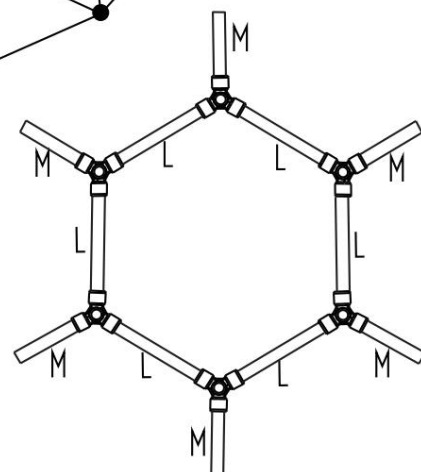

7 x 24

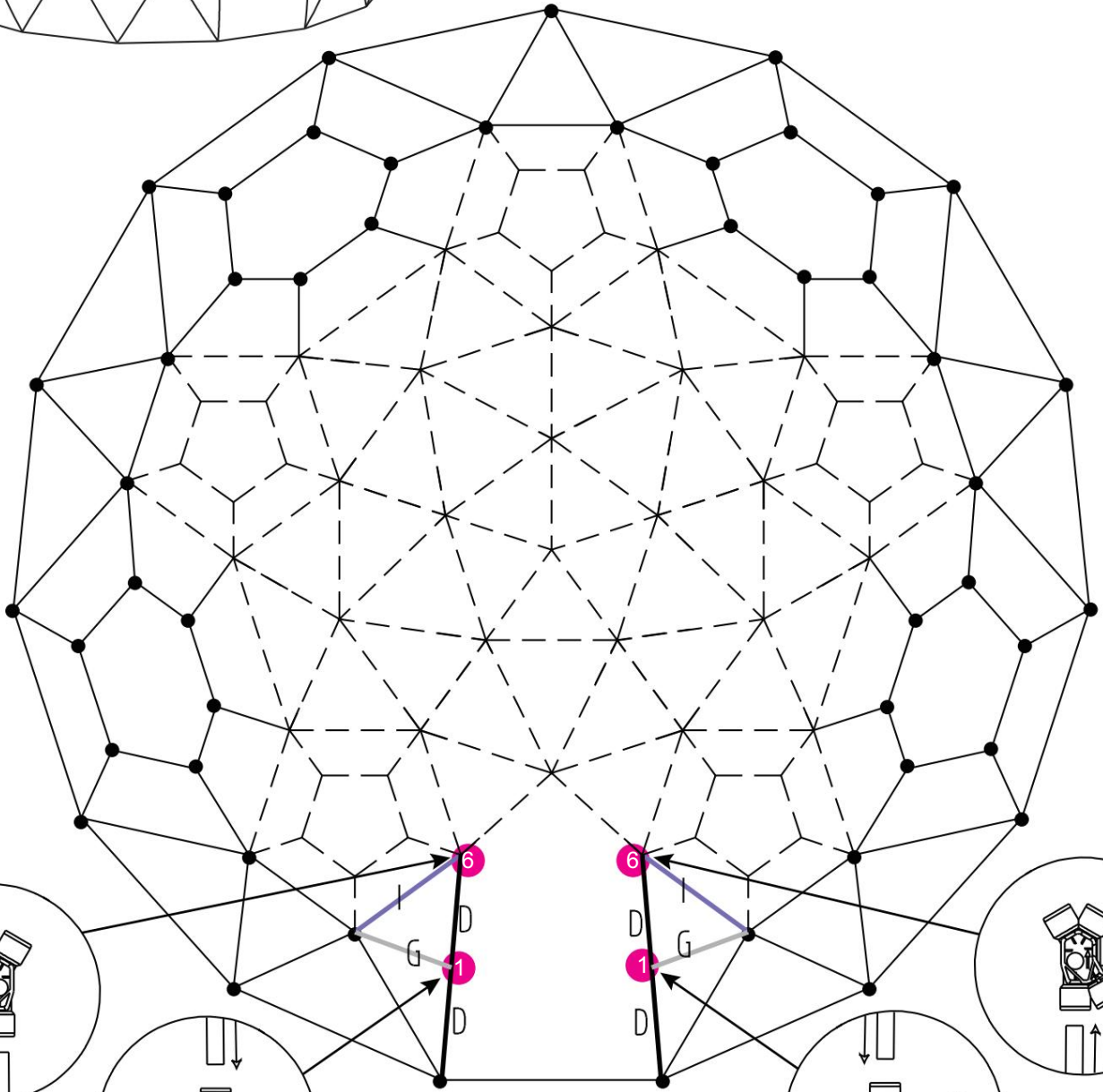
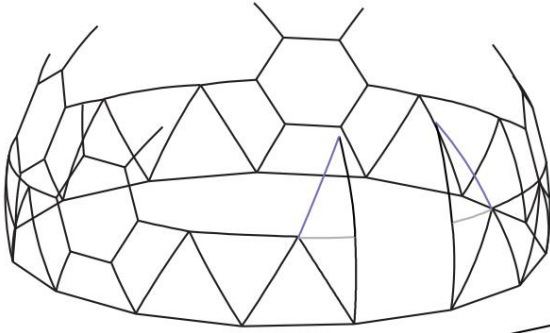

# Étape 06



D   
4 pièces

g   
2 pièces

  
2 pièces

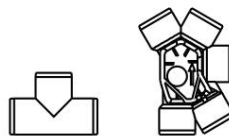

1 x 2    2 x 2



# Étape 07

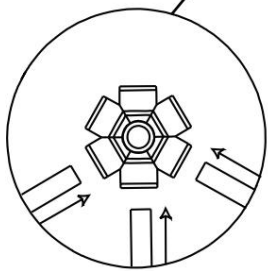
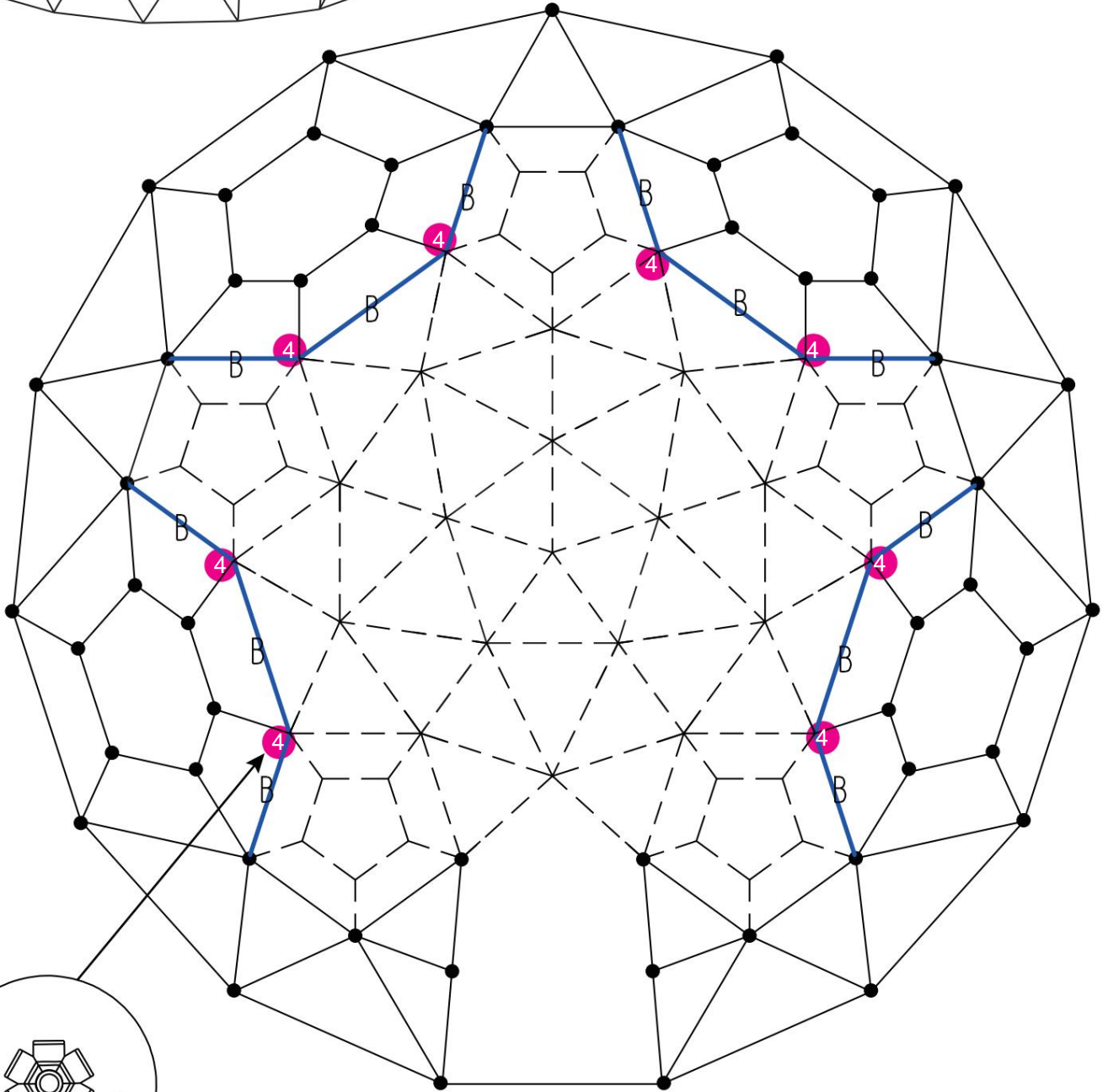
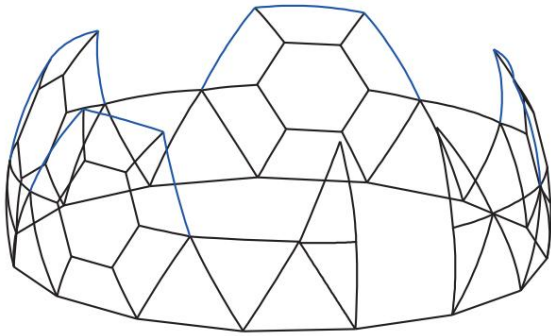

B   
12 pièces



4 × 8

# Étape 08

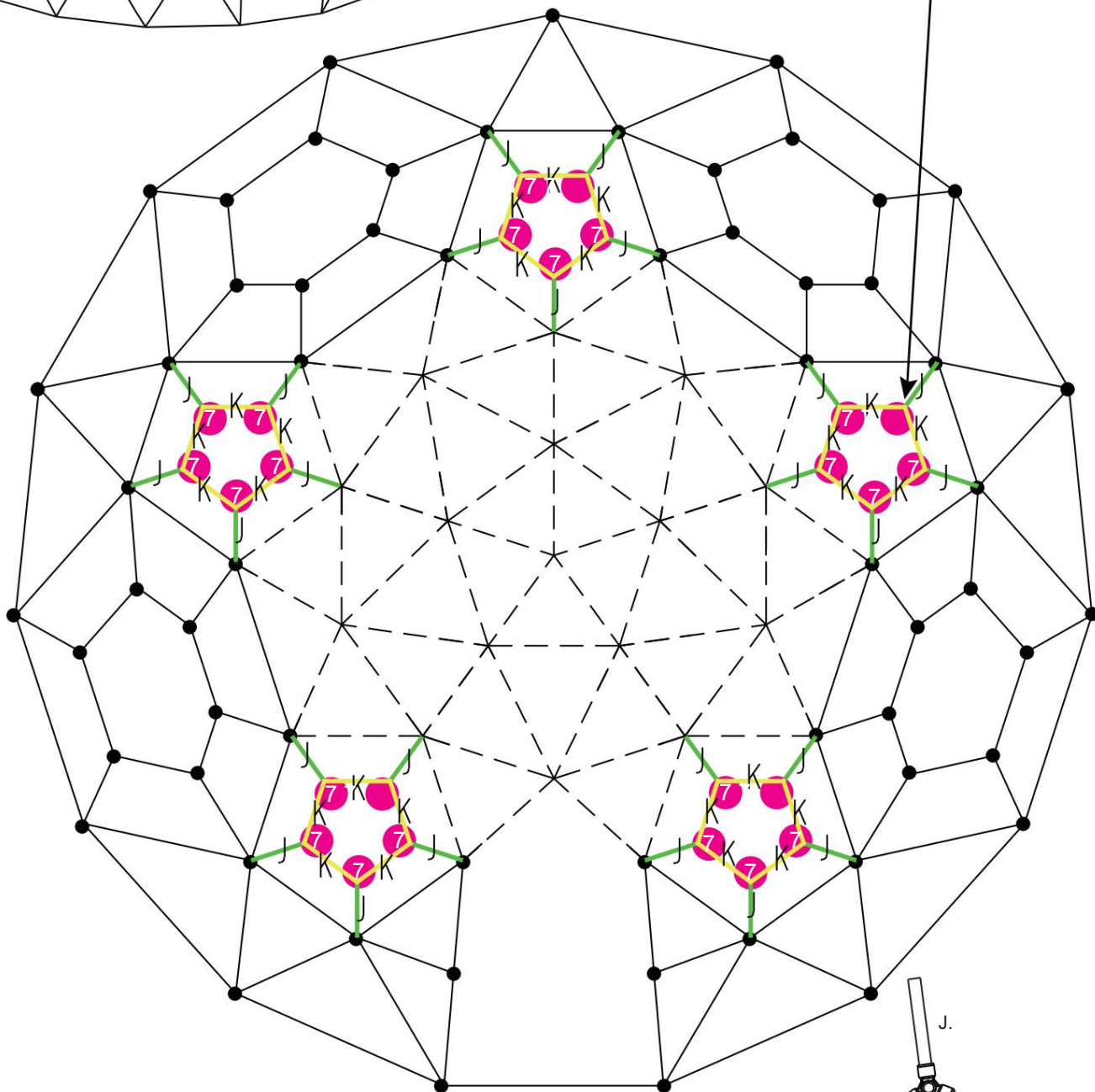
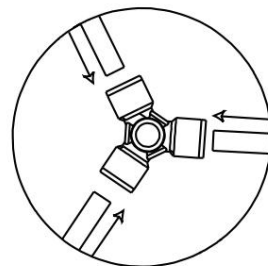
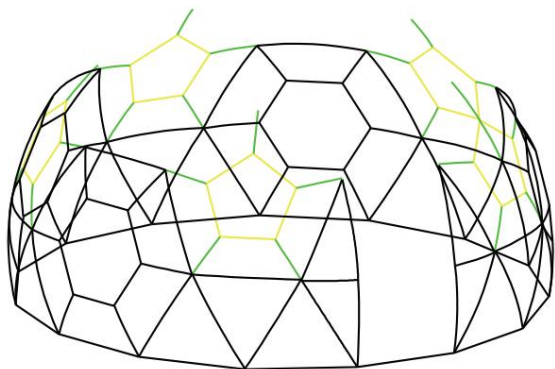

J.  25 pièces

K.  25 pièces



 x25

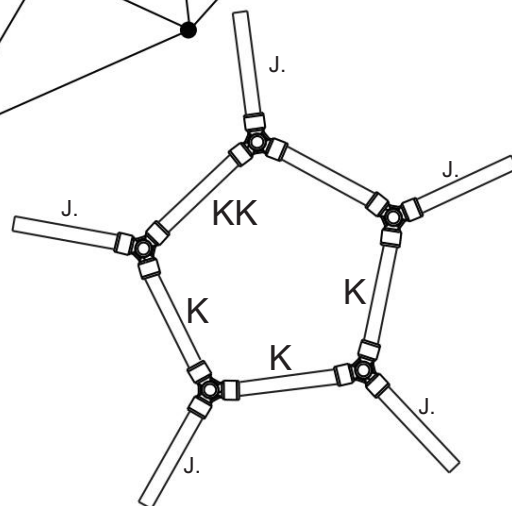

# Étape 09

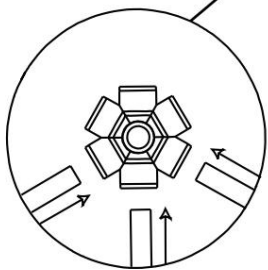
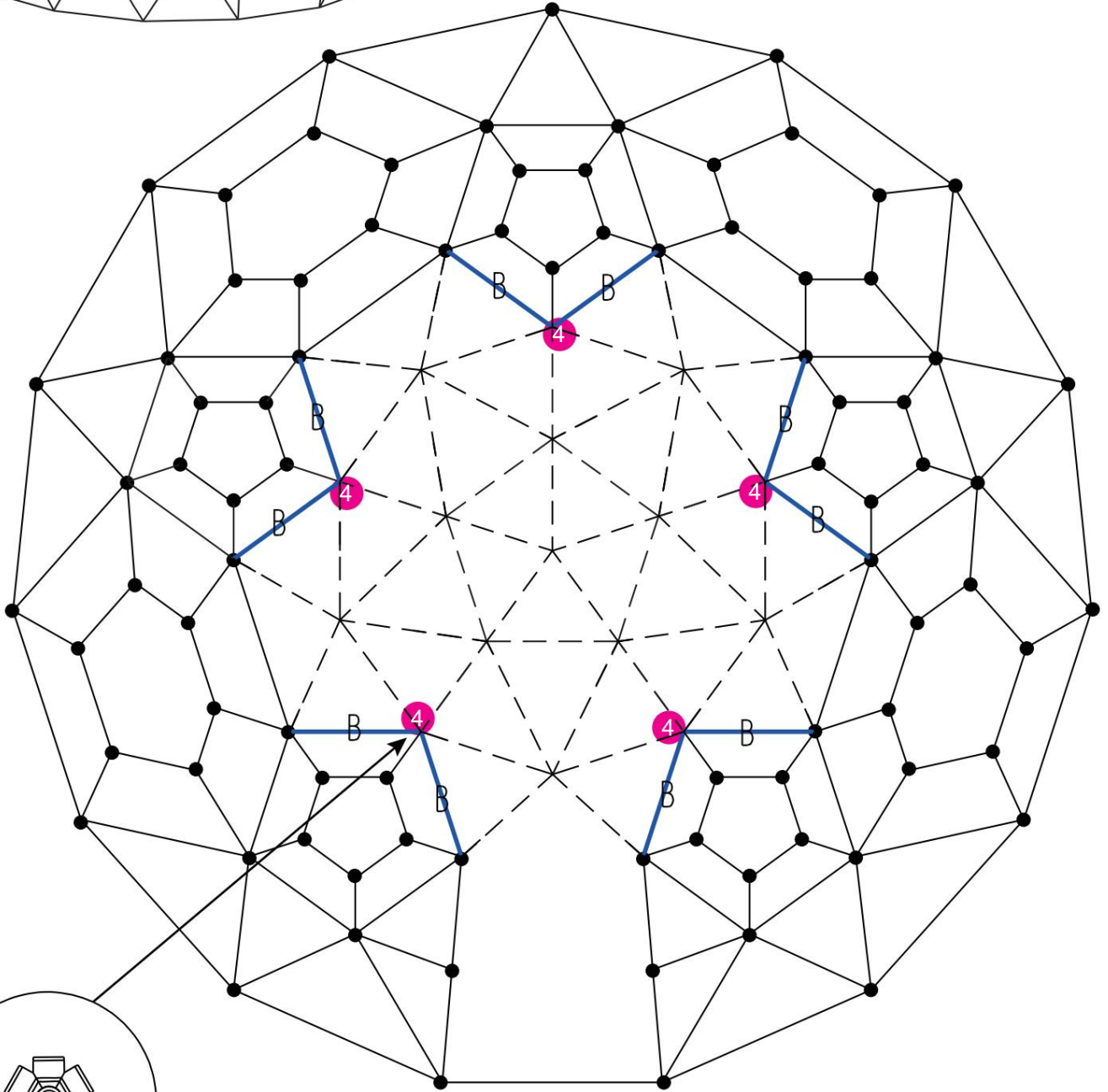
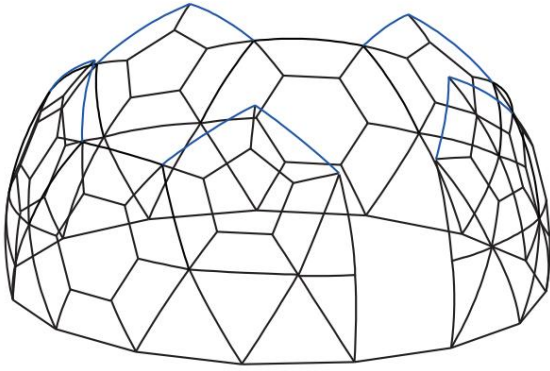

B   
10 pièces



4 x5

# Étape 10

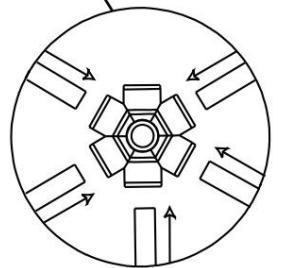
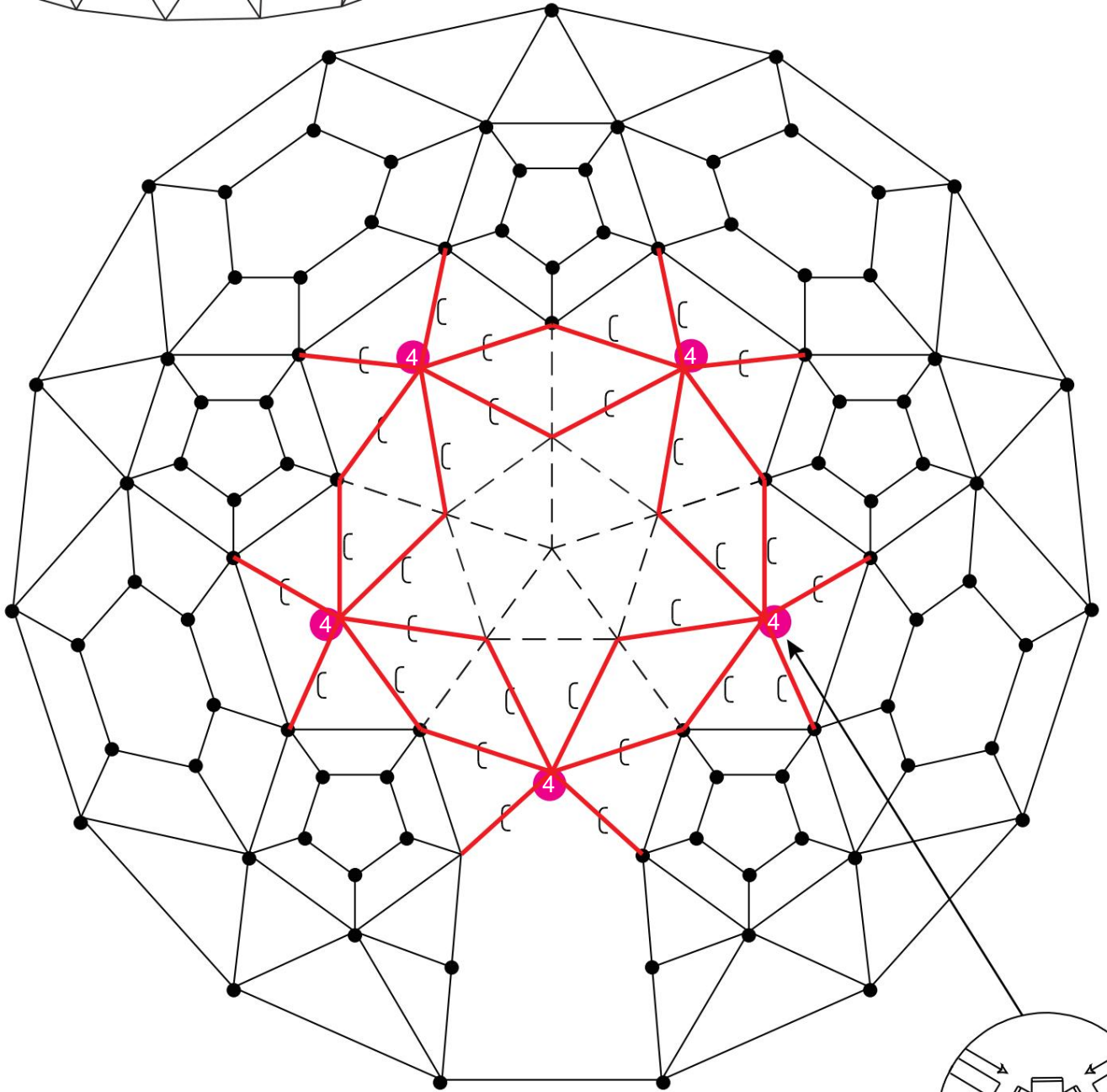
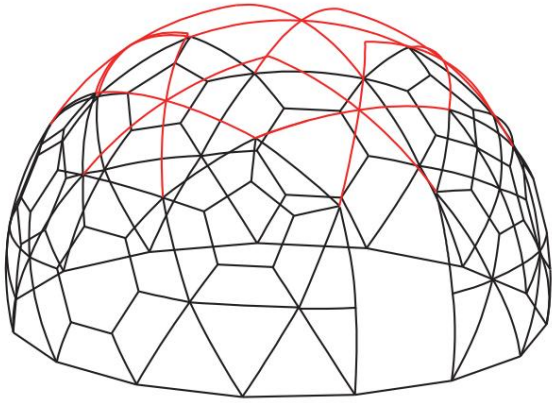

C   
71 cm / 30 pièces

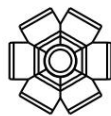

4 x5

# Étape 11

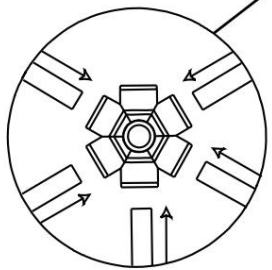
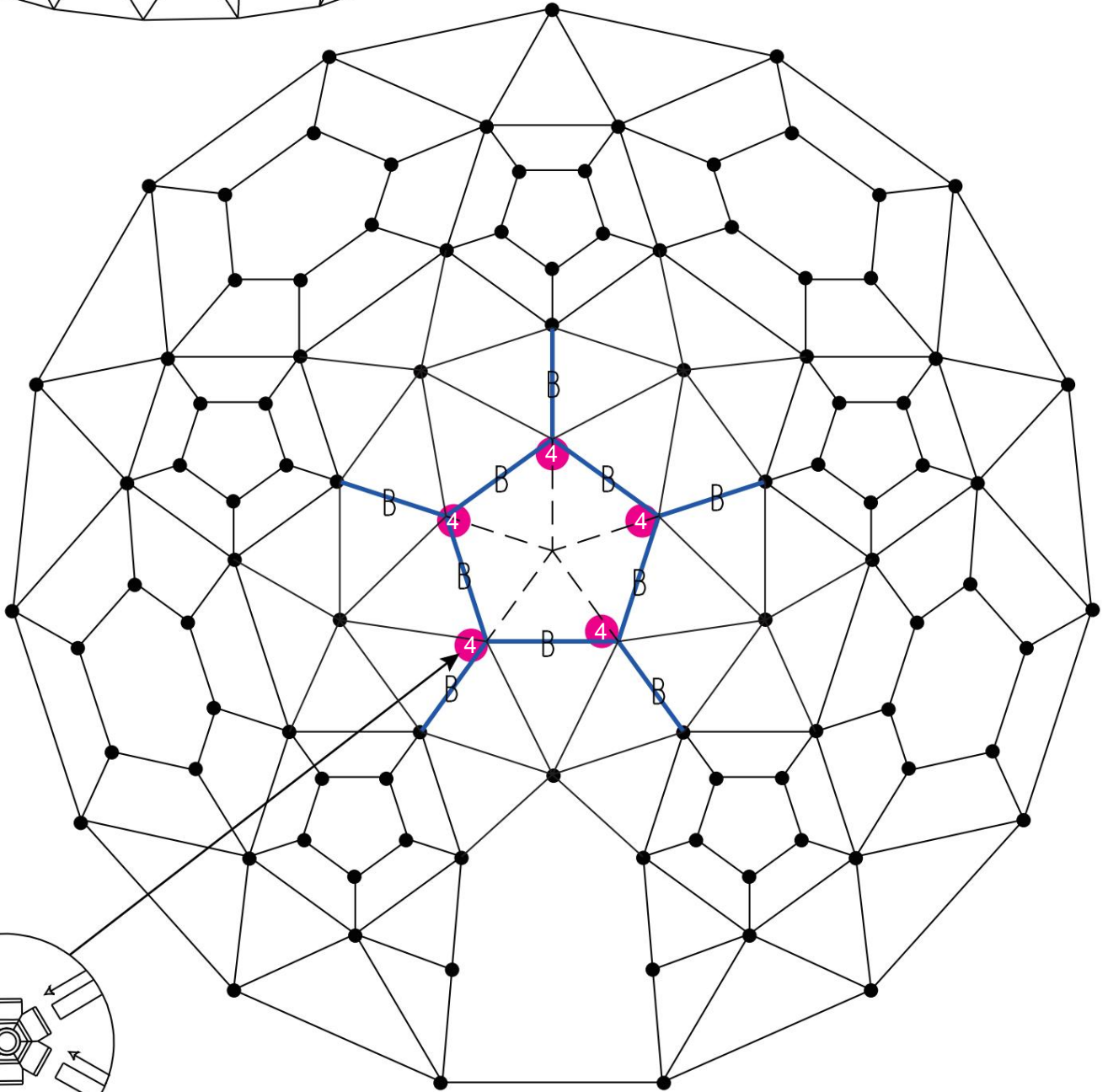
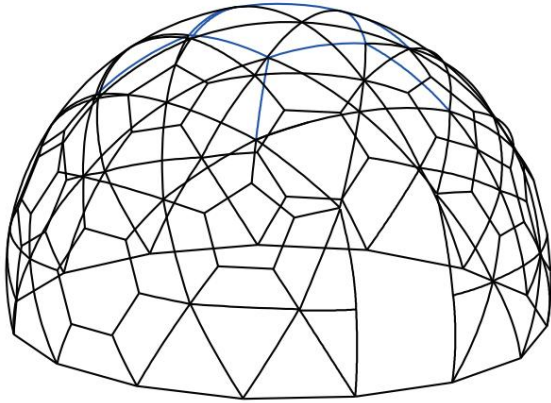

B   
10 pièces

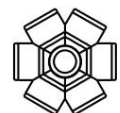

4 × 5



# Étape 12

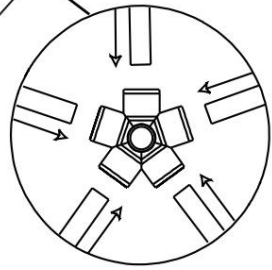
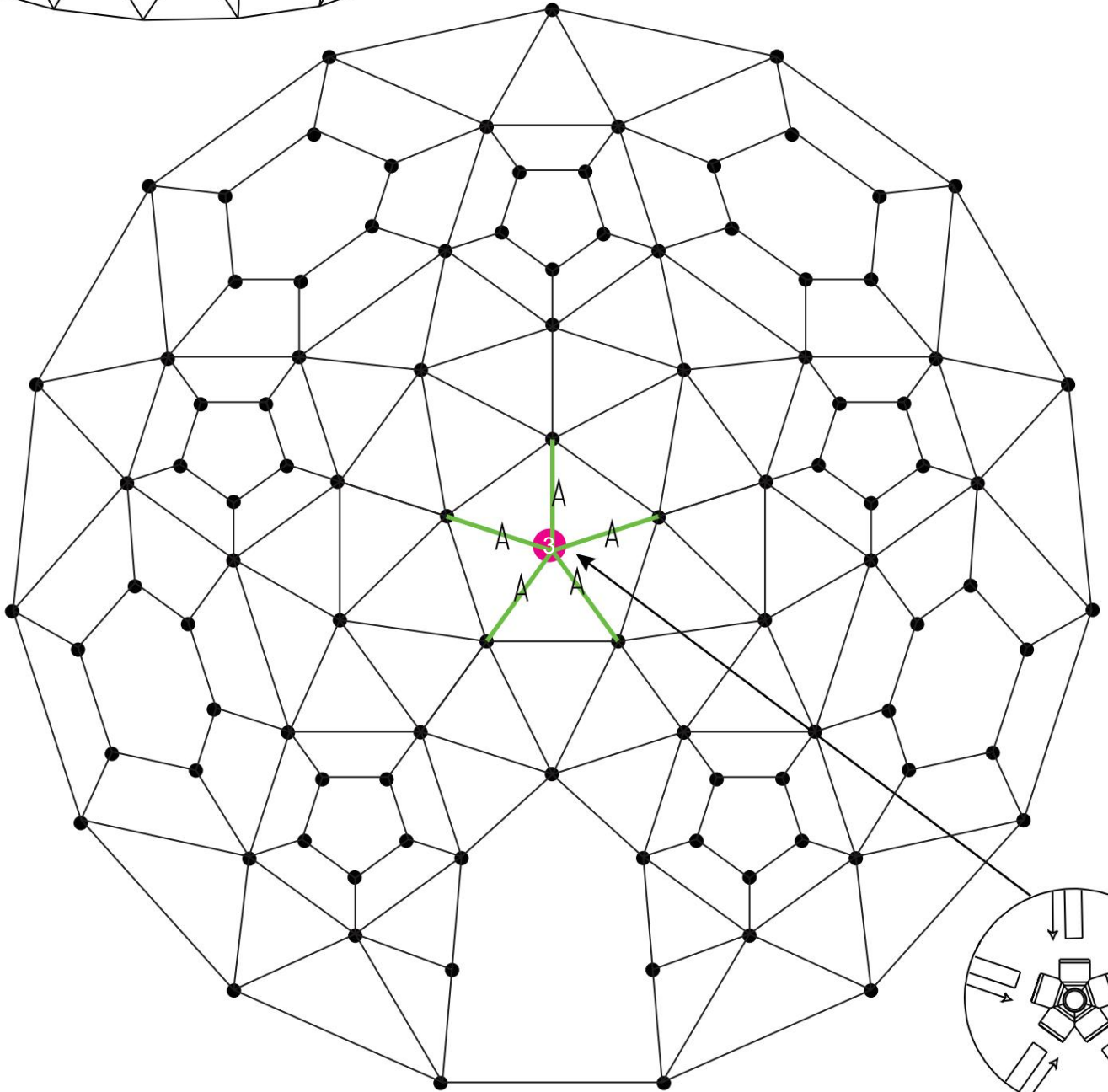
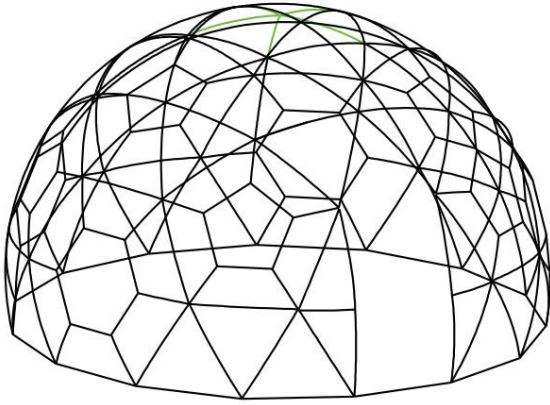

UN   
5 pièces

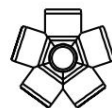

3 x 1

# Étape 13

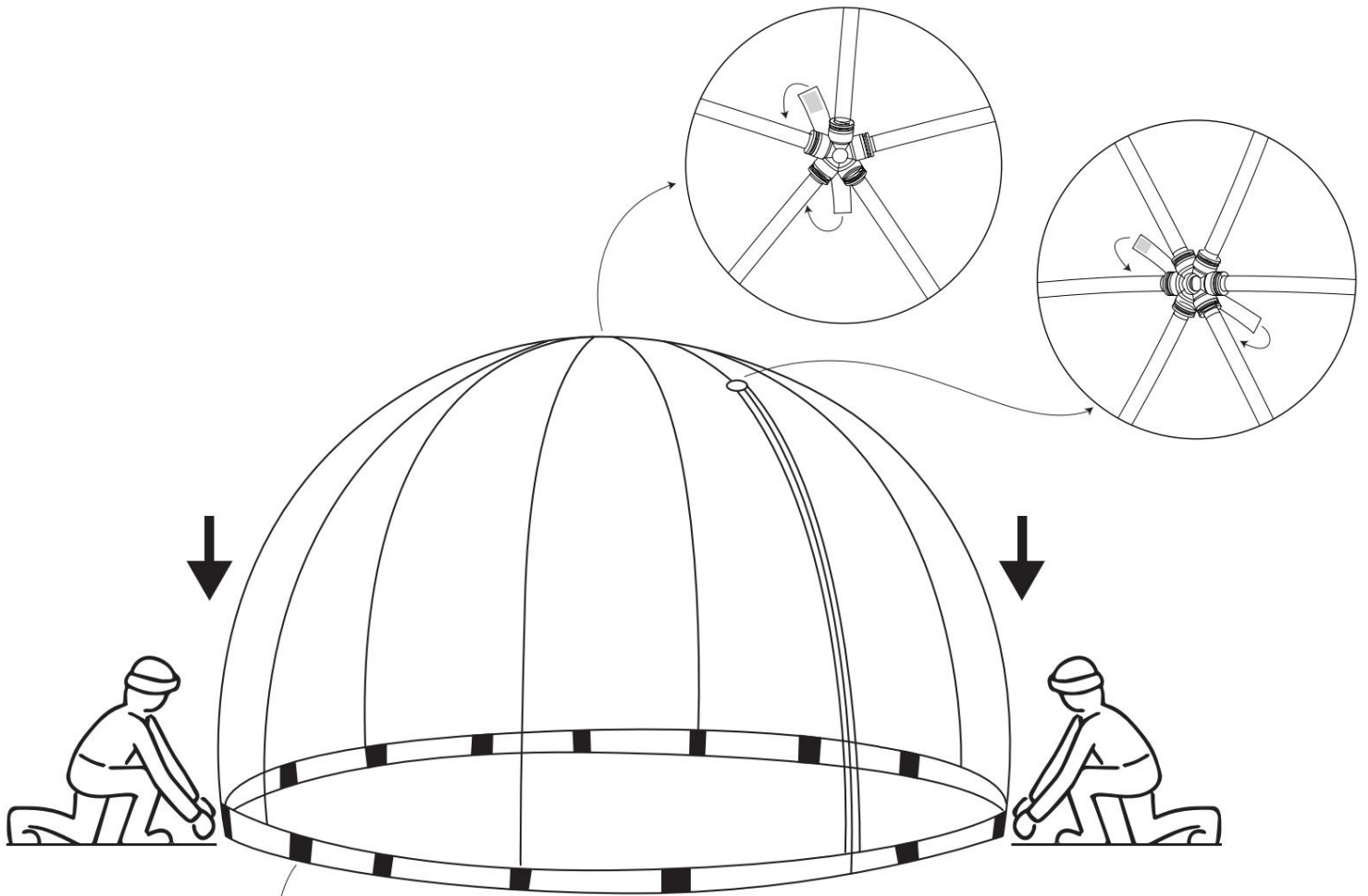

housse en pvc ou housse anti-moustique

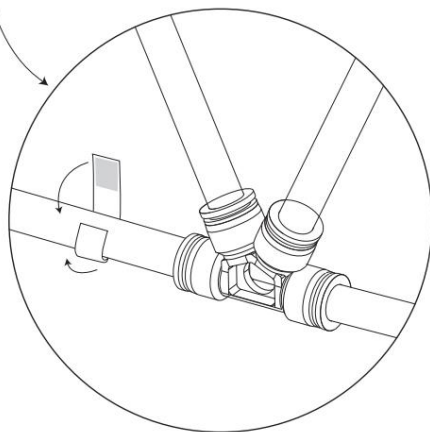

x14



# Étape 14

## Option 1

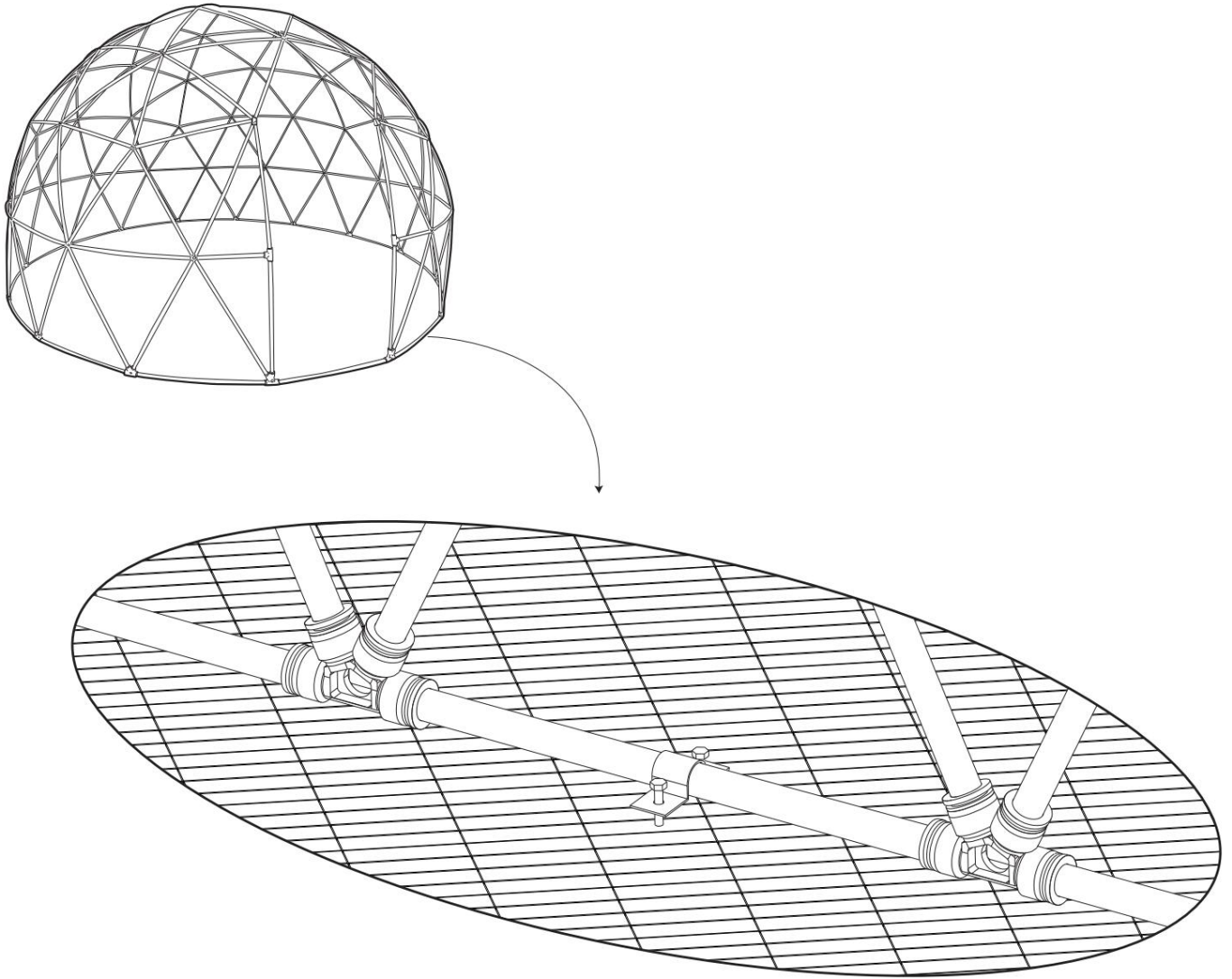

Installer sur le plancher en bois/wpc

# Étape 15

## Option 2

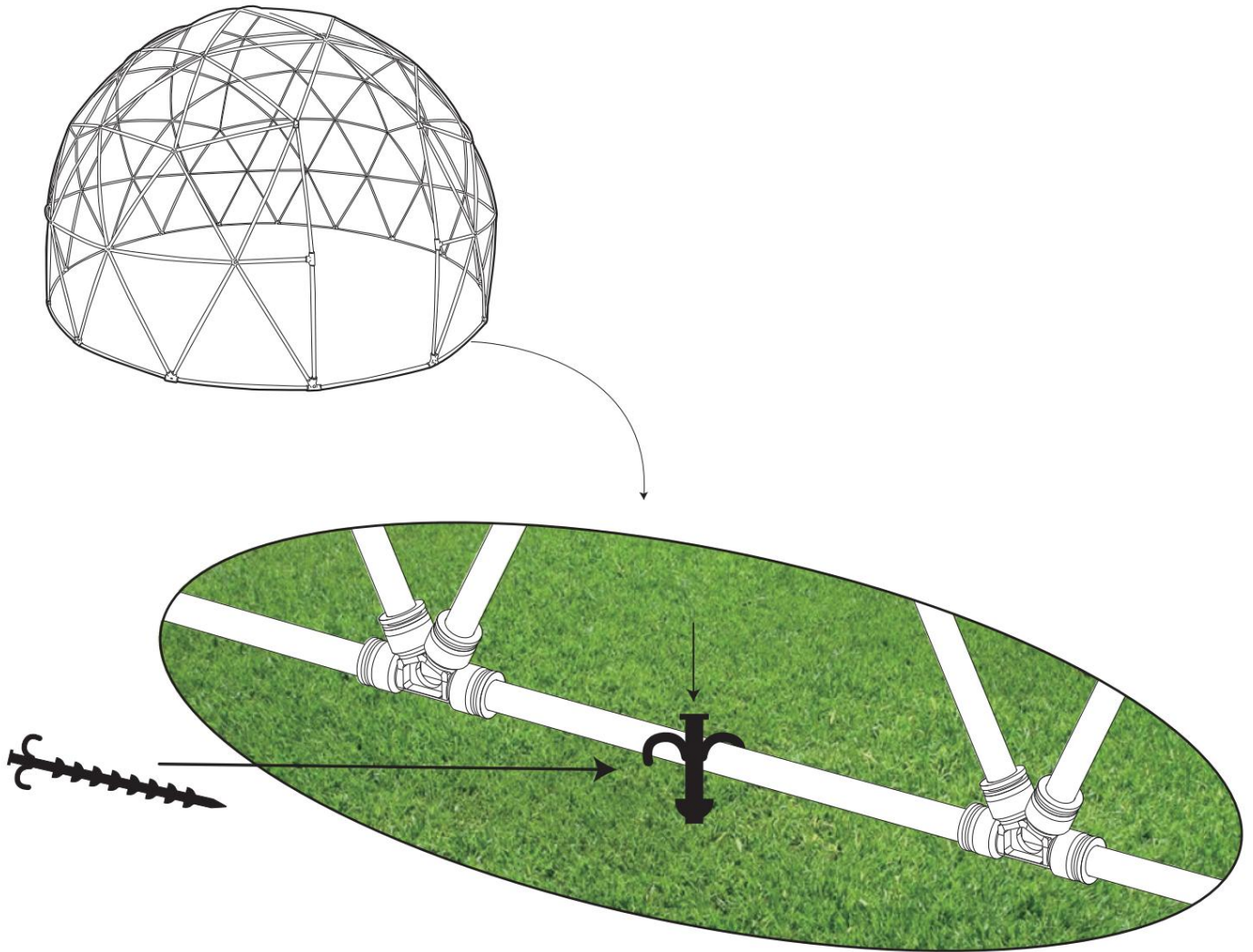

Installer sur le sol en herbe

# Étape 16

## Option 3 : sac de sable

Attention : pour éviter le vent, un sac de sable est nécessaire, 14 pièces.

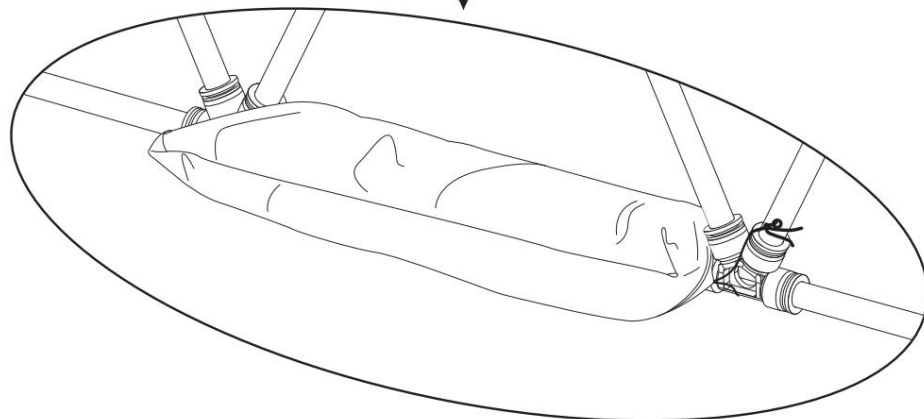
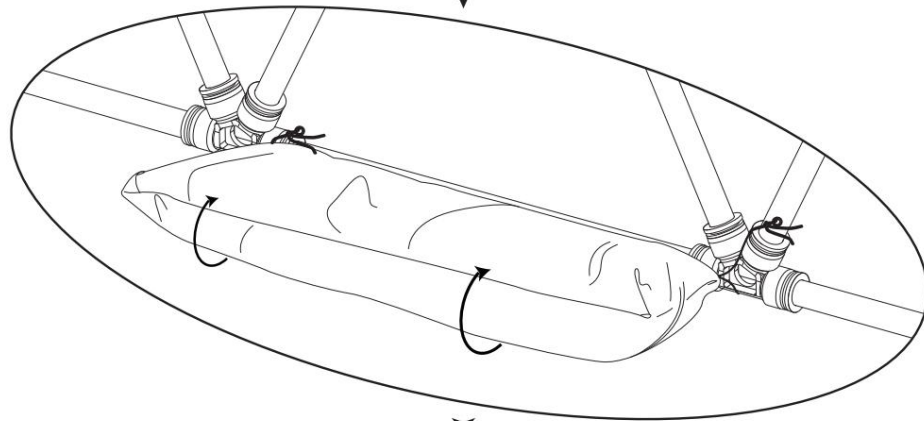
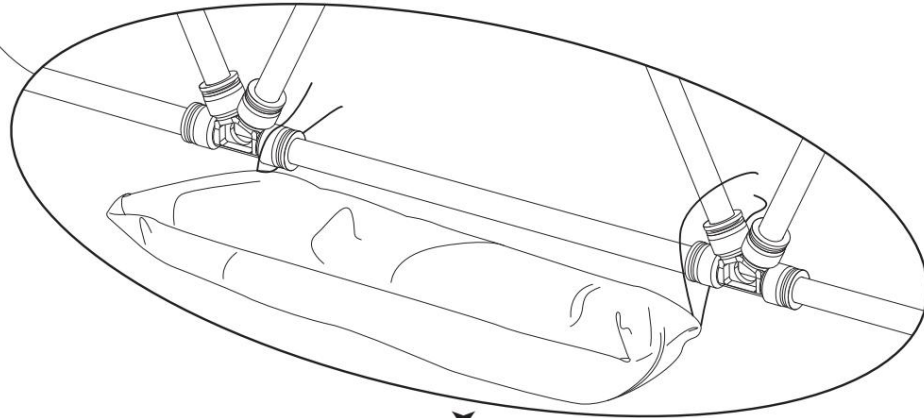
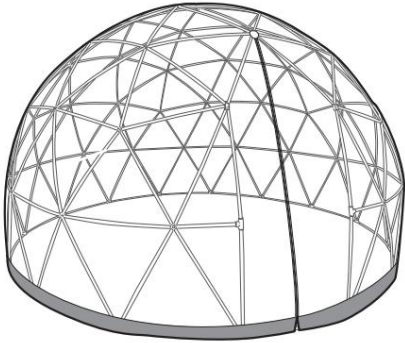

## Étape 17

conseils : La housse en PVC présentera de légères rides après le premier assemblage. Rester au soleil pendant environ une heure améliorera les rides.



AVERTISSEMENT

GARDER TOUTES LES SOURCES DE FLAMME ET DE CHALEUR  
LOIN DE CE TISSU DE DÔME

**Manufacturer:**Shanghaimuxinmuyeyouxiangongsi

**Address:** Shuangchenglu 803nong11hao1602A-1609shi, baoshanqu, shanghai 200000 CN.

**Imported to AUS:** SIHAO PTY LTD. 1 ROKEVA STREETEASTWOOD NSW 2122 Australia

**Imported to USA:** Sanven Technology Ltd. Suite 250, 9166 Anaheim Place, Rancho Cucamonga, CA 91730



E-CrossStu GmbH  
Mainzer Landstr.69, 60329 Frankfurt am Main.



YH CONSULTING LIMITED.  
C/O YH Consulting Limited Office 147, Centurion House,  
London Road, Staines-upon-Thames, Surrey, TW18 4AX



**VEVOR<sup>®</sup>**

**TOUGH TOOLS, HALF PRICE**

Technical Support and E-Warranty Certificate

[www.vevor.com/support](http://www.vevor.com/support)

# **VEVOR<sup>®</sup>**

## **TOUGH TOOLS, HALF PRICE**

Technical Support and E-Warranty Certificate [www.vevor.com/support](http://www.vevor.com/support)

## **TUIN BUITEN DUIDELIJK DOOM HANDLEIDING**

We blijven ons inzetten om u gereedschap tegen een concurrerende prijs te bieden.

'Bespaar de helft', 'Halve prijs' of andere soortgelijke uitdrukkingen die door ons worden gebruikt vertegenwoordigen slechts een schatting van de besparingen die u zou kunnen profiteren als u bepaalde gereedschappen bij ons koopt in vergelijking met de grote topmerken en betekenen niet noodzakelijkerwijs dat ze alle categorieën van aangeboden gereedschappen dekken. door ons. Wij verzoeken u vriendelijk om bij het plaatsen van een bestelling bij ons goed na te gaan of u daadwerkelijk de helft bespaart in vergelijking met de grote topmerken.

**VEVOR**<sup>®</sup>  
TOUGH TOOLS, HALF PRICE

TUIN BUITEN DUIDELIJK  
DOOM

Model: GB-DOME-12, GB-DOME-12T, GB-DOME-9,5 GB-DOME-9,5T

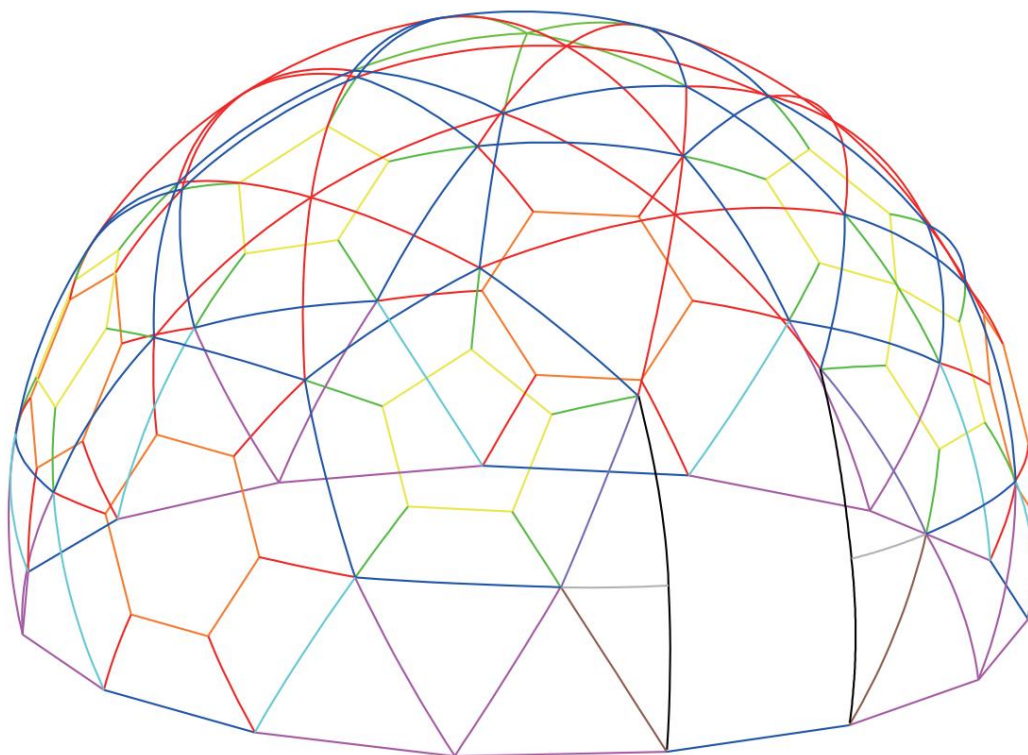

HULP NODIG? NEEM CONTACT MET ONS OP!

Heeft u productvragen? Technische ondersteuning nodig? Neem gerust contact met ons op: Technische ondersteuning en e-garantiecertificaat [www.vevor.com/support](http://www.vevor.com/support)

Dit is de originele instructie. Lees alle instructies in de handleiding zorgvuldig door voordat u ermee aan de slag gaat. VEVOR behoudt zich een duidelijke interpretatie van onze gebruikershandleiding voor. Het uiterlijk van het product is afhankelijk van het product dat u heeft ontvangen. Vergeef ons alstublieft dat we u niet opnieuw informeren als er technologie- of software-updates zijn voor ons product.

# SPECIFICATIES

Model	GB-DOME-12
Product grootte	12ft
Kleur	Transparant
Laad capaciteit	110 pond

Model	GB-DOME-12T
Product grootte	12ft
Kleur	Transparant
Laad capaciteit	110 pond

Model	GB-DOME-9.5
Product grootte	9,5ft
Kleur	Transparant
Laad capaciteit	110 pond







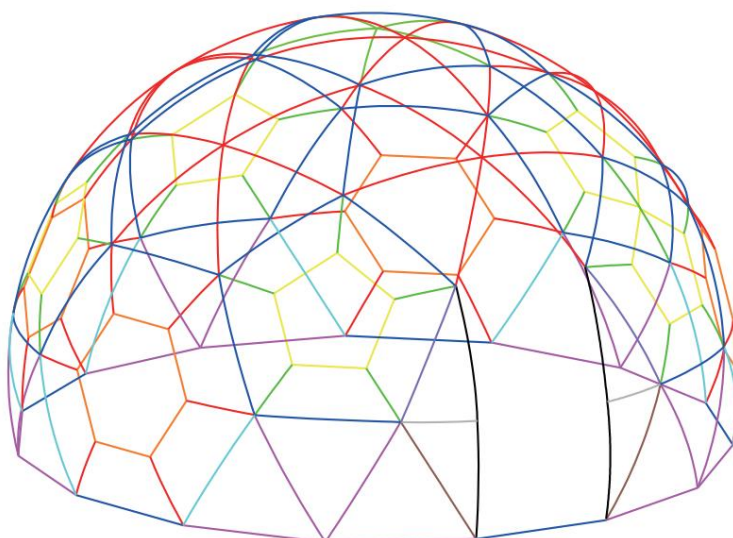

Model	GB-DOME-9.5T
Product grootte	9,5ft
Kleur	Transparant
Laad capaciteit	110 pond

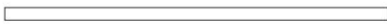
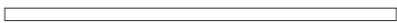
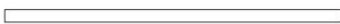
# Accessoires

Model	PVC transparante hoes	Muggenhoos
GB-DOME-12	✓	×
GB-DOME-12T	✓	✓
GB-DOME-9.5	✓	×
GB-DOME-9.5T	✓	✓

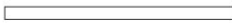

Leidingen :

- A  5 stuks
- B  42 stuks
- C  50 stuks
- D  4 stuks
- E  8 stuks
- G  2 stuks
- H  2 stuks
- I  2 stuks
- J  25 stuks
- K  25 stuks
- L  24 stuks
- M  24 stuks

Omslag:

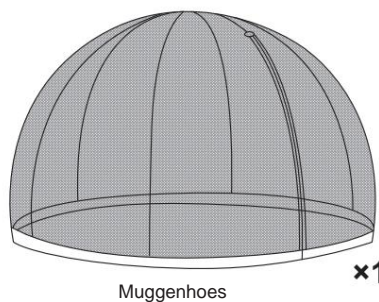
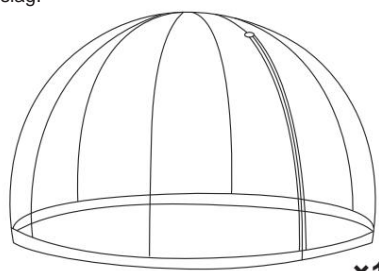

Standaardbeoordelingen:

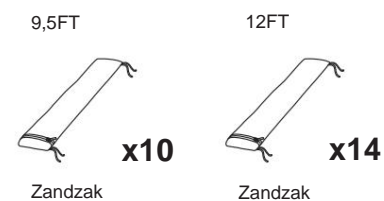
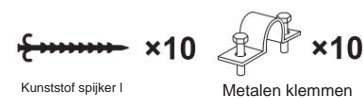

Connectoren:

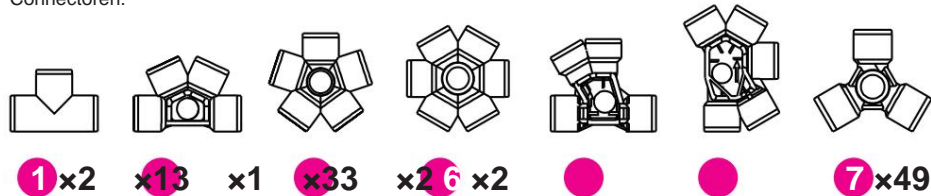

# Stap-01

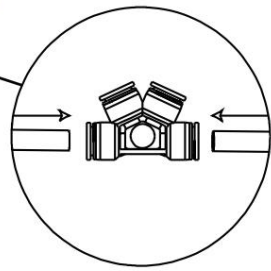
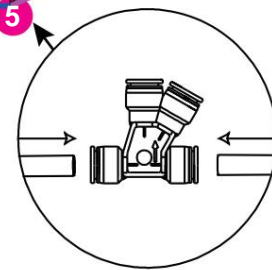
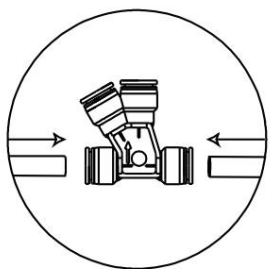
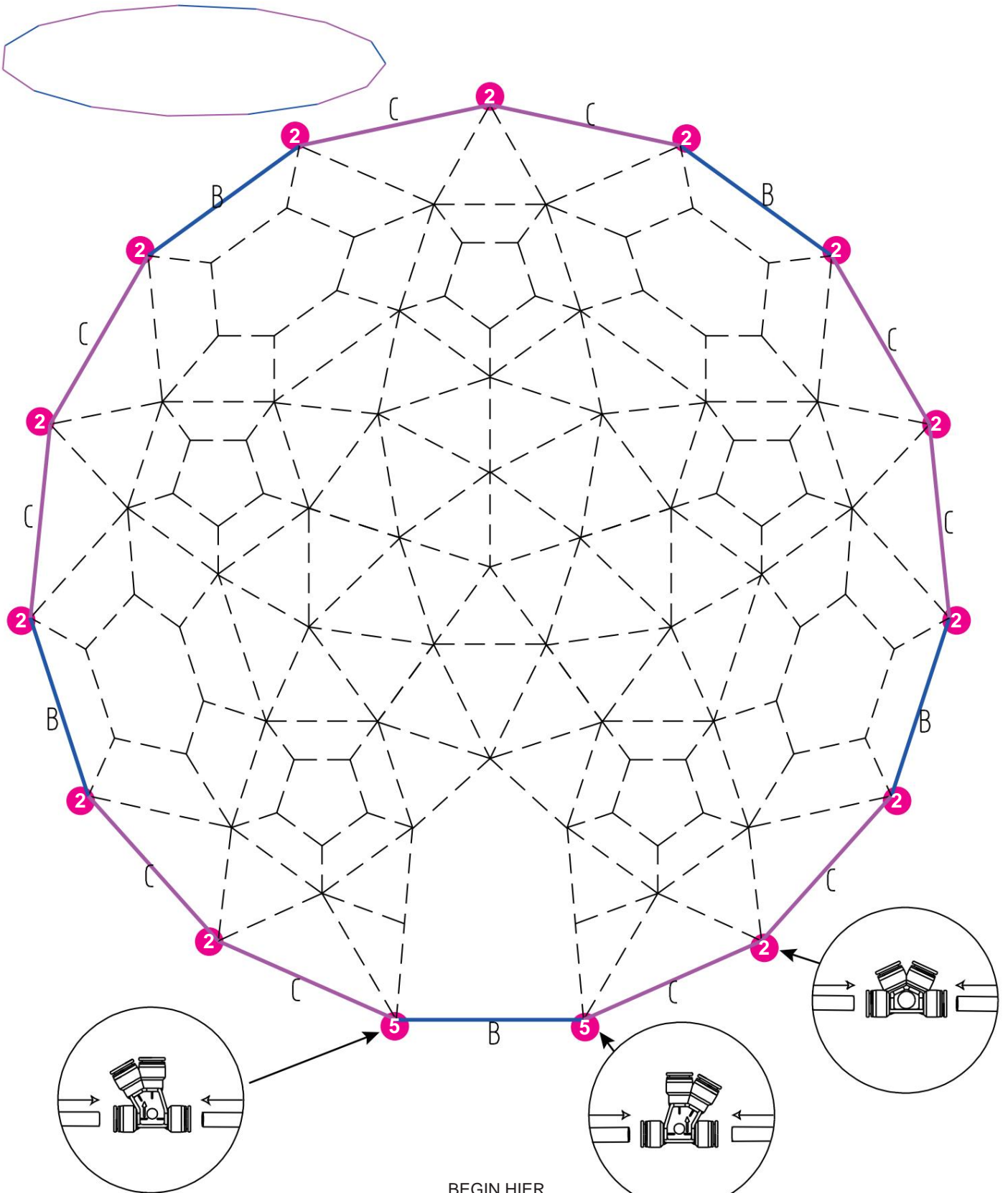

BEGIN HIER

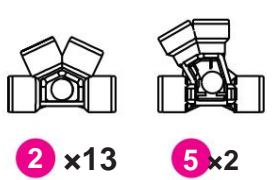
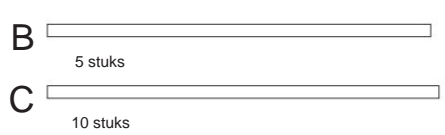
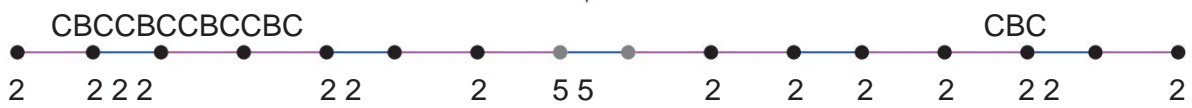

# Stap-02

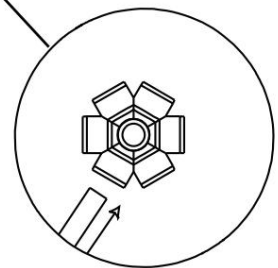
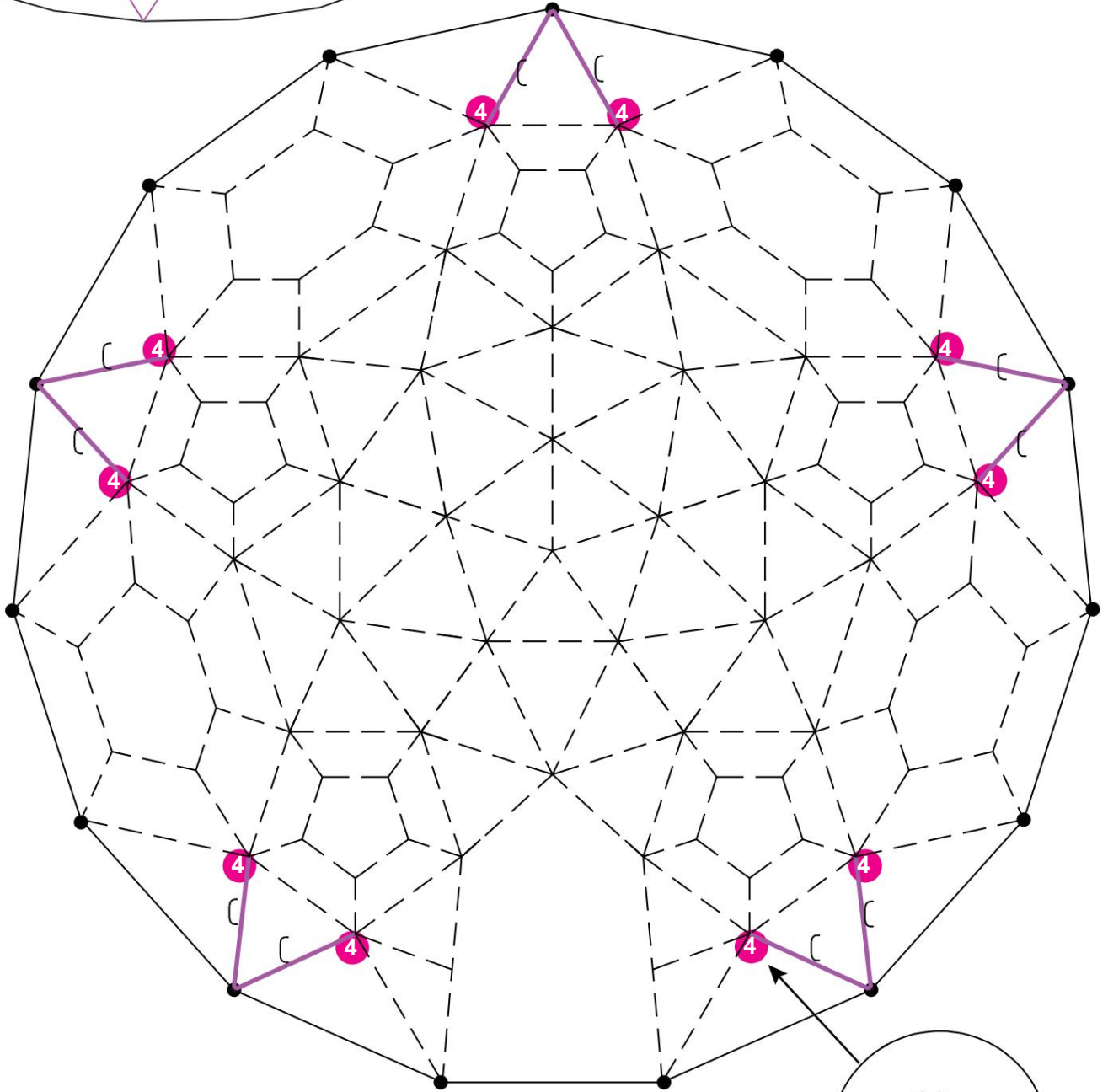
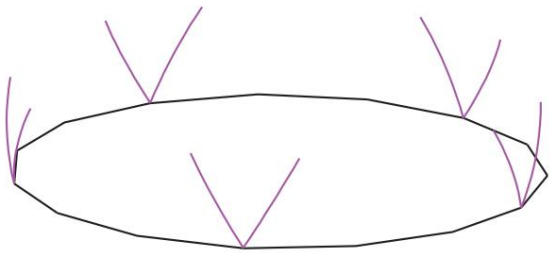

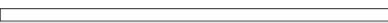
C   
10 stuks

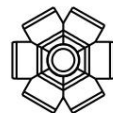

4 x10

# Stap-03

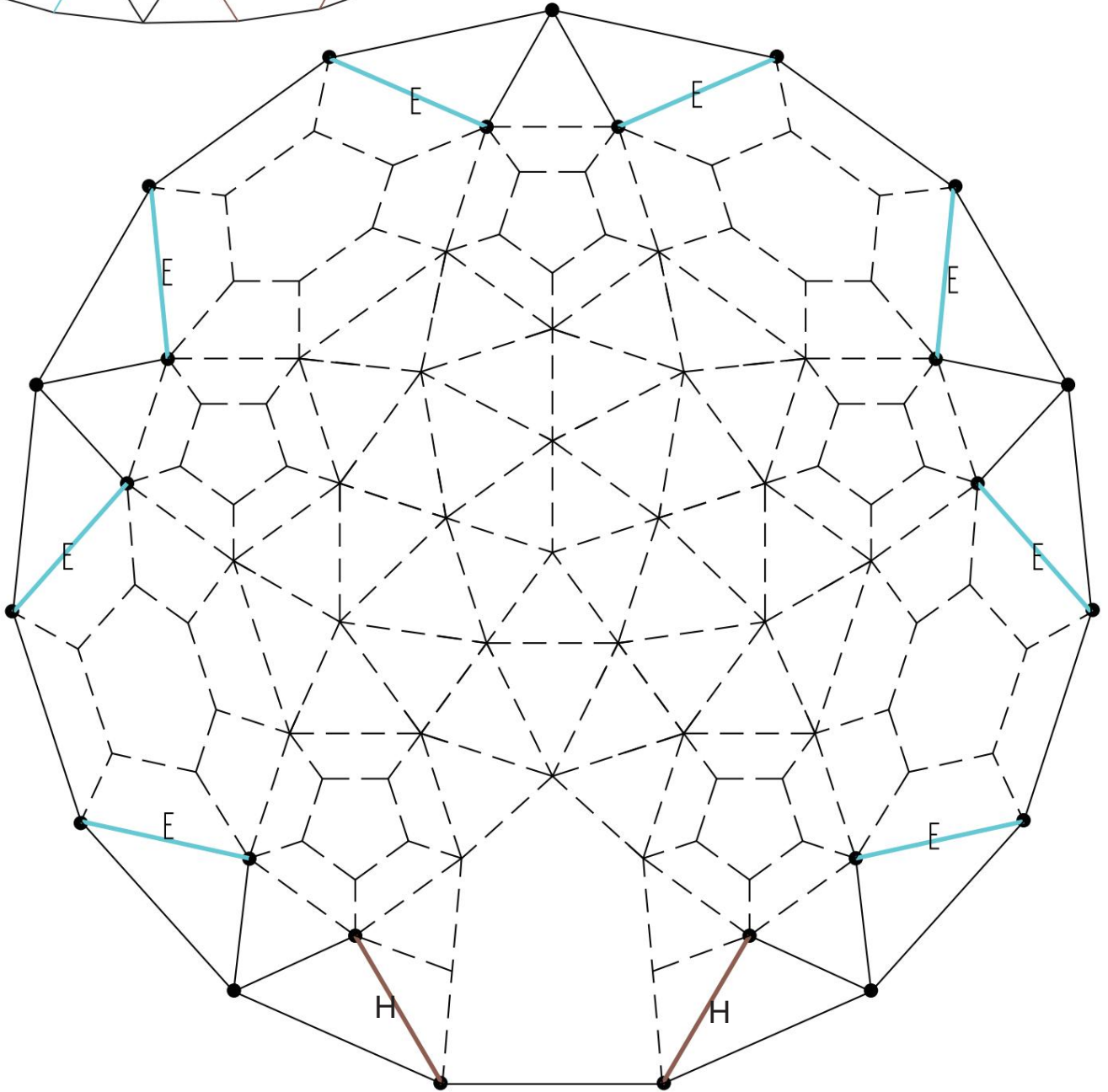
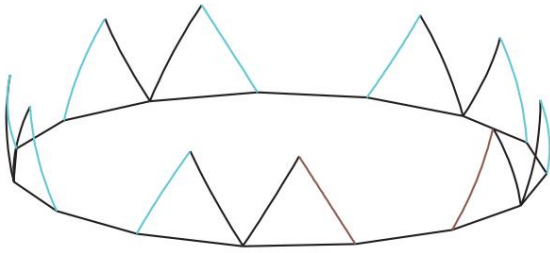

E   
8 stuks

H   
2 stuks



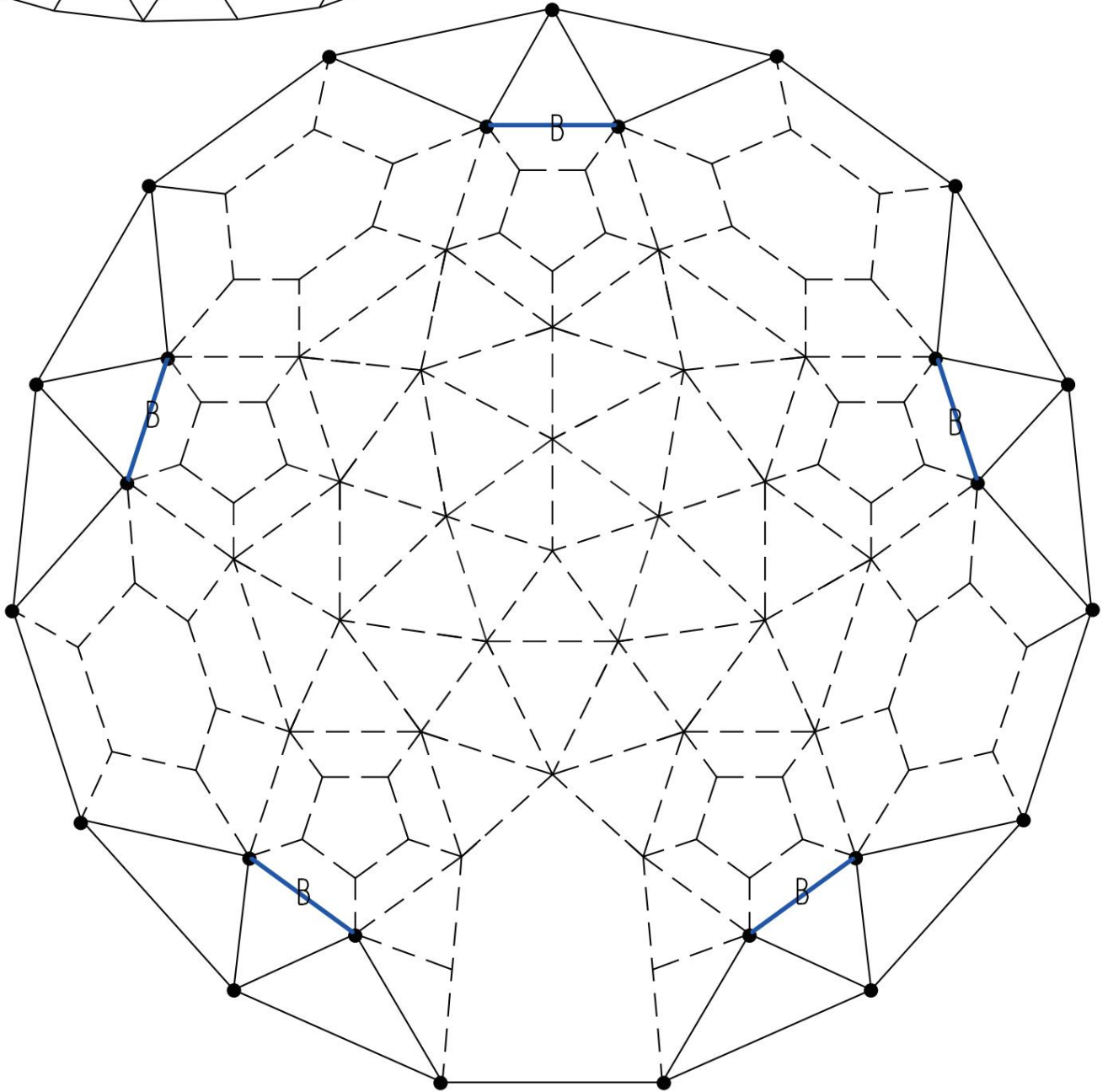
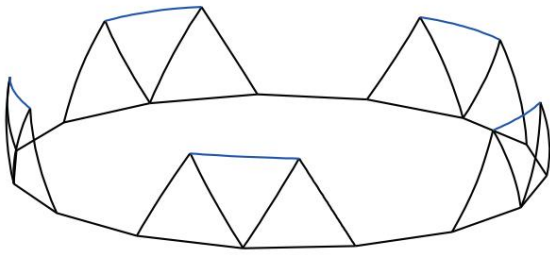

# Stap-04

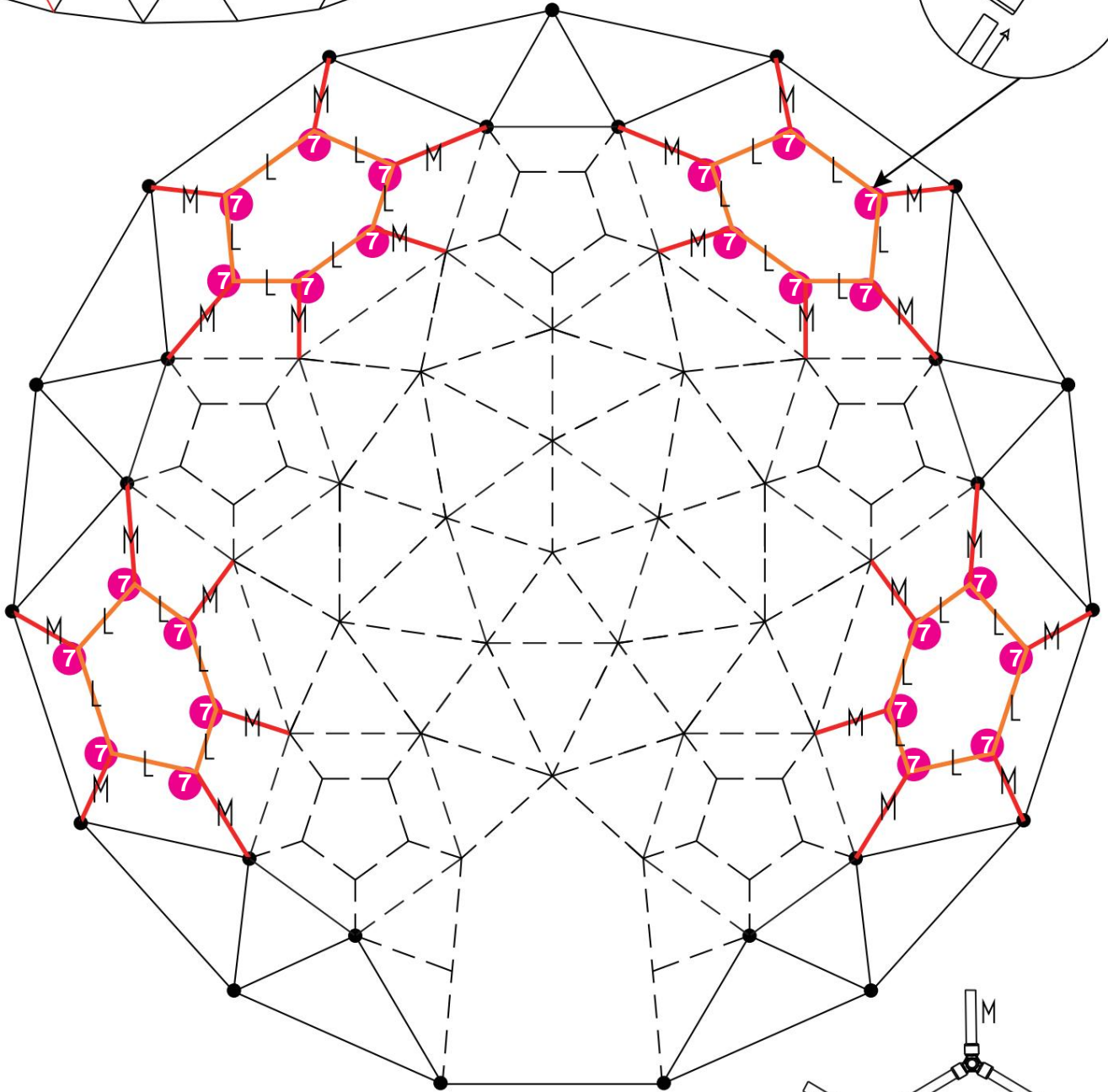
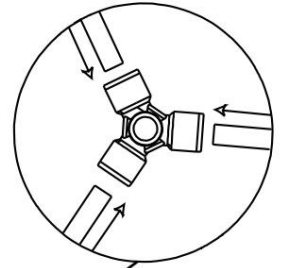
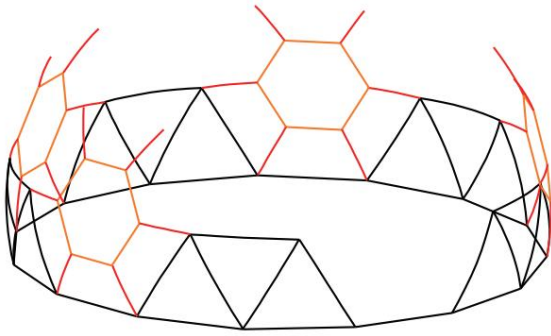

B   
5 stuks

# Stap-05



L  24 stuks  
M  24 stuks



7 x24

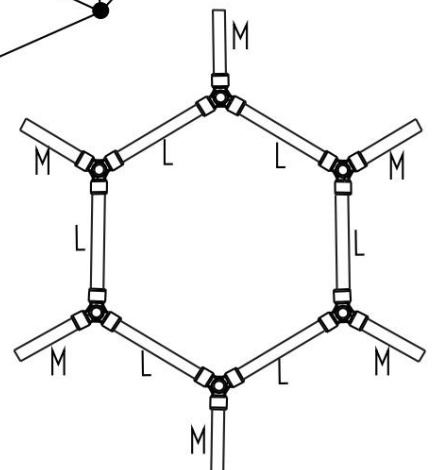

# Stap-06

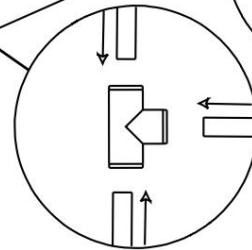
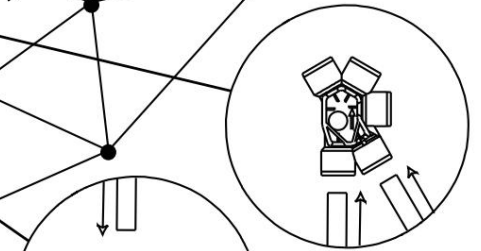
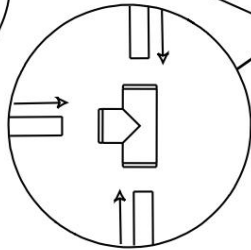
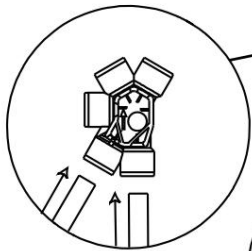
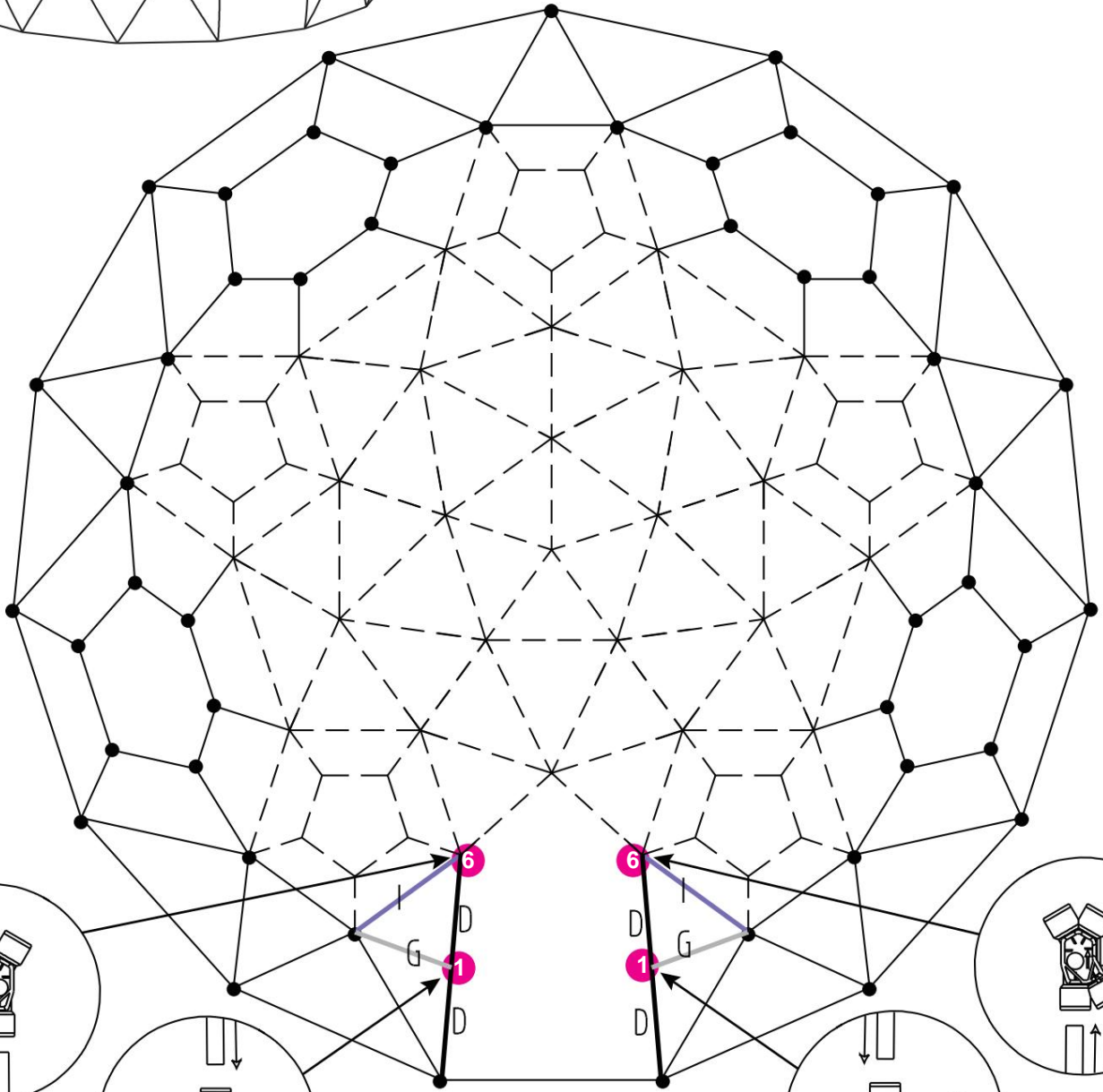
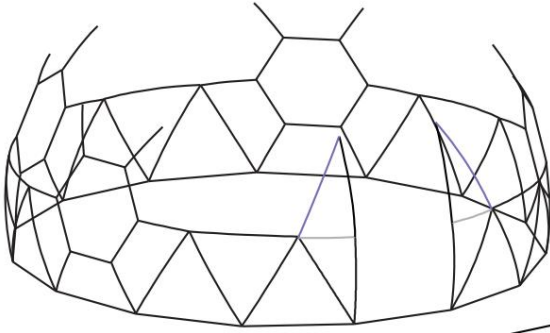

D  4 stuks

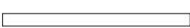
G  2 stuks

I  2 stuks

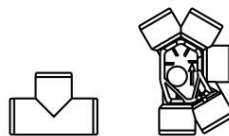

1 x 2

x 2

# Stap-07

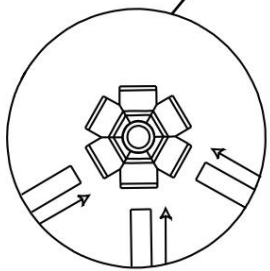
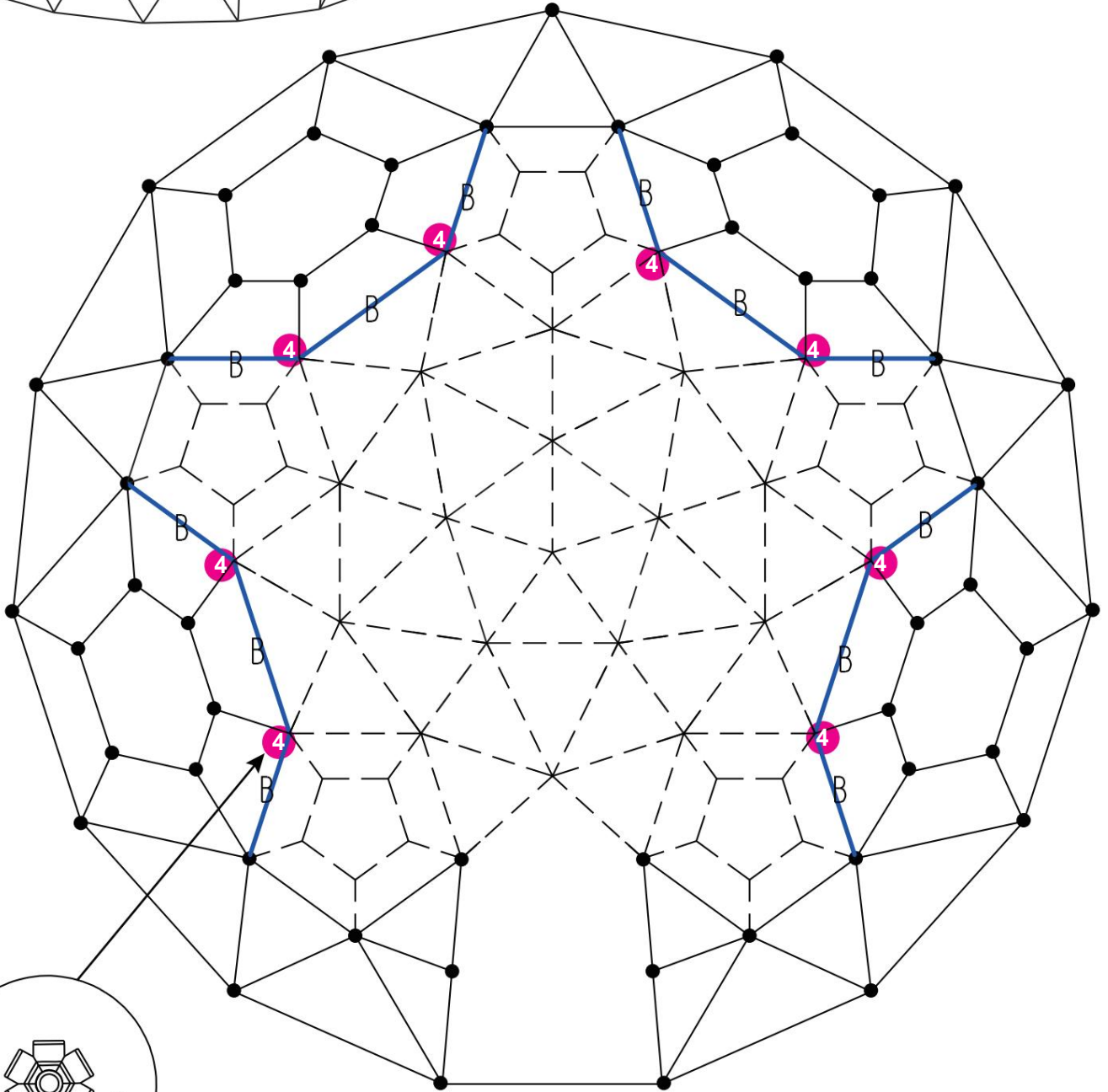
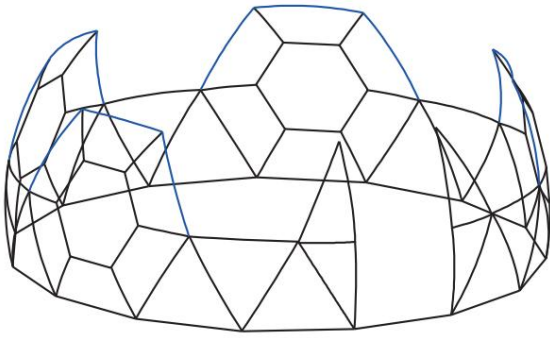



B  12 stuks

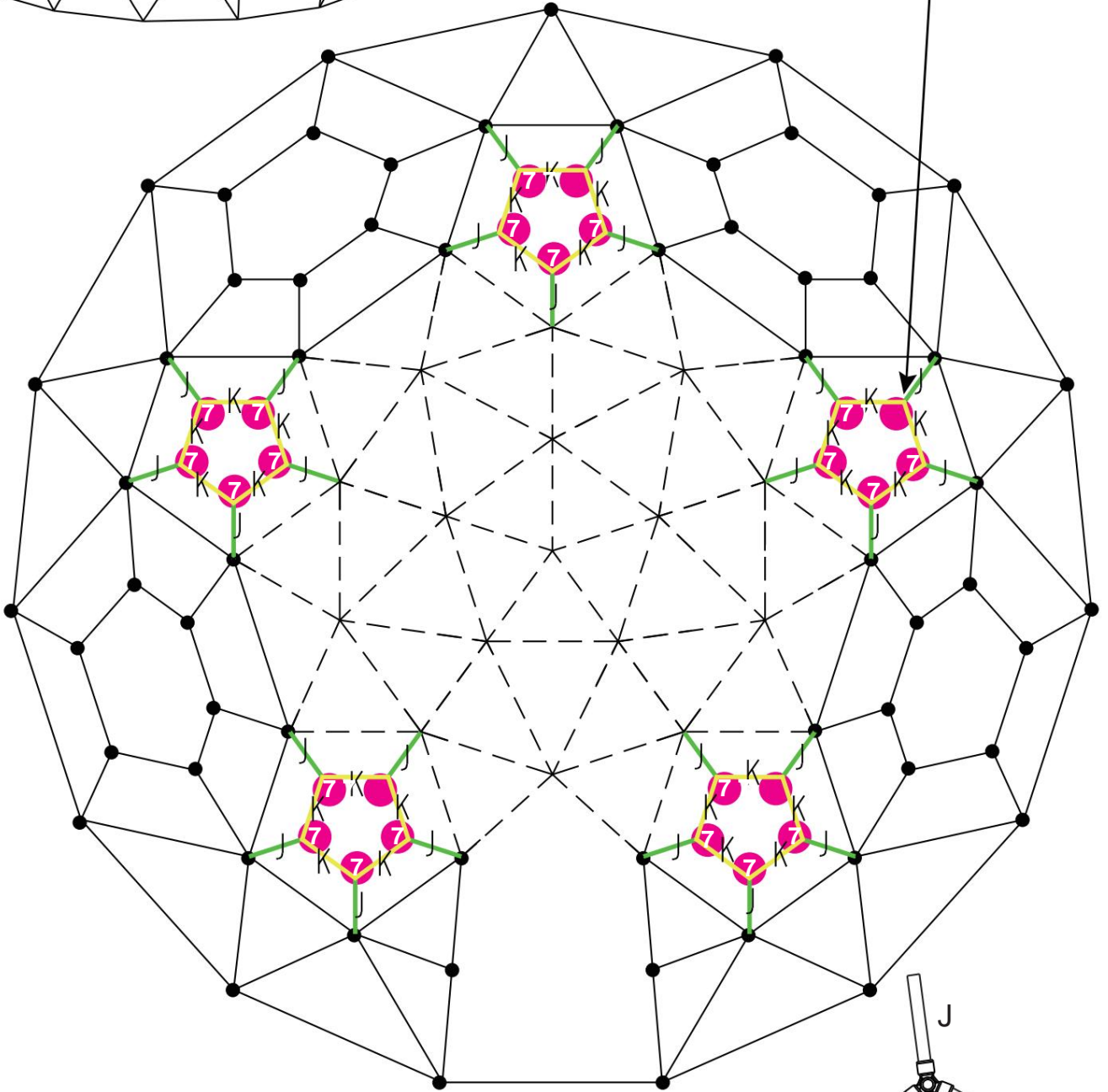
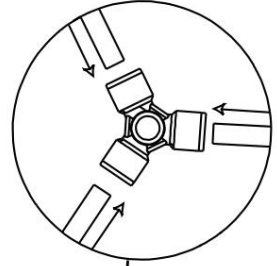
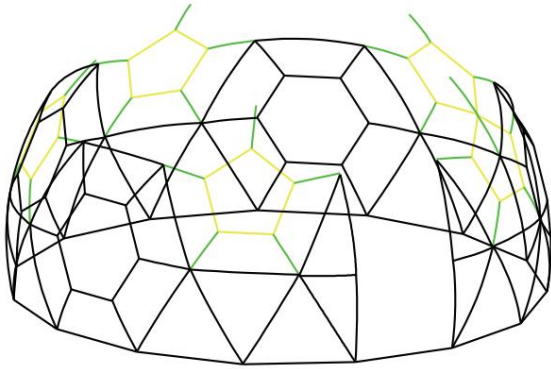

4 x 8

# Stap-08



J  25 stuks  
K  25 stuks

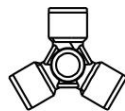

 x 25

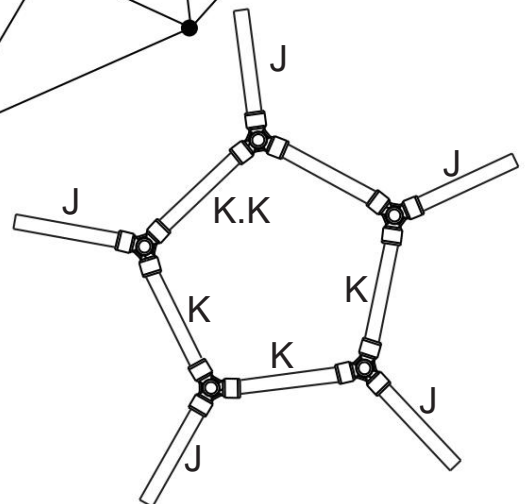

# Stap-09

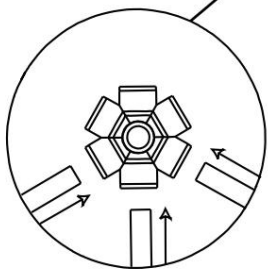
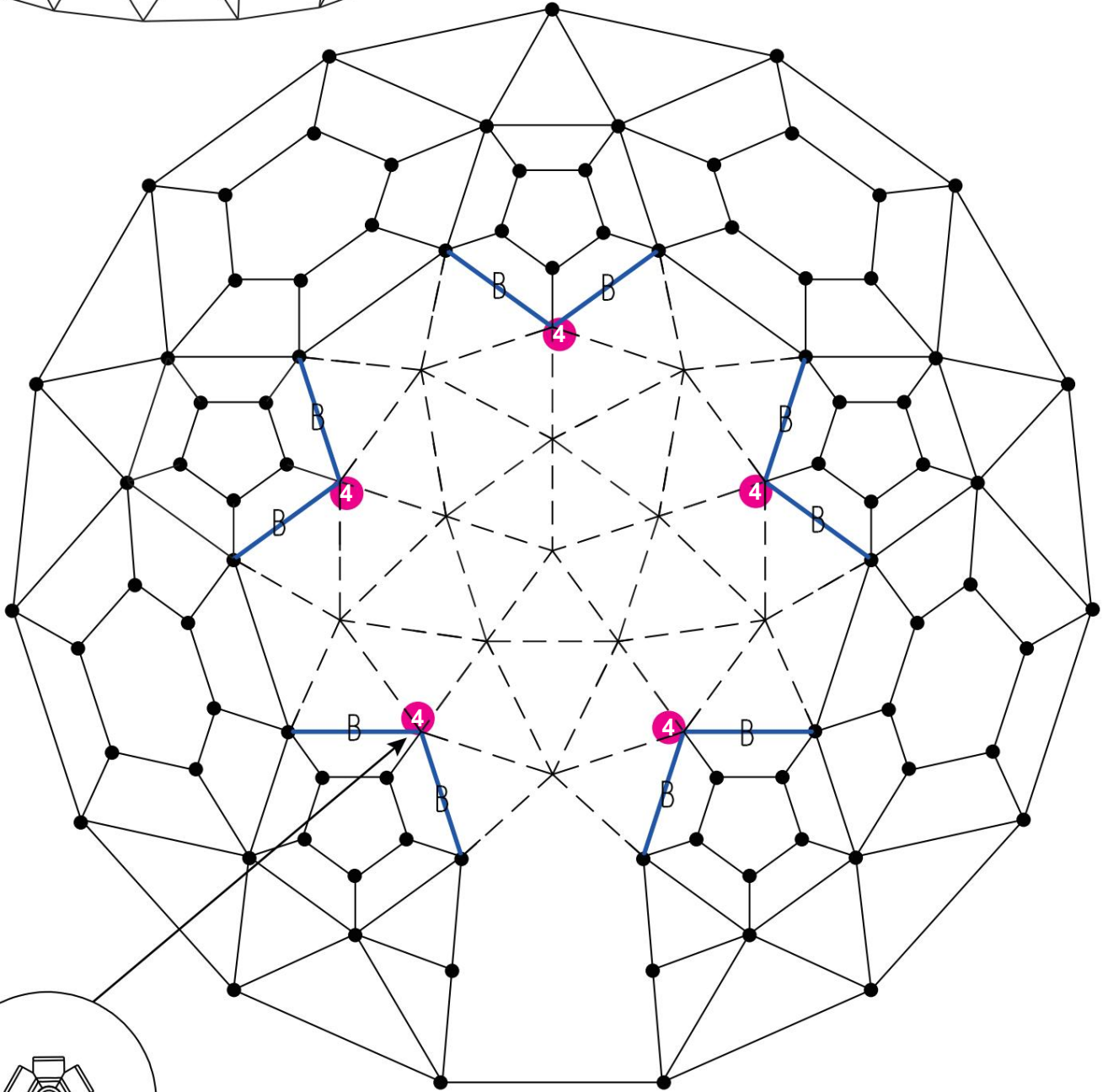
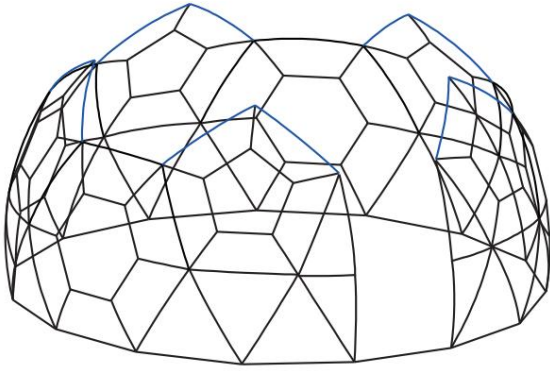

B   
10 stuks

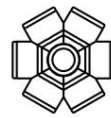

4 x5

# Stap-10

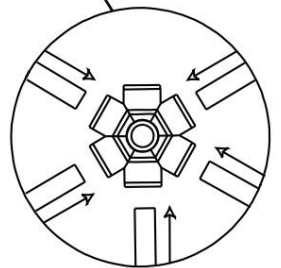
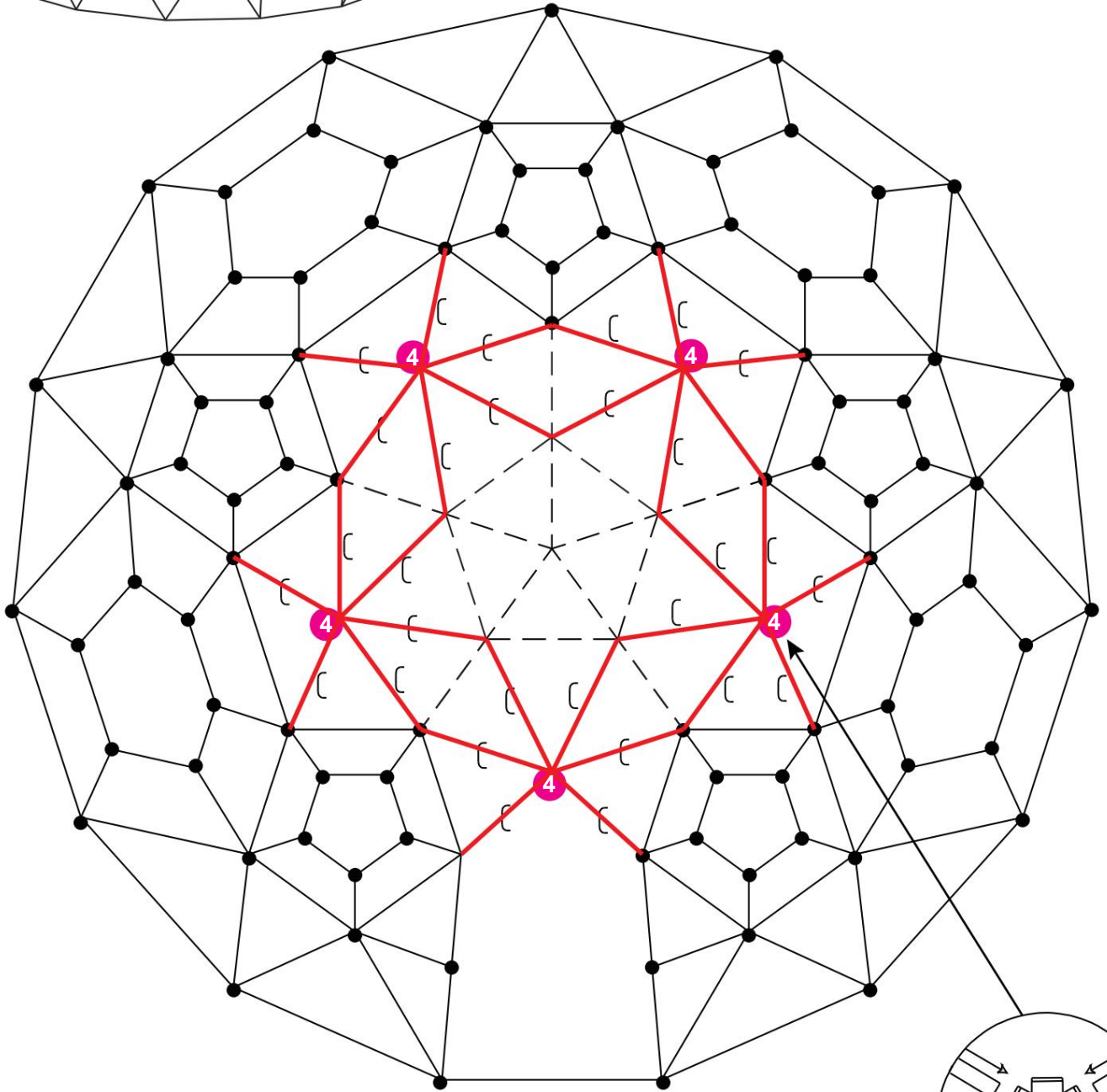
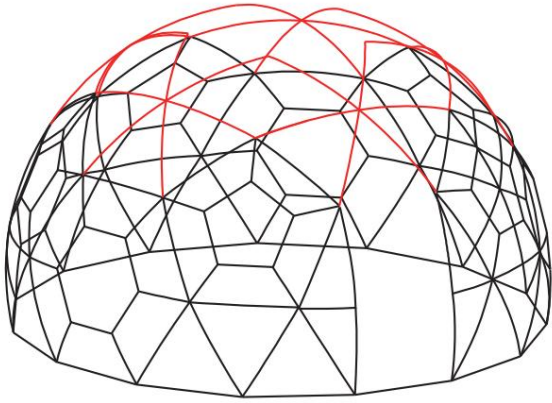

C   
71cm / 30 stuks



4 x5

# Step-11

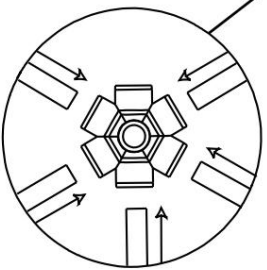
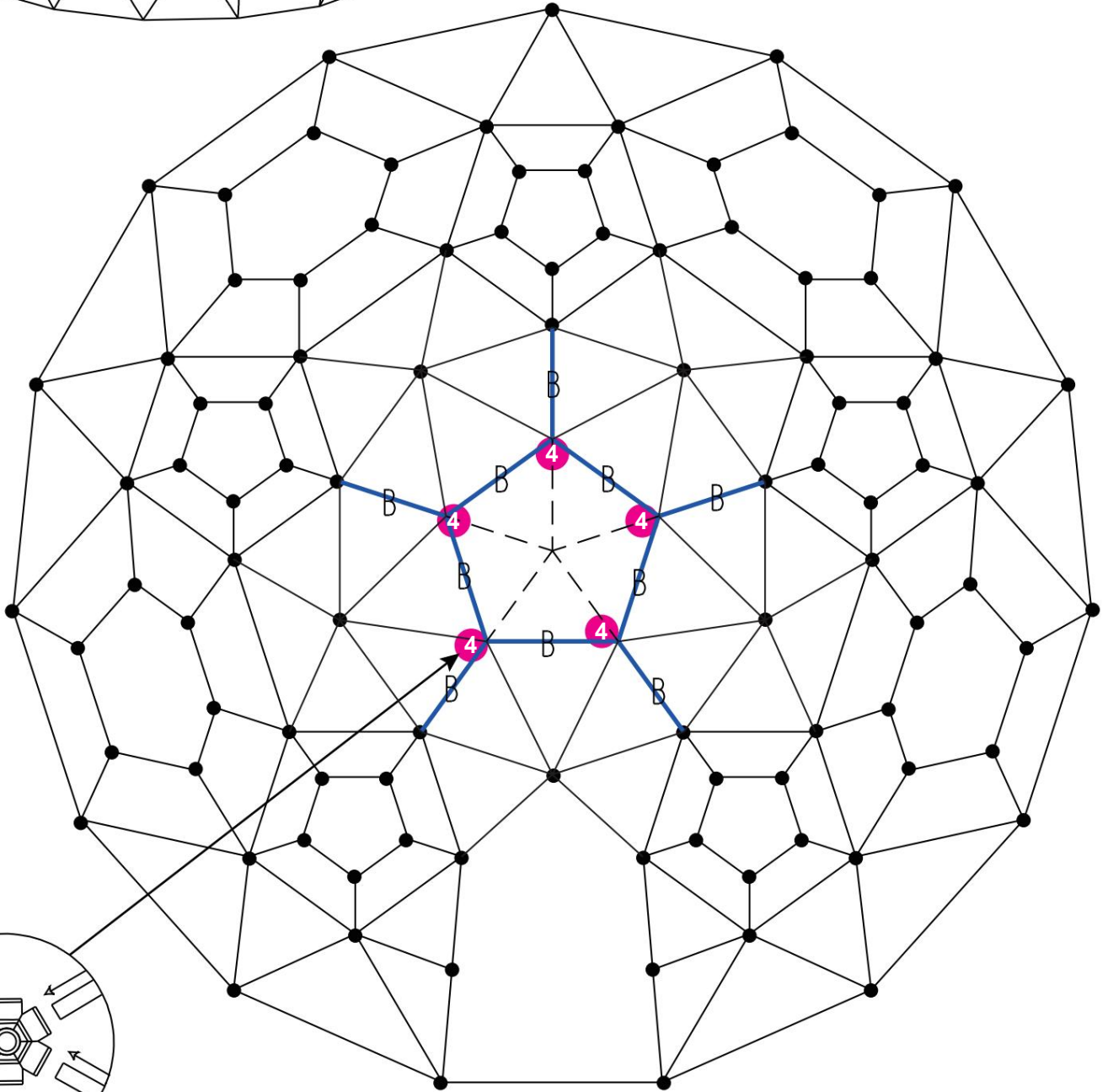
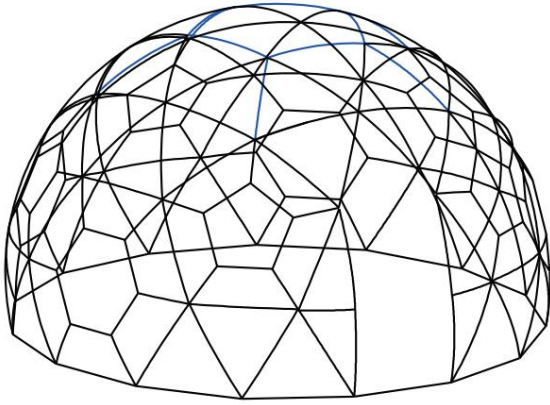

B   
10 stuks

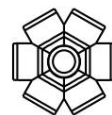

4 x 5

# Stap-12

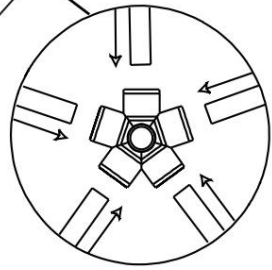
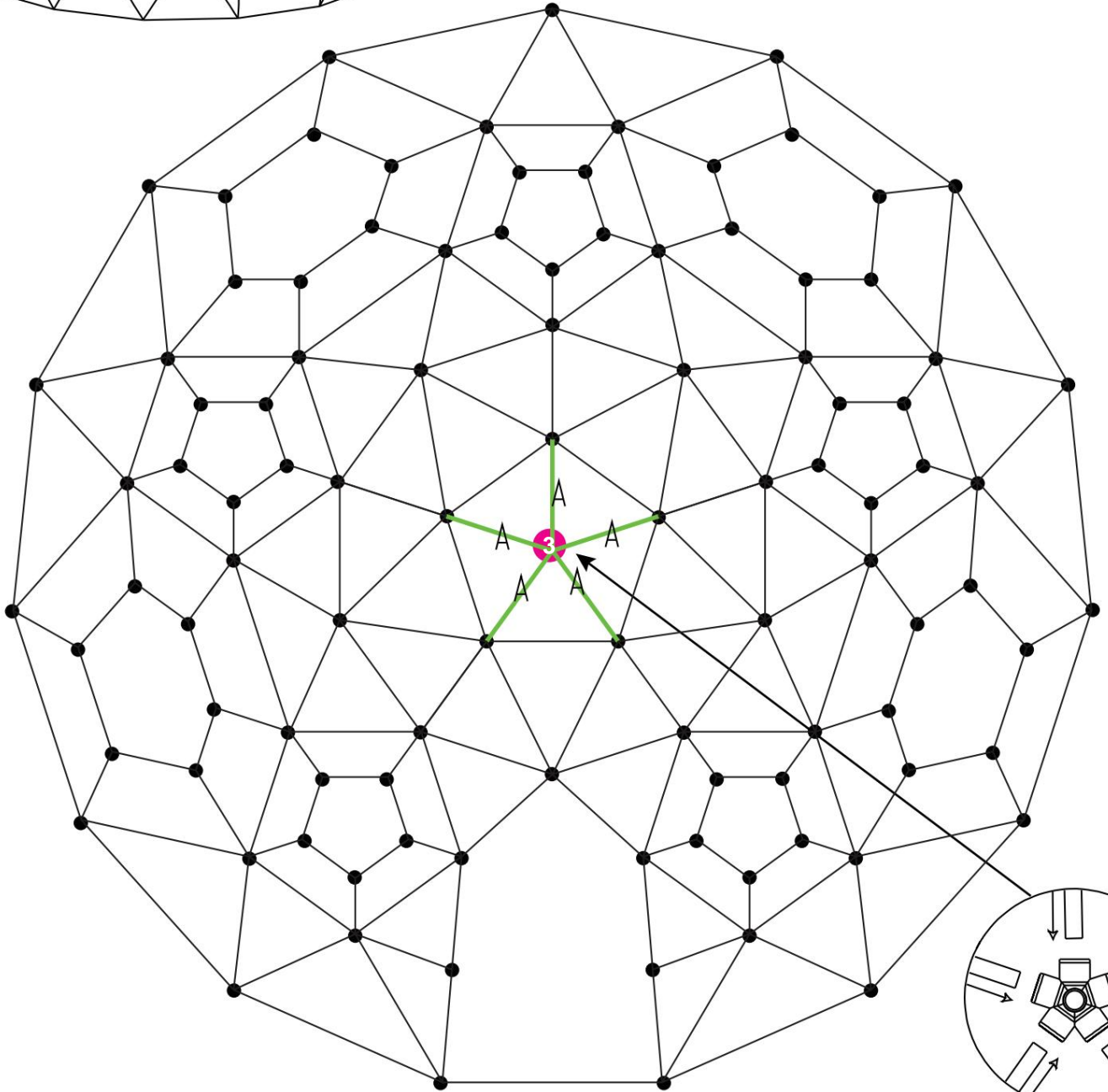
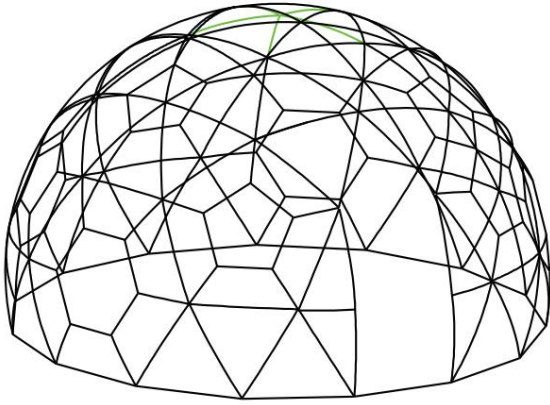

3x1

# Stap-13

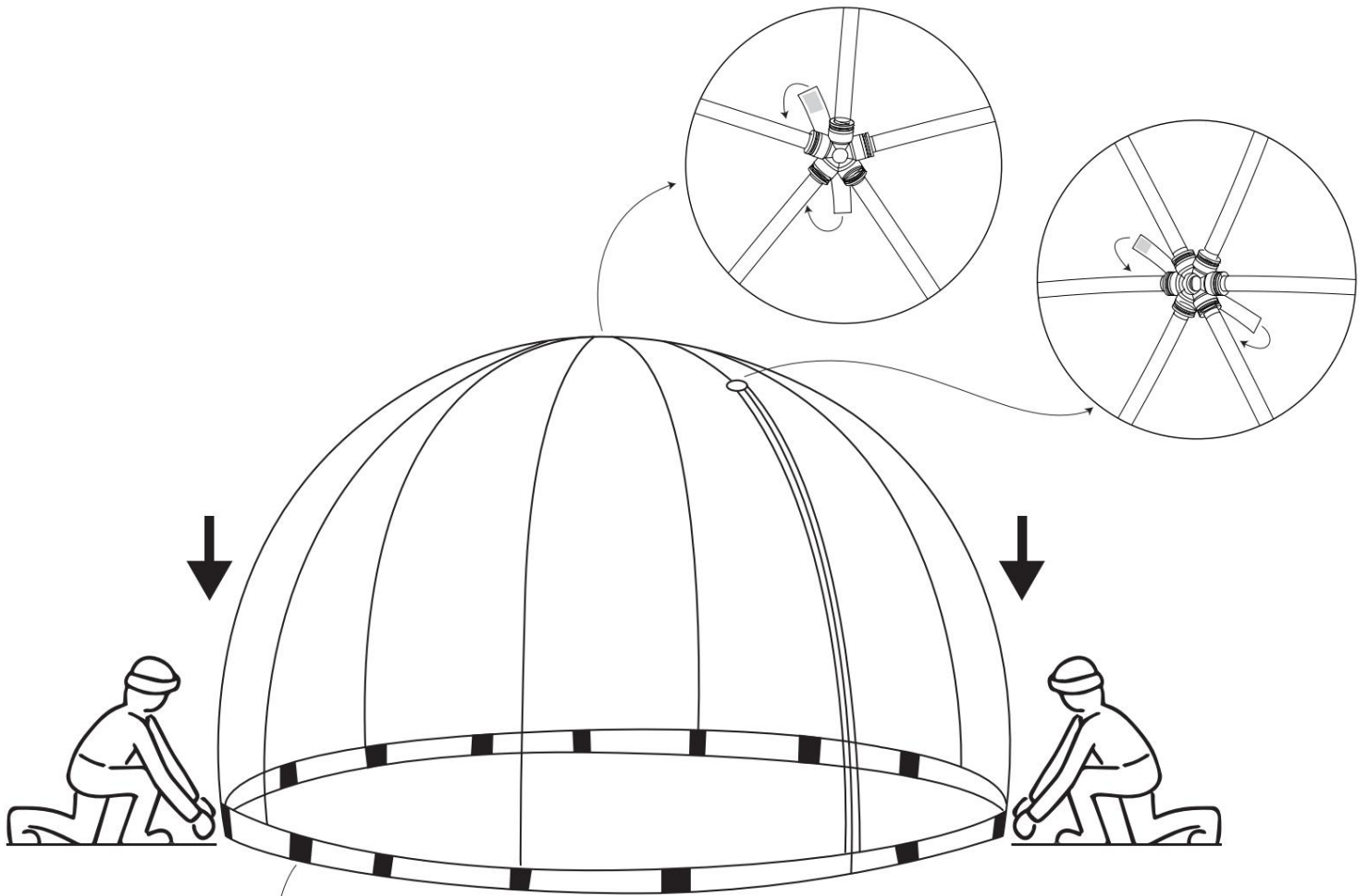

pvc-hoes of muggenhoes

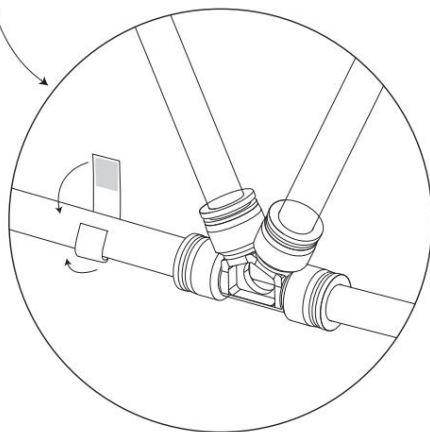

x 14



# Stap 14

## Optie 1

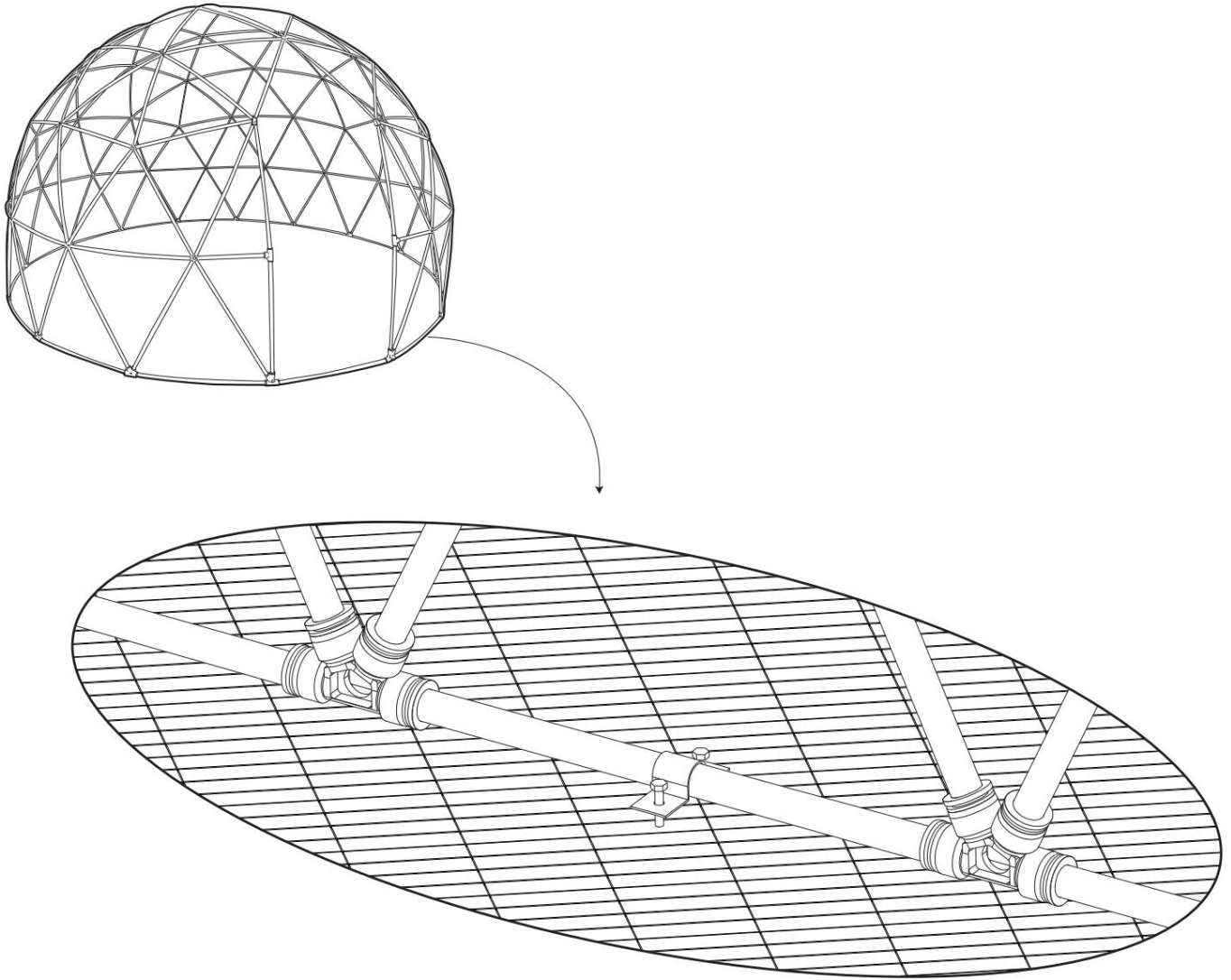

Installeer op de houten/WPC-vloer

# Stap-15

## Optie 2

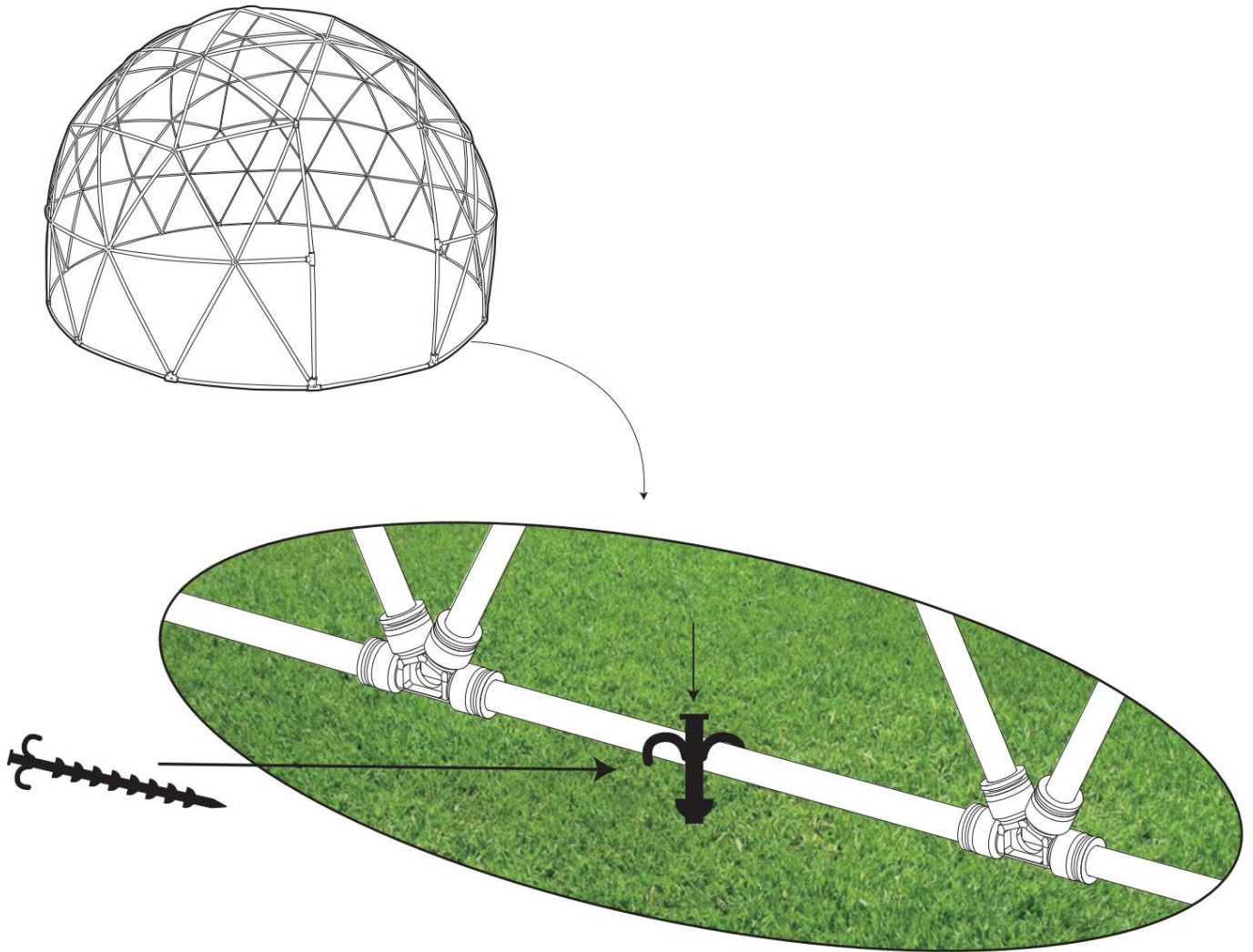

Installeer op de grasvloer

# Step-16

## Optie 3: zandzak

Let op: om windbreuk te voorkomen

is een zandzak noodzakelijk, 14st

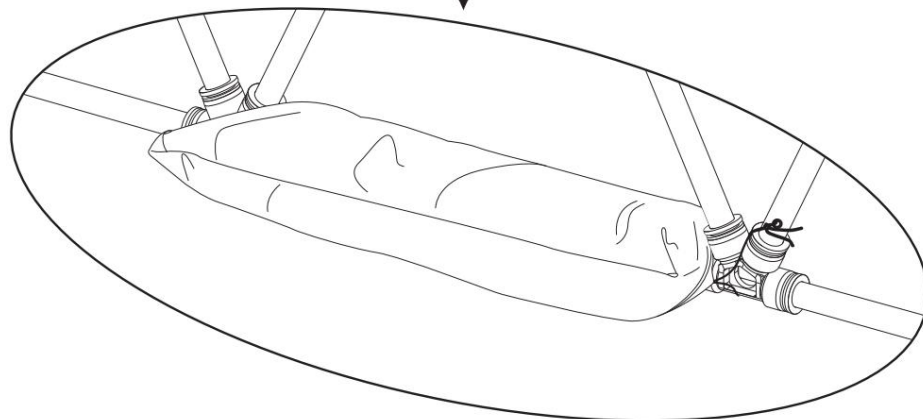
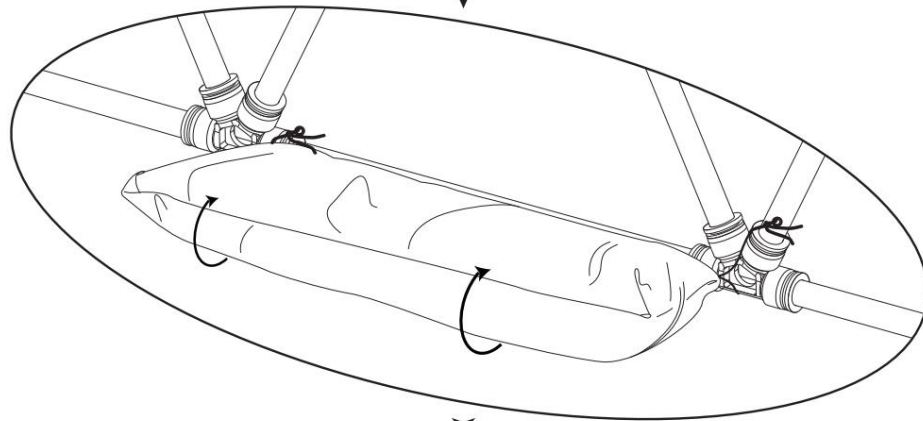
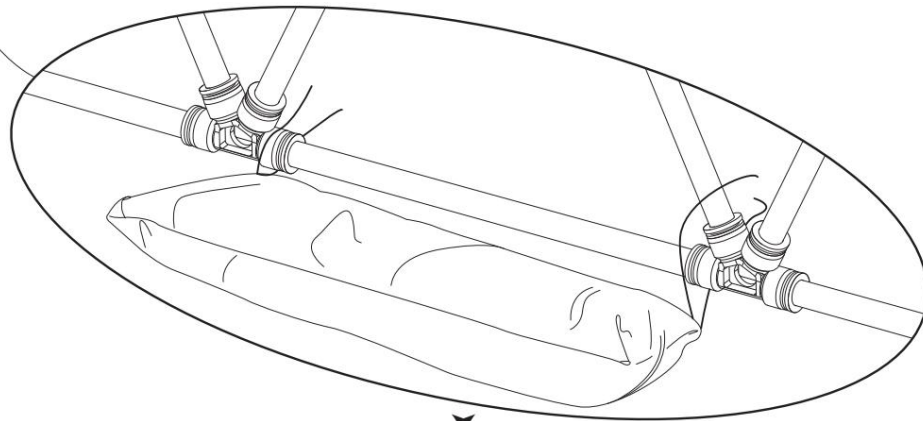
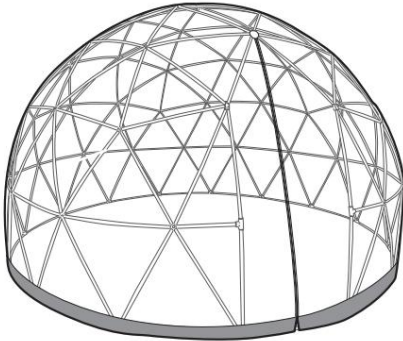

# Stap-17

tips:

De PVC-hoes zal na de eerste montage lichte rimpels vertonen. Ongeveer een uur onder de zon blijven uur zal rimpels verbeteren.



**WAARSCHUWING**

**BEWAAR ALLE VLAM- EN WARMTEBRONNEN  
WEG VAN DEZE KOEPELSTOF**

**Manufacturer:**Shanghaimuxinmuyeyouxiangongsi

**Address:** Shuangchenglu 803nong11hao1602A-1609shi, baoshanqu, shanghai 200000 CN.

**Imported to AUS:** SIHAO PTY LTD. 1 ROKEVA STREETEASTWOOD NSW 2122 Australia

**Imported to USA:** Sanven Technology Ltd. Suite 250, 9166 Anaheim Place, Rancho Cucamonga, CA 91730



E-CrossStu GmbH  
Mainzer Landstr.69, 60329 Frankfurt am Main.



YH CONSULTING LIMITED.  
C/O YH Consulting Limited Office 147, Centurion House,  
London Road, Staines-upon-Thames, Surrey, TW18 4AX



**VEVOR**<sup>®</sup>

**TOUGH TOOLS, HALF PRICE**

Technical Support and E-Warranty Certificate

[www.vevor.com/support](http://www.vevor.com/support)

# **VEVOR<sup>®</sup>**

## **TOUGH TOOLS, HALF PRICE**

Technical Support and E-Warranty Certificate [www.vevor.com/support](http://www.vevor.com/support)

## **TRÄDGÅRD UTOMHUS CLEAR DOOM ANVÄNDARMANUAL**

Vi fortsätter att vara engagerade i att ge dig verktyg till konkurrenskraftiga priser. "Spara hälften", "halva priset" eller andra liknande uttryck som används av oss representerar bara en uppskattning av besparingar du kan dra nytta av att köpa vissa verktyg hos oss jämfört med de stora toppmärkena och betyder inte nödvändigtvis att täcka alla kategorier av verktyg som erbjuds av oss. Du påminns vänligen om att noggrant kontrollera när du gör en beställning hos oss om du faktiskt sparar hälften i jämförelse med de främsta stora varumärkena.

**VEVOR**<sup>®</sup>  
TOUGH TOOLS, HALF PRICE

TRÄDGÅRD UTOMHUS CLEAR  
UNDERGÅNG

Model: GB-DOME-12, GB-DOME-12T, GB-DOME-9.5 GB-DOME-9.5T

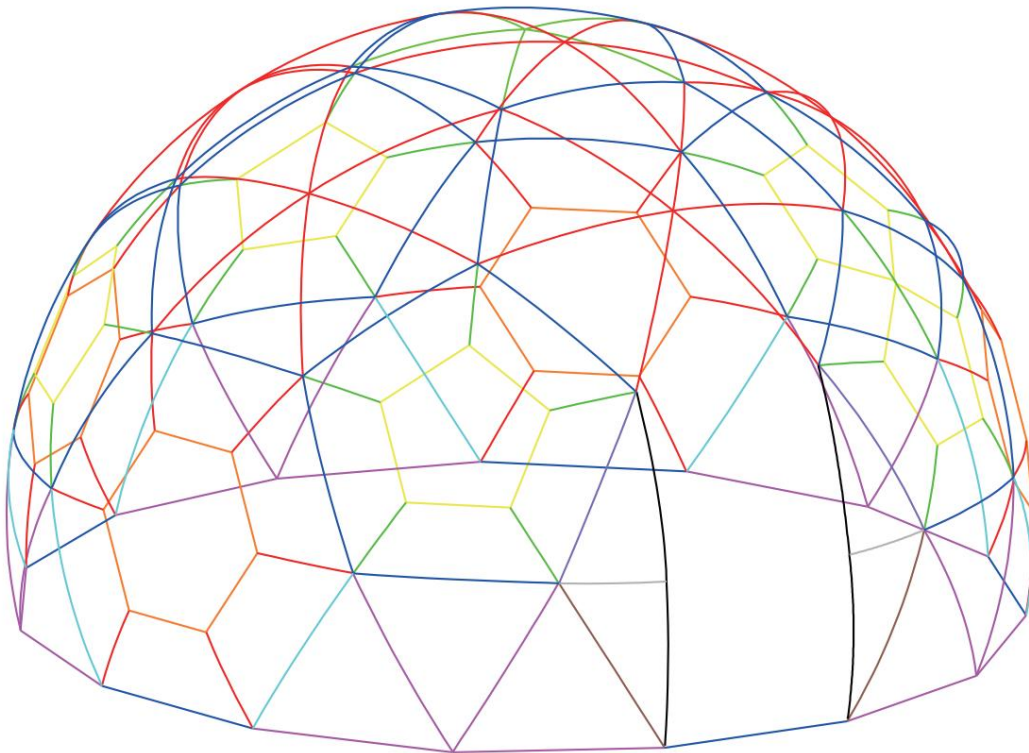

BEHÖVS HJÄLP? KONTAKTA OSS!

Har du produktfrågor? Behöver du teknisk support? Kontakta oss gärna: Teknisk support och e-garanticertifikat [www.vevor.com/support](http://www.vevor.com/support)

Detta är den ursprungliga instruktionen, läs alla instruktioner noggrant innan du använder den. VEVOR reserverar sig för en tydlig tolkning av vår användarmanual. Produktens utseende är beroende av den produkt du har fått. Ursäkta oss att vi inte kommer att informera dig igen om det finns någon teknik eller mjukvaruuppdateringar på vår produkt.

## SPECIFIKATIONER

Modell	GB-DOME-12
Produktstorlek	12 fot
Färg	Transparent
Lastkapacitet	110 lb

Modell	GB-DOME-12T
Produktstorlek	12 fot
Färg	Transparent
Lastkapacitet	110 lb

Modell	GB-DOME-9.5
Produktstorlek	9,5 fot
Färg	Transparent
Lastkapacitet	110 lb







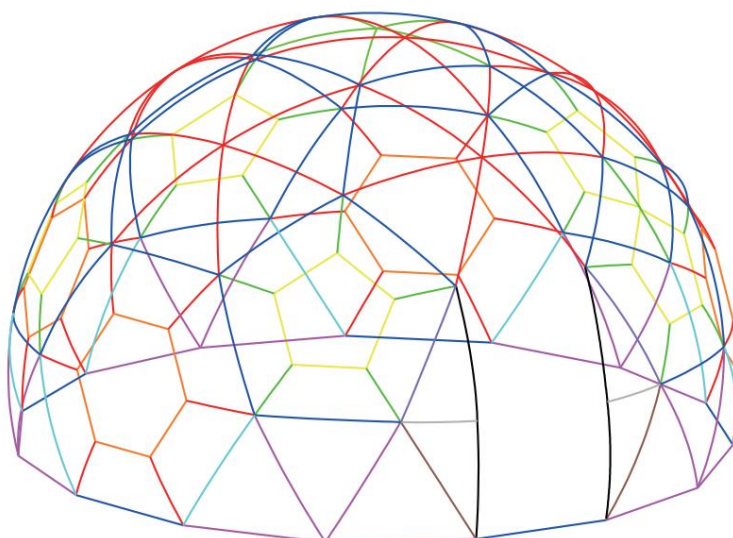

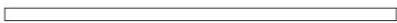
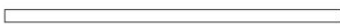

Modell	GB-DOME-9.5T
Produktstorlek	9,5 fot
Färg	Transparent
Lastkapacitet	110 lb

# Tillbehör

Modell	Genomskinligt PVC-hölje	Myggskydd
GB-DOME-12	✓	×
GB-DOME-12T	✓	✓
GB-DOME-9.5	✓	×
GB-DOME-9.5T	✓	✓

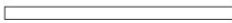

Rör:

- A  5 st
- B  42 st
- C  50 st
- D  4 st
- E  8 st
- G  2 st
- H  2 st
-  2 st
- J  25 st
- K  25 st
- L  24 st
- M  24 st

Omslag:

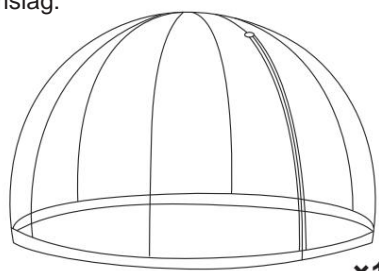

Genomskinligt PVC-hölje

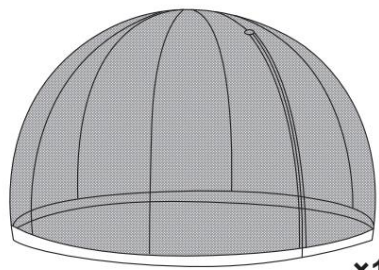

Myggskydd

Standardbedömningar:

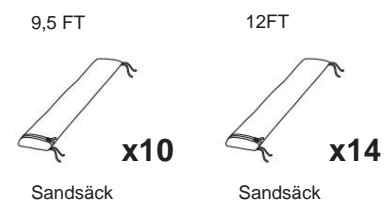
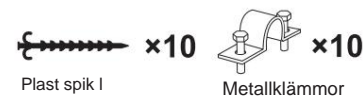

Kontakter:

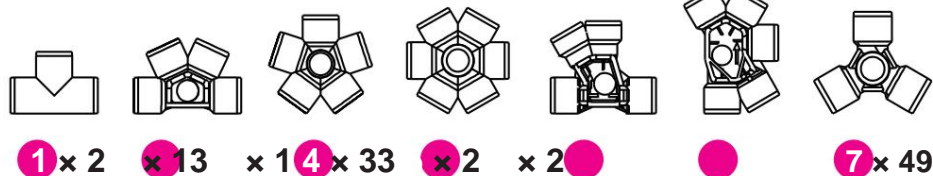

# Steg-01

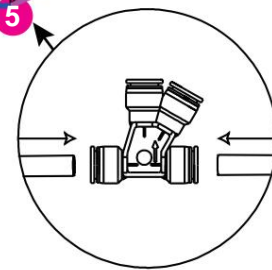
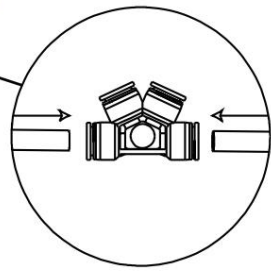
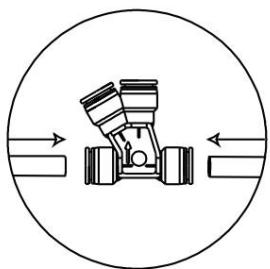
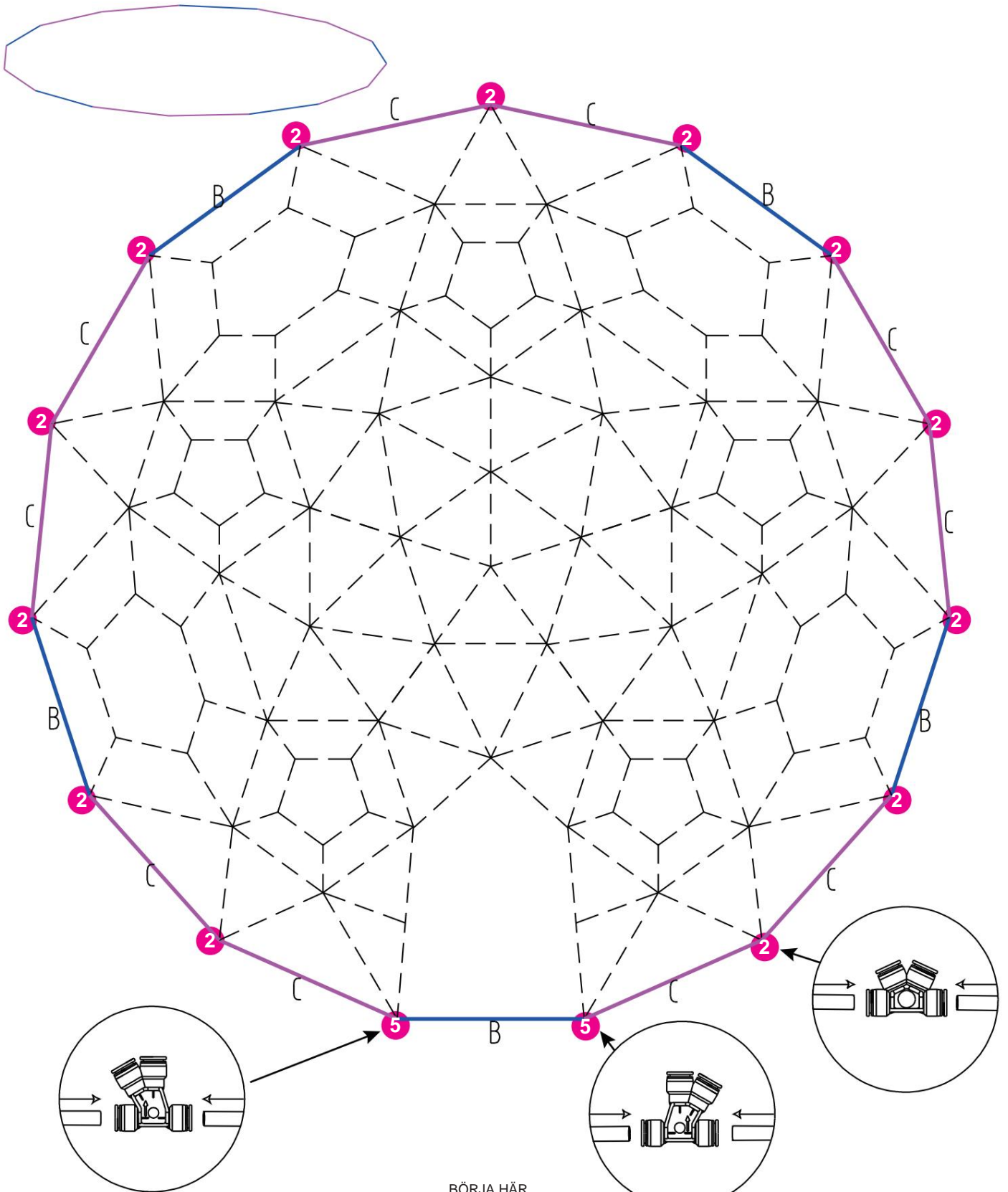

BÖRJA HÄR  
↓

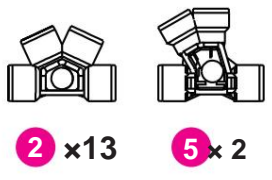
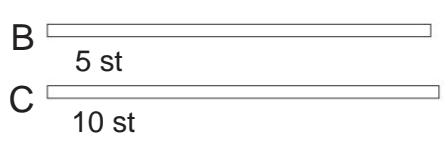
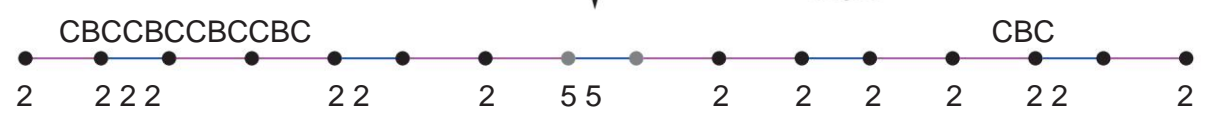

# Step-02

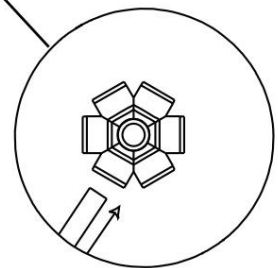
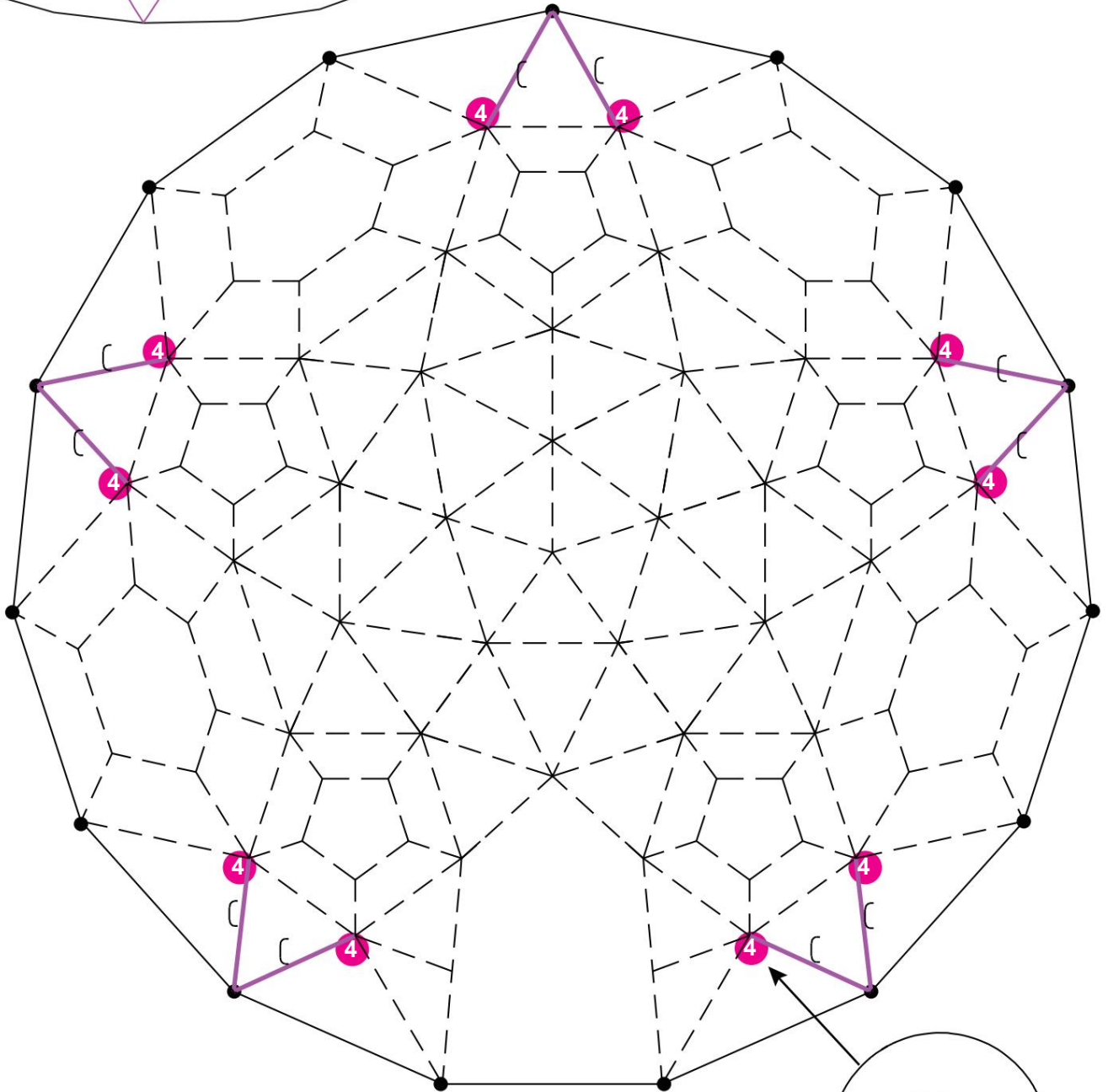
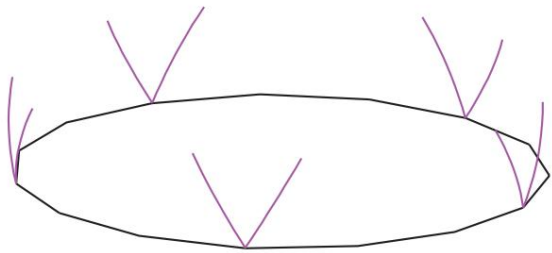

C  10 st

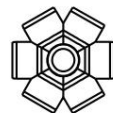

4 x10

# Step-03

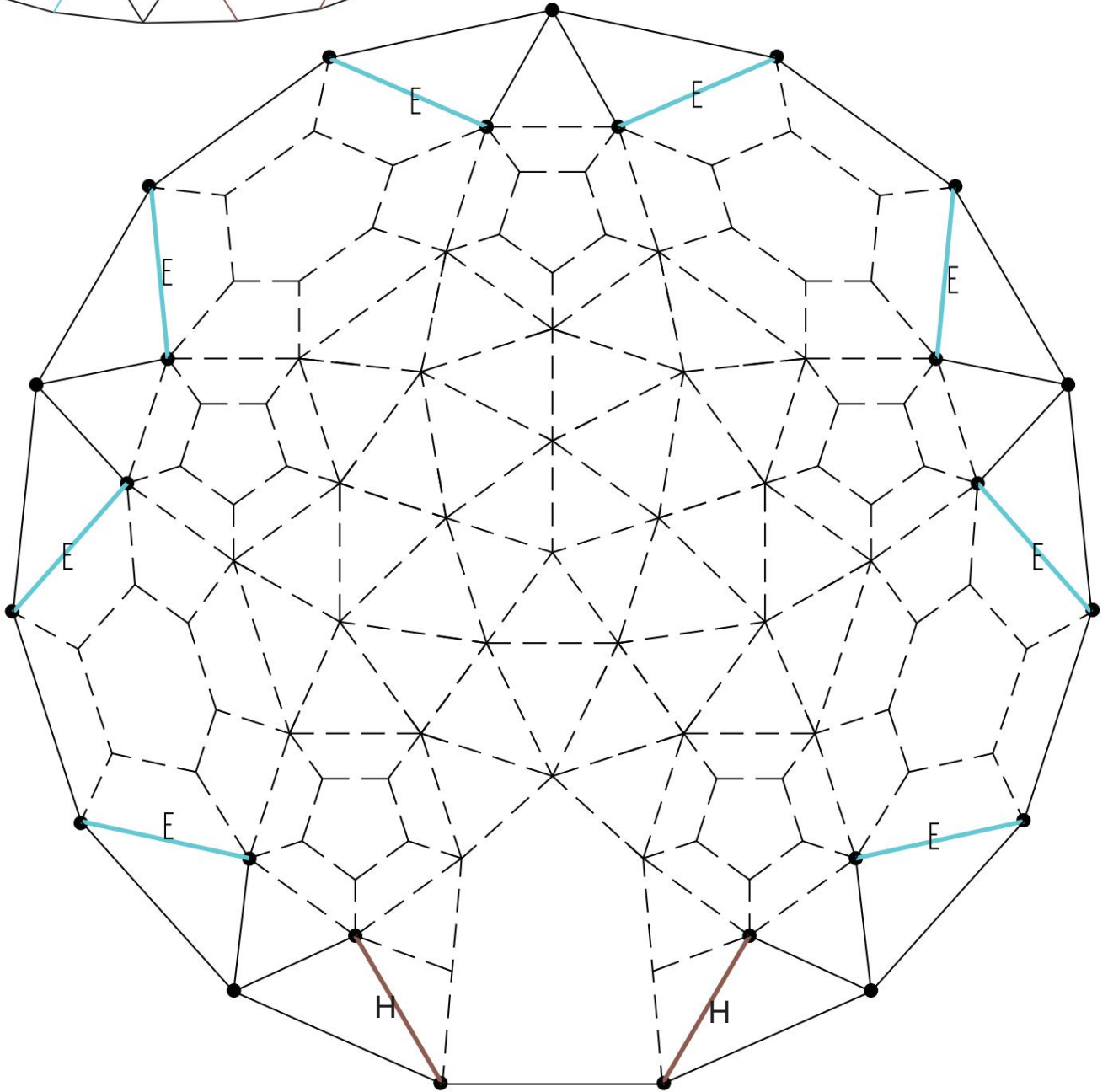
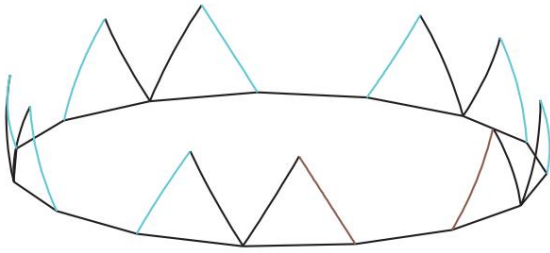

E   
8 st

H   
2 st



# Step-04

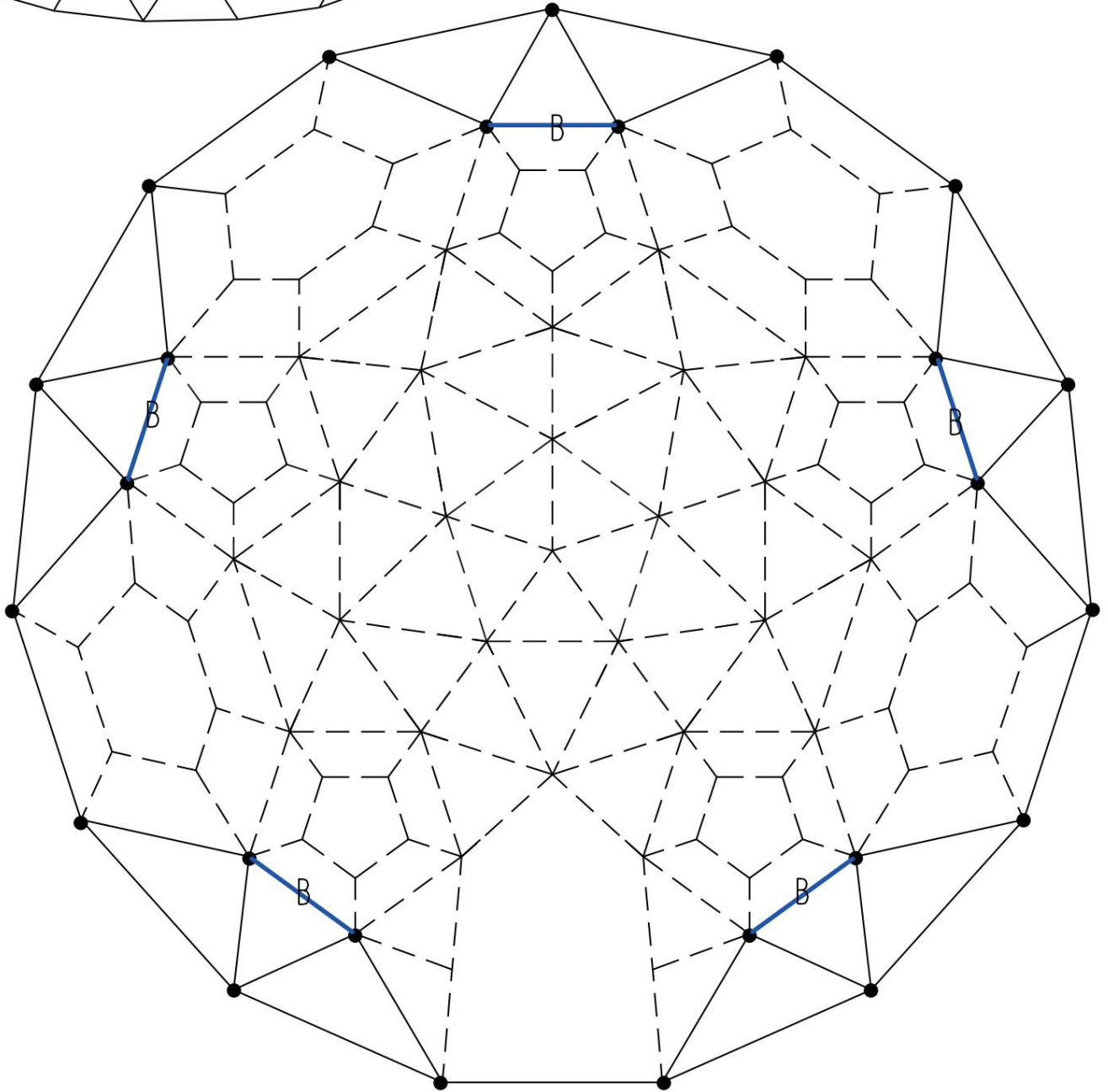
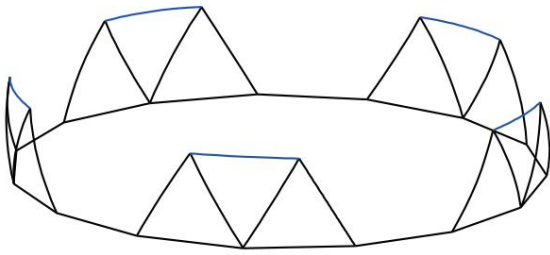

B  5 st

# Step-05

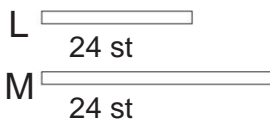
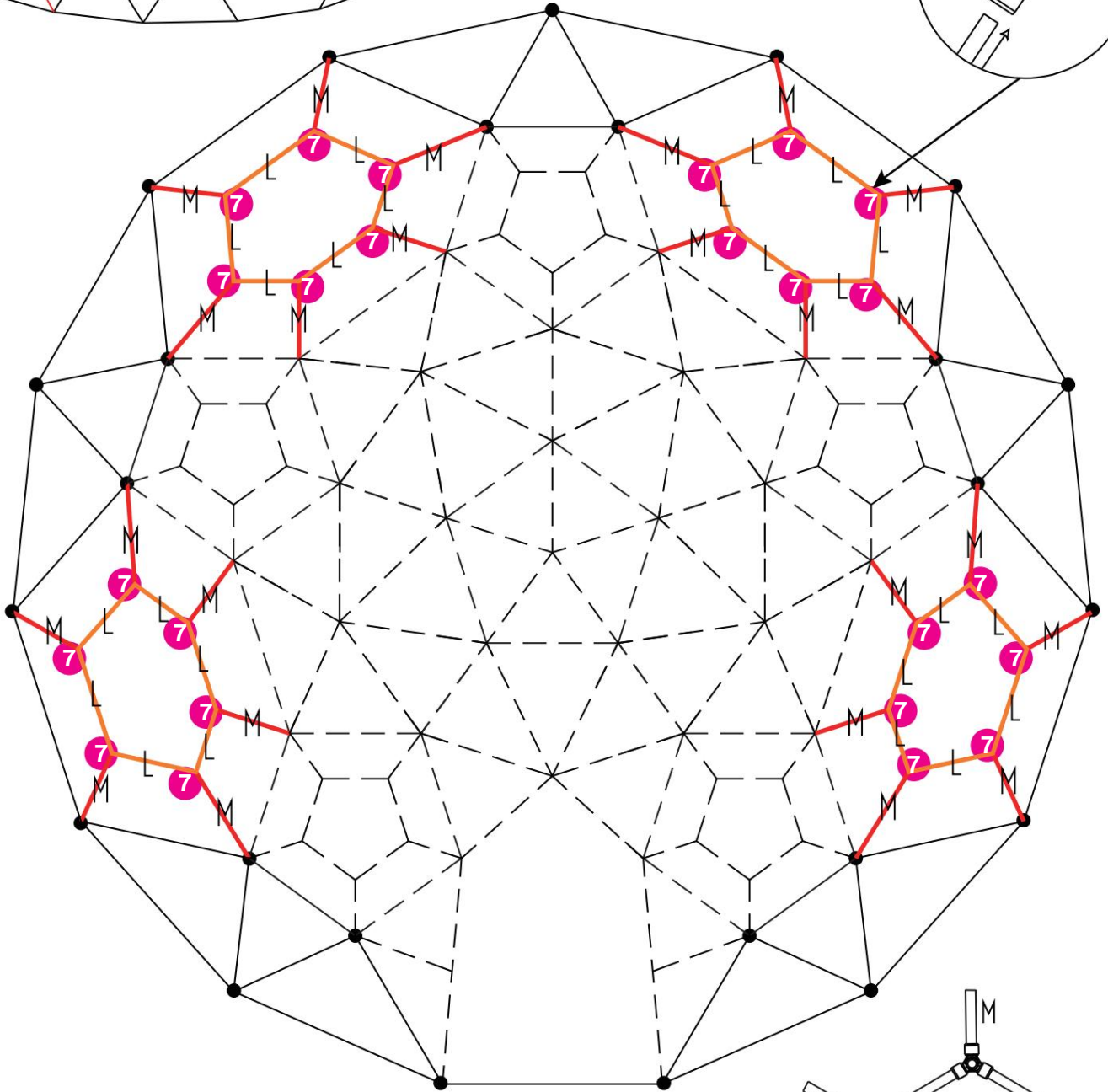
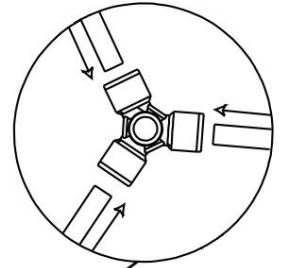
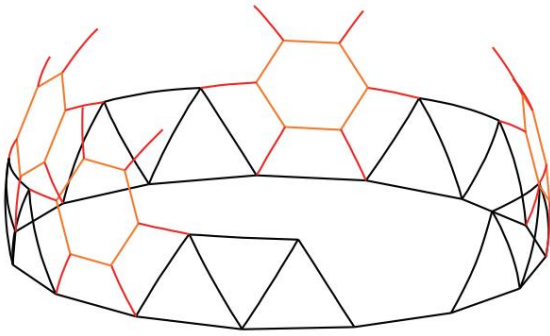

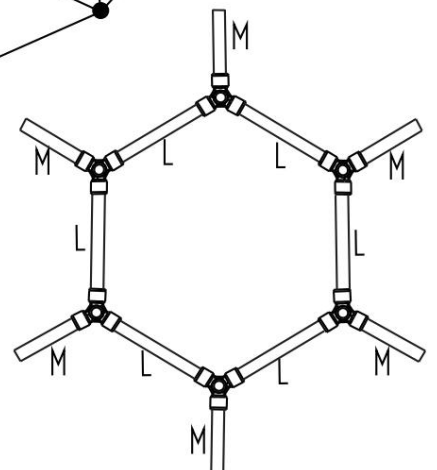

7 x24

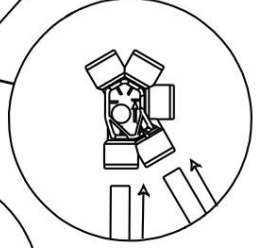
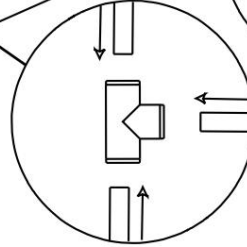
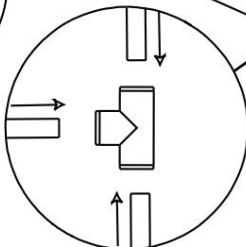
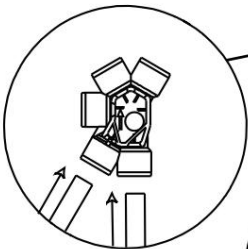
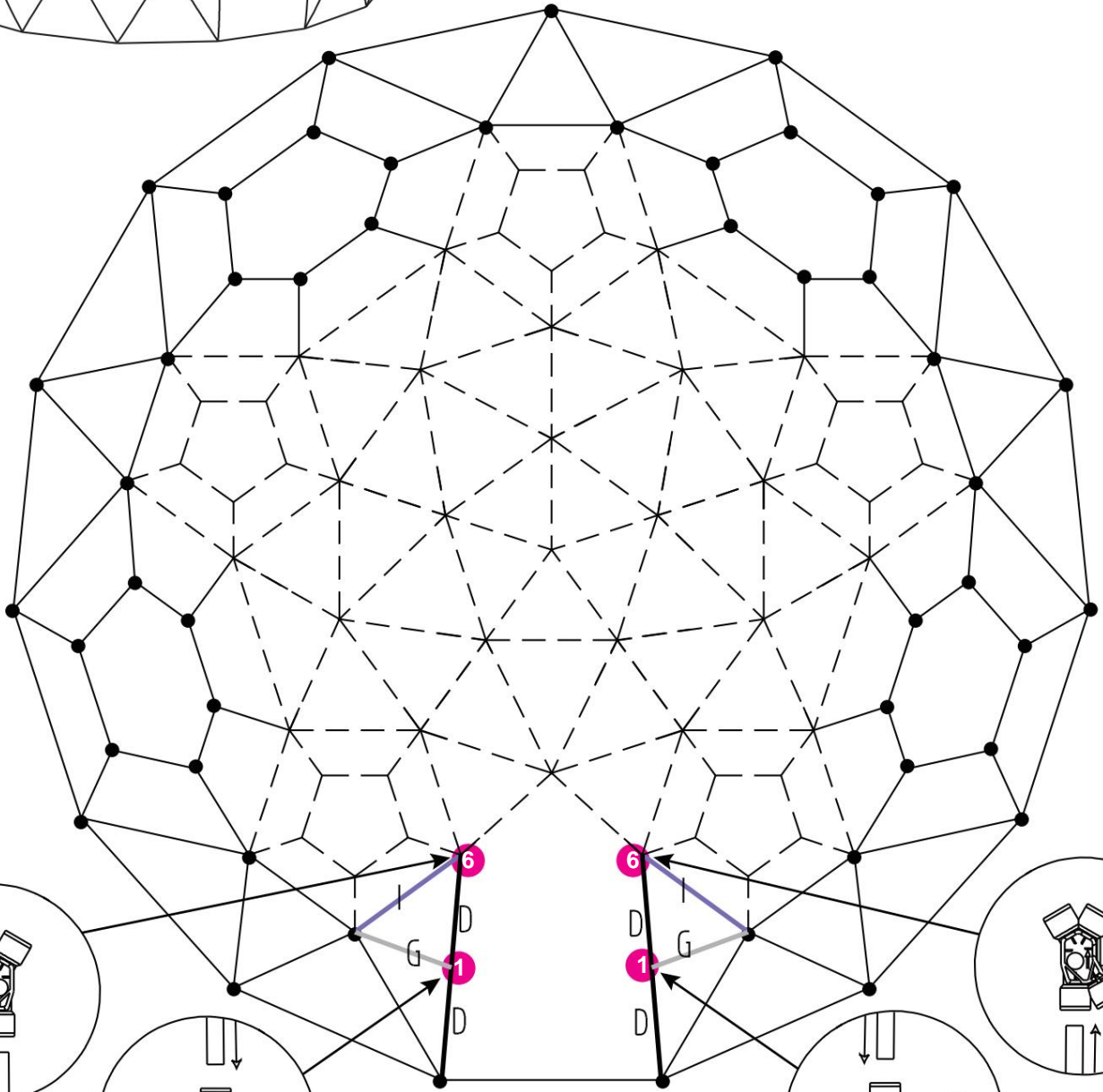
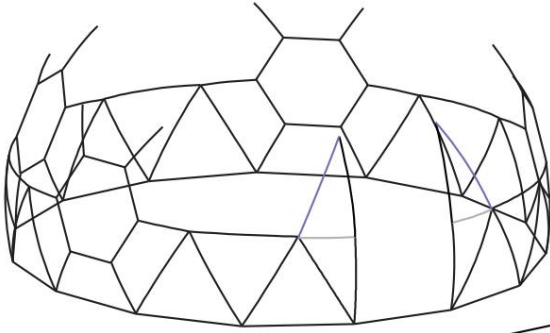

# Step-06



D  4 st

G  2 st

 2 st

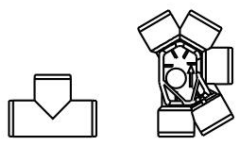

**1** x 2   **2** x 2



# Steg-07

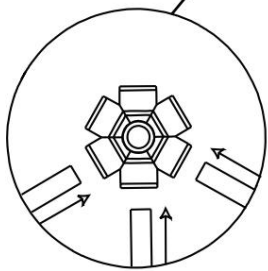
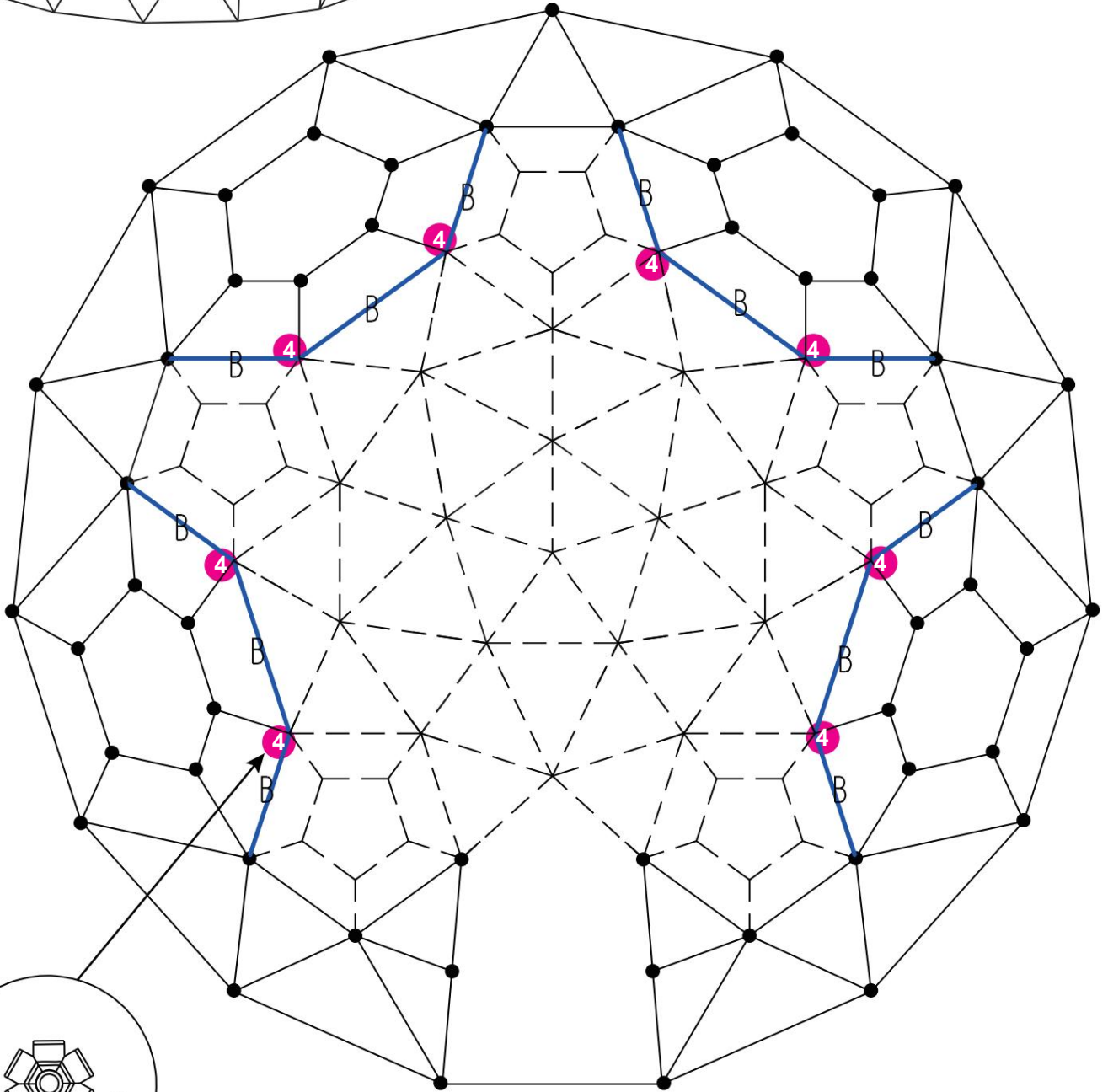
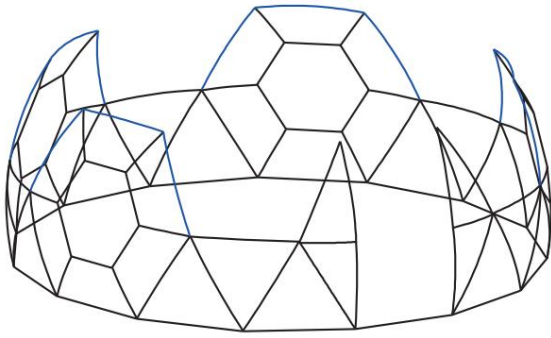

B  12 st



**4** x 8

# Step-08

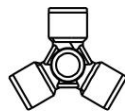
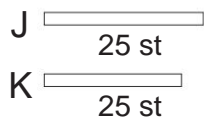
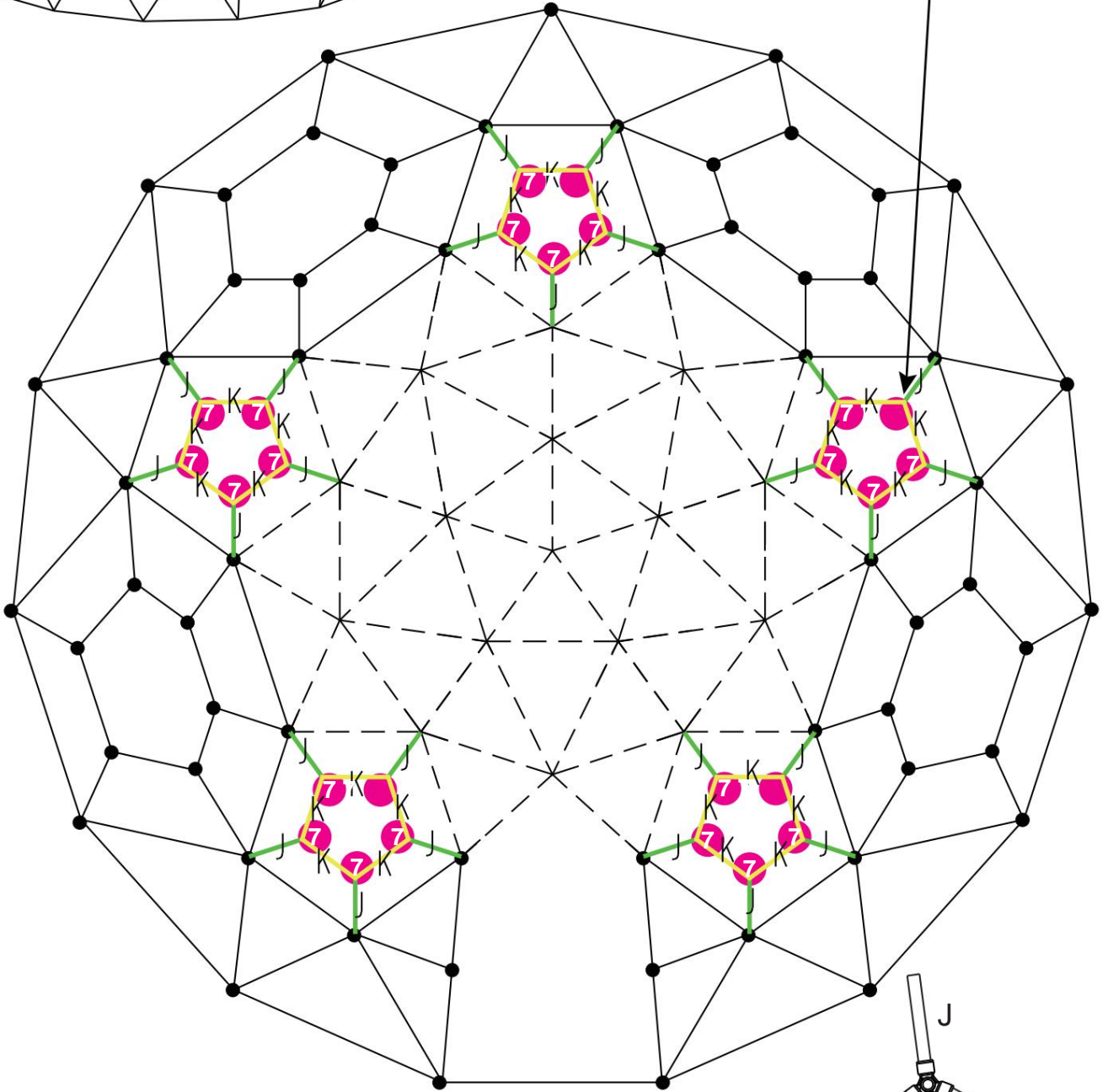
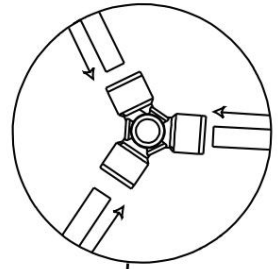
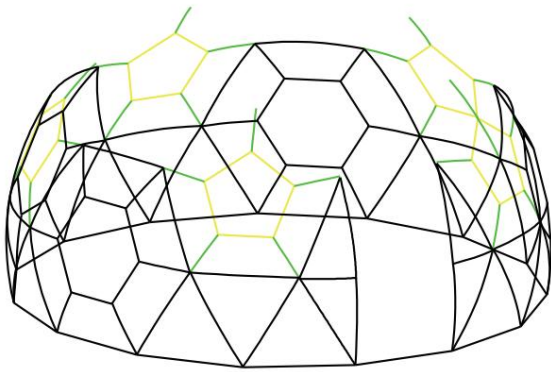

7 x 25

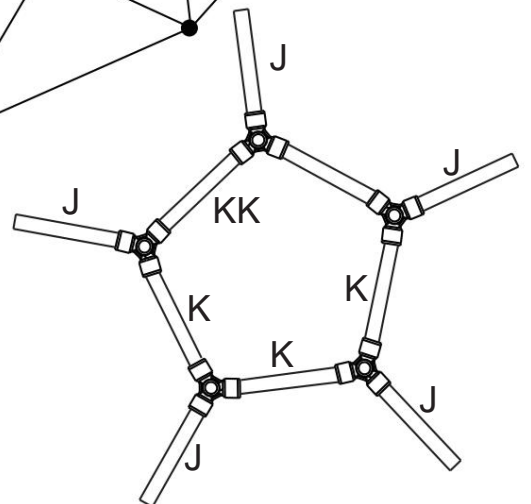

# Steg-09

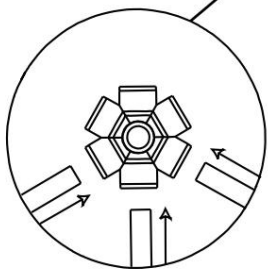
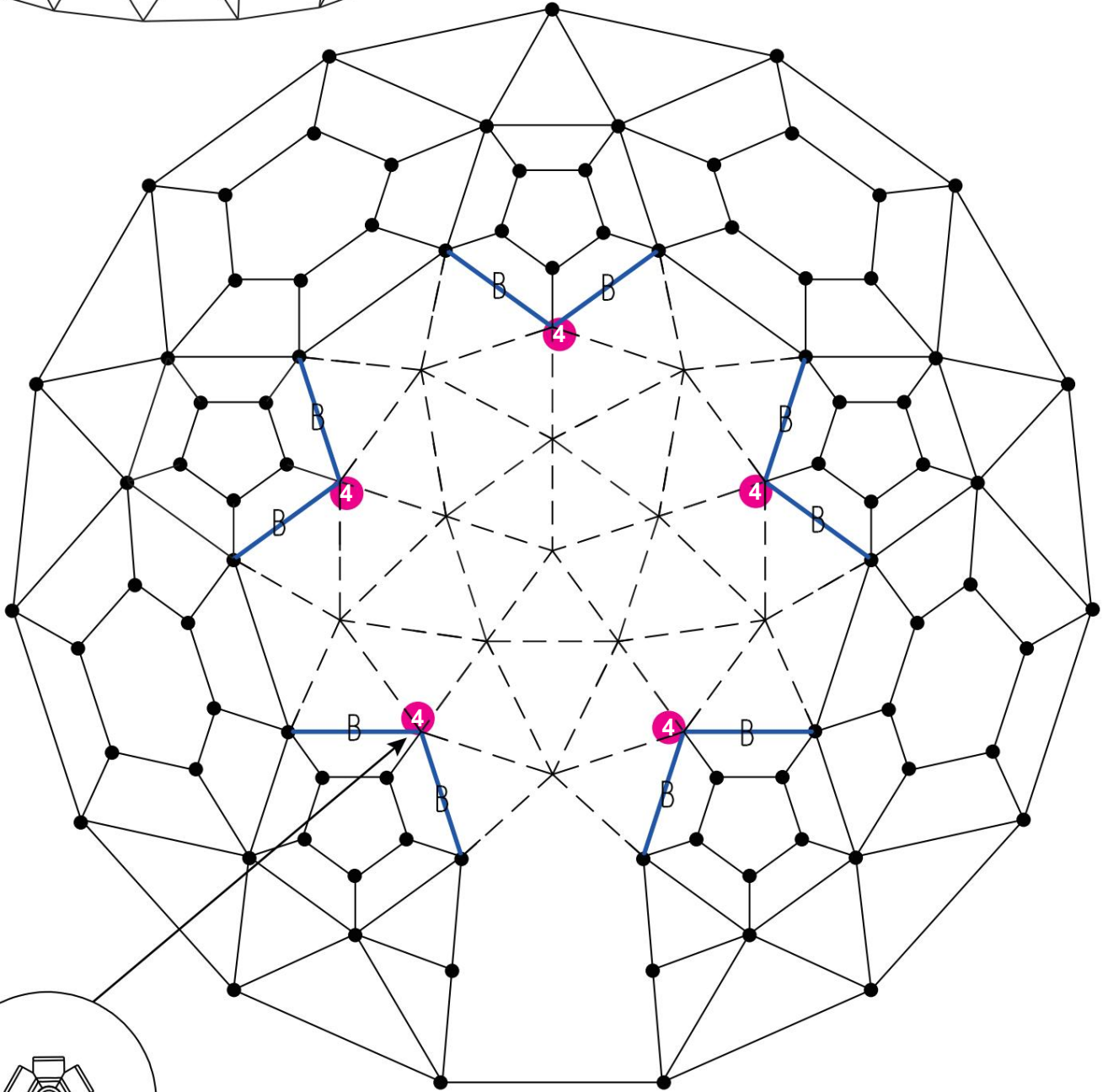
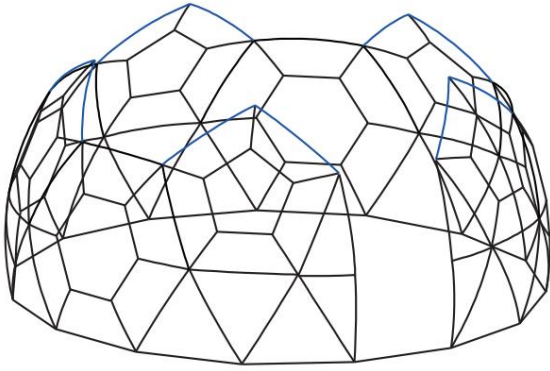

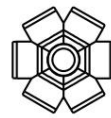

B  10 st

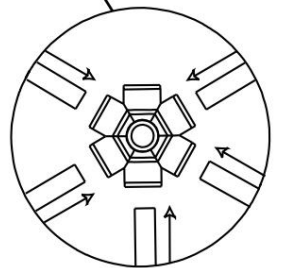
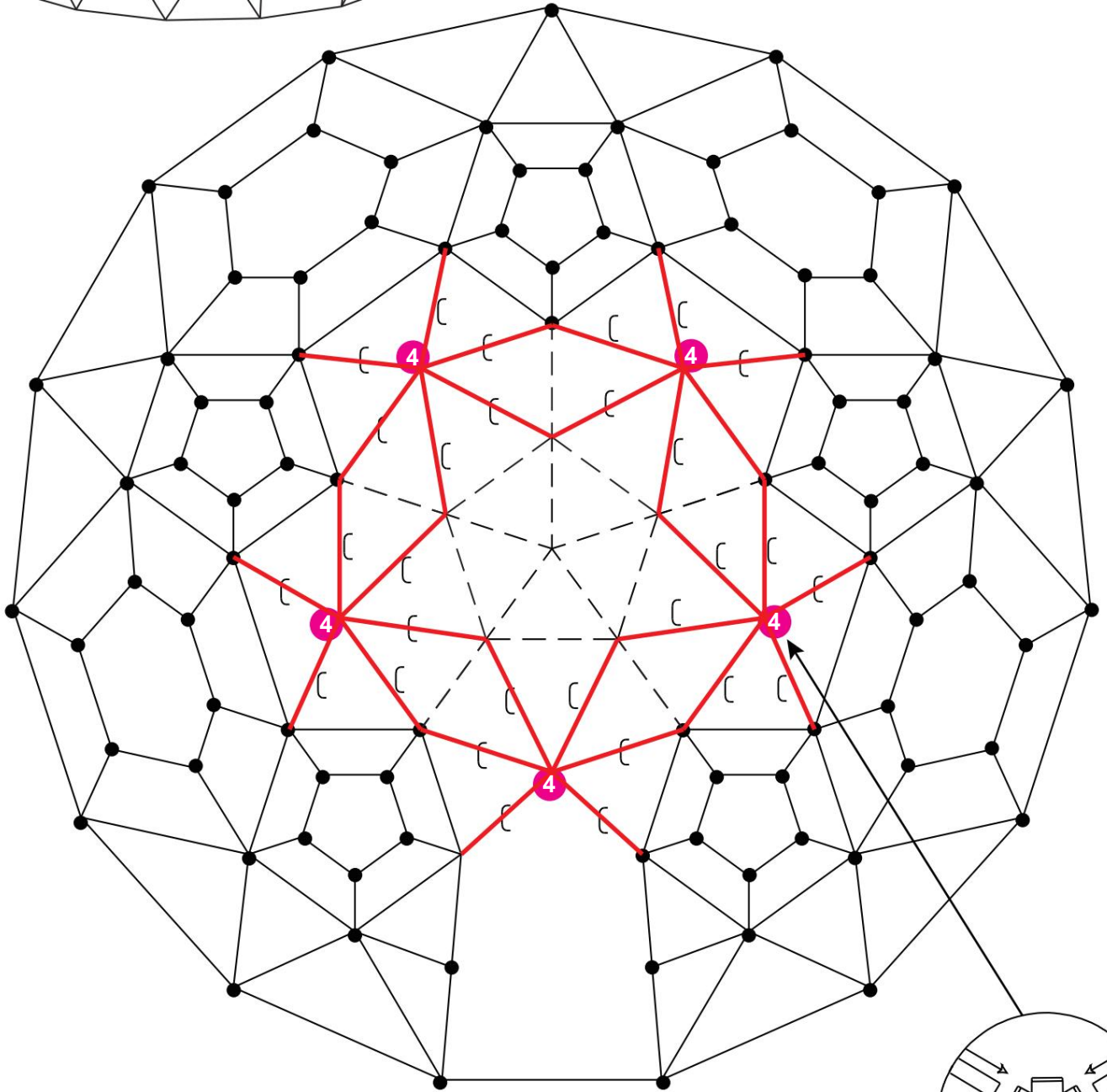
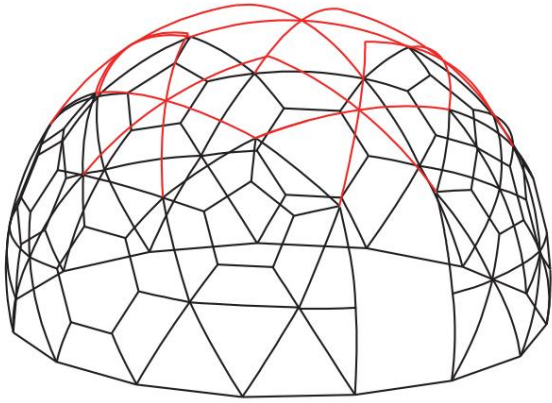

4 x5

# Step-10



C   
71 cm / 30 st

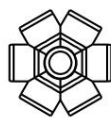

4 x5

# Step-11

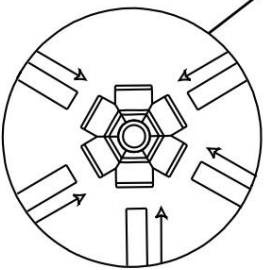
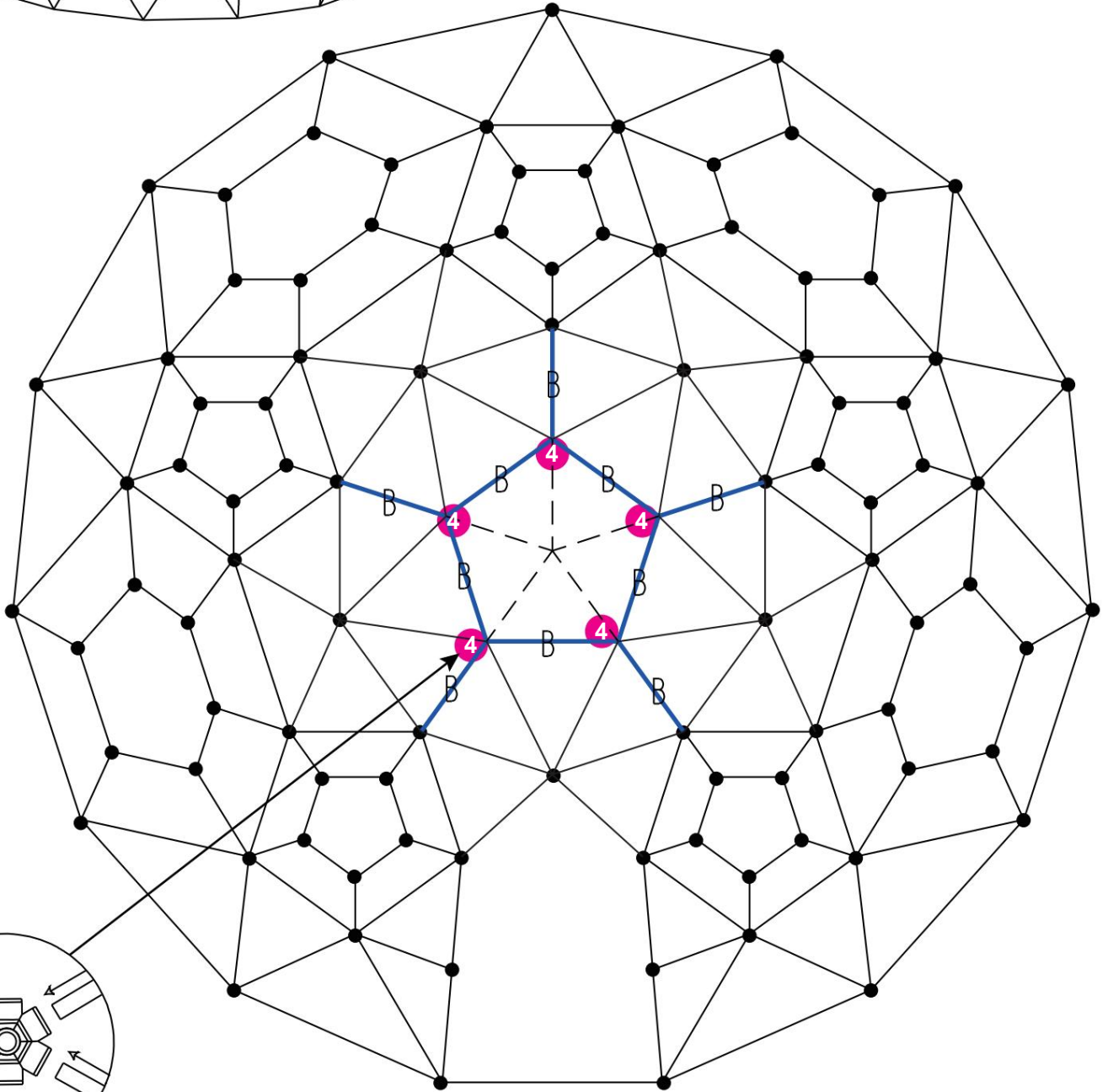
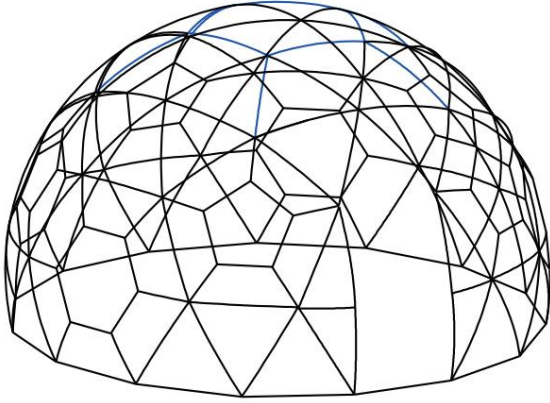

B   
10 st

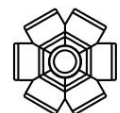

4 x 5

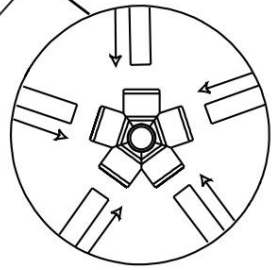
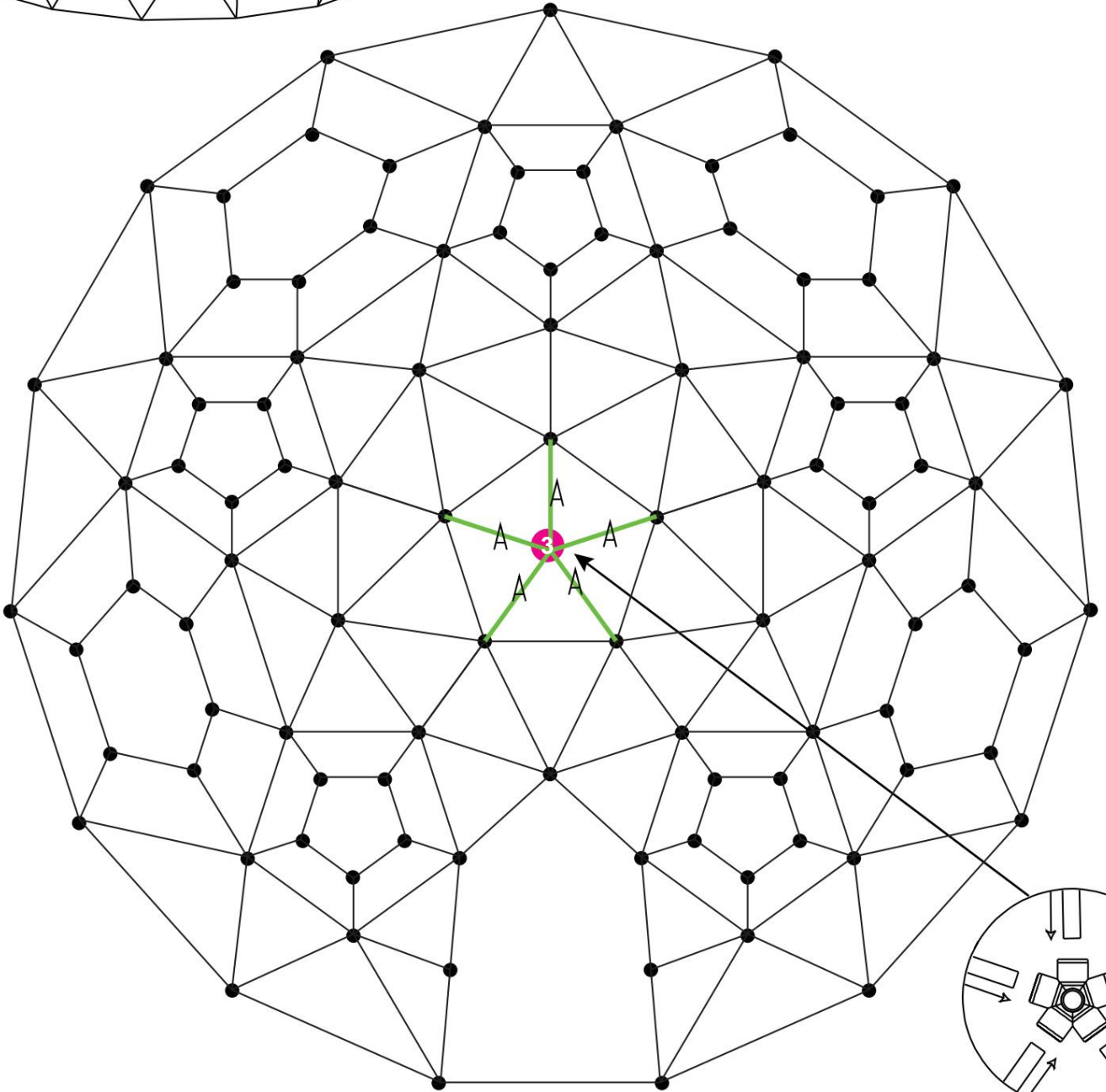
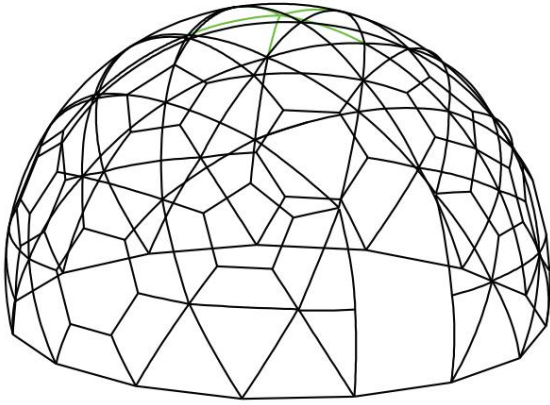

A  5 st



3 x 1

# Steg-13

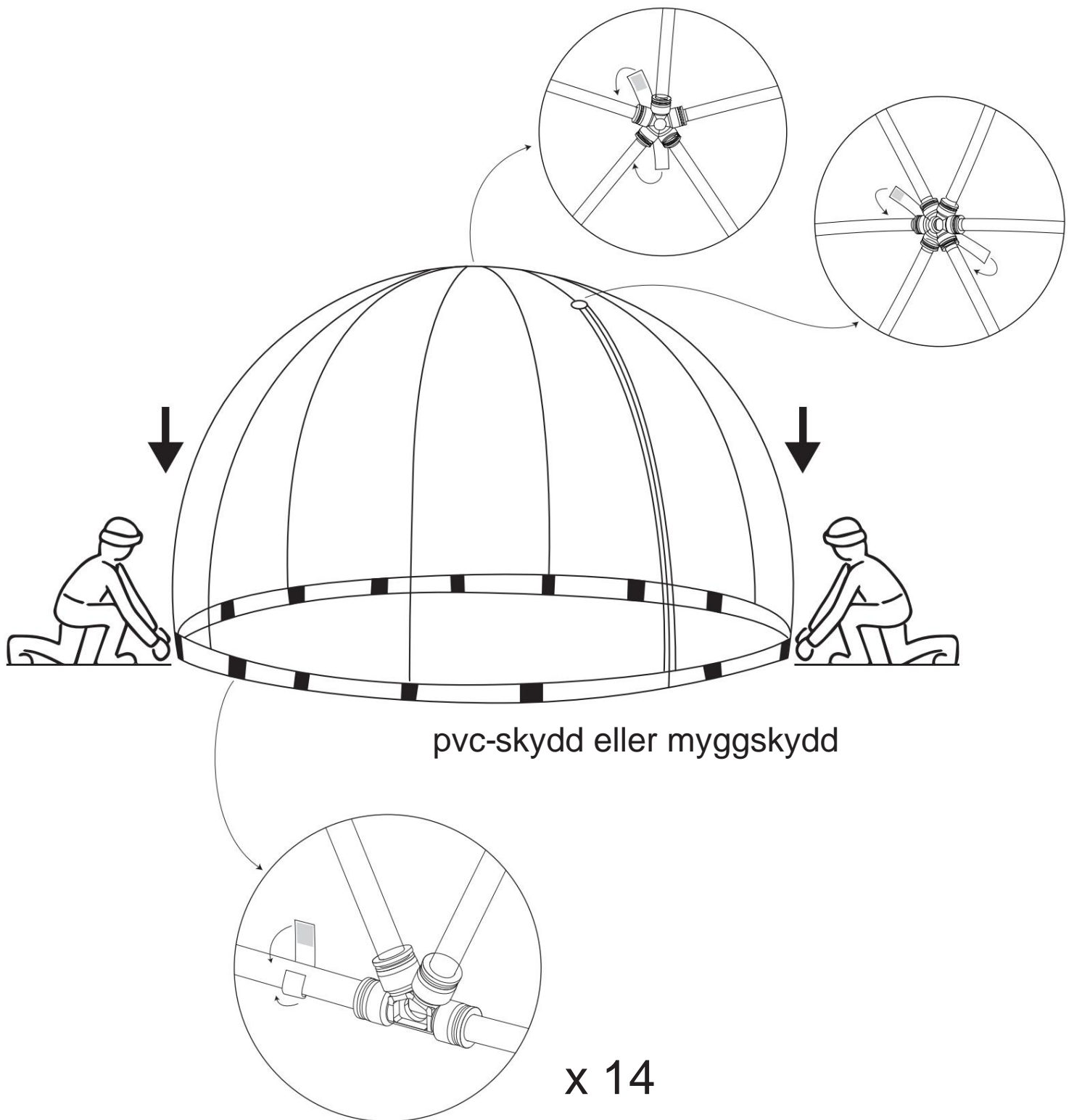

# Steg-14

## Alternativ 1

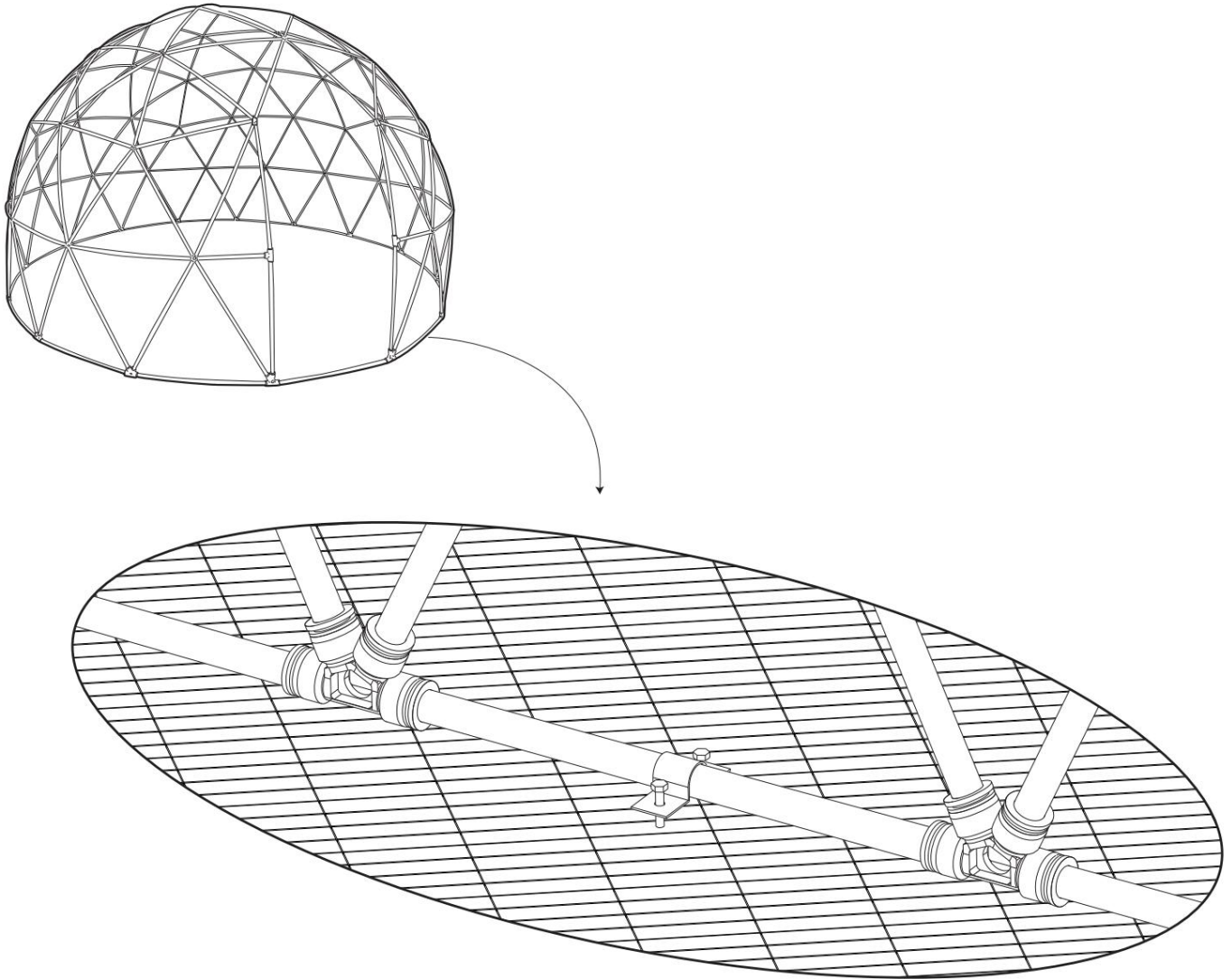

Installera på trä-/wpc-golvet

# Steg-15

## Alternativ 2

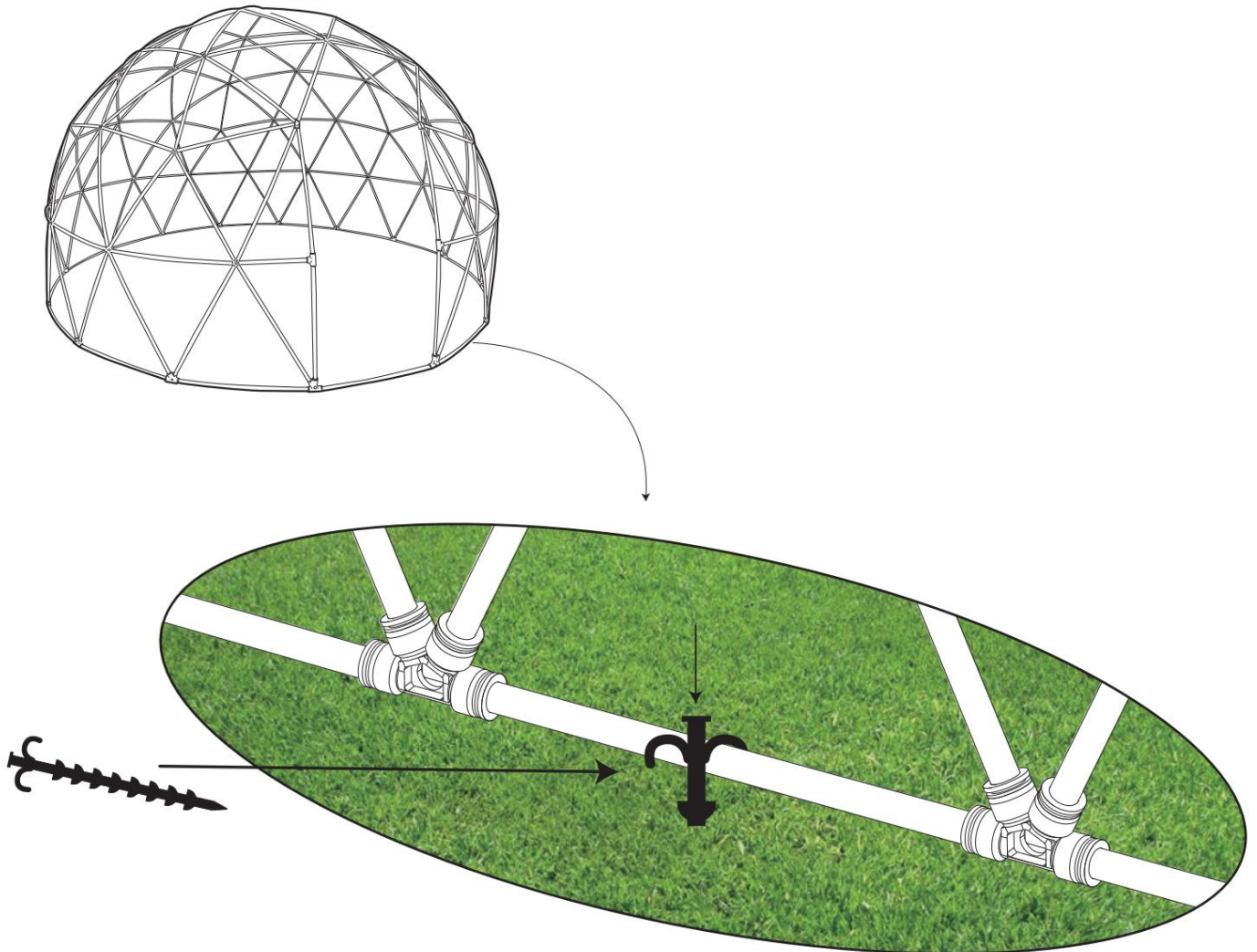

Installera på gräsgolvet

Alternativ 3: sandsäck

Varning: för att undvika  
vindbrott krävs sandsäck, 14 st

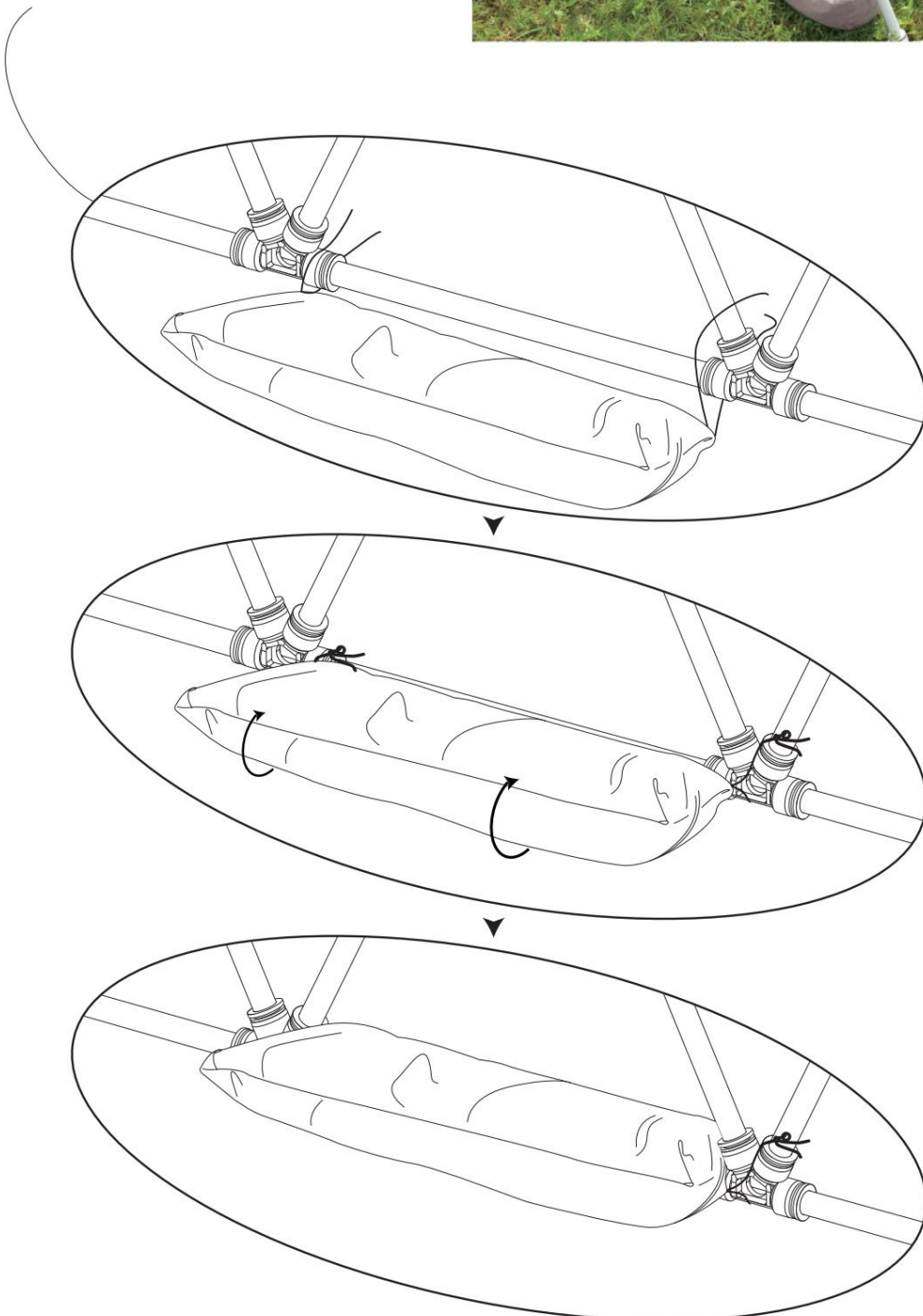
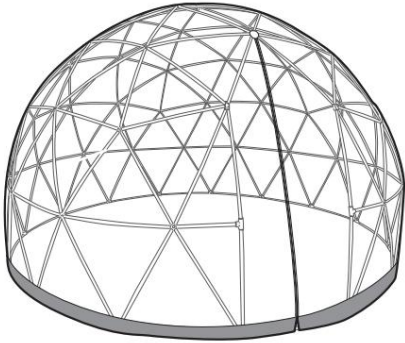

# Steg-17

Tips:

PVC-höljet kommer att ha små skrynkliga efter den första monteringen. Att vistas under solen i ungefär en timme kommer att förbättra rynkor.

 **VARNING**

**HÅLL ALLA LÅGA OCH VÄRMEKÄLLOR  
BORTA FRÅN DET HÄR KUPPTYG**

**Manufacturer:**Shanghaimuxinmuyeyouxiangongsi

**Address:** Shuangchenglu 803nong11hao1602A-1609shi, baoshanqu, shanghai 200000 CN.

**Imported to AUS:** SIHAO PTY LTD. 1 ROKEVA STREETEASTWOOD NSW 2122 Australia

**Imported to USA:** Sanven Technology Ltd. Suite 250, 9166 Anaheim Place, Rancho Cucamonga, CA 91730



E-CrossStu GmbH  
Mainzer Landstr.69, 60329 Frankfurt am Main.



YH CONSULTING LIMITED.  
C/O YH Consulting Limited Office 147, Centurion House,  
London Road, Staines-upon-Thames, Surrey, TW18 4AX



**VEVOR**<sup>®</sup>

**TOUGH TOOLS, HALF PRICE**

Technical Support and E-Warranty Certificate

[www.vevor.com/support](http://www.vevor.com/support)

# VEVOR<sup>®</sup>

## TOUGH TOOLS, HALF PRICE

Technical Support and E-Warranty Certificate [www.vevor.com/support](http://www.vevor.com/support)

### JARDÍN AL AIRE LIBRE CLARO DOOM

### MANUAL DE USUARIO

Seguimos comprometidos a proporcionarle herramientas a precios competitivos. "Ahorre a mitad de precio", "A mitad de precio" o cualquier otra expresión similar utilizada por nosotros solo representa una estimación de los ahorros que podría beneficiarse al comprar ciertas herramientas con nosotros en comparación con las principales marcas y no significa necesariamente cubrir todas las categorías de herramientas ofrecidas. por nosotros. Le recordamos que, cuando realice un pedido con nosotros, verifique cuidadosamente si realmente está ahorrando la mitad en comparación con las principales marcas.

**VEVOR**<sup>®</sup>  
TOUGH TOOLS, HALF PRICE

JARDÍN EXTERIOR CLARO  
CONDENAR

Model: GB-DOME-12, GB-DOME-12T, GB-DOME-9.5 GB-DOME-9.5T

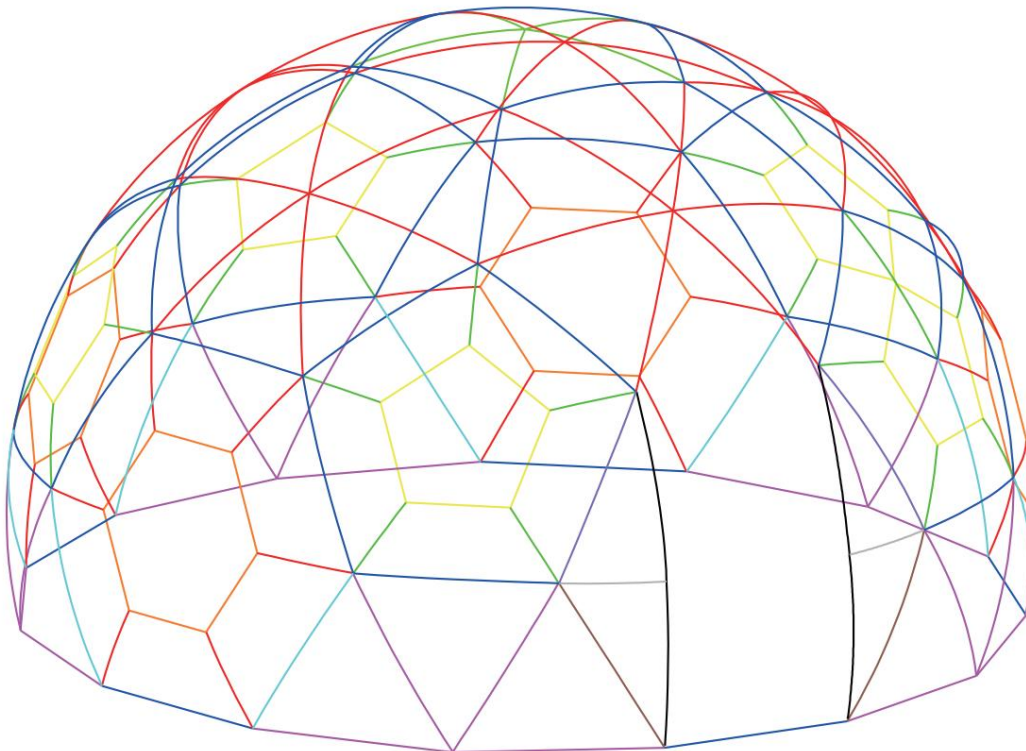

¿NECESITAS AYUDA? ¡CONTÁCTENOS!

¿Tiene preguntas sobre el producto? ¿Necesita soporte técnico? No dude en contactarnos:  
Soporte técnico y certificado de garantía electrónica [www.vevor.com/support](http://www.vevor.com/support)

Estas son las instrucciones originales; lea atentamente todas las instrucciones del manual antes de operar. VEVOR se reserva una interpretación clara de nuestro manual de usuario. La apariencia del producto estará sujeta al producto que recibió. Perdón que no le informaremos nuevamente si hay actualizaciones de tecnología o software en nuestro producto.

## ESPECIFICACIONES

Modelo	GB-DOME-12
Tamaño del producto	12 pies
Color	Transparente
Capacidad de carga	110 libras

Modelo	GB-DOME-12T
Tamaño del producto	12 pies
Color	Transparente
Capacidad de carga	110 libras

Modelo	GB-DOME-9.5
Tamaño del producto	9,5 pies
Color	Transparente
Capacidad de carga	110 libras





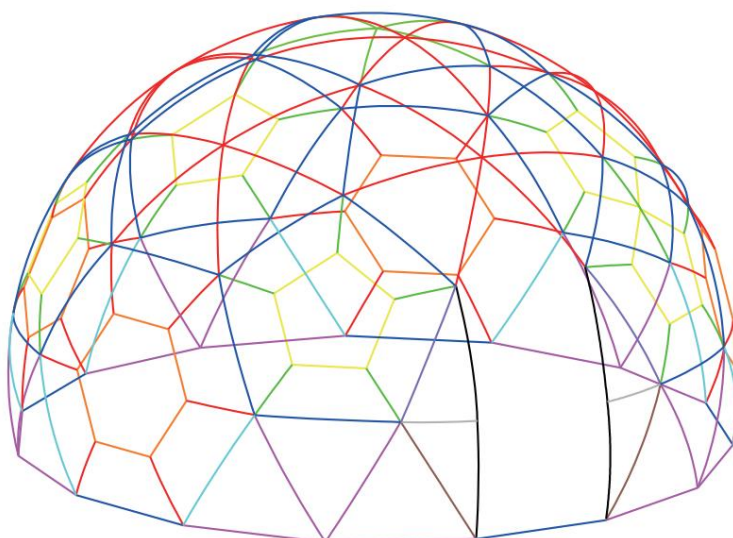

Modelo	GB-DOME-9.5T
Tamaño del producto	9,5 pies
Color	Transparente
Capacidad de carga	110 libras

# Accesorios

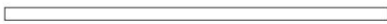
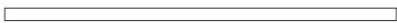
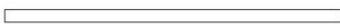
Modelo	Cubierta transparente de PVC	Cubierta contra mosquitos
GB-DOME-12	✓	✗
GB-DOME-12T	✓	✓
GB-DOME-9.5	✓	✗
GB-DOME-9.5T	✓	✓

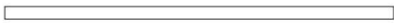

Tuberías :

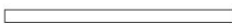
- A  5 piezas
- B  42 piezas
- C  50 pcs
- D  4 piezas
- mi  8 piezas
-  2 piezas
- GRAMO
- h  2 piezas
- l  2 piezas
- j  25 piezas
- k  25 piezas
- l  24 piezas
- METRO
-  24 piezas

Cubrir:

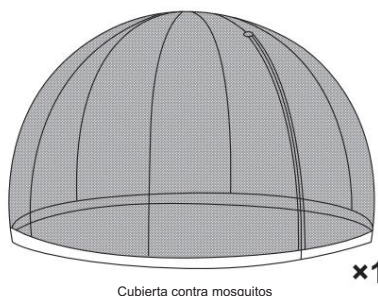
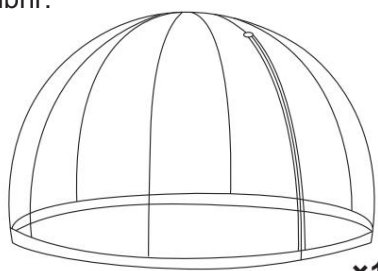

Evaluaciones estándar:

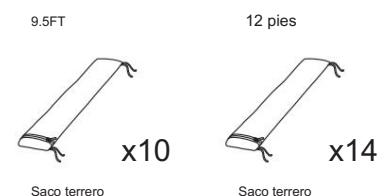
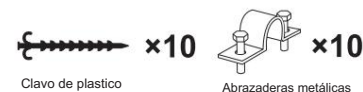

Conectores:

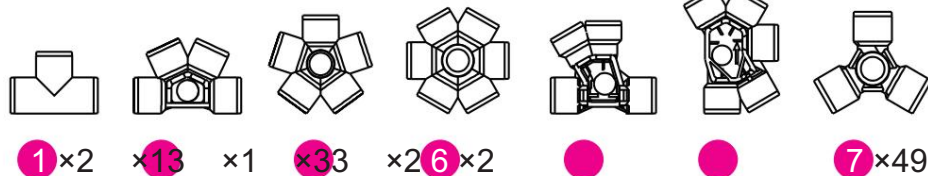

# Paso-01

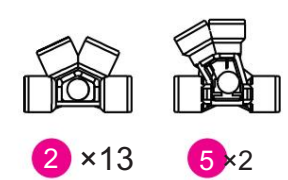
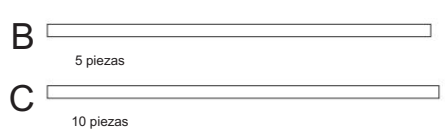
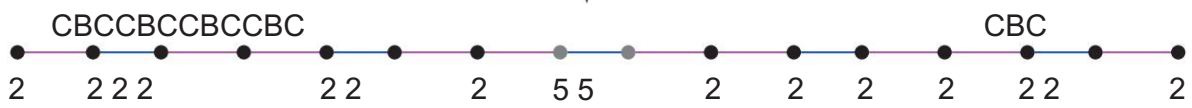
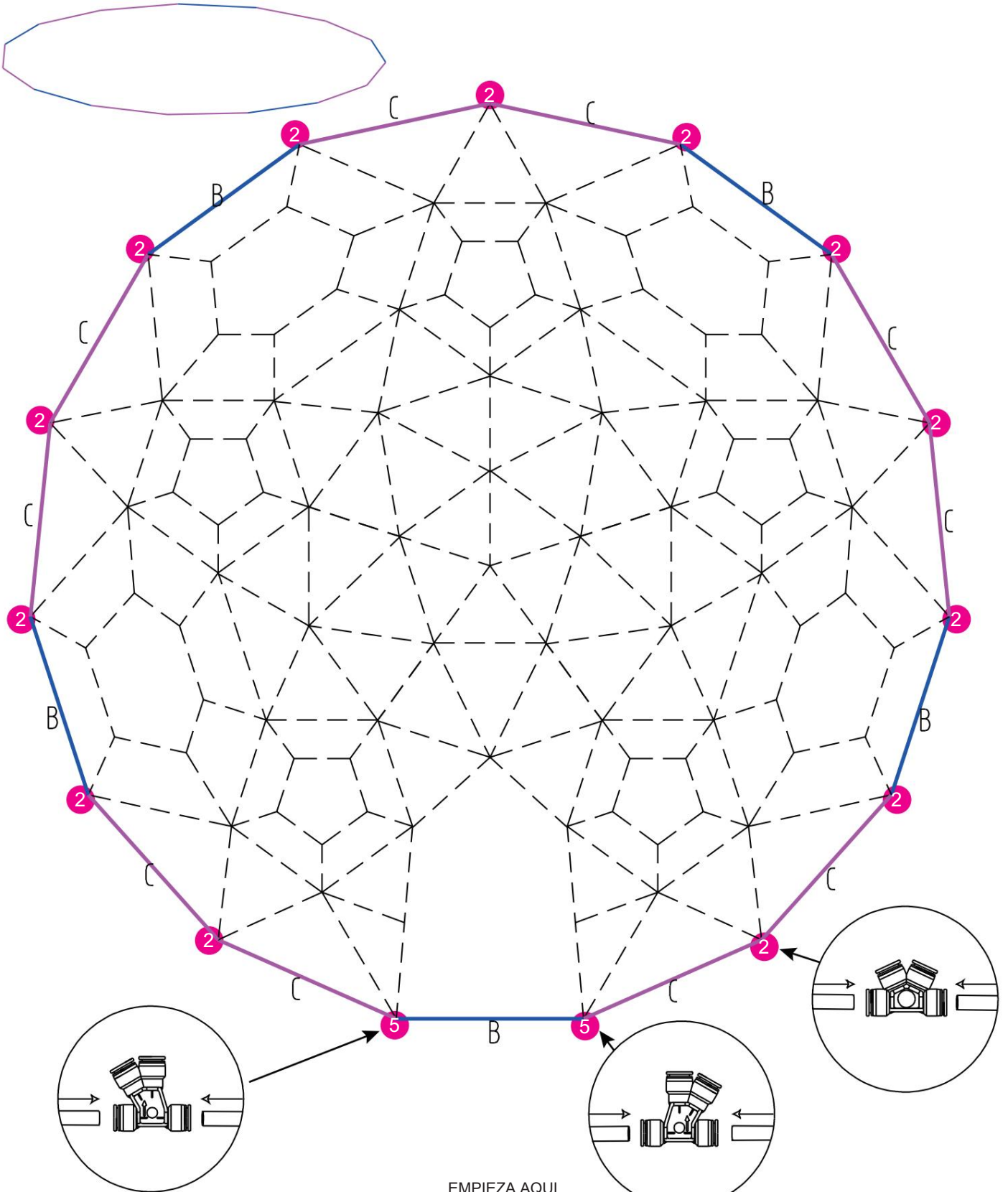

# Paso-02

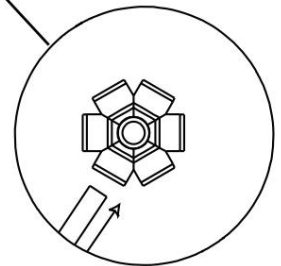
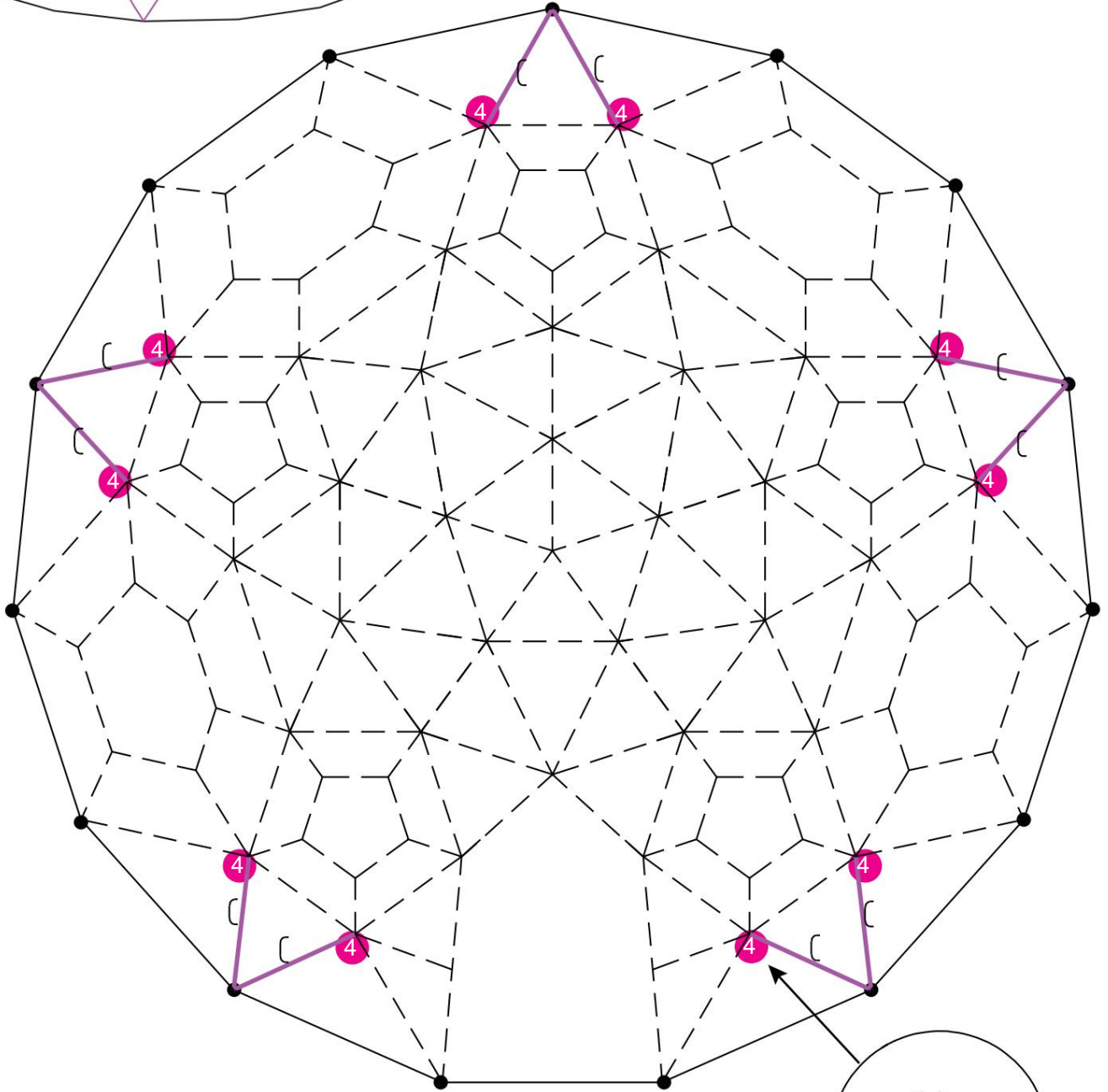
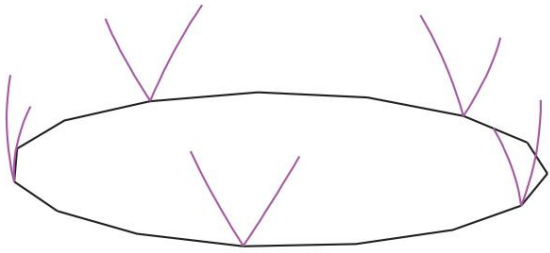

C   
10 piezas

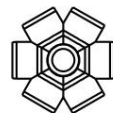

4 x 10

# Paso-03

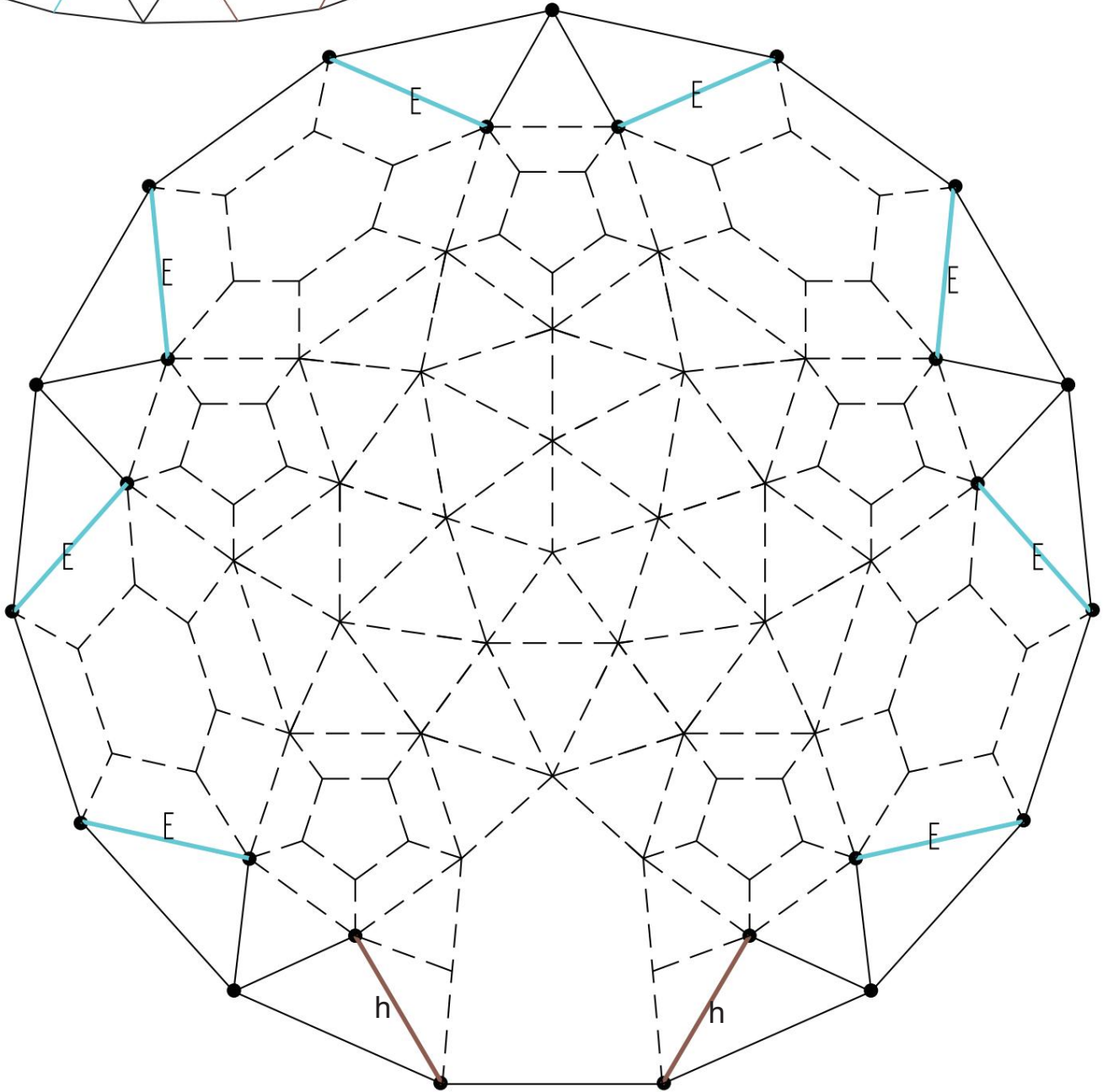
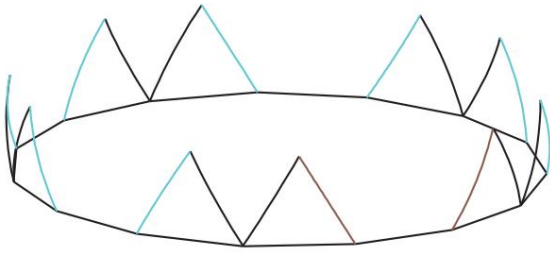

mi   
8 piezas

h   
2 piezas



# Paso-04

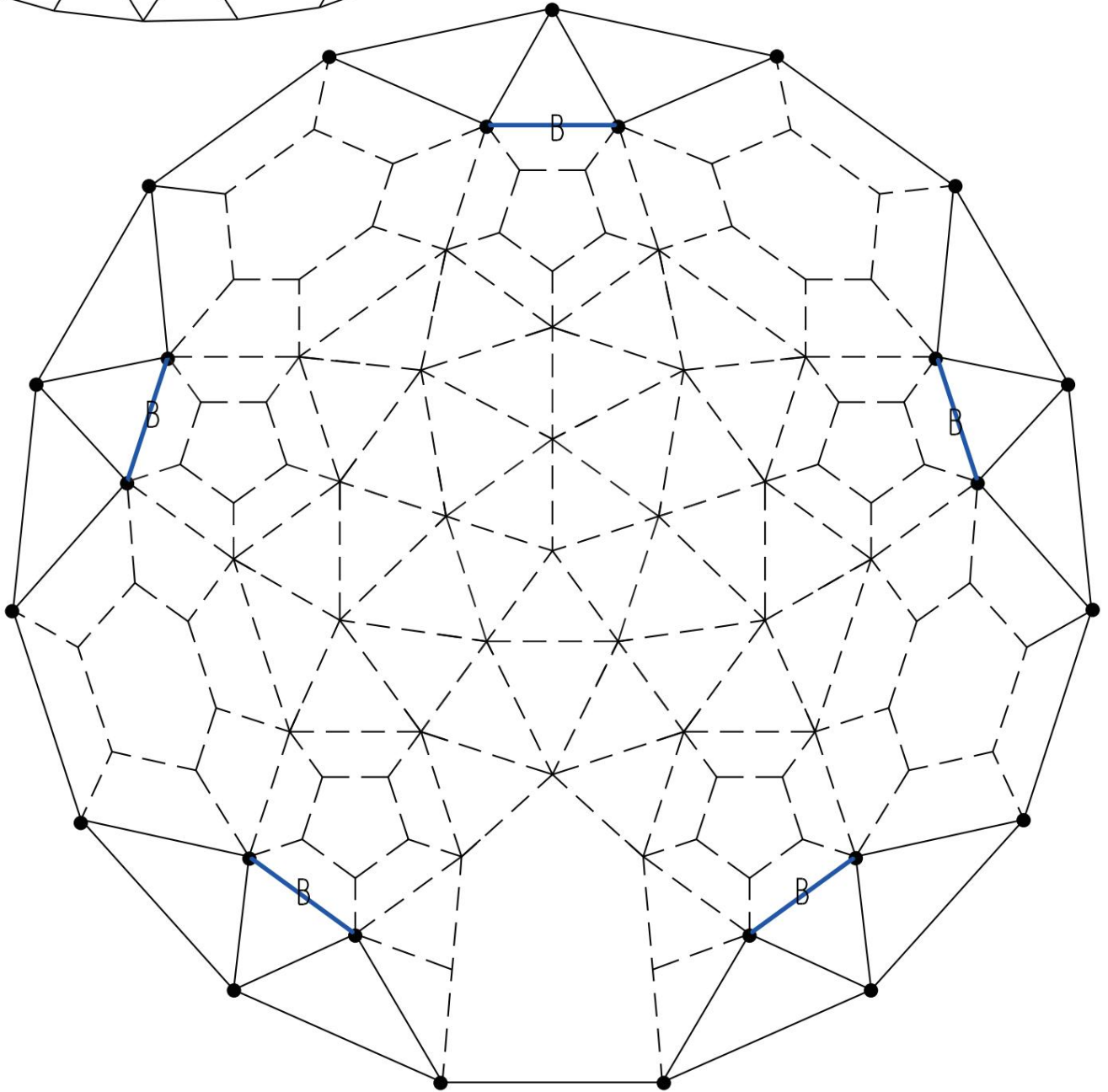
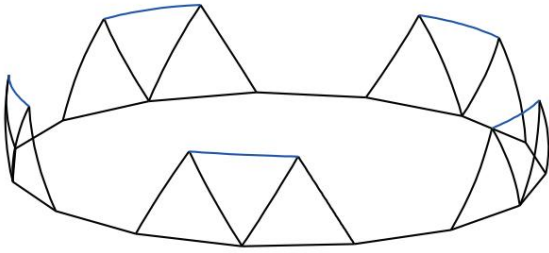

B   
5 piezas



# Paso-05

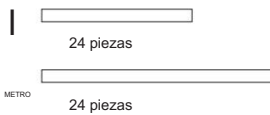
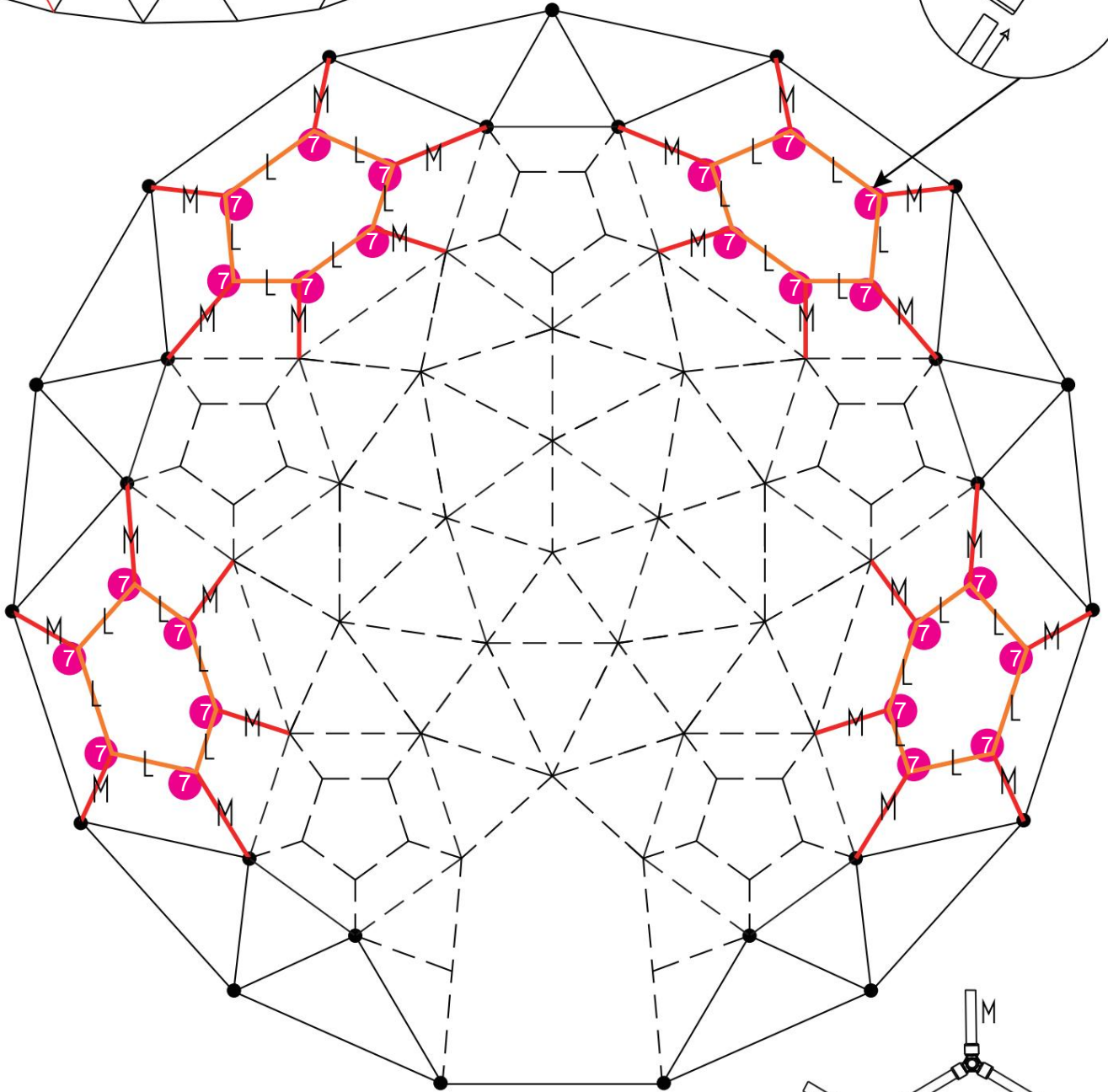
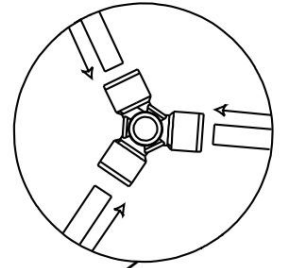
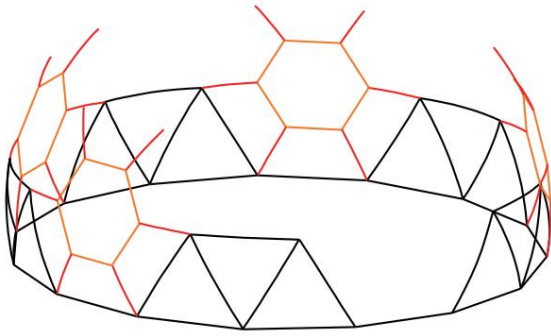

7 x 24

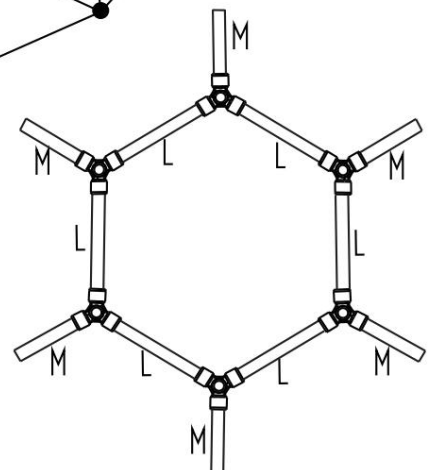

# Paso-06

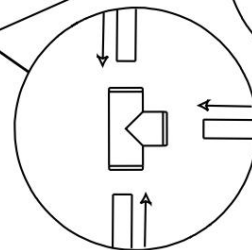
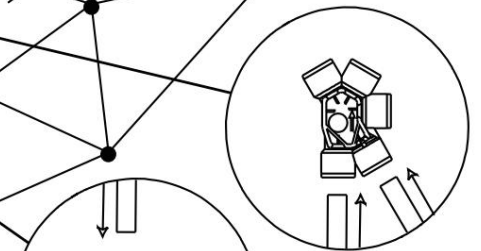
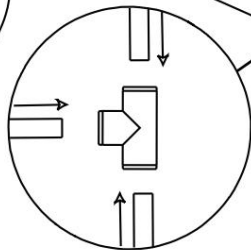
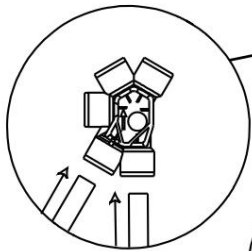
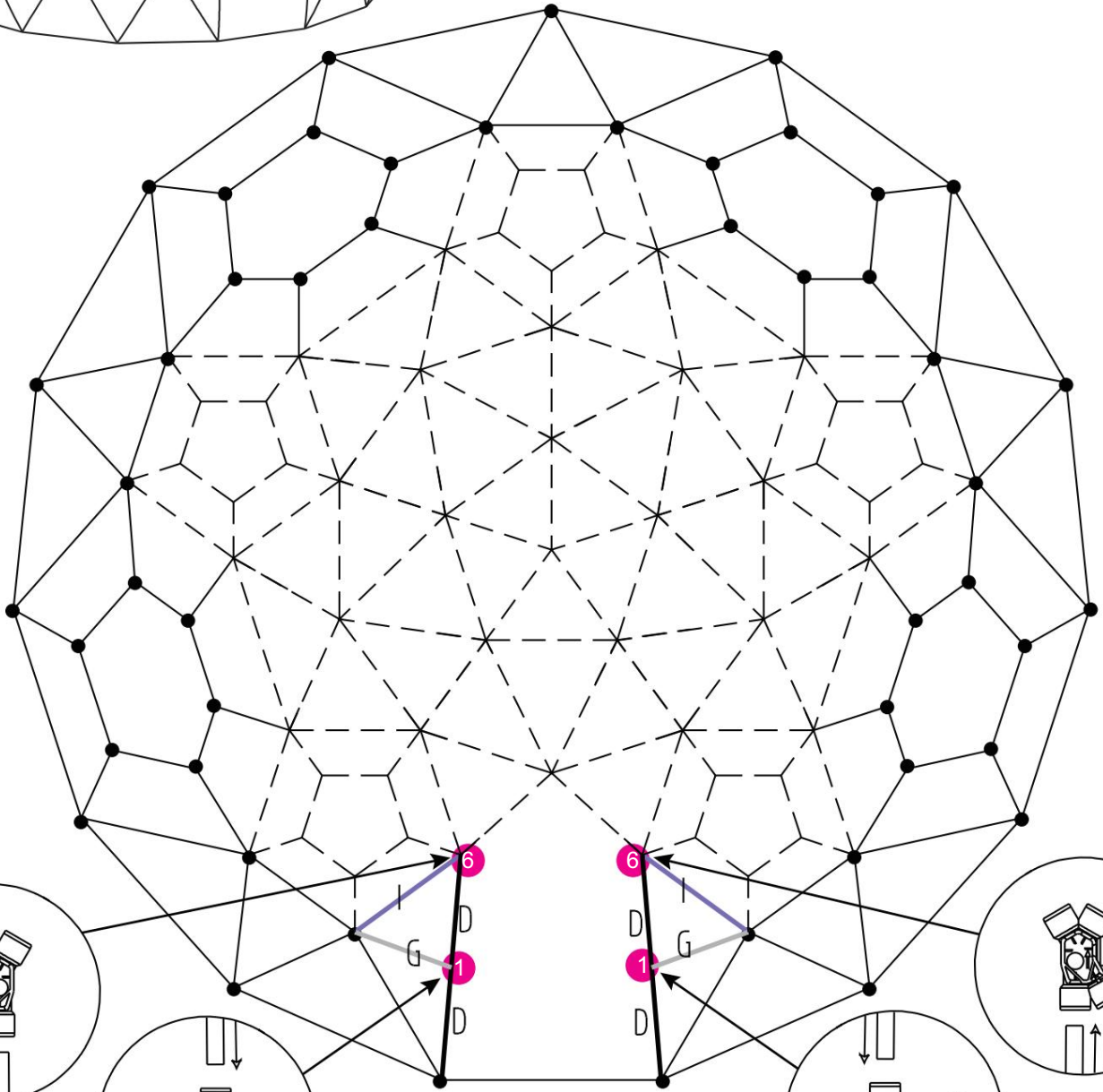
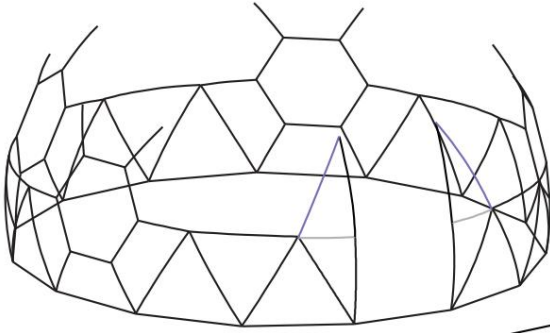

D   
4 piezas

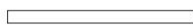
GRAMO   
2 piezas

I   
2 piezas

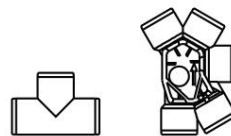

1 x 2 x 2

# Paso-07

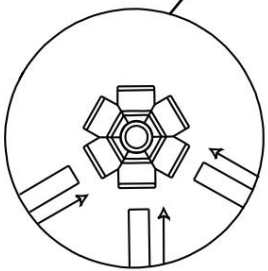
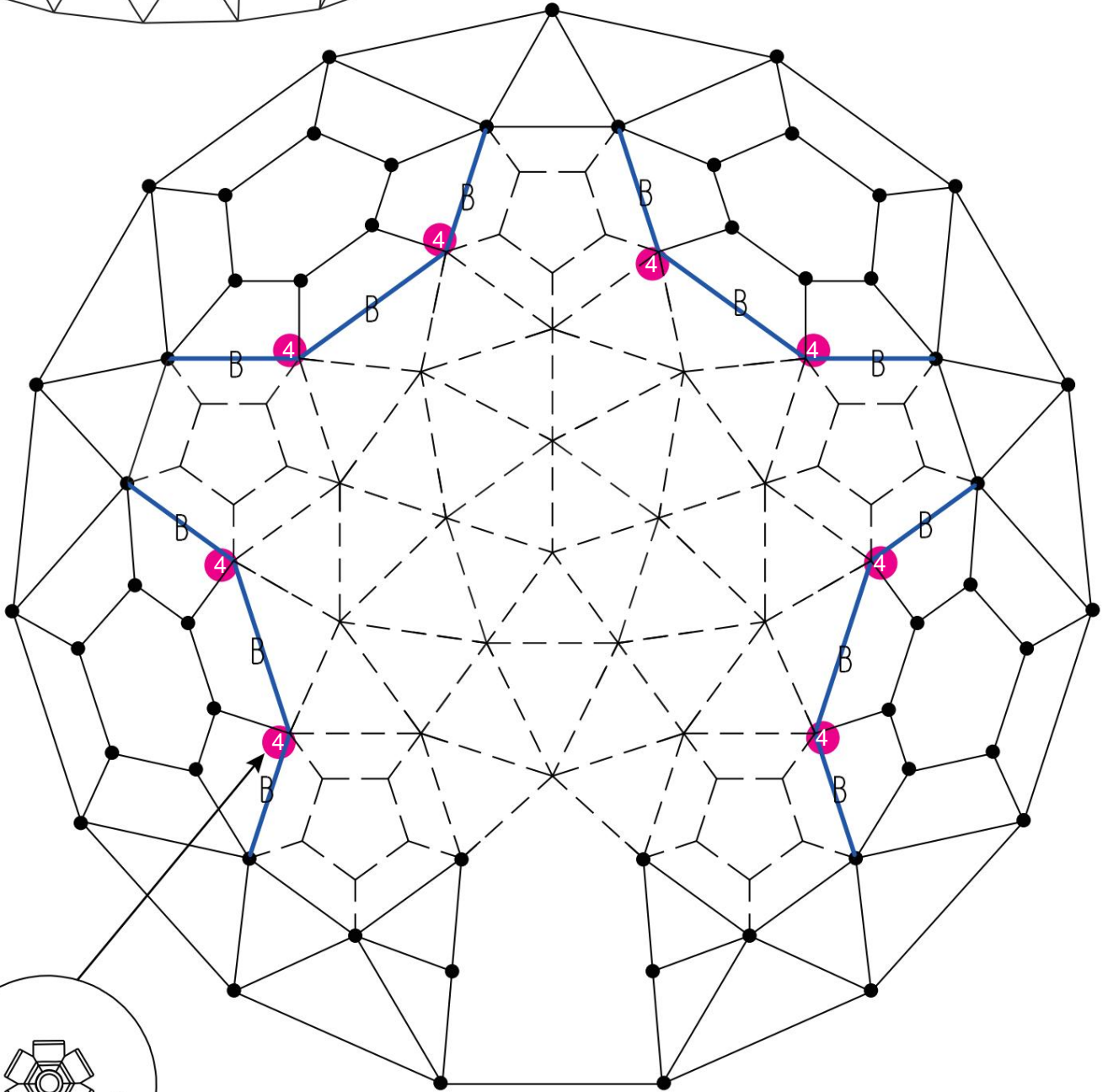
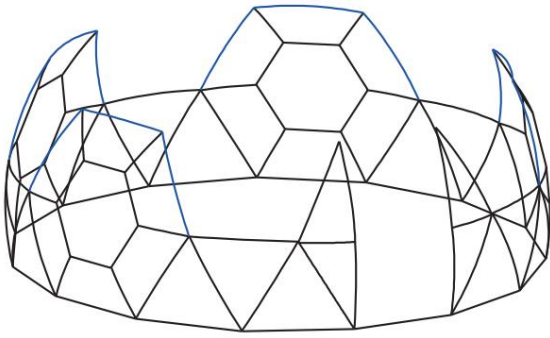

B  12 piezas



4 x 8

# Paso-08

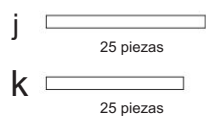
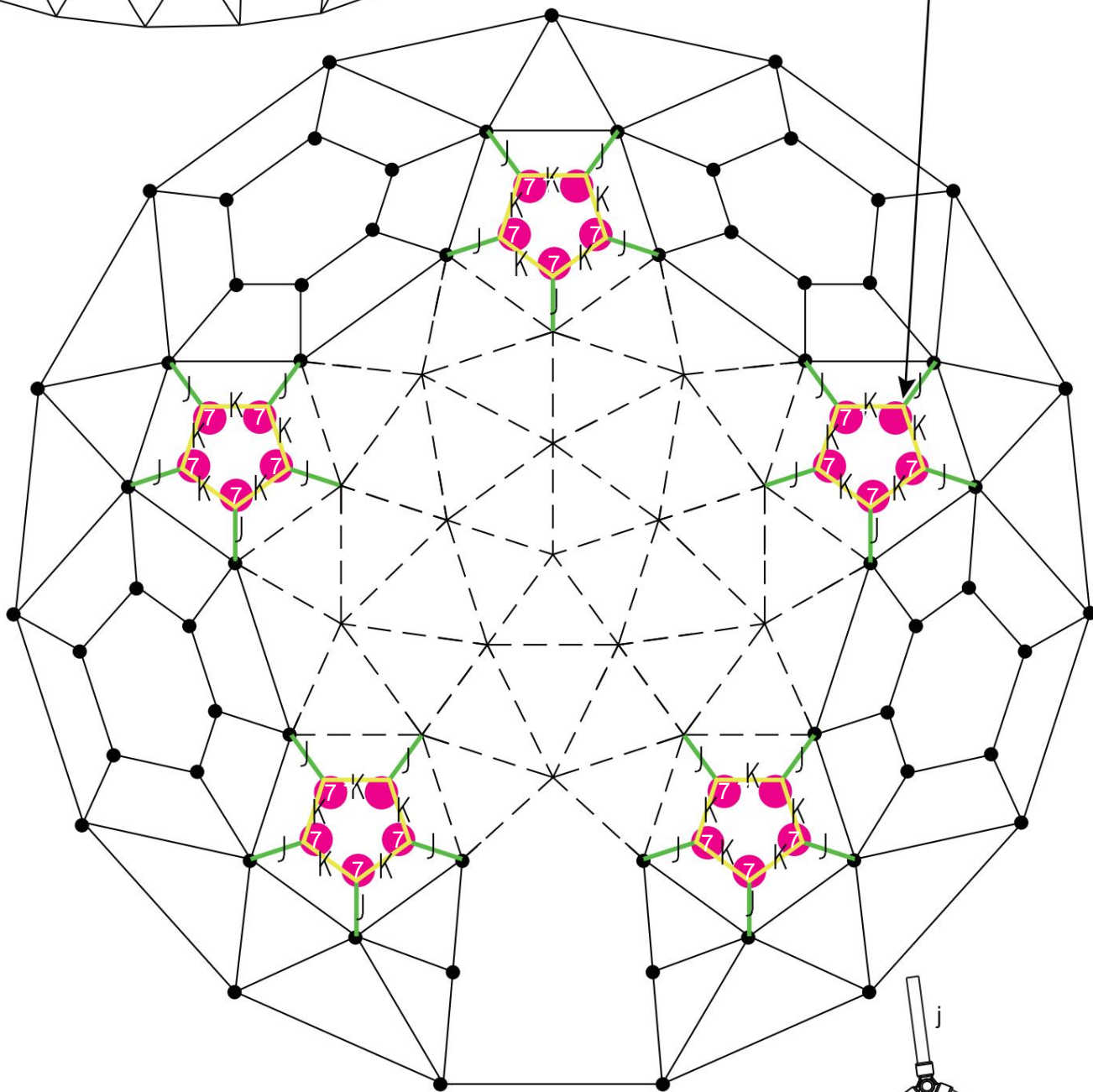
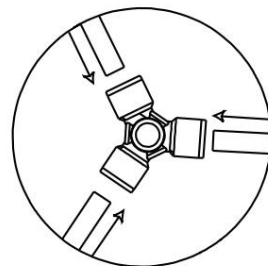
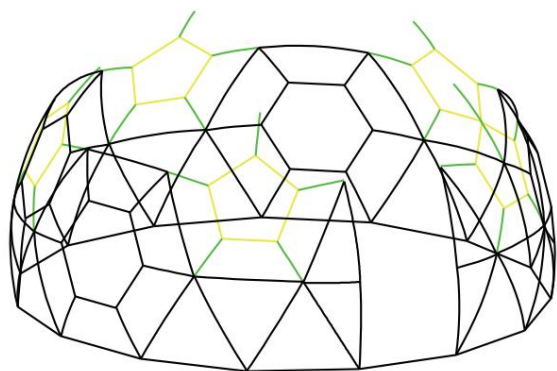

7 x 25

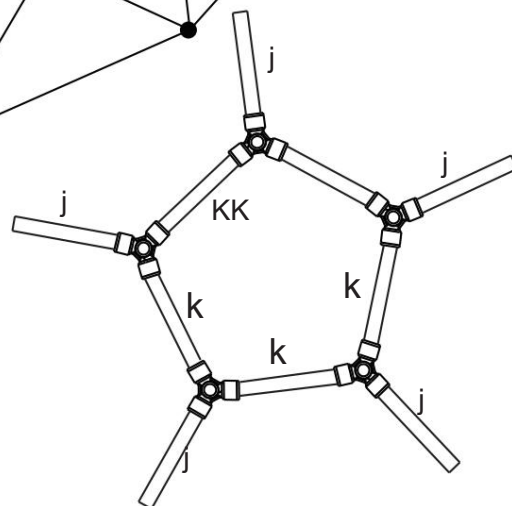

# Paso-09

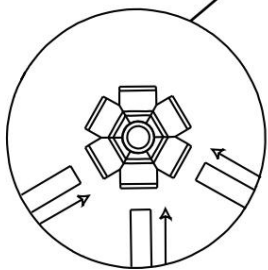
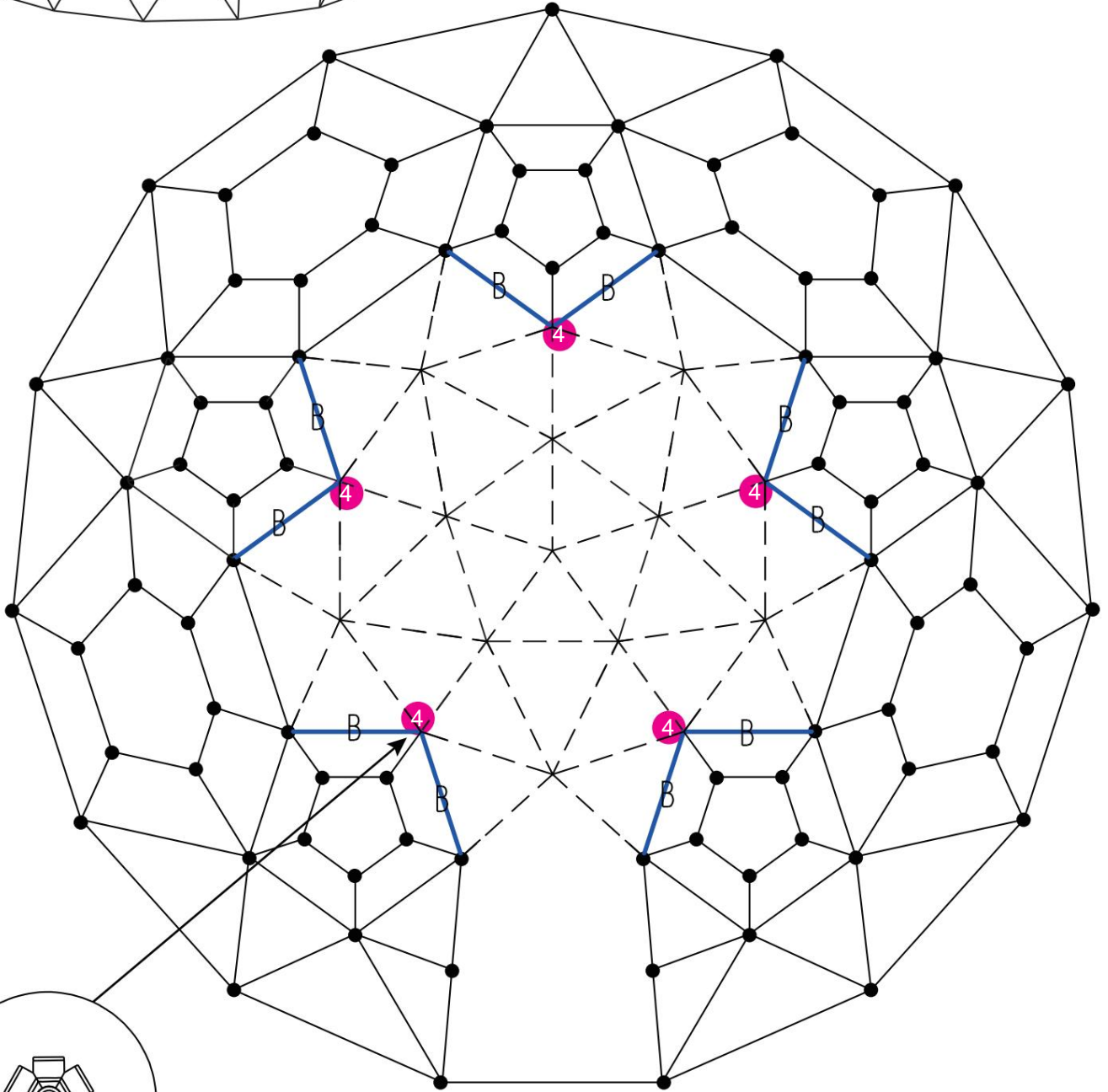
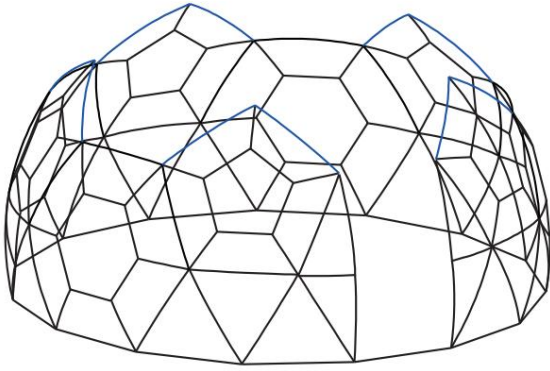

B  10 piezas



4 x5



# Paso-10

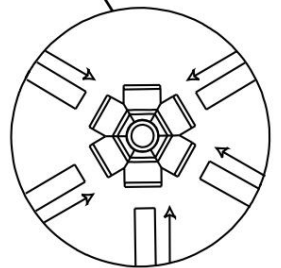
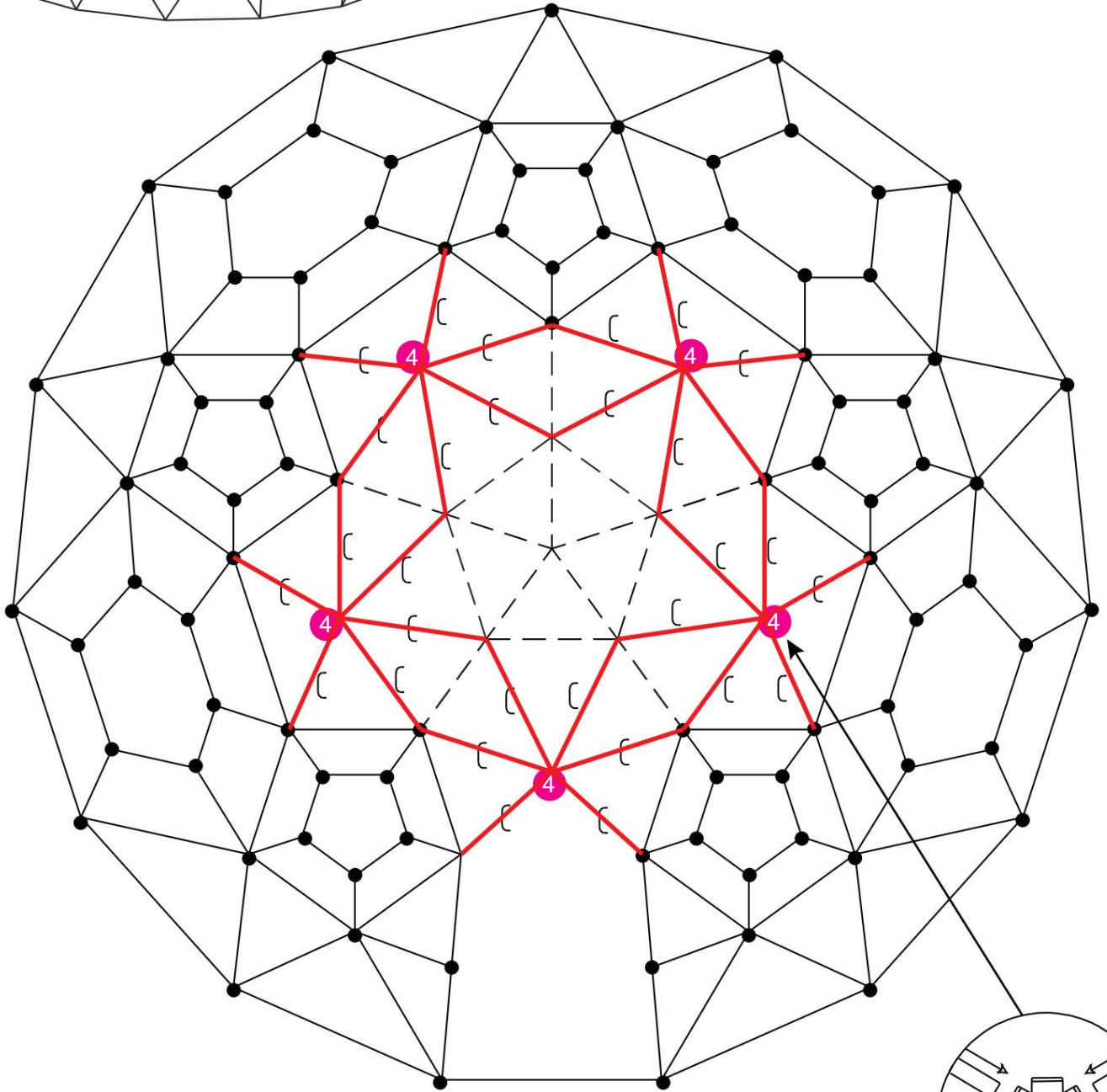
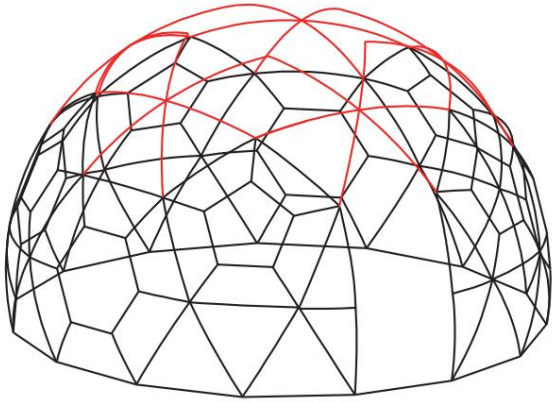

C   
71cm / 30 piezas

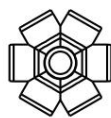

4 x5

# Paso-11

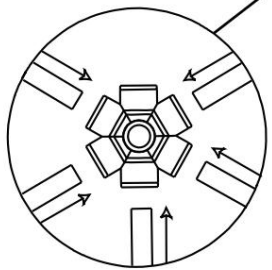
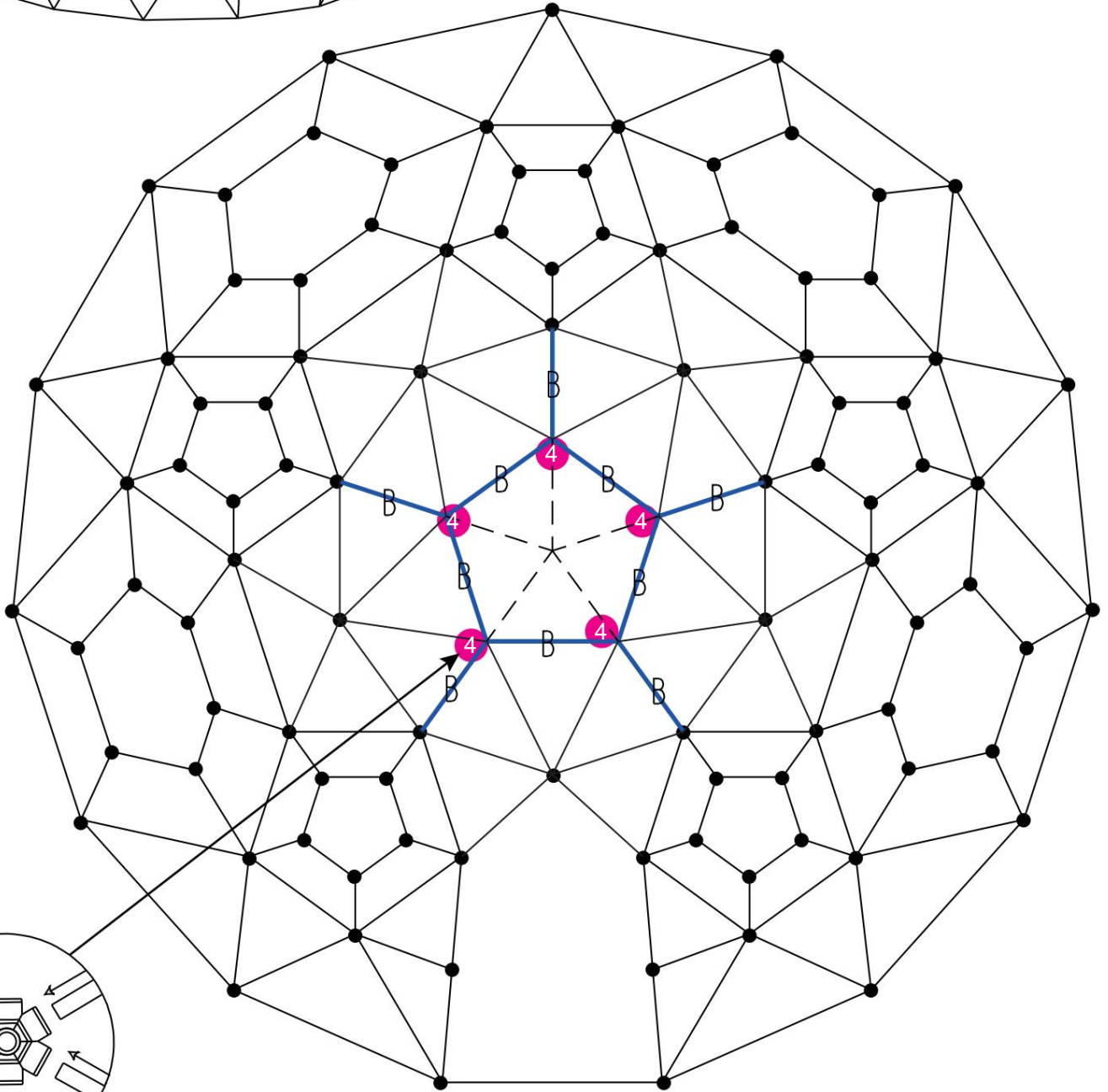
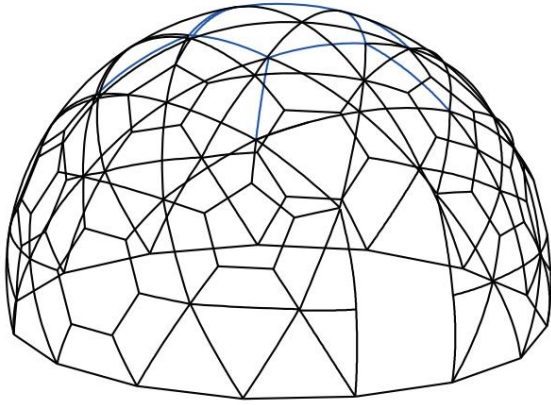

B   
10 piezas

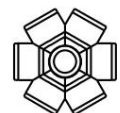

4 x 5

# Paso-12

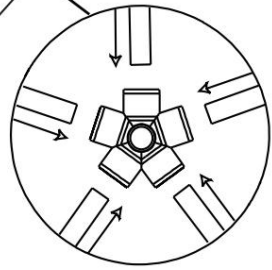
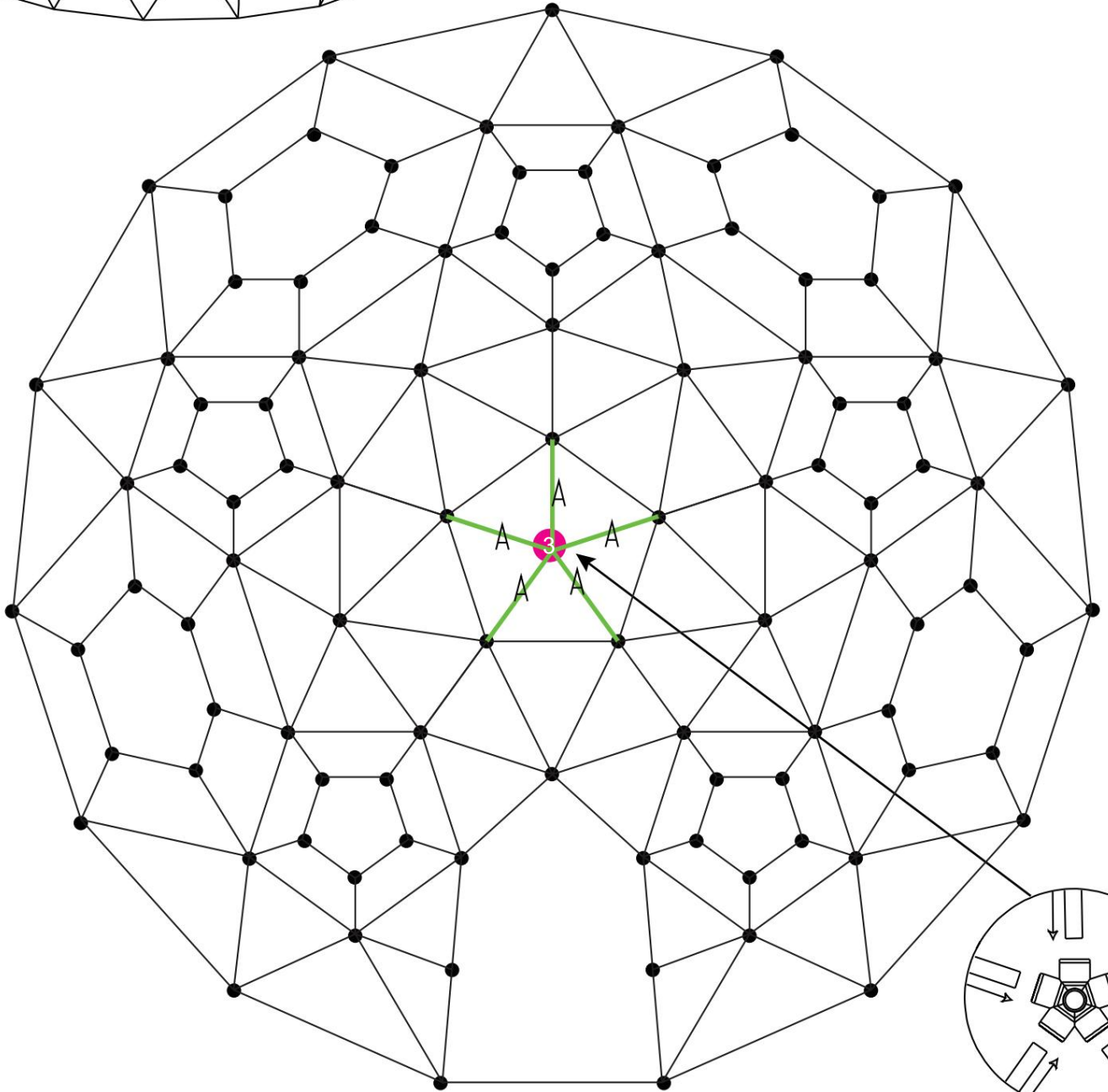
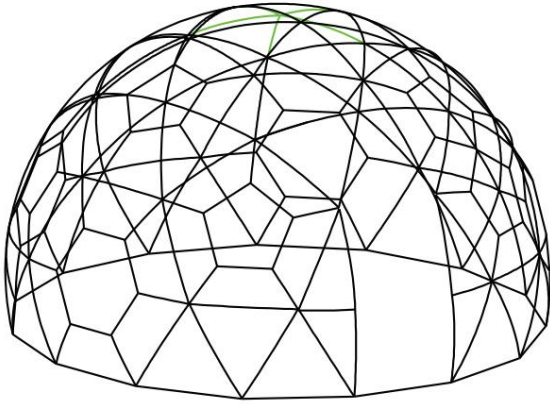

3 x 1

# Paso-13

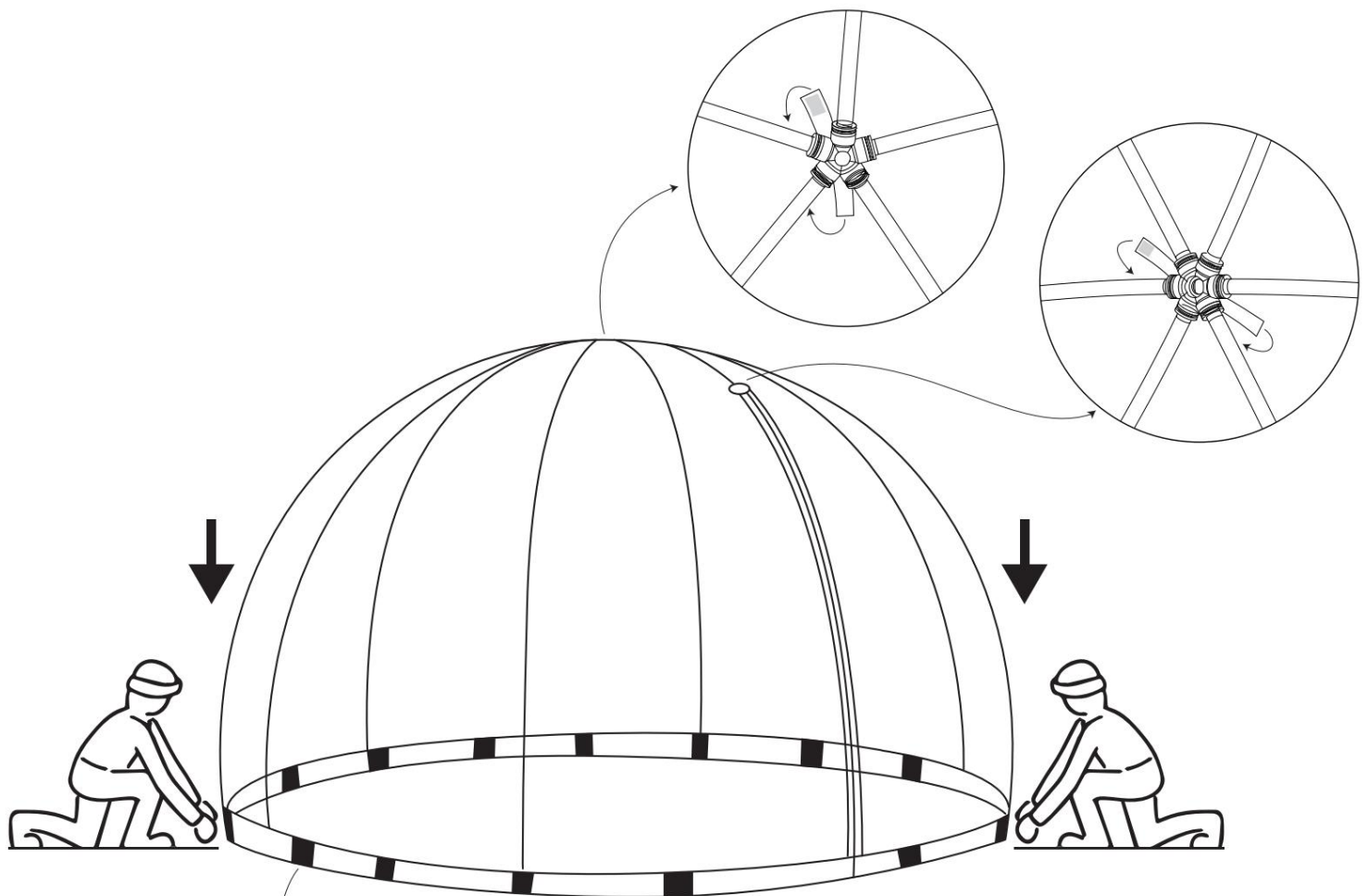

cubierta de pvc o cubierta contra mosquitos

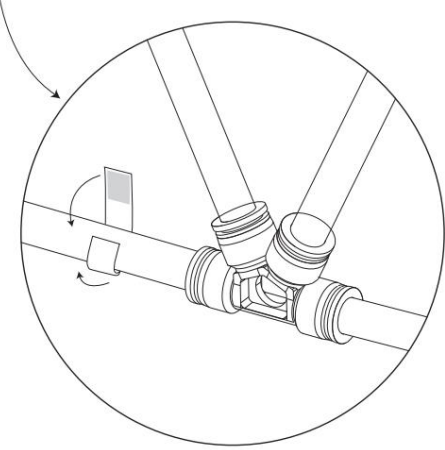

x14

# Paso-14

## Opción 1

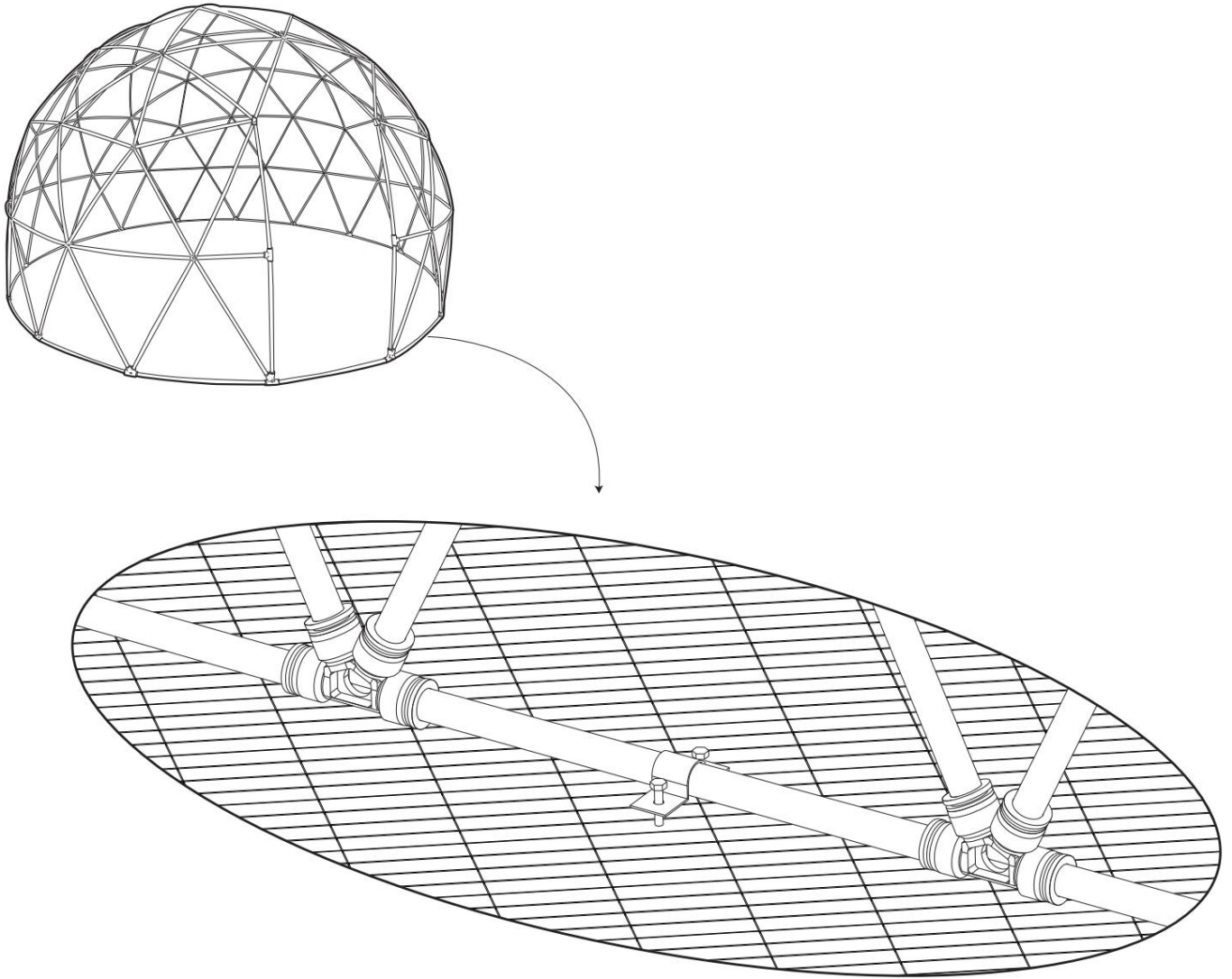

Instalar en el piso de madera/wpc

# Paso-15

opcion 2

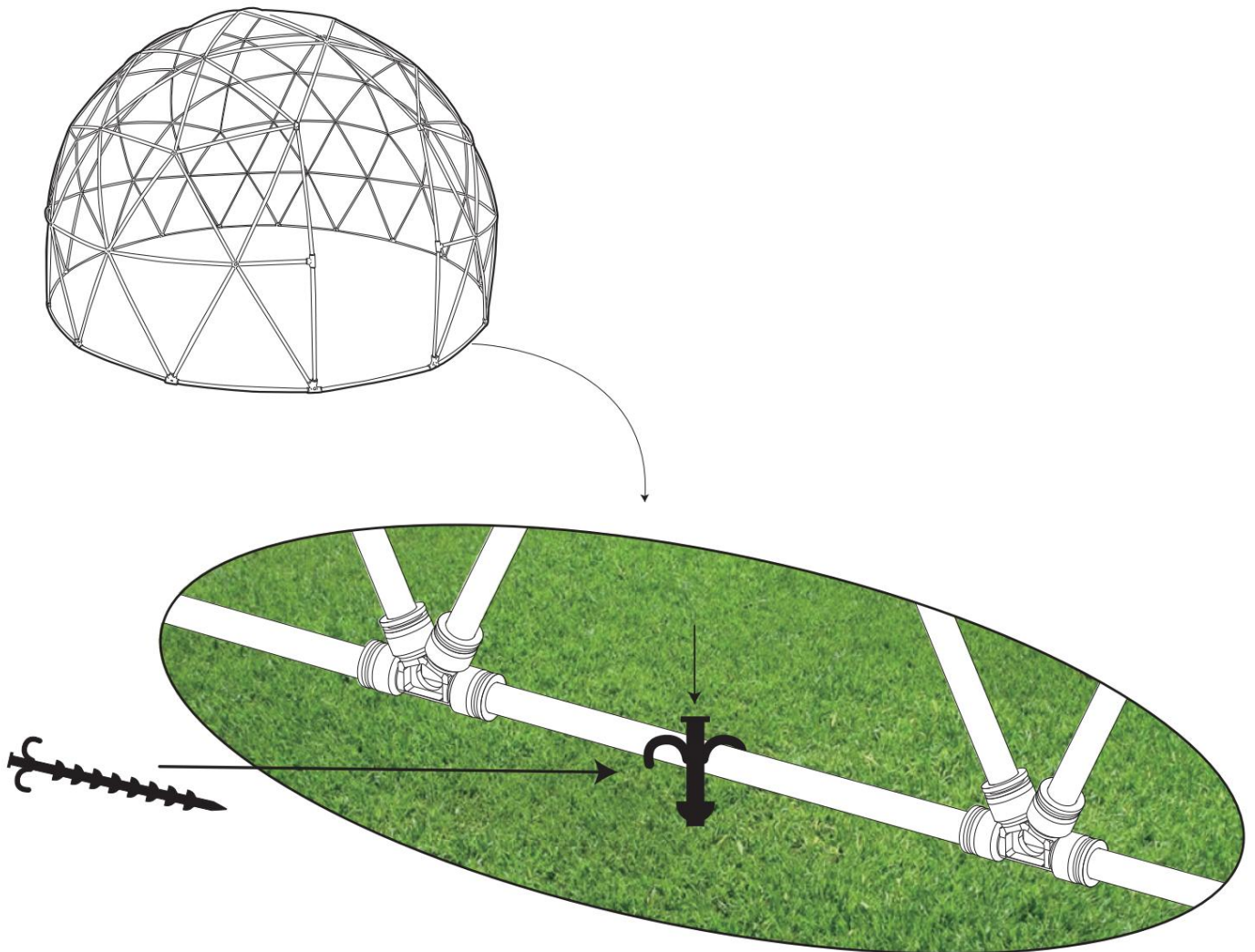

Instalar en el suelo de césped.

# Paso-16

## Opción 3: saco de arena

Precaución: para evitar que el viento rompa

el saco de arena es necesario, 14 piezas

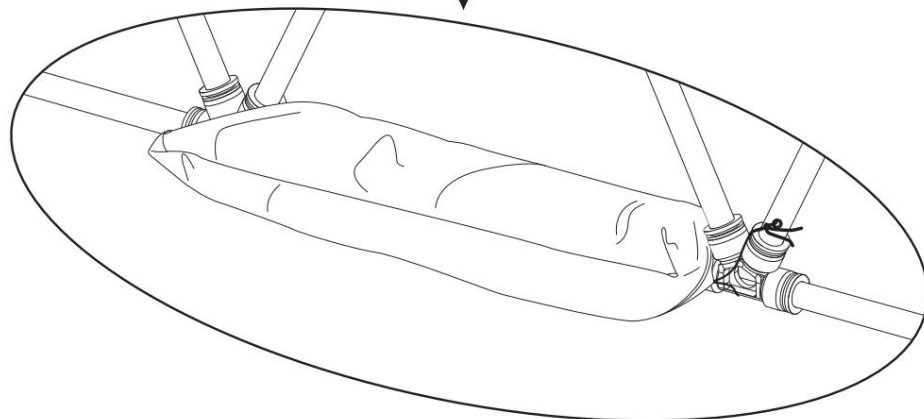
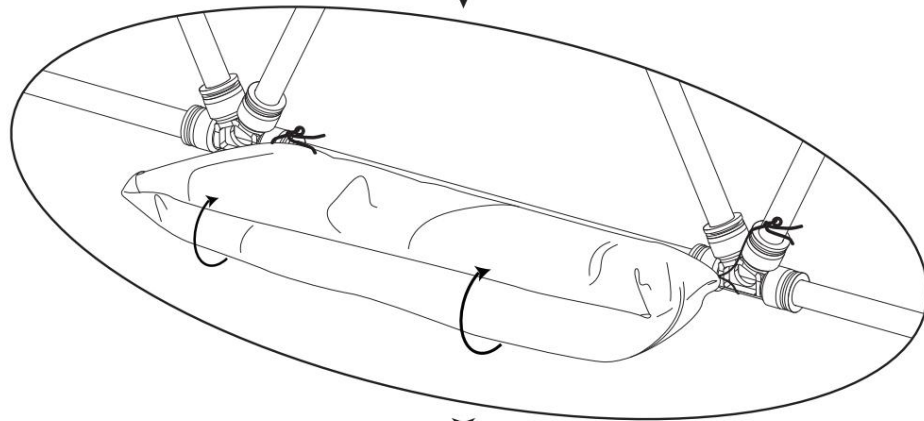
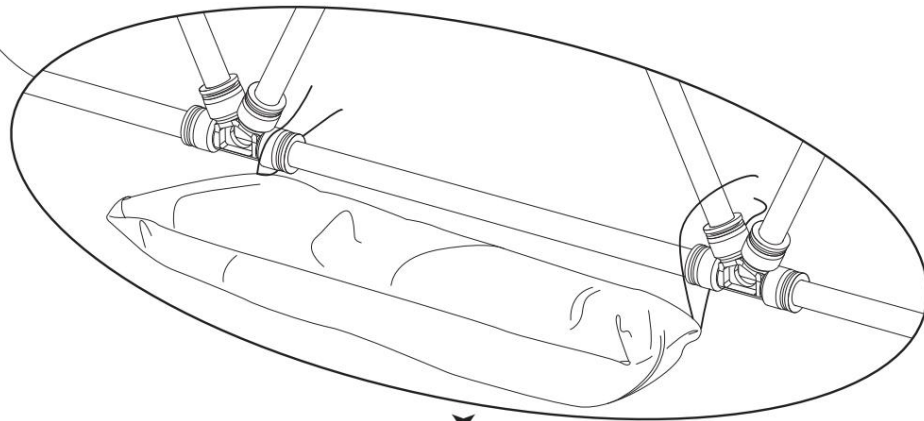
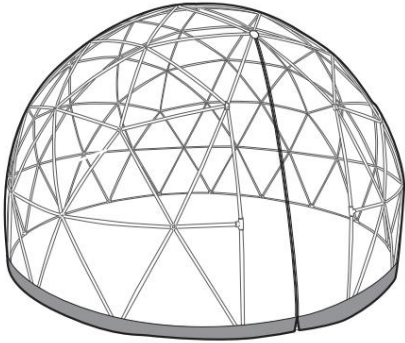

# Paso-17

Consejos: La cubierta de PVC tendrá ligeras arrugas después del primer montaje. Permanecer bajo el sol durante aproximadamente un hora mejorará las arrugas.



ADVERTENCIA

MANTENGA TODAS LAS FUENTES DE LLAMA Y CALOR  
LEJOS DE ESTA TELA DEL DOMO

**Manufacturer:**Shanghaimuxinmuyeyouxiangongsi

**Address:** Shuangchenglu 803nong11hao1602A-1609shi, baoshanqu, shanghai 200000 CN.

**Imported to AUS:** SIHAO PTY LTD. 1 ROKEVA STREETEASTWOOD NSW 2122 Australia

**Imported to USA:** Sanven Technology Ltd. Suite 250, 9166 Anaheim Place, Rancho Cucamonga, CA 91730



E-CrossStu GmbH  
Mainzer Landstr.69, 60329 Frankfurt am Main.



YH CONSULTING LIMITED.  
C/O YH Consulting Limited Office 147, Centurion House,  
London Road, Staines-upon-Thames, Surrey, TW18 4AX



**VEVOR**<sup>®</sup>

**TOUGH TOOLS, HALF PRICE**

Technical Support and E-Warranty Certificate

[www.vevor.com/support](http://www.vevor.com/support)

# **VEVOR<sup>®</sup>**

## **TOUGH TOOLS, HALF PRICE**

Technical Support and E-Warranty Certificate [www.vevor.com/support](http://www.vevor.com/support)

## **GIARDINO ESTERNO CHIARO DOOM MANUALE D'USO**

Continuiamo a impegnarci per fornirvi strumenti a prezzi competitivi. "Risparmia la metà", "Metà prezzo" o qualsiasi altra espressione simile da noi utilizzata rappresenta solo una stima del risparmio che potresti trarre dall'acquistare determinati strumenti con noi rispetto ai principali marchi più importanti e non significa necessariamente coprire tutte le categorie di strumenti offerti da noi. Ti ricordiamo di verificare attentamente quando effettui un ordine con noi se stai effettivamente risparmiando la metà rispetto ai migliori marchi principali.

**VEVOR**<sup>®</sup>  
TOUGH TOOLS, HALF PRICE

GIARDINO ESTERNO CHIARO  
DESTINO

Model: GB-DOME-12, GB-DOME-12T, GB-DOME-9.5 GB-DOME-9.5T

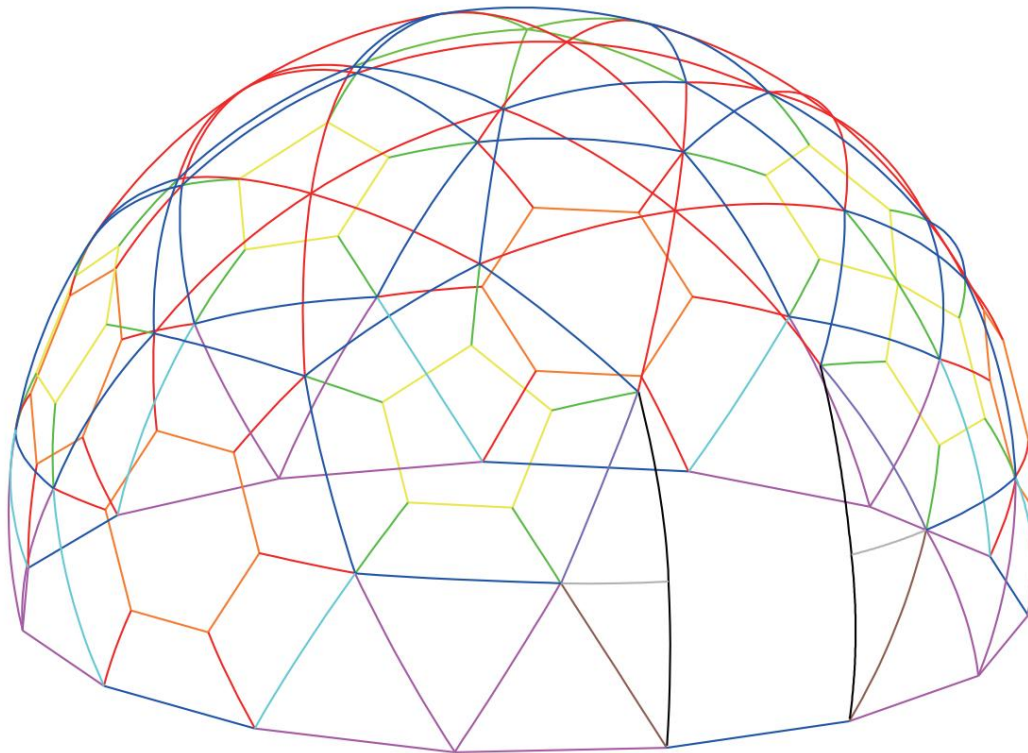

HO BISOGNO DI AIUTO? CONTATTACI!

Hai domande sul prodotto? Hai bisogno di supporto tecnico? Non esitate a contattarci: Supporto tecnico e certificato di garanzia elettronica [www.vevor.com/support](http://www.vevor.com/support)

Queste sono le istruzioni originali, leggere attentamente tutte le istruzioni del manuale prima dell'uso. VEVOR si riserva una chiara interpretazione del nostro manuale d'uso. L'aspetto del prodotto sarà soggetto al prodotto ricevuto. Ti preghiamo di perdonarci se non ti informeremo più se sono presenti aggiornamenti tecnologici o software sul nostro prodotto.

# SPECIFICHE

Modello	GB-DOME-12
Taglia del prodotto	12 piedi
Colore	Trasparente
Capacità di carico	110 libbre

Modello	GB-DOME-12T
Taglia del prodotto	12 piedi
Colore	Trasparente
Capacità di carico	110 libbre

Modello	GB-DOME-9.5
Taglia del prodotto	9,5 piedi
Colore	Trasparente
Capacità di carico	110 libbre







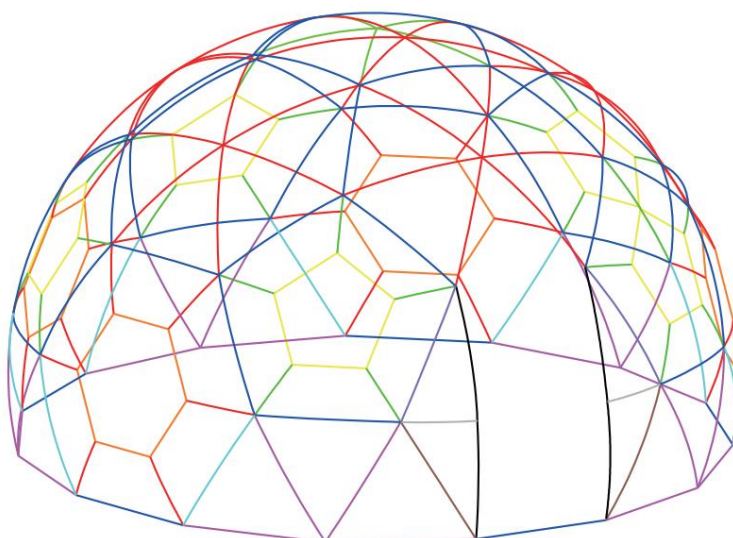

Modello	GB-DOME-9.5T
Taglia del prodotto	9,5 piedi
Colore	Trasparente
Capacità di carico	110 libbre

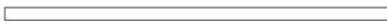
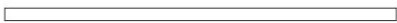
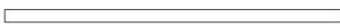
# Accessori

Modello	Copertura in PVC trasparente	Copertura antizanzare
GB-DOME-12	✓	✗
GB-DOME-12T	✓	✓
GB-DOME-9.5	✓	✗
GB-DOME-9.5T	✓	✓

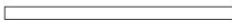

## Tubi:

- UN  5 pezzi
- B  42 pezzi
- C  50 pezzi
- D  4 pezzi
- E  8 pezzi
- G  2 pezzi
- H  2 pezzi
-  2 pezzi
- J  25 pezzi
- K  25 pezzi
- I  24 pezzi
- M  24 pezzi

## Copertina:

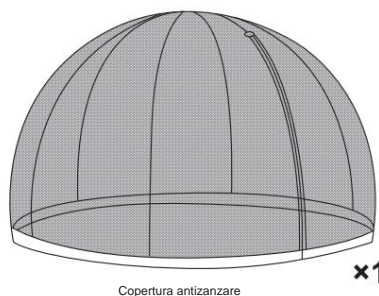
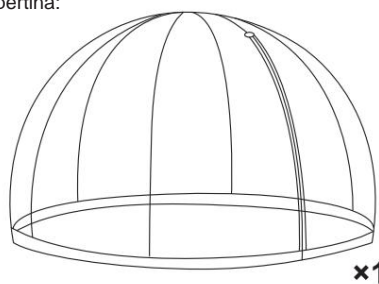

## Valutazioni standard:

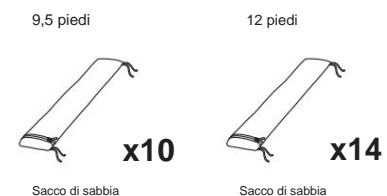

## connettori:

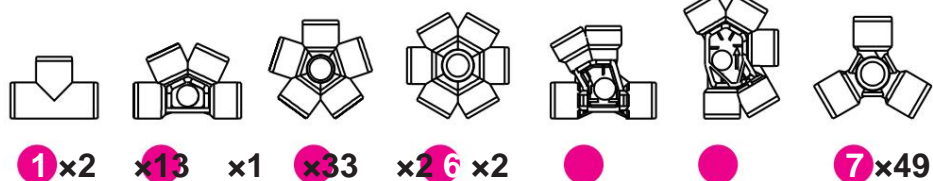

Passaggio-01

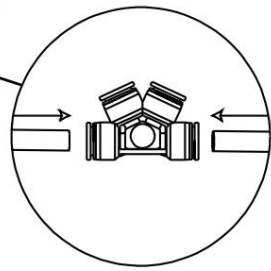
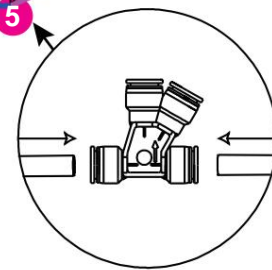
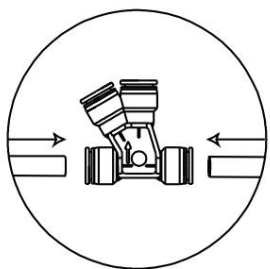
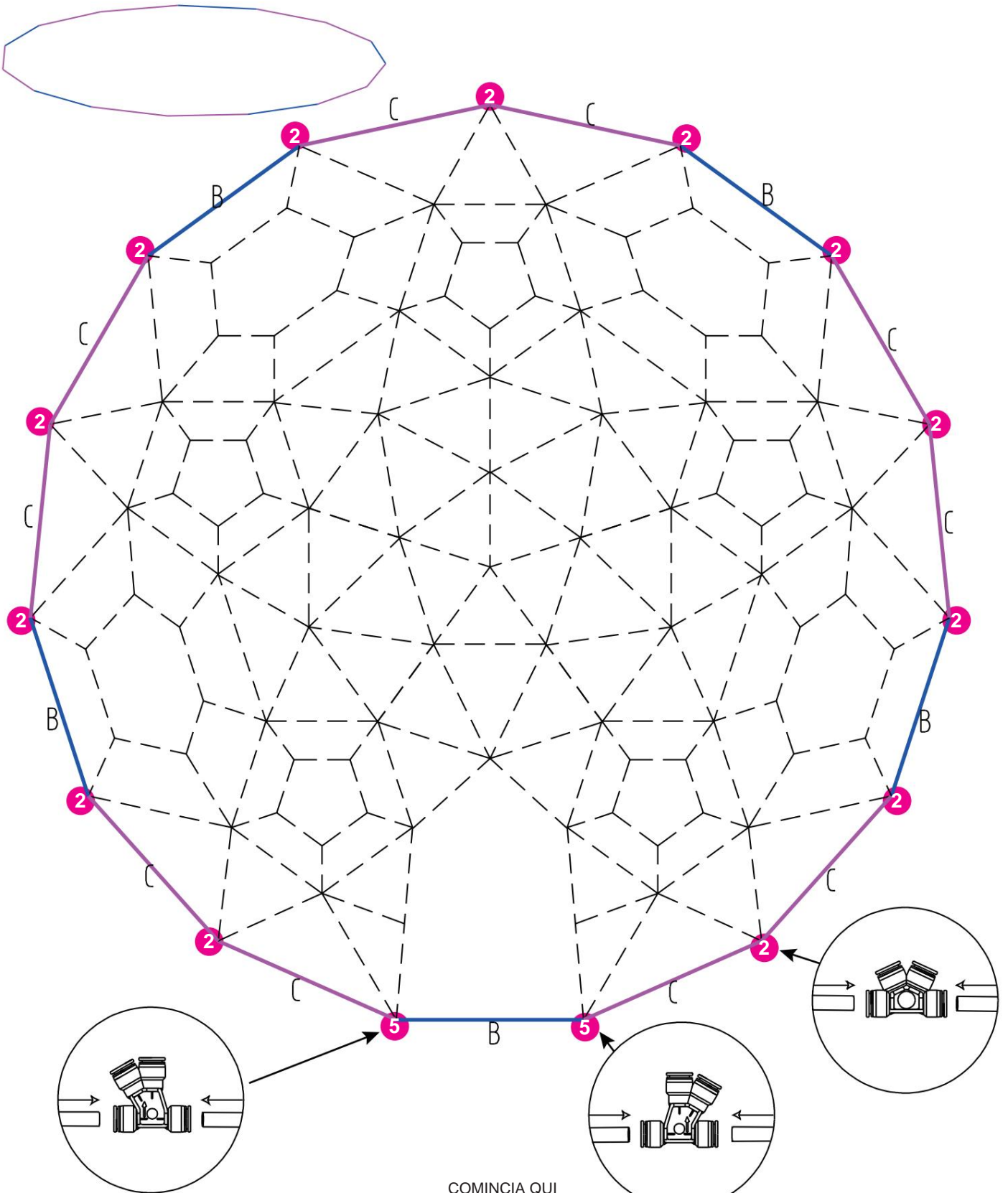

COMINCIA QUI

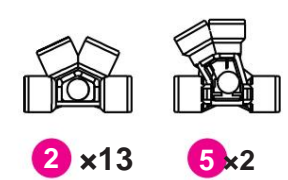
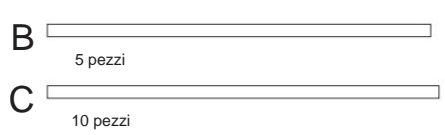

# Passaggio-02

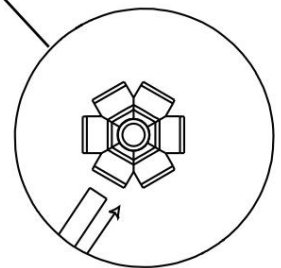
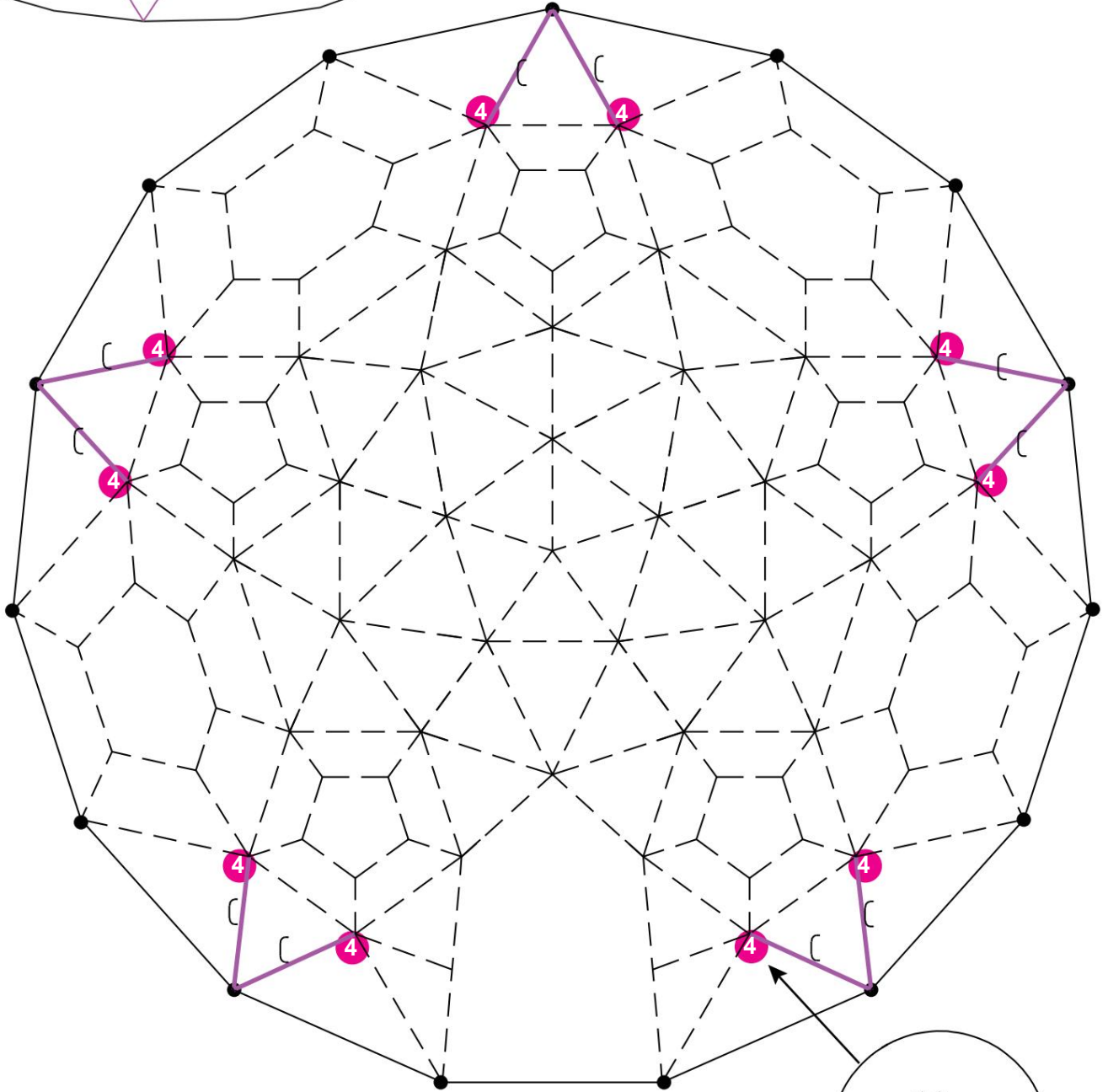
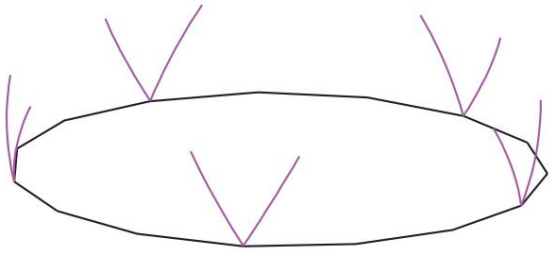

C  10 pezzi

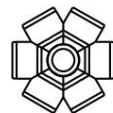

4 x10

# Passaggio-03

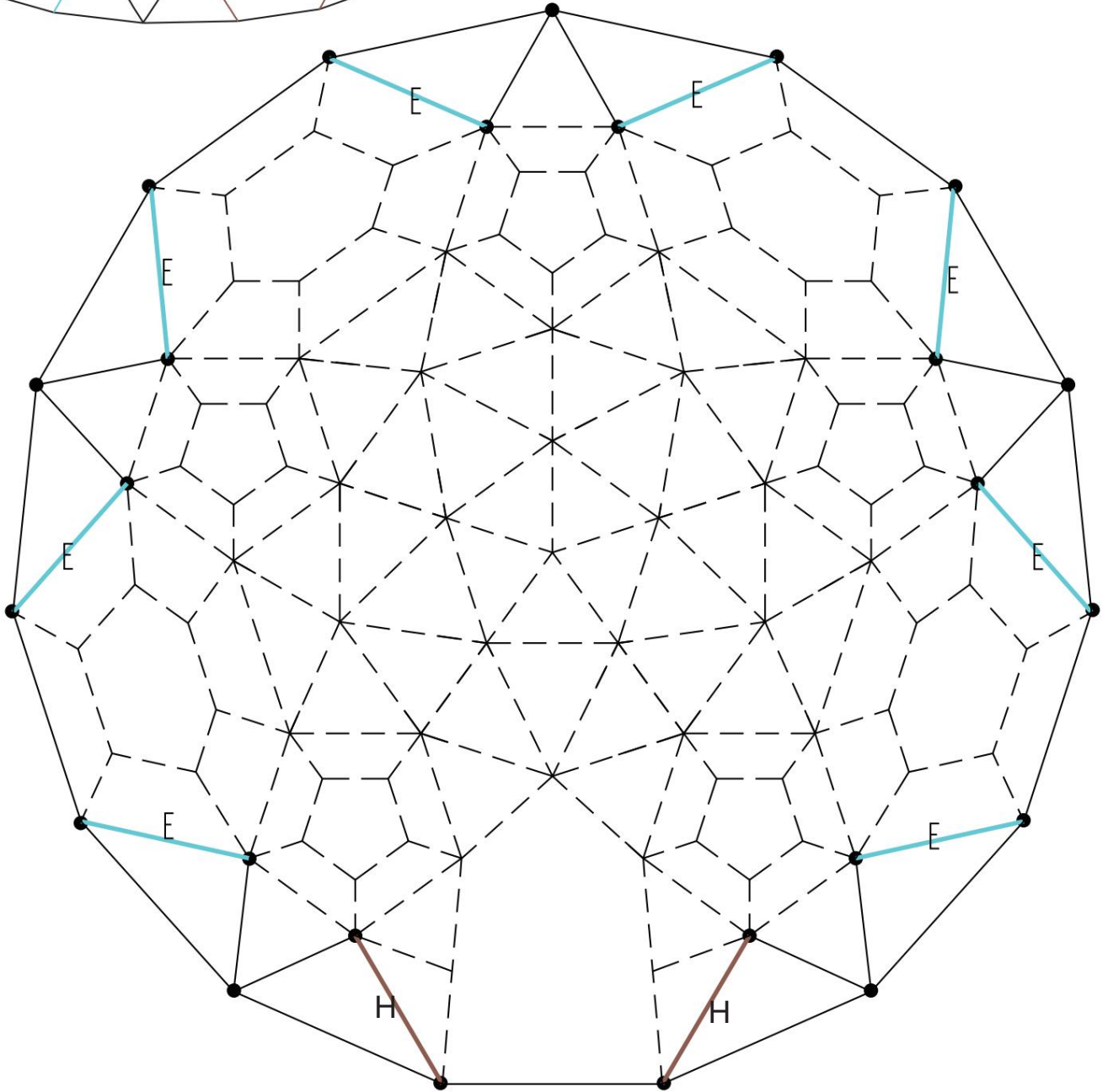
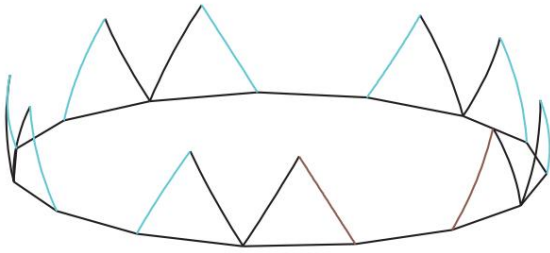

E   
8 pezzi

H   
2 pezzi



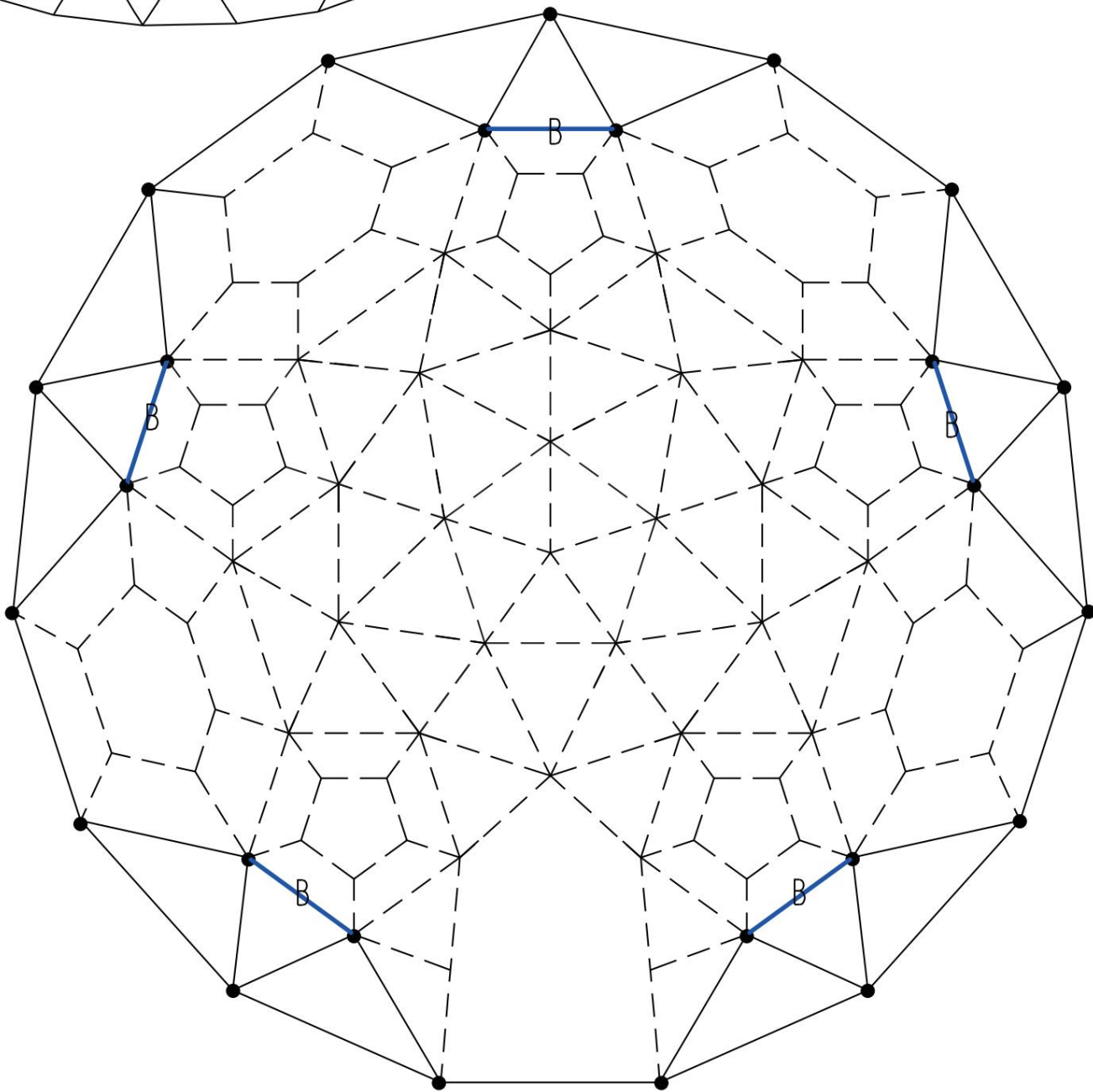
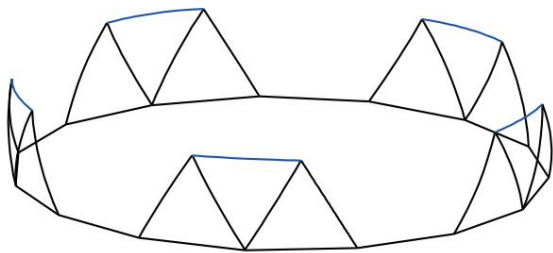

Passaggio-04

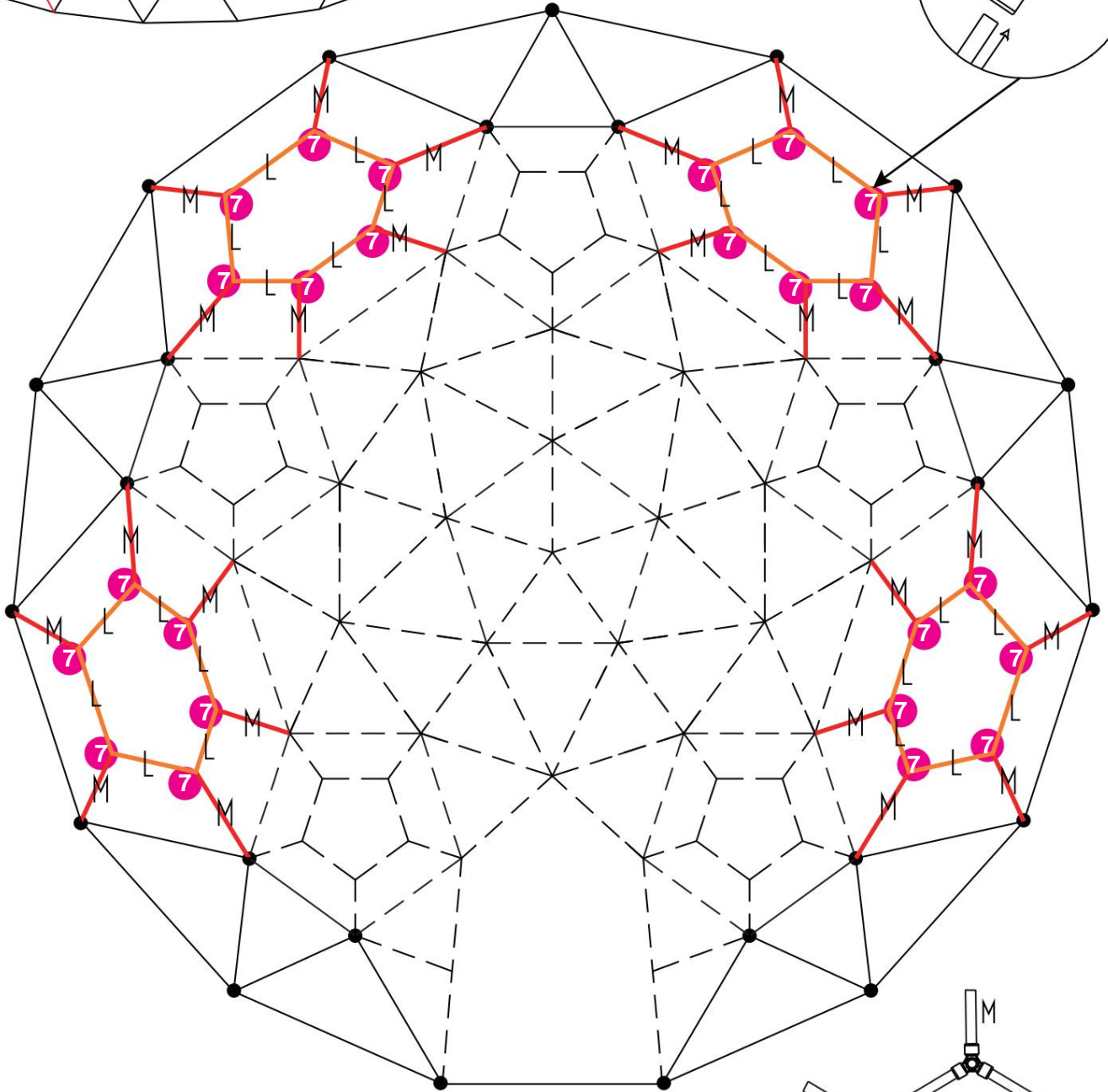
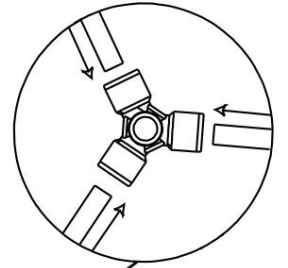
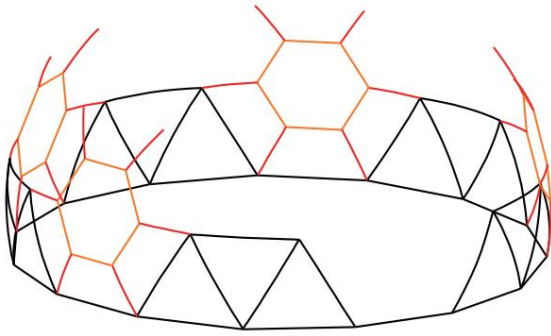

B   
5 pezzi

# Passaggio-05



- I  24 pezzi
- M  24 pezzi



7 x24

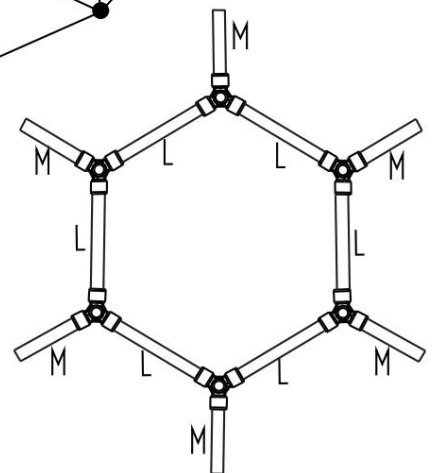

# Passaggio-06

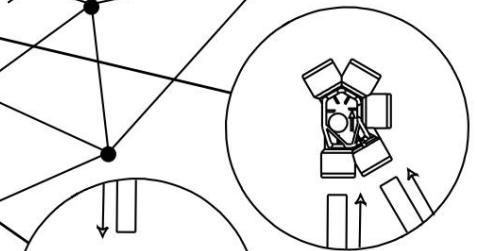
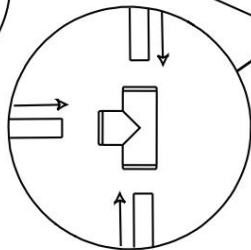
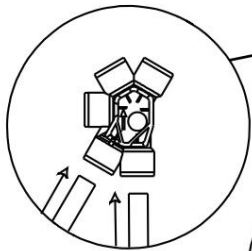
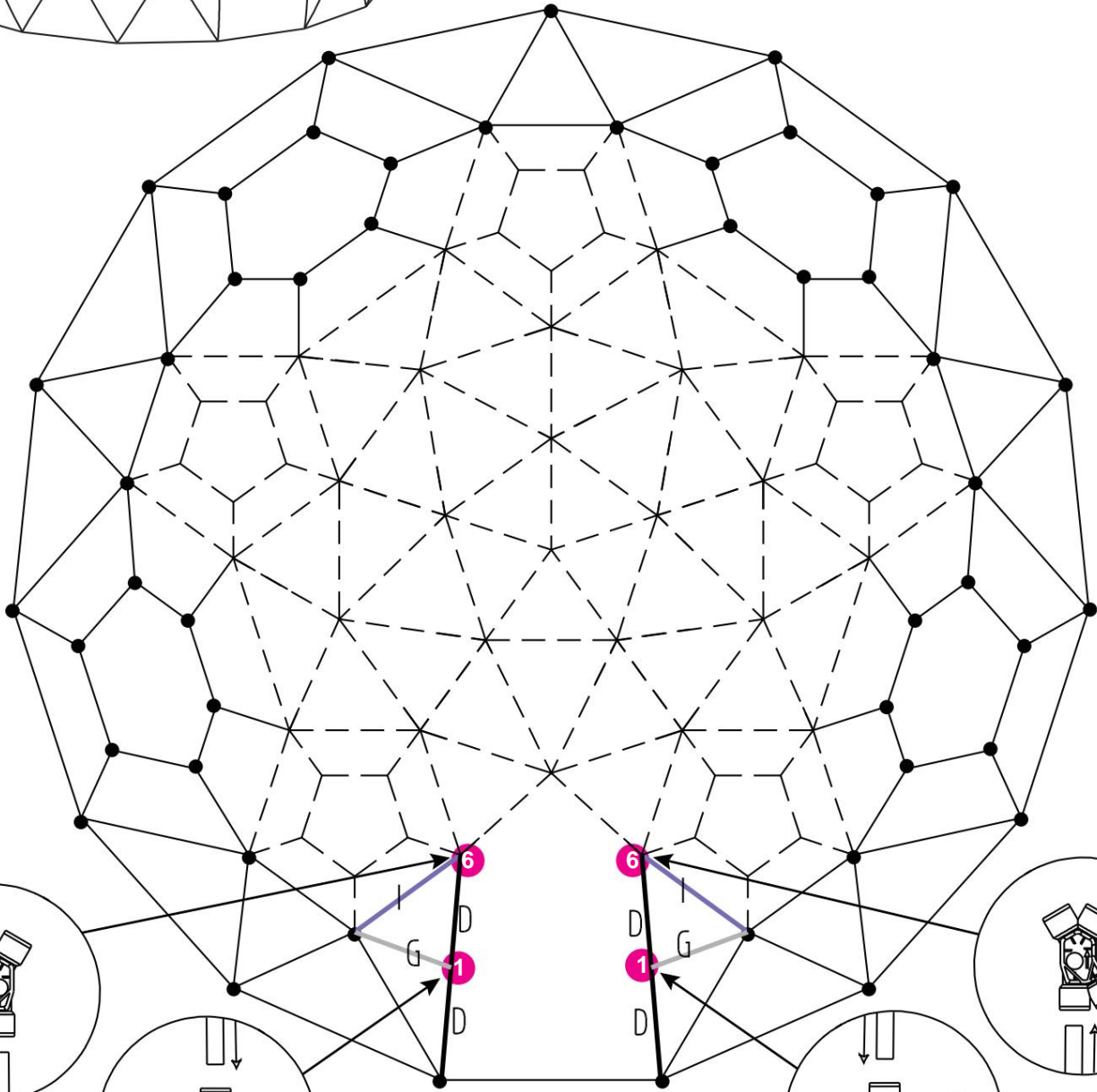
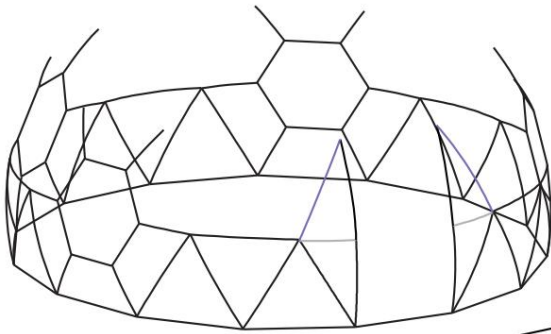

D   
4 pezzi

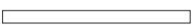
G   
2 pezzi

  
2 pezzi

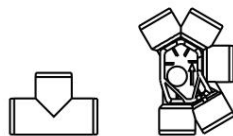

**1** x26

**2**

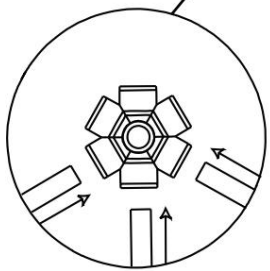
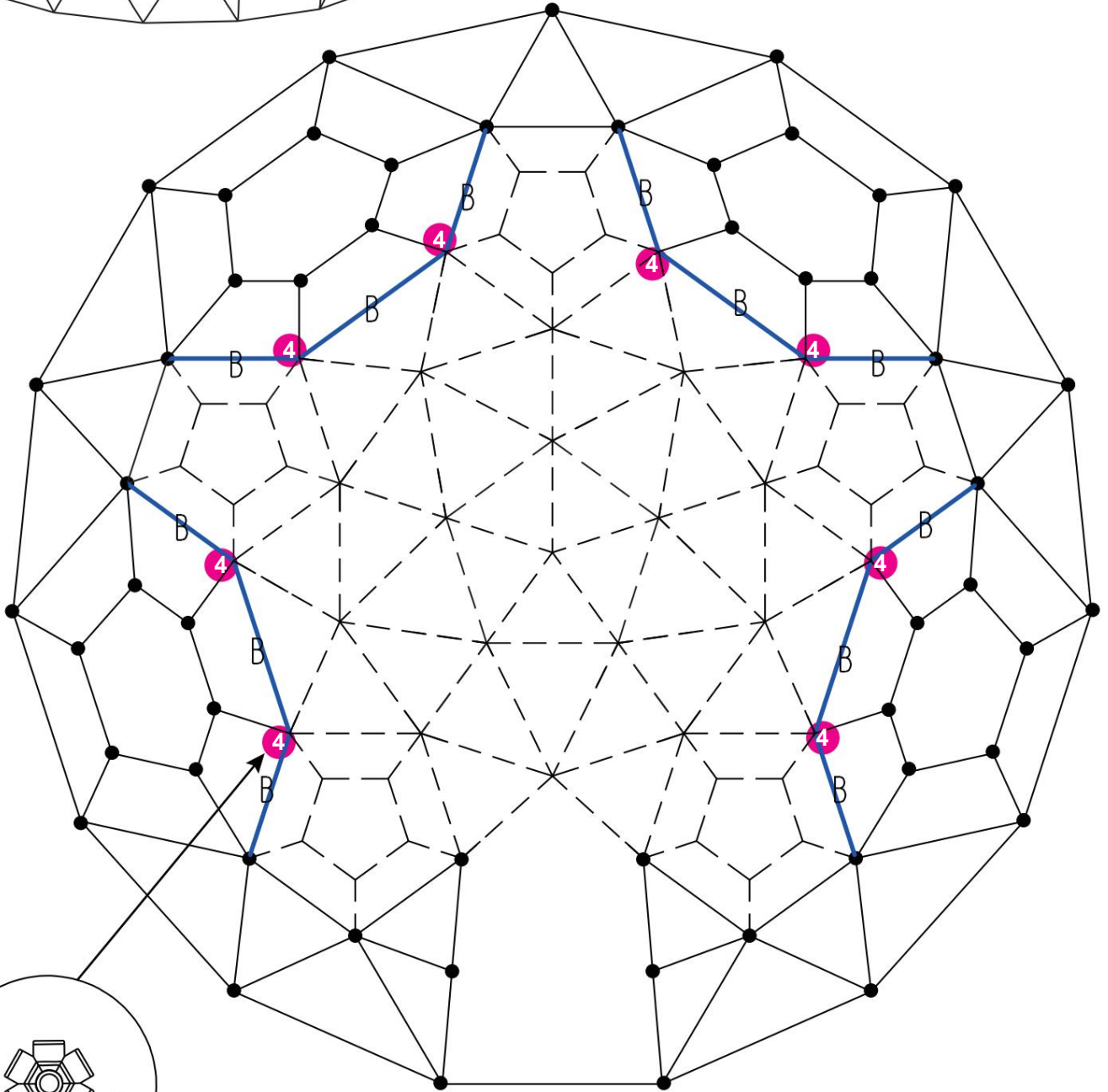
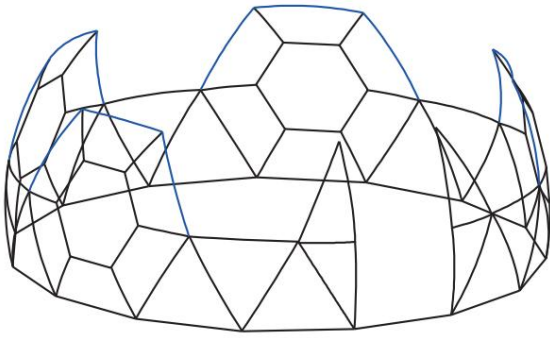



B  12 pezzi

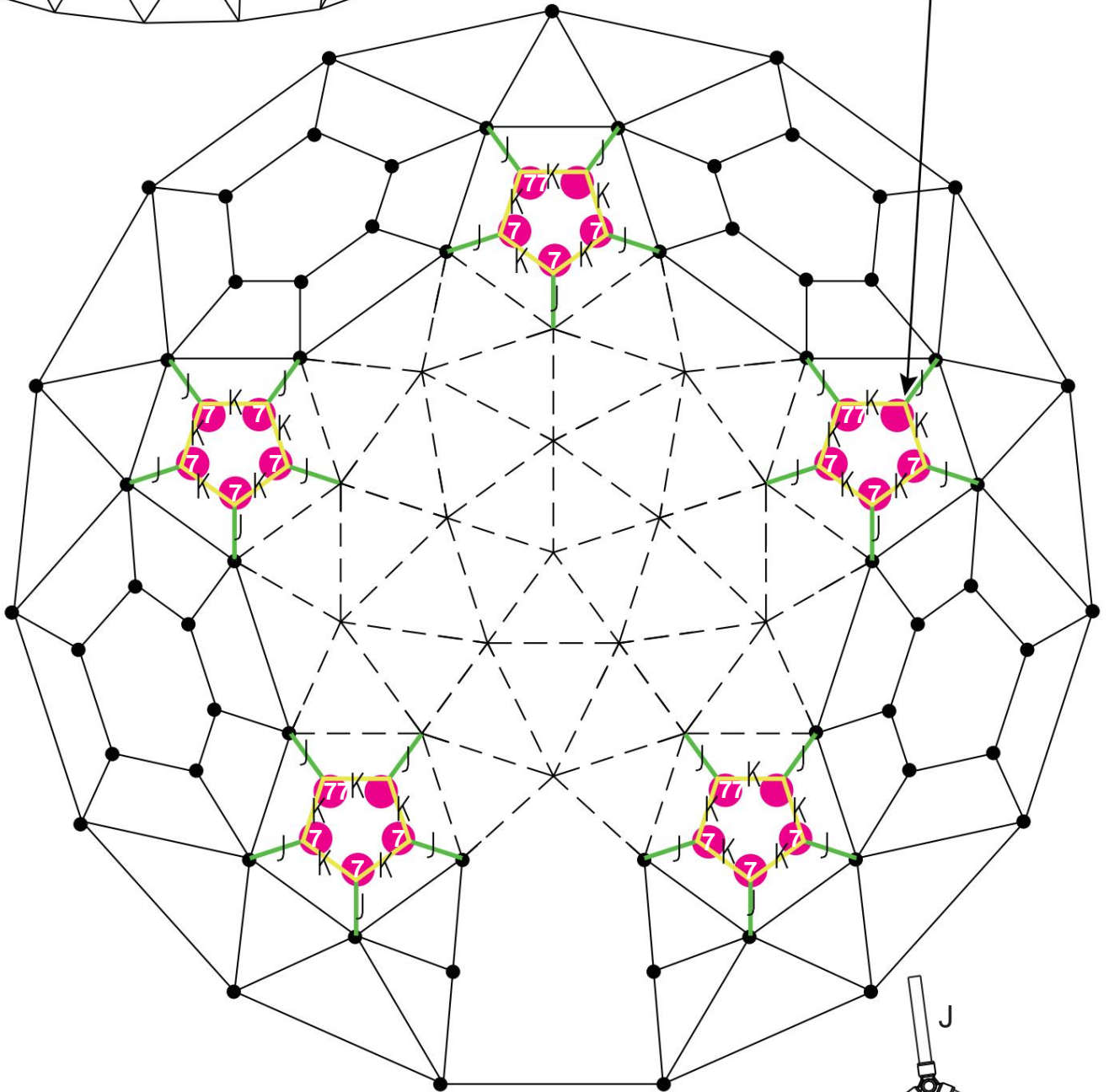
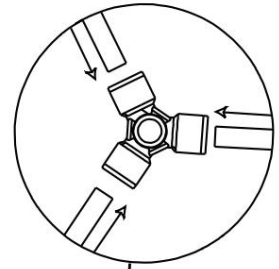
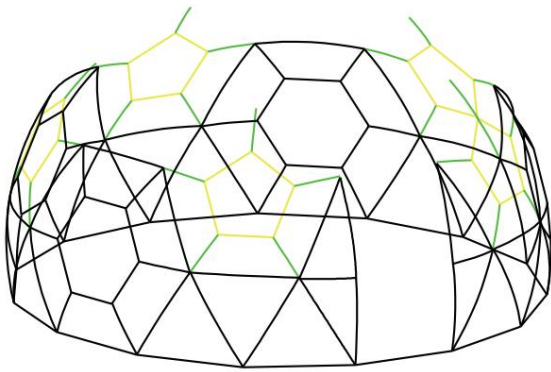

4 x 8

# Passaggio-08

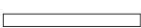

J  25 pezzi  
K  25 pezzi

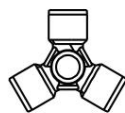

 x25

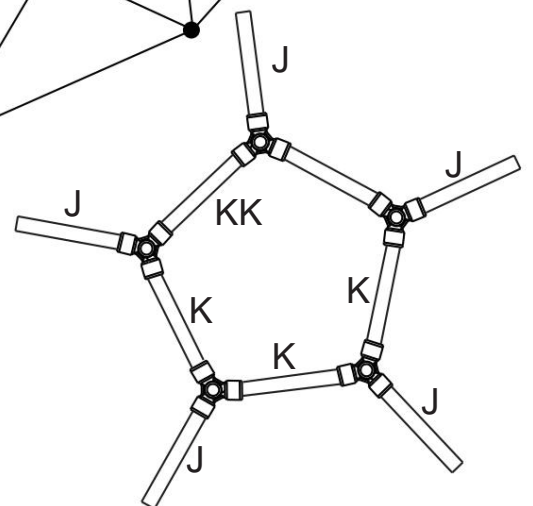

# Passaggio-09

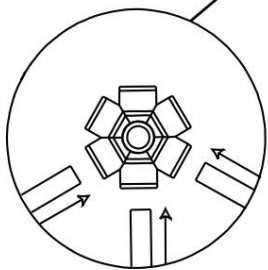
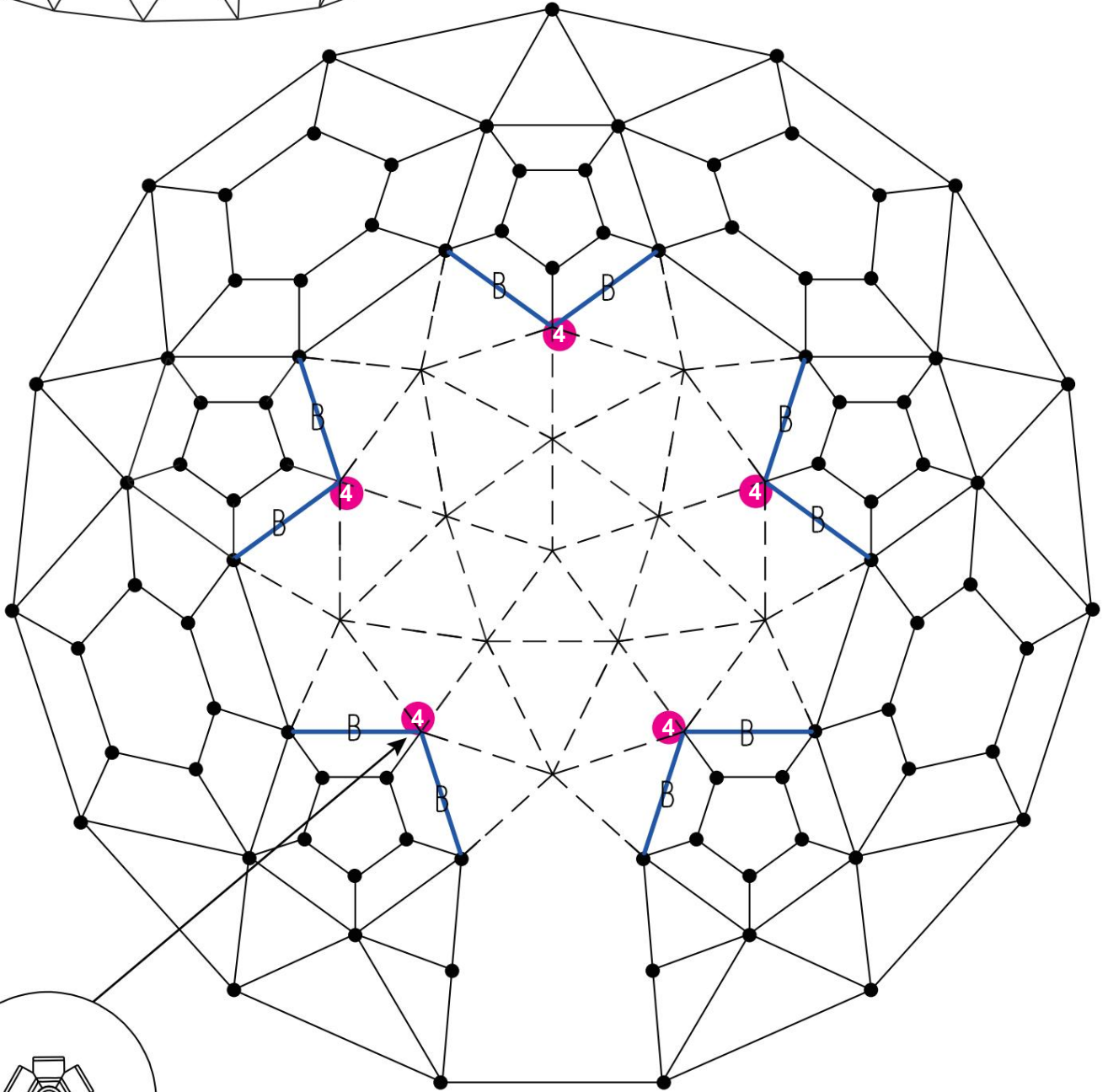
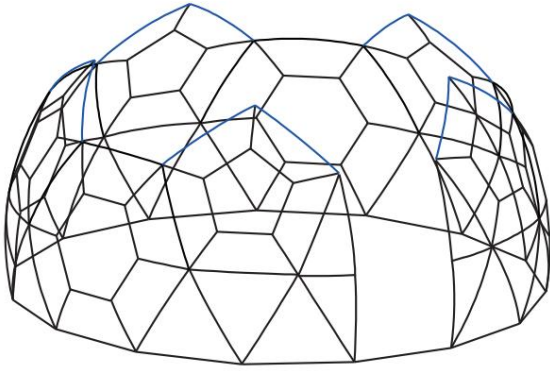

B   
10 pezzi

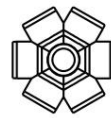

4 x5



# Passaggio 10

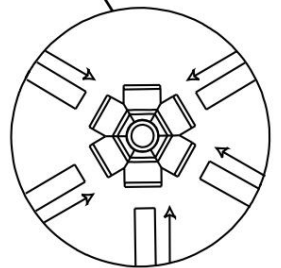
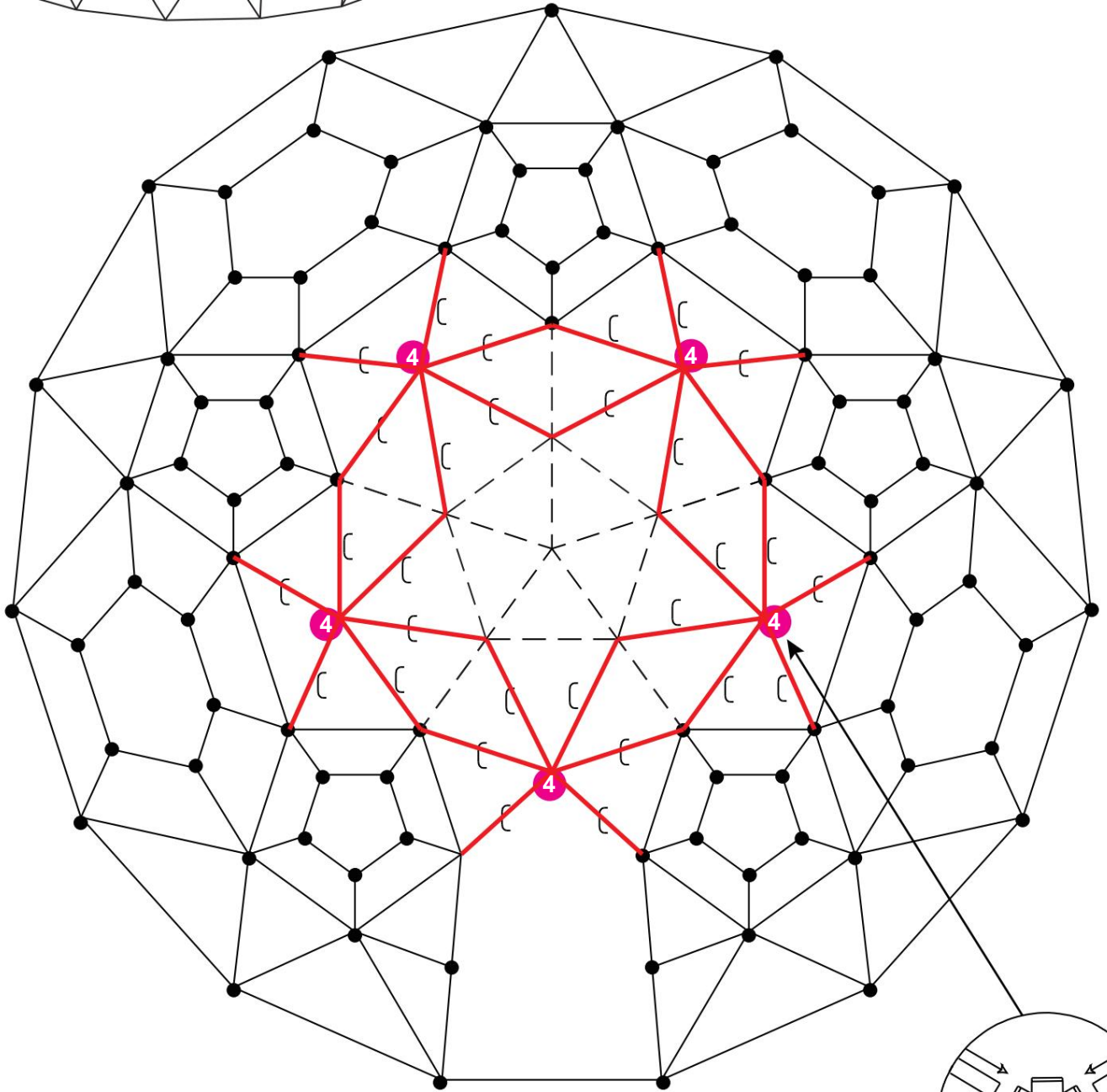
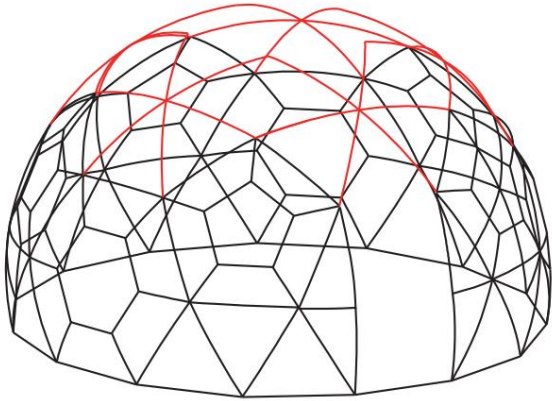

C   
71 cm/ 30 pezzi

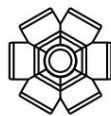

4 x5

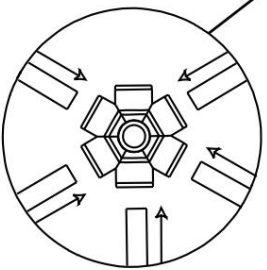
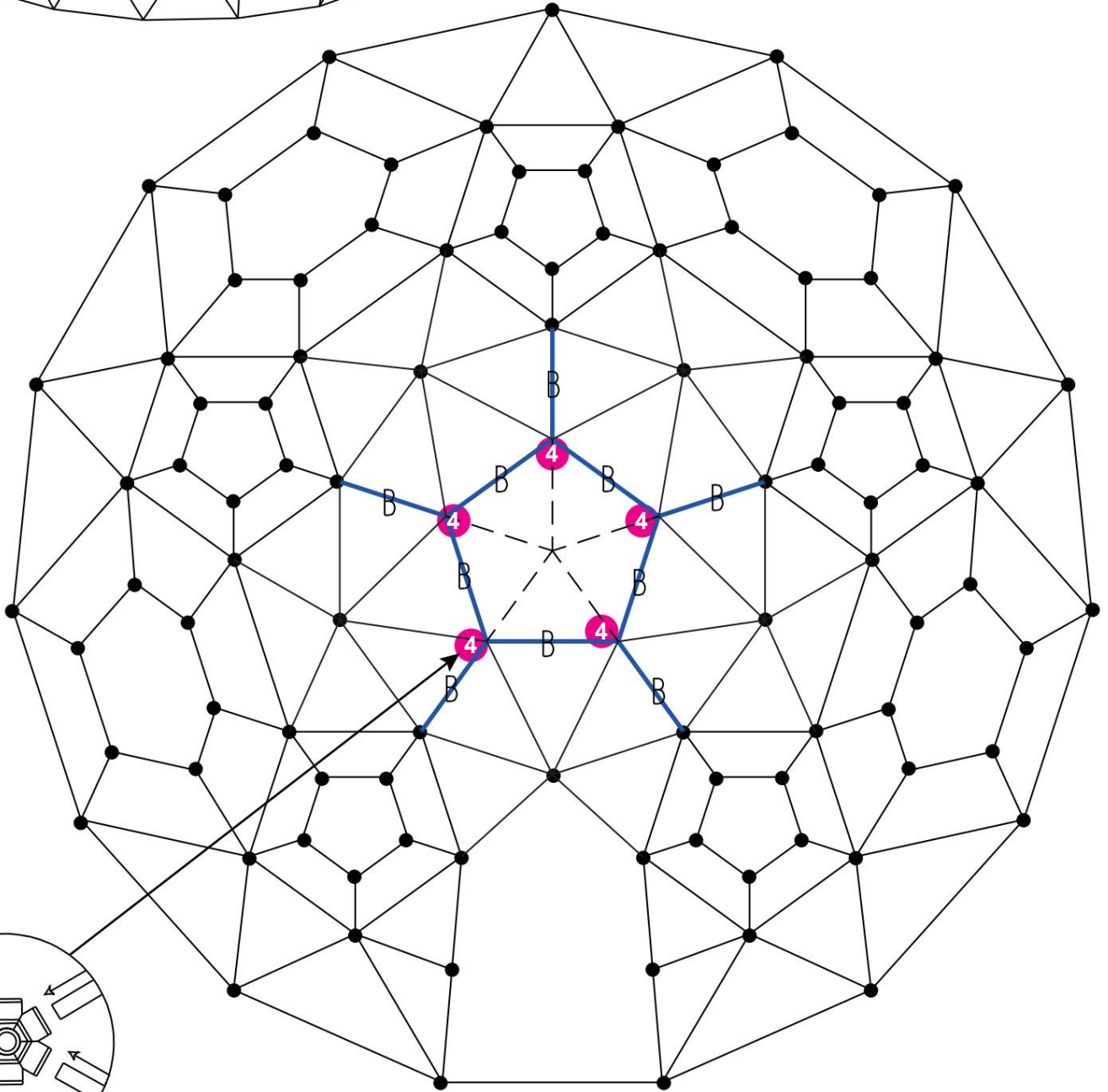
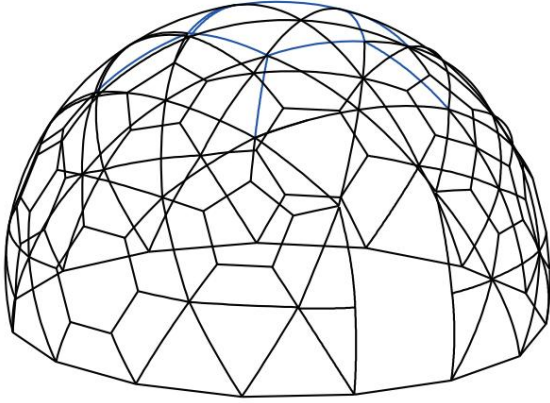

B   
10 pezzi

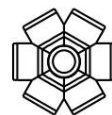

4 x 5

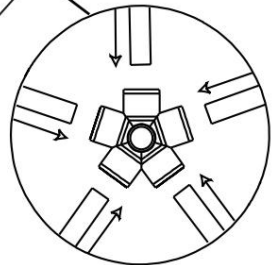
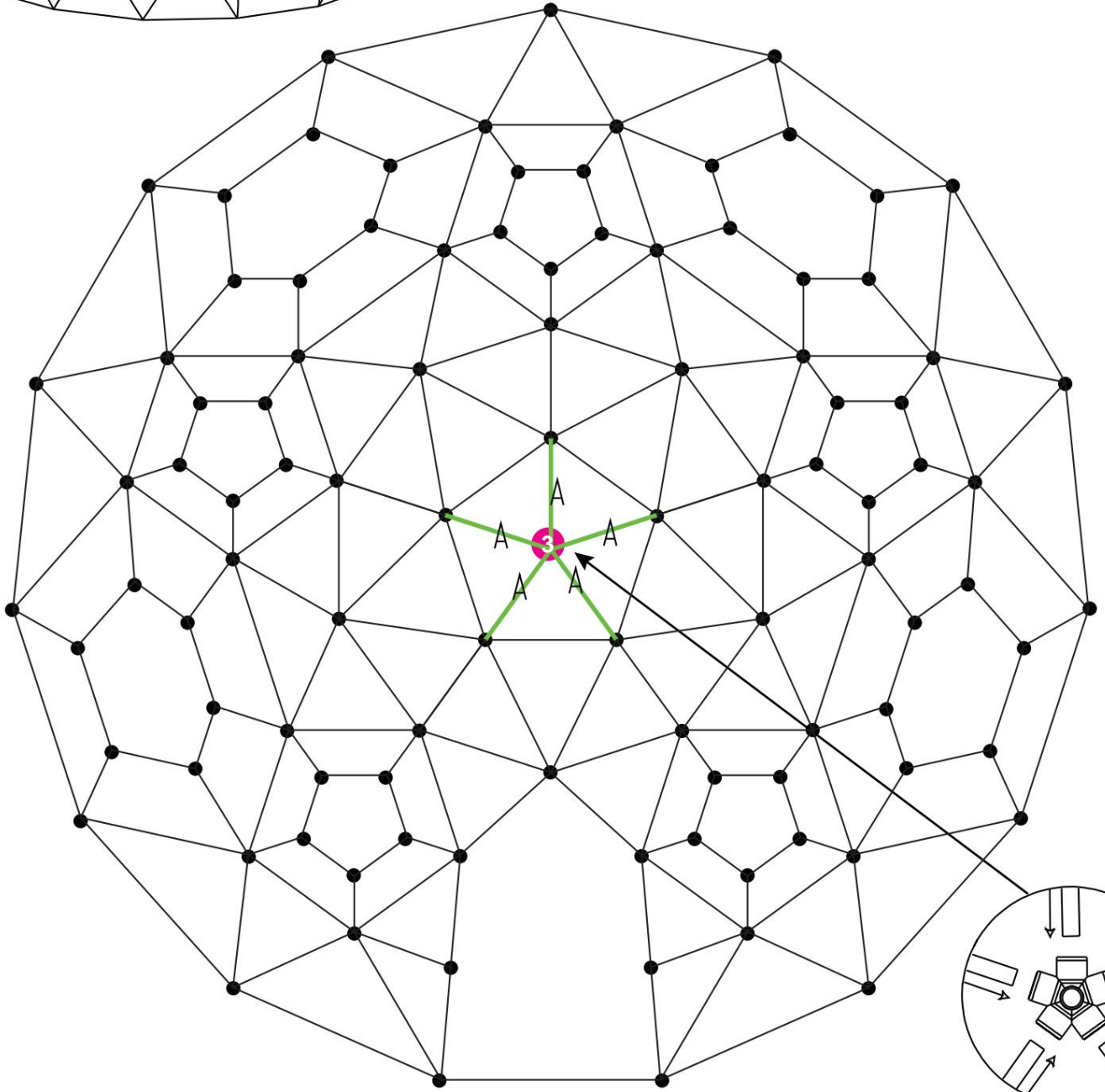
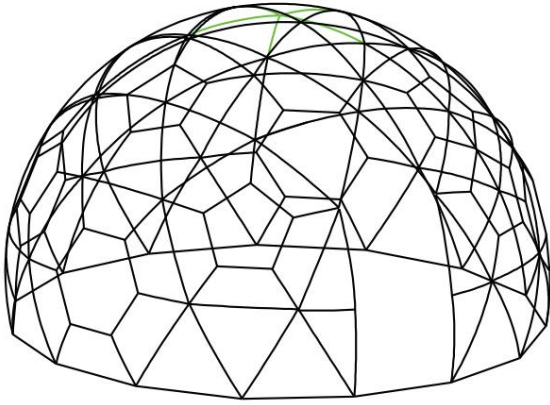

UN  5 pezzi



3x1

Passaggio 13

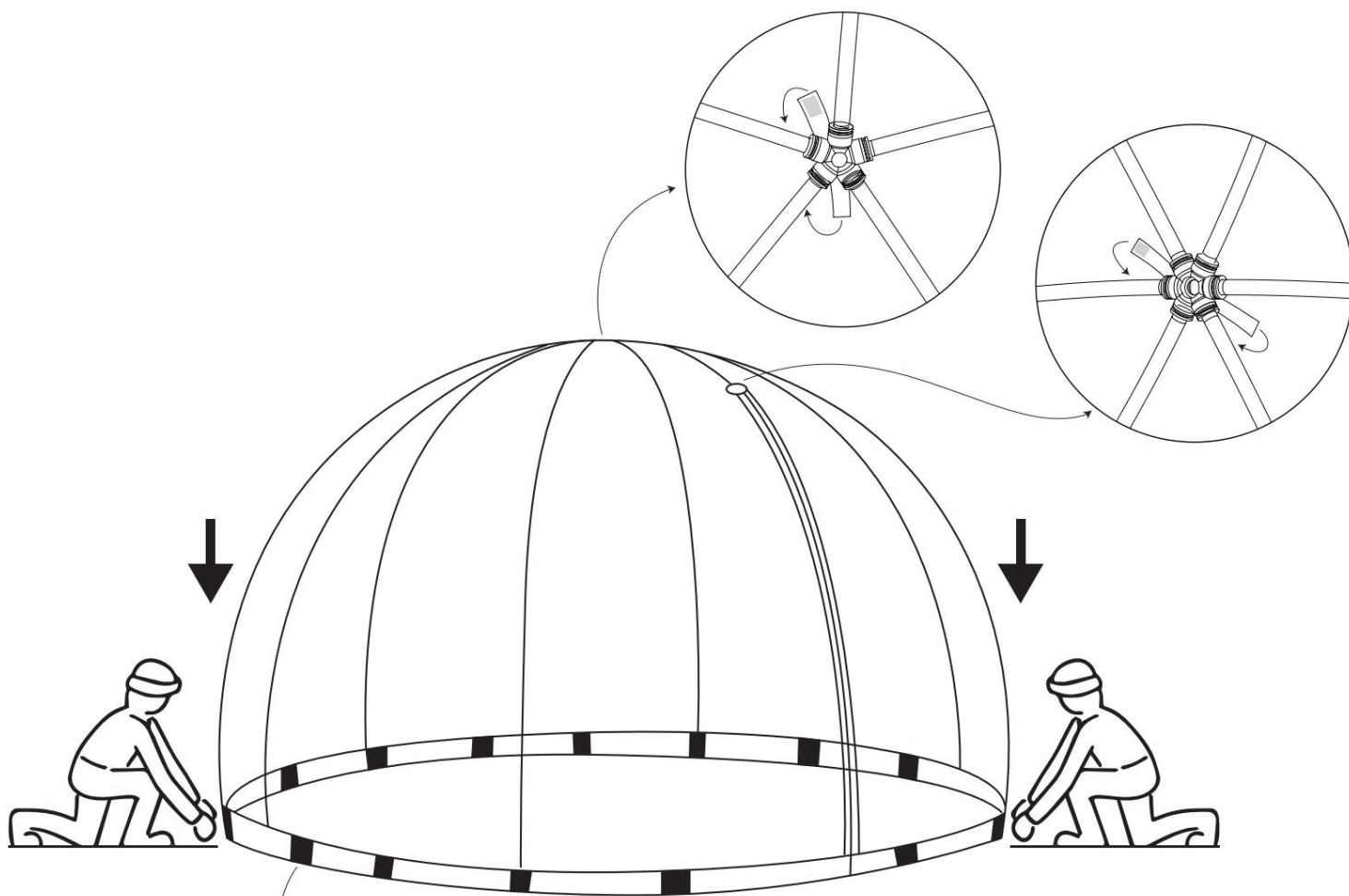

copertura in pvc o copertura antizanzare

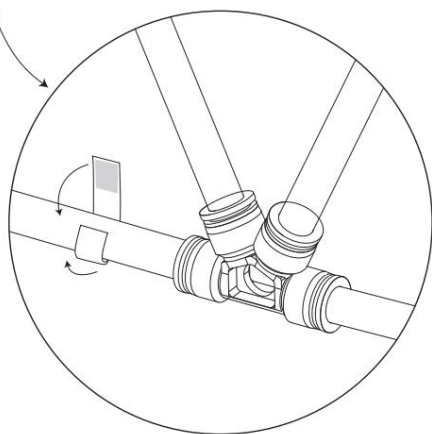

x14

## Passaggio 14

opzione 1

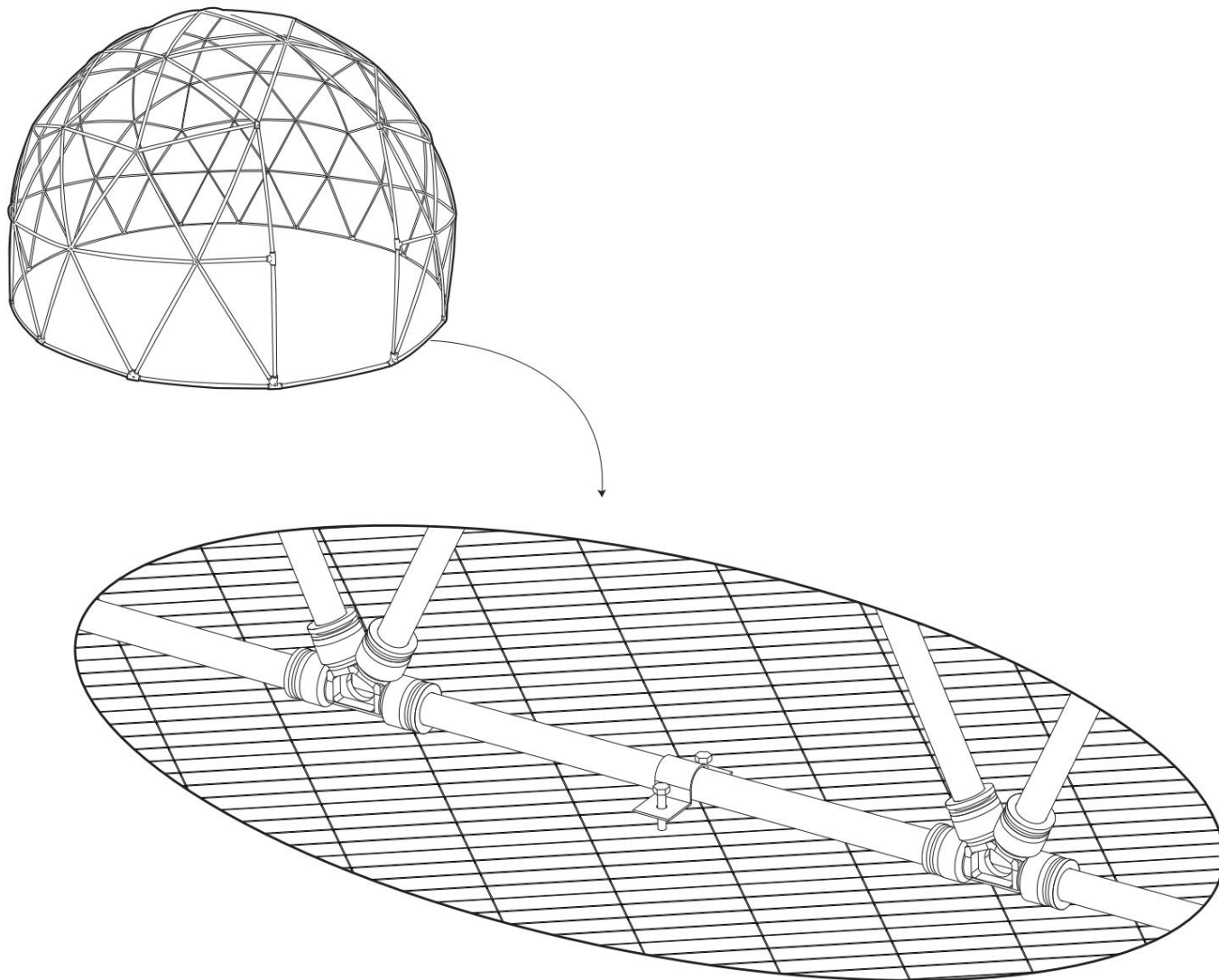

Installare su pavimento in legno/wpc

opzione 2

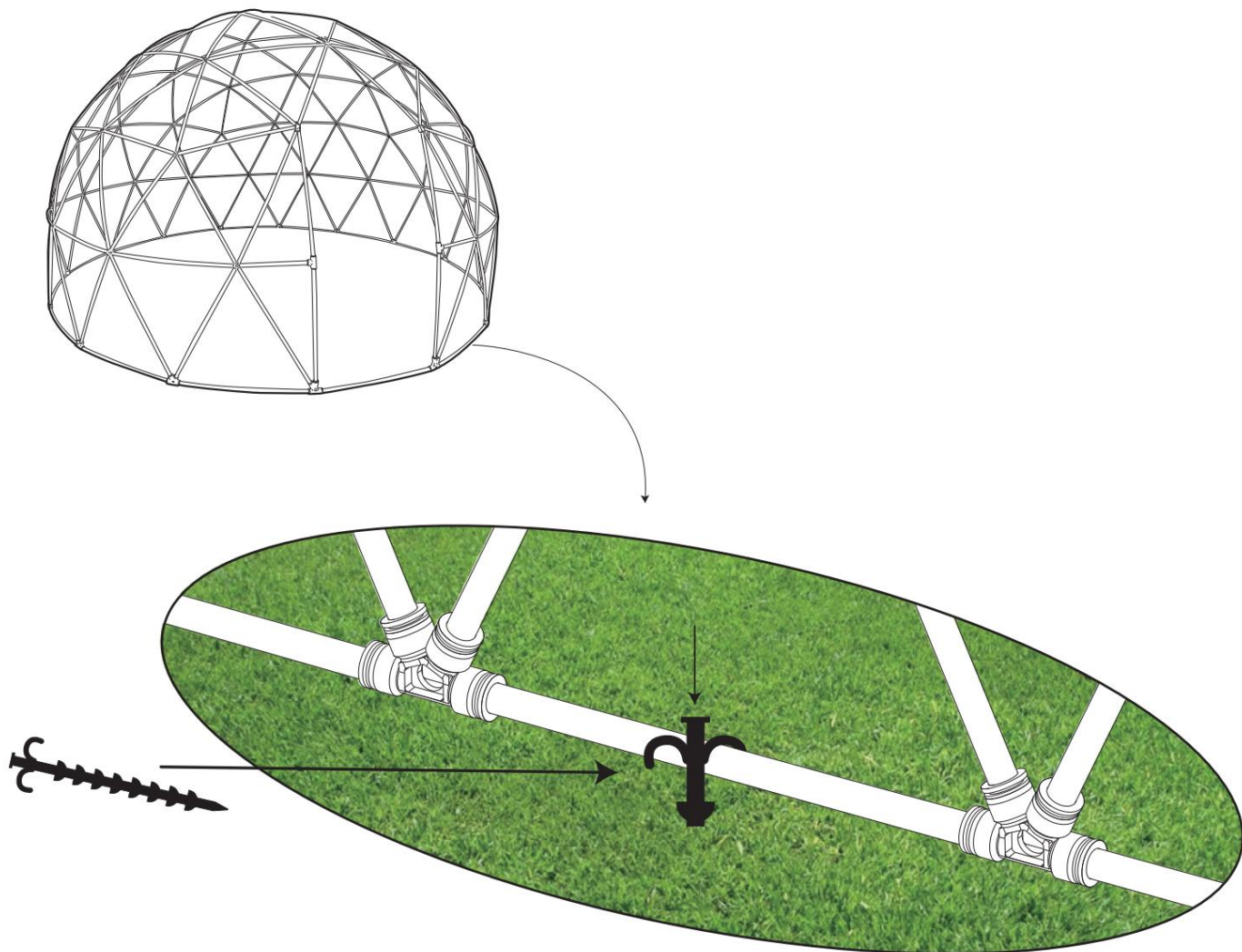

Installare sul pavimento in erba

Opzione 3: sacchetto di sabbia

Attenzione: per evitare la rottura del vento

è necessario il sacchetto di sabbia, 14 pezzi

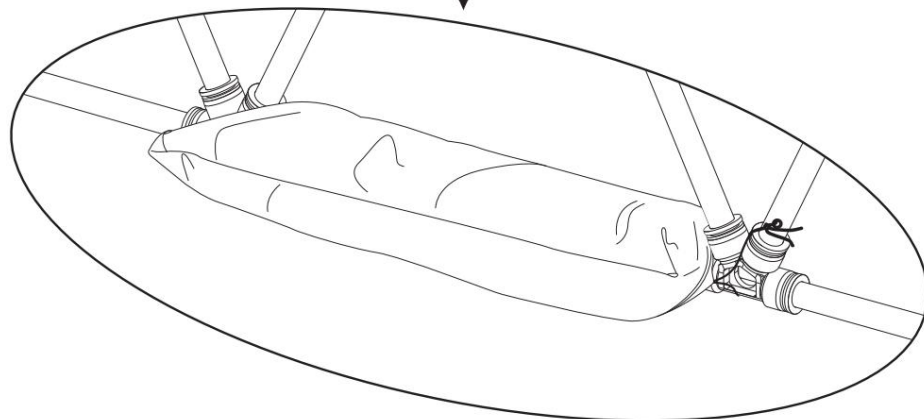
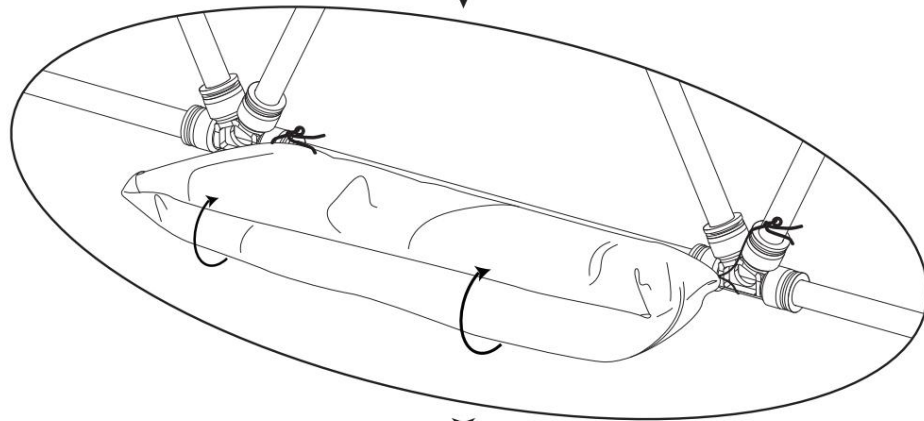
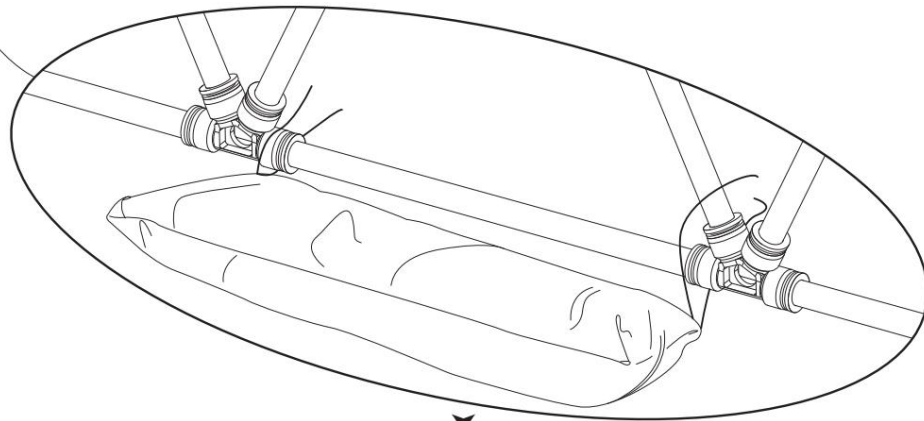
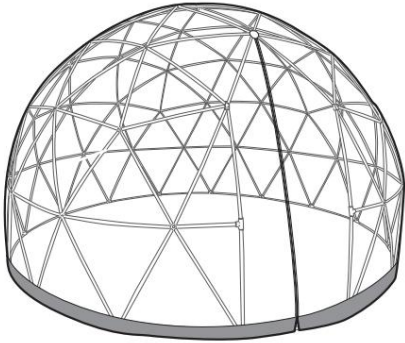

suggerimenti: la copertura in PVC presenterà leggere  
pieghe dopo il primo montaggio. Restare al sole per circa un'ora  
l'ora migliorerà le rughe.



**AVVERTIMENTO**

**CONSERVARE TUTTE LE FONTI DI FIAMMA E CALORE  
LONTANO DA QUESTO TESSUTO A CUPOLA**

**Manufacturer:**Shanghaimuxinmuyeyouxiangongsi

**Address:** Shuangchenglu 803nong11hao1602A-1609shi, baoshanqu, shanghai 200000 CN.

**Imported to AUS:** SIHAO PTY LTD. 1 ROKEVA STREETEASTWOOD NSW 2122 Australia

**Imported to USA:** Sanven Technology Ltd. Suite 250, 9166 Anaheim Place, Rancho Cucamonga, CA 91730



E-CrossStu GmbH  
Mainzer Landstr.69, 60329 Frankfurt am Main.



YH CONSULTING LIMITED.  
C/O YH Consulting Limited Office 147, Centurion House,  
London Road, Staines-upon-Thames, Surrey, TW18 4AX



**VEVOR**<sup>®</sup>

**TOUGH TOOLS, HALF PRICE**

Technical Support and E-Warranty Certificate

[www.vevor.com/support](http://www.vevor.com/support)

# VEVOR<sup>®</sup>

## TOUGH TOOLS, HALF PRICE

Technical Support and E-Warranty Certificate [www.vevor.com/support](http://www.vevor.com/support)

### OGRÓD ZEWNĘTRZNY CZYSTY DOOM

### INSTRUKCJA OBSŁUGI

Nadal dokładamy wszelkich starań, aby zapewnić Państwu narzędzia w konkurencyjnej cenie. „Zaoszczędź o połowę”, „o połowę ceny” lub inne podobne wyrażenia używane przez nas przedstawiają jedynie szacunkową oszczędność, jaką możesz zyskać kupując u nas określone narzędzia w porównaniu z głównymi najlepszymi markami i niekoniecznie oznaczają uwzględnienie wszystkich kategorii oferowanych narzędzi przez nas. Przypominamy, aby podczas składania zamówienia u nas dokładnie sprawdzić, czy faktycznie oszczędzasz połowę w porównaniu z czołowymi markami.

# VEVOR®

TOUGH TOOLS, HALF PRICE

OGRÓD NA ZEWNĄTRZ CZYSTY  
LOS

Model: GB-DOME-12, GB-DOME-12T, GB-DOME-9,5 GB-DOME-9,5T

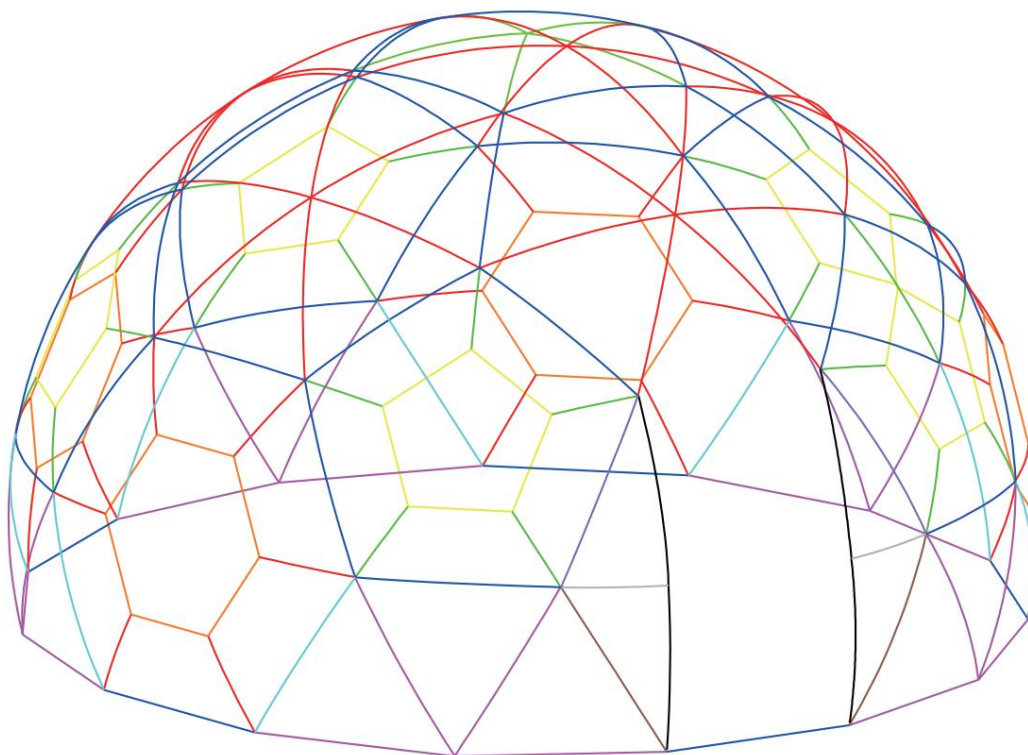

POTRZEBUJĘ POMOCY? SKONTAKTUJ SIĘ Z NAMI!

Masz pytania dotyczące produktu? Potrzebujesz wsparcia technicznego? Prosimy o kontakt: Wsparcie techniczne i certyfikat e-gwarancji [www.vevor.com/support](http://www.vevor.com/support)

To jest oryginalna instrukcja. Przed przystąpieniem do obsługi prosimy o dokładne zapoznanie się ze wszystkimi instrukcjami. VEVOR zastrzega sobie jasną interpretację naszej instrukcji obsługi. Wygląd produktu zależy od produktu, który otrzymałeś. Proszę wybaczyć nam, że nie będziemy ponownie informować Państwa, jeśli pojawią się jakieś aktualizacje technologii lub oprogramowania naszego produktu.

## SPECYFIKACJE

Model	GB-DOME-12
Rozmiar produktu	12 stóp
Kolor	Przezroczysty
Ładowność	110 funtów

Model	GB-DOME-12T
Rozmiar produktu	12 stóp
Kolor	Przezroczysty
Ładowność	110 funtów

Model	GB-DOME-9.5
Rozmiar produktu	9,5 stopy
Kolor	Przezroczysty
Ładowność	110 funtów







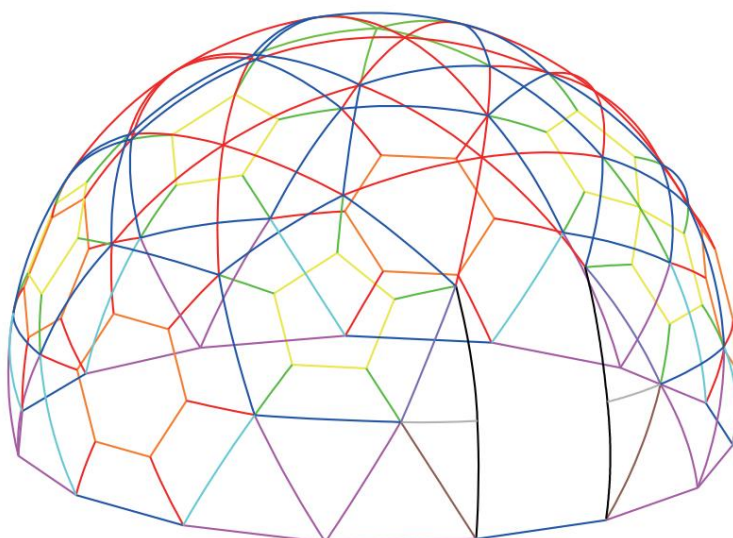

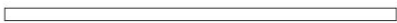
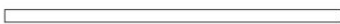

Model	GB-DOME-9,5T
Rozmiar produktu	9,5 stopy
Kolor	Przezroczysty
Ładowność	110 funtów

# Akcesoria

Model	Przezroczysta osłona z PCV	Osłona na komary
GB-DOME-12	✓	×
GB-DOME-12T	✓	✓
GB-DOME-9.5	✓	×
GB-DOME-9,5T	✓	✓

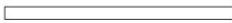

Rury :

- A  5szt
- B  42szt
- C  50szt
- D  4szt
- mi  8 szt
- G  2 szt
- H  2 szt
- I  2 szt
- J  25szt
- K  25szt
- L  24szt
- M  24szt

Okładka:

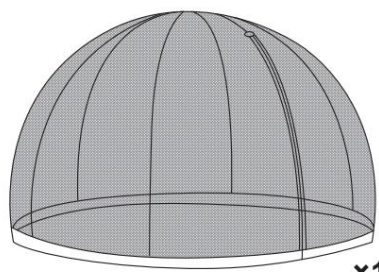
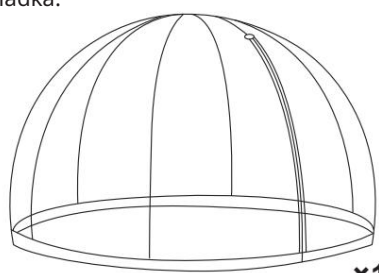

Standardowe oceny:



9,5 stopy

12FT

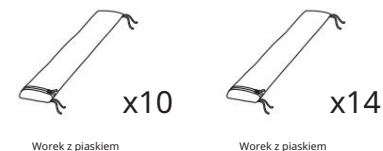

Złącza:

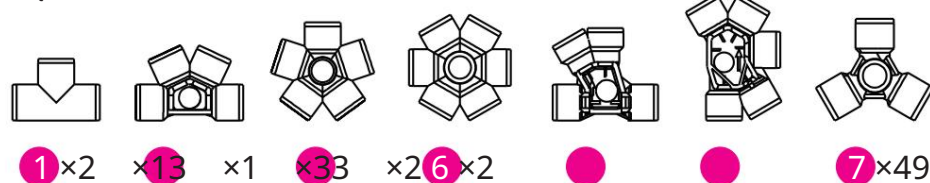

# Krok 01

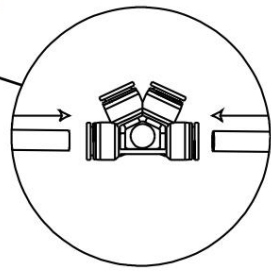
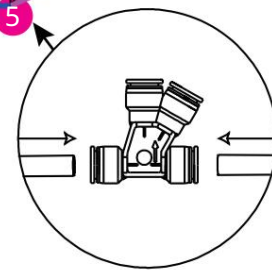
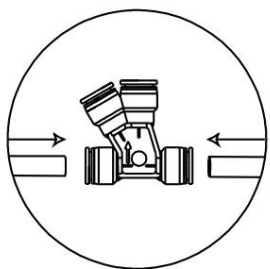
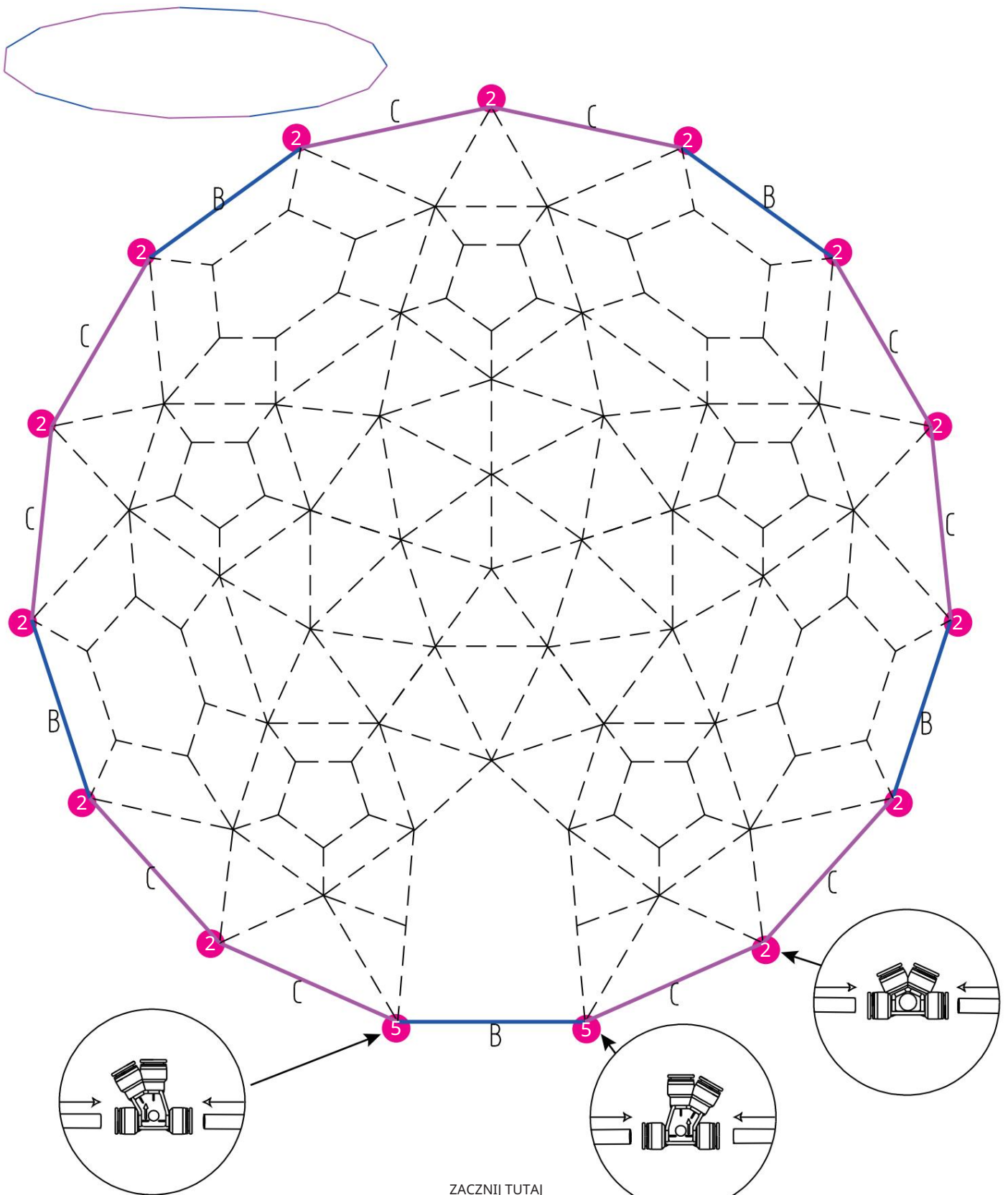

ZACZNIJ TUTAJ

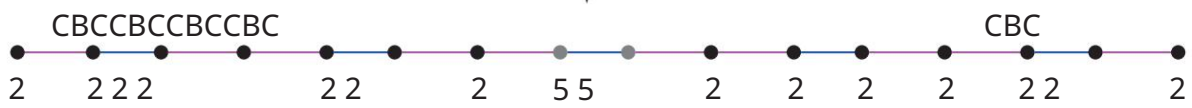

CBCCBCCBCCBC

CBC

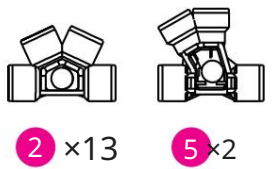
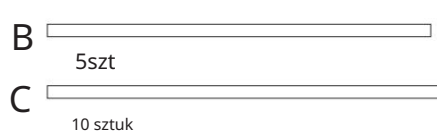

# Krok 02

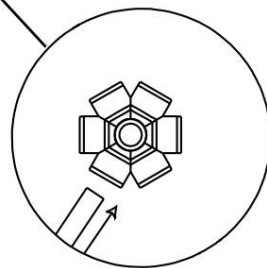
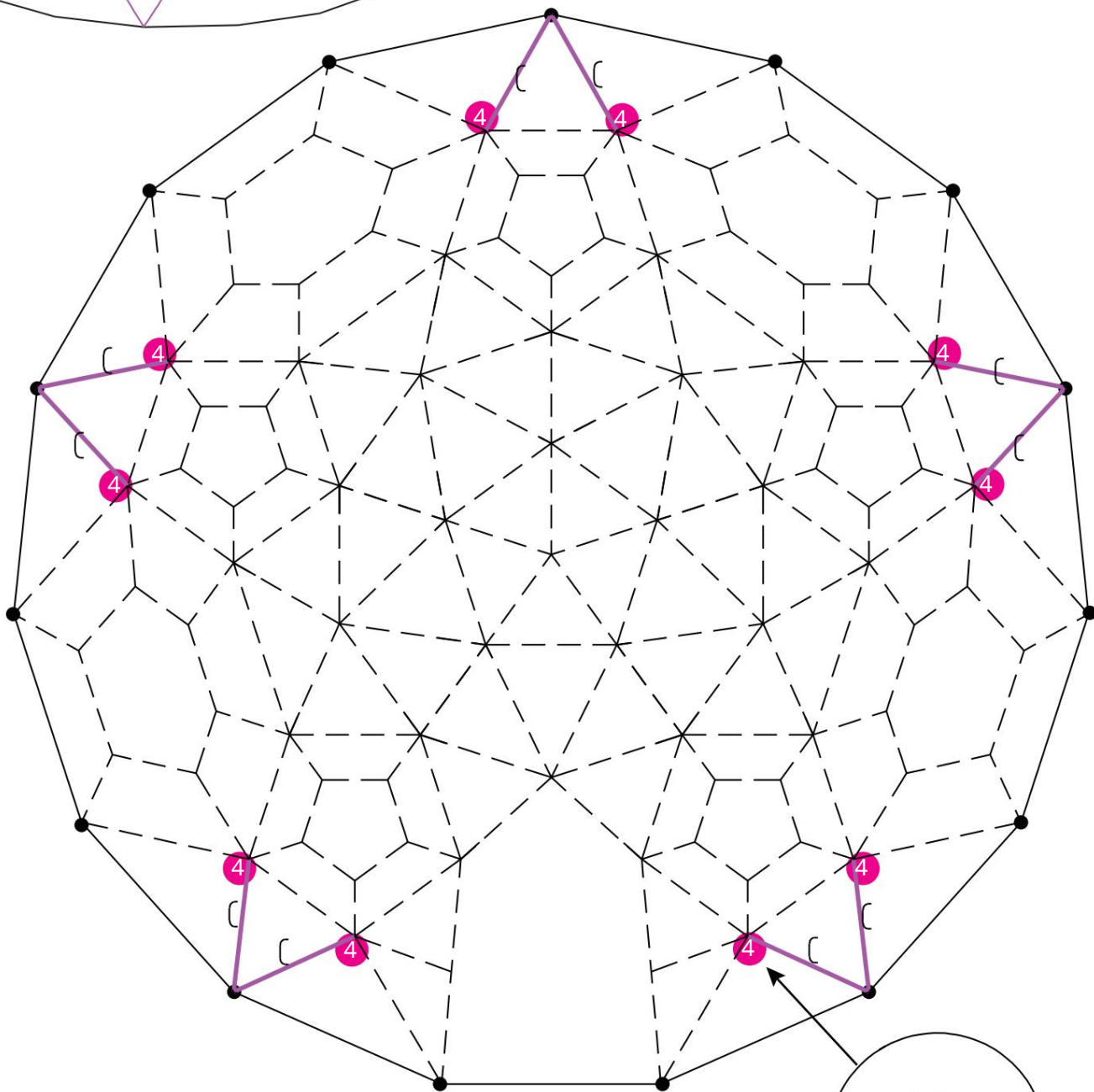
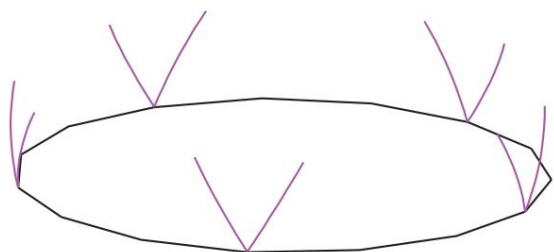

C  10 sztuk



4 x 10

# Krok-03

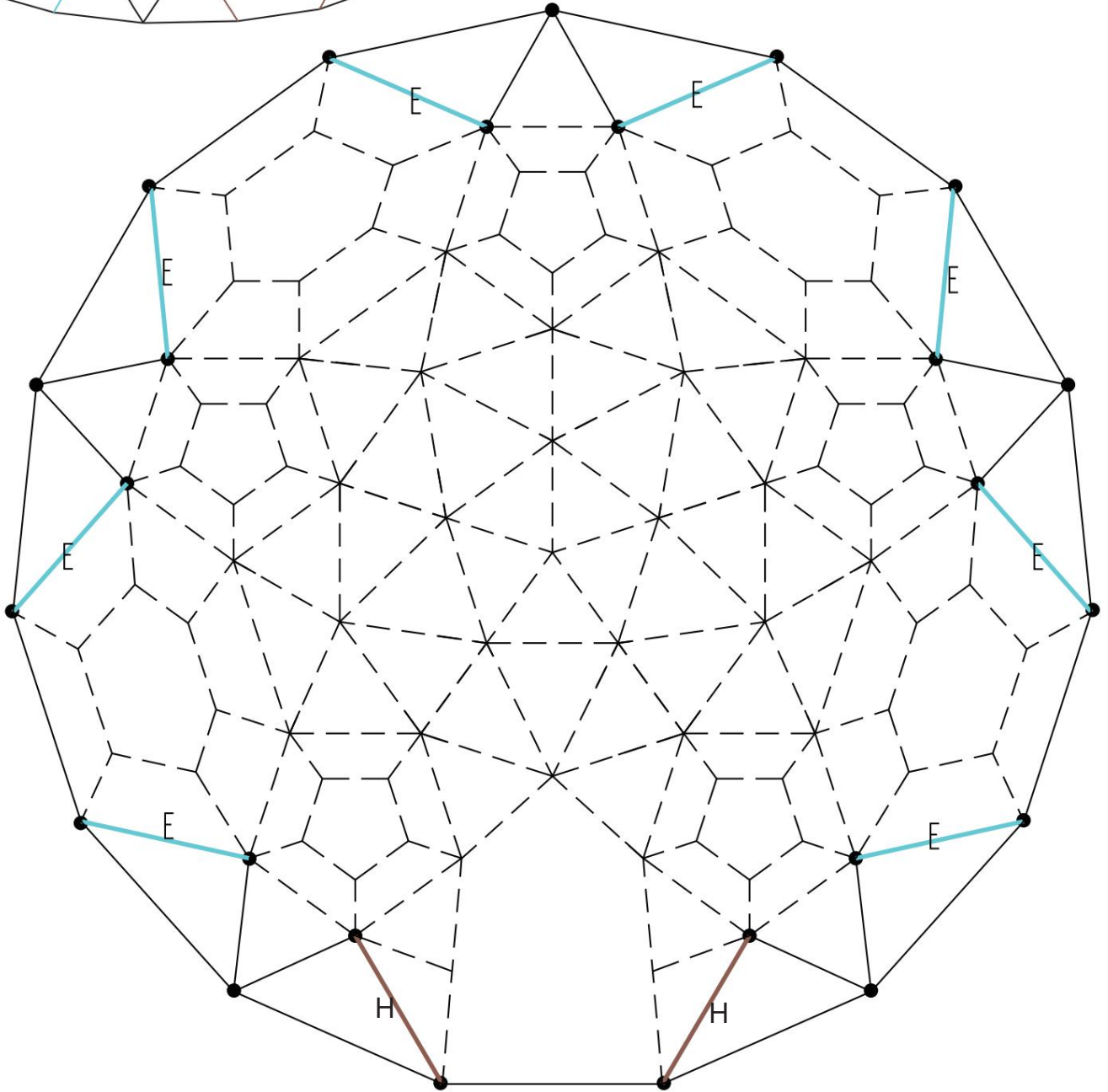
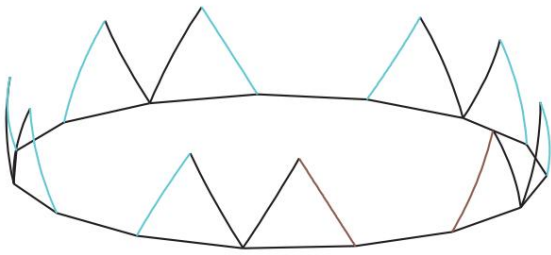

mi  8 szt

H  2 szt



# Krok-04

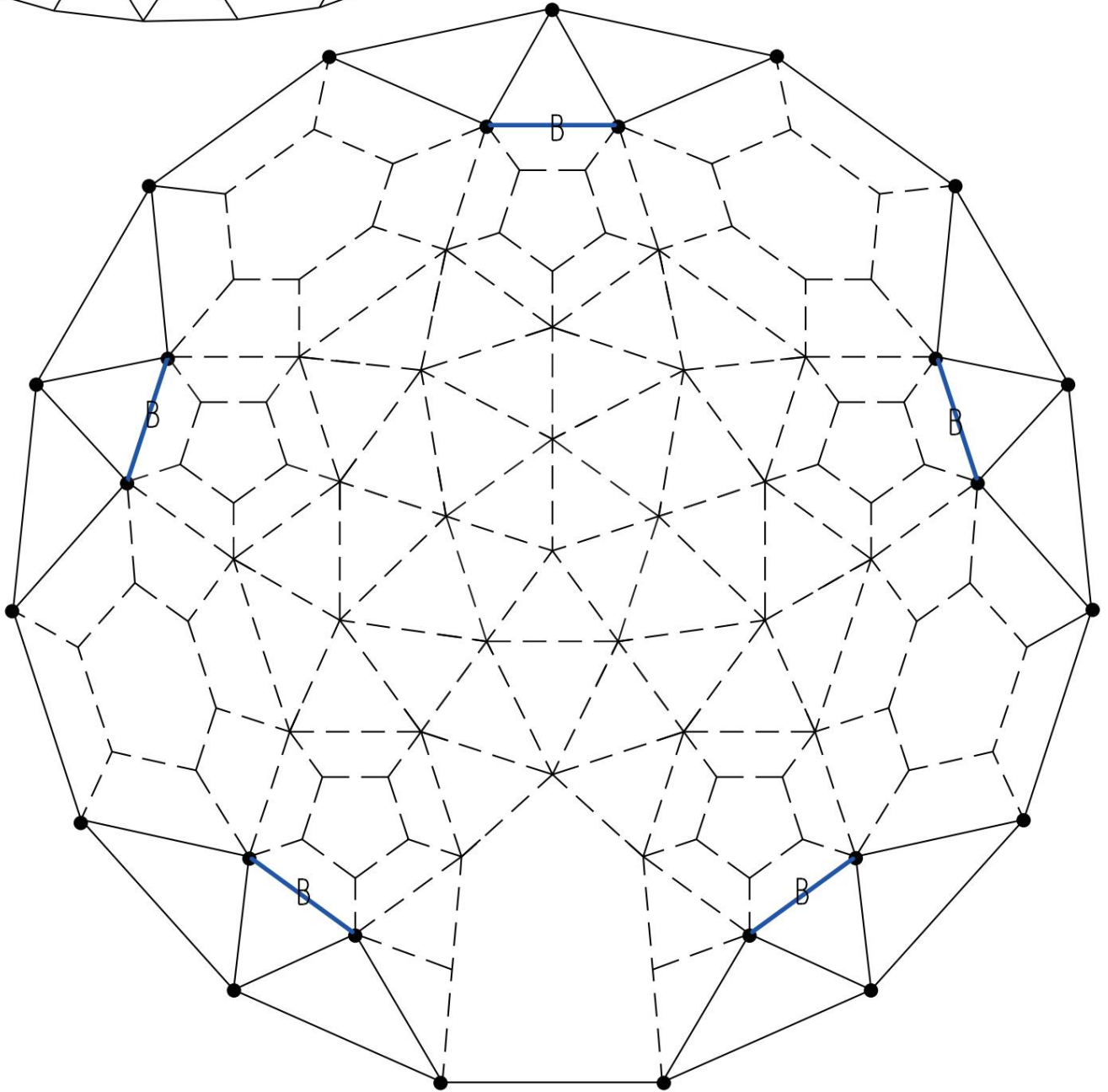
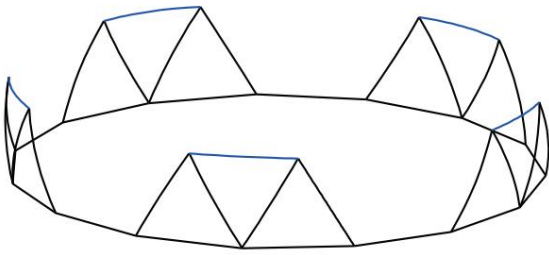



B   
5szt

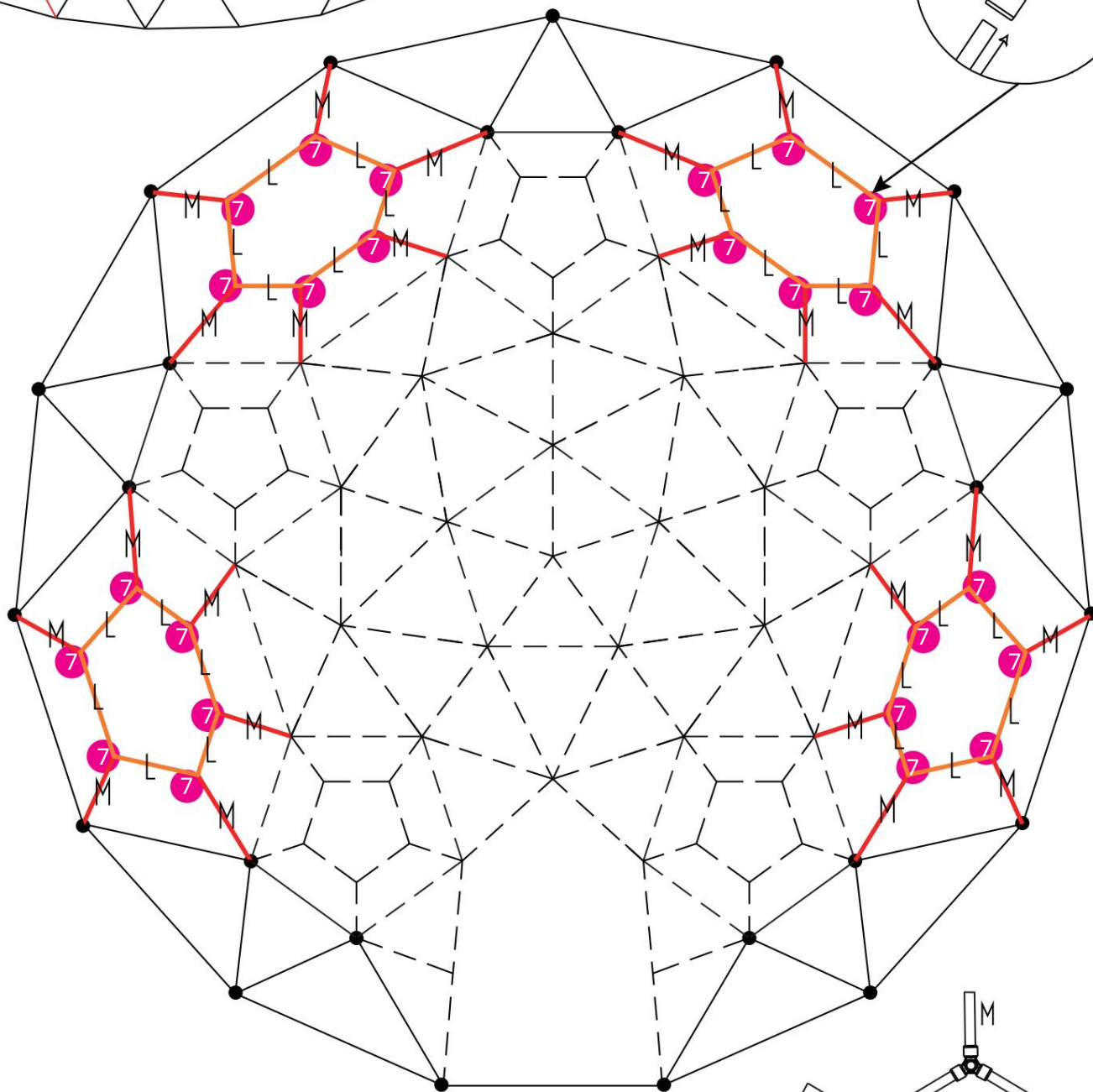
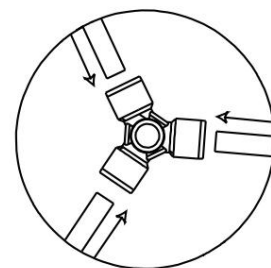
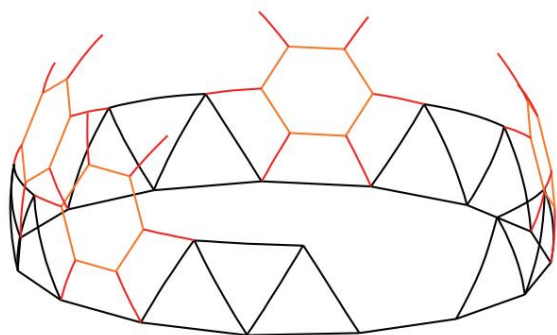

# Krok-05



L  24szt  
M  24szt



7 x 24

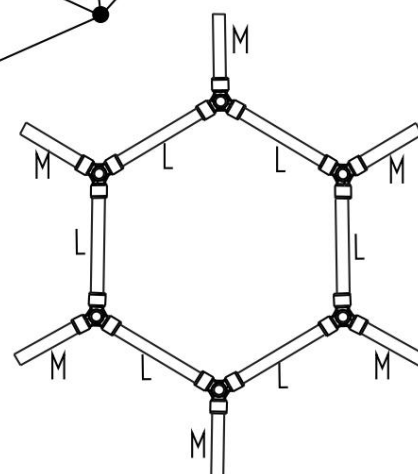

# Krok-06

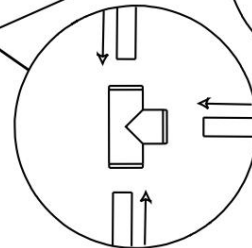
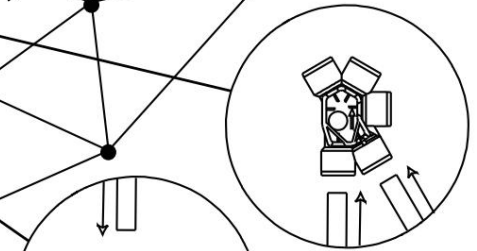
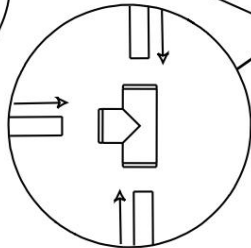
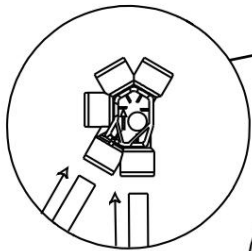
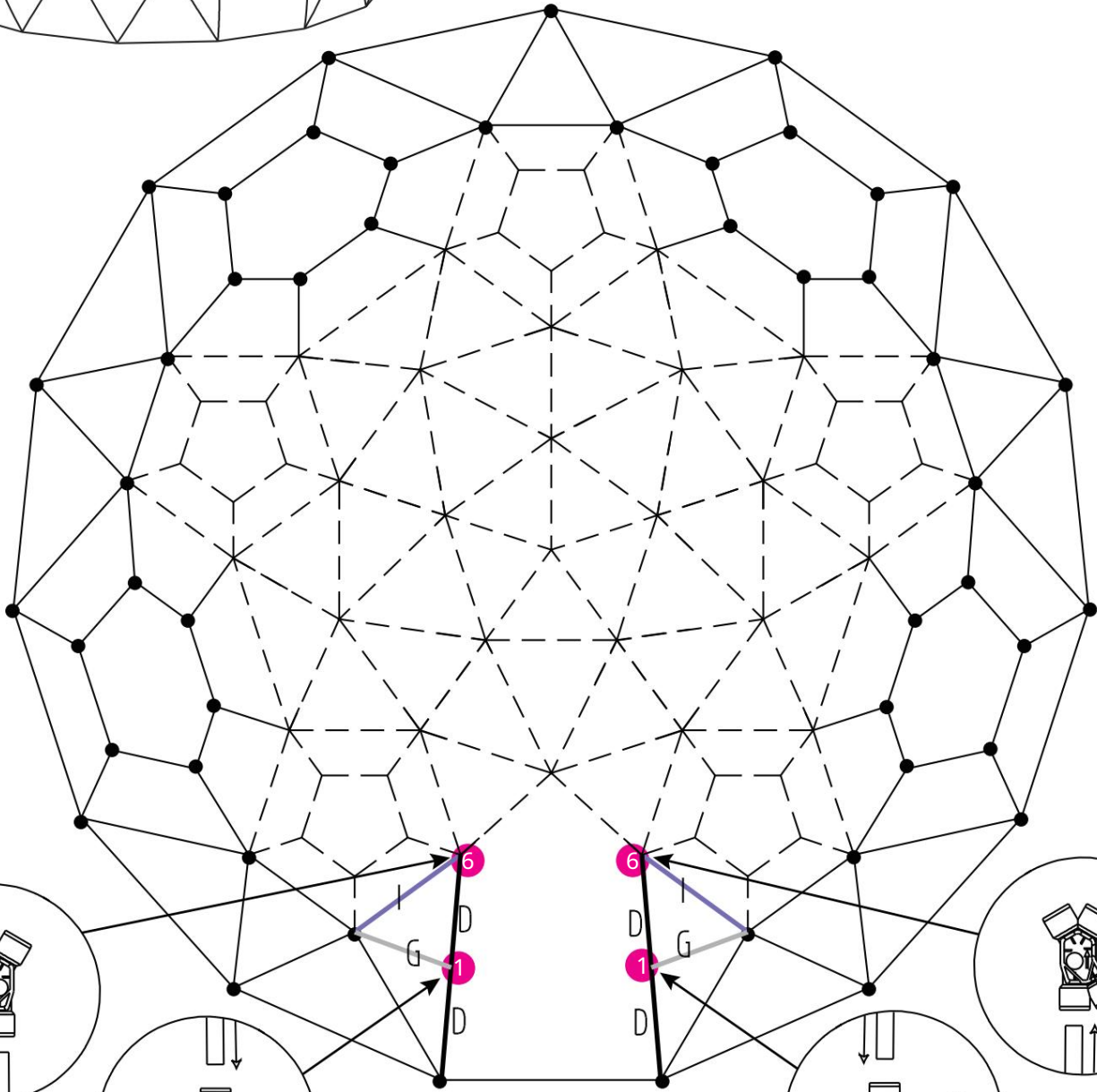
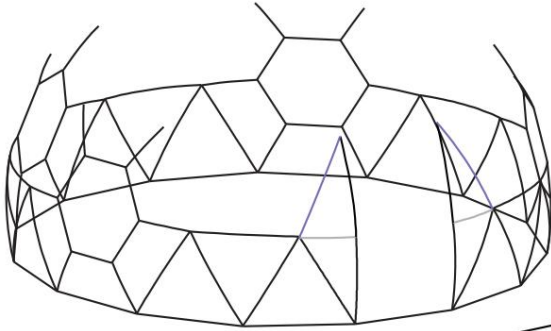

D   
4szt

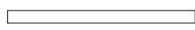
G   
2 szt

I   
2 szt

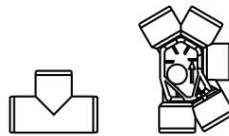

1 x 2

x 2

# Krok-07

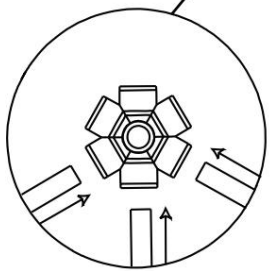
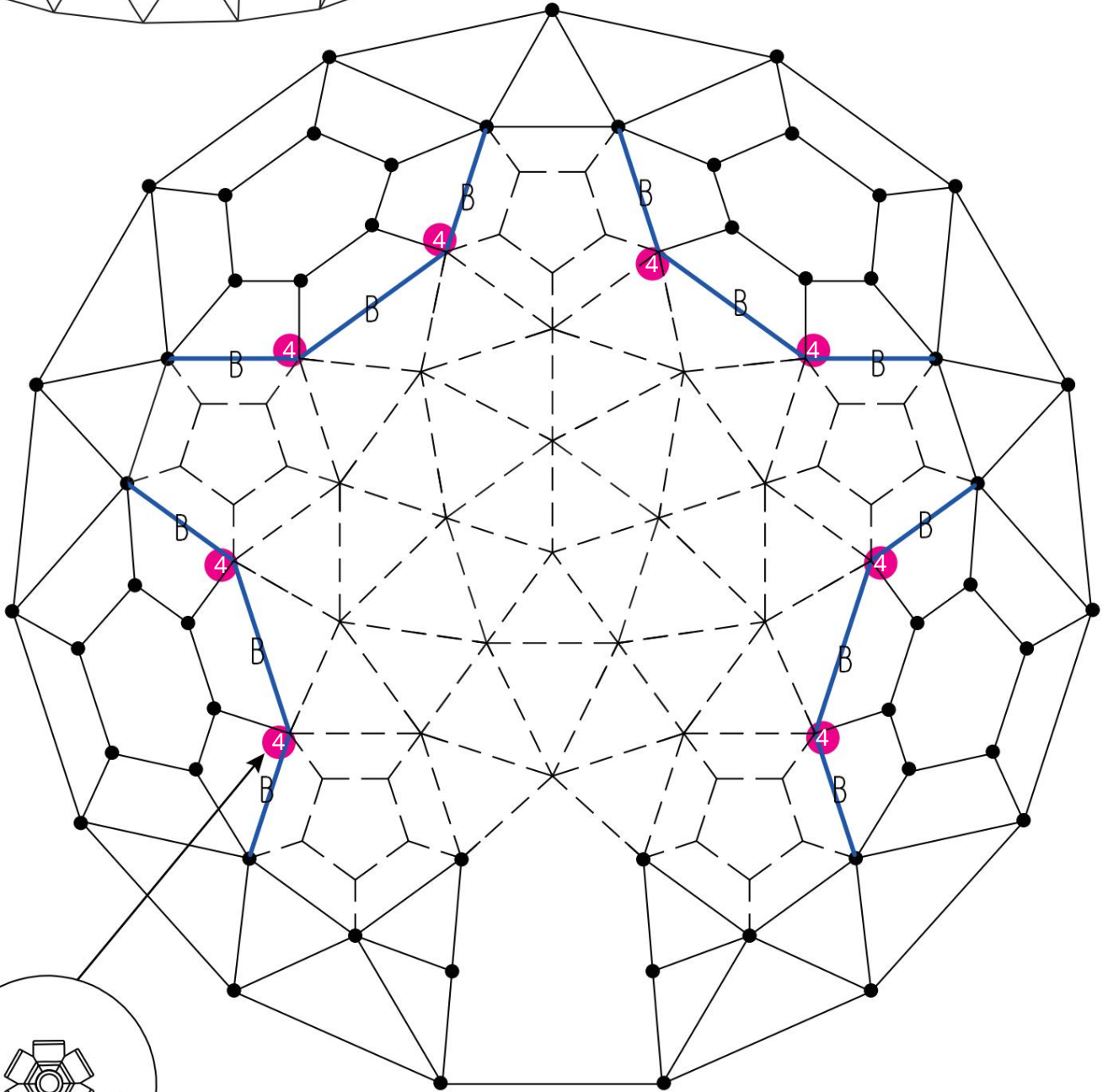
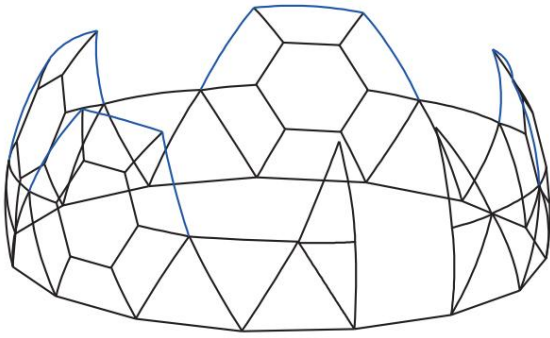

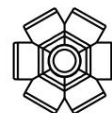

B  12szt

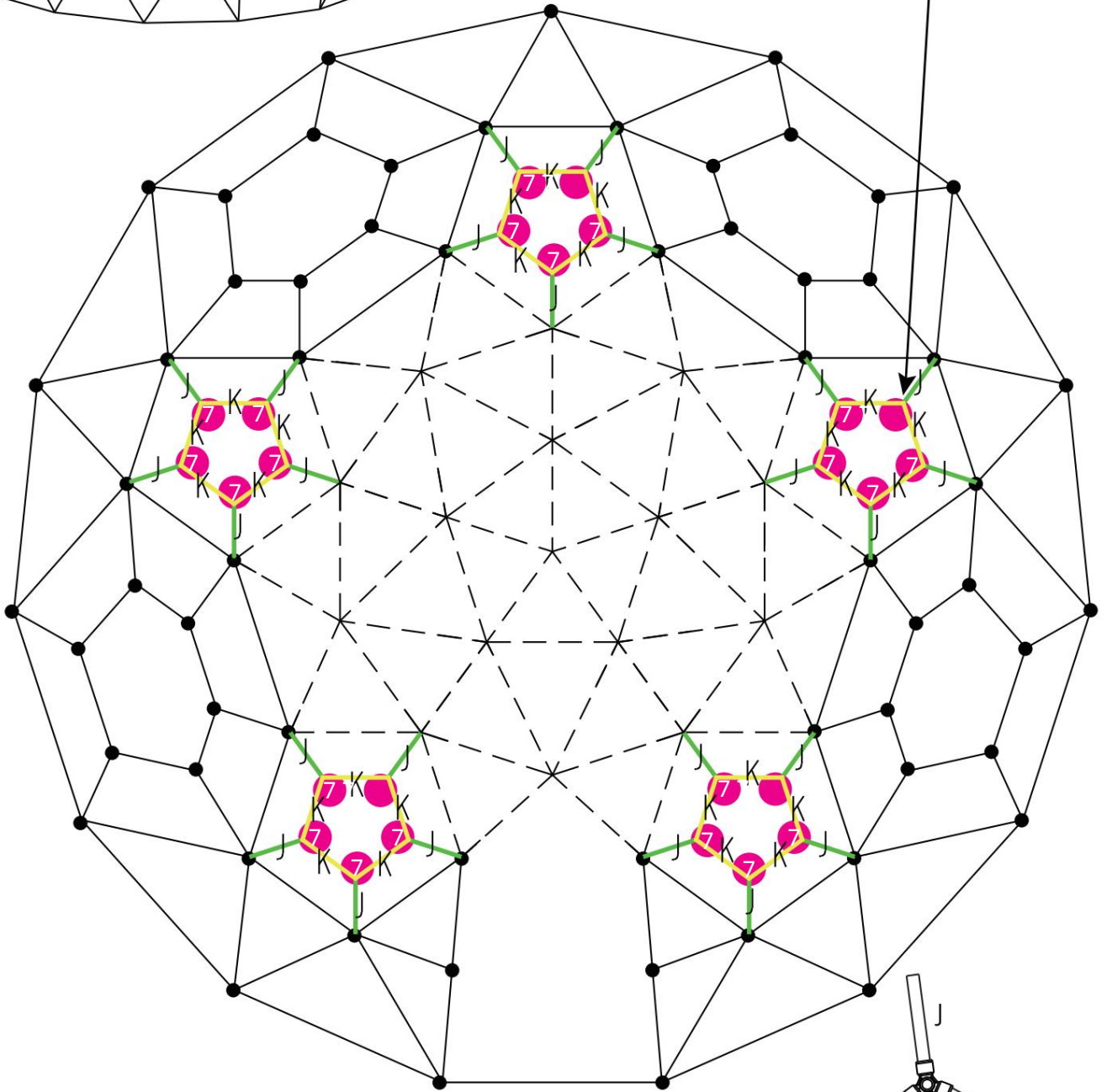
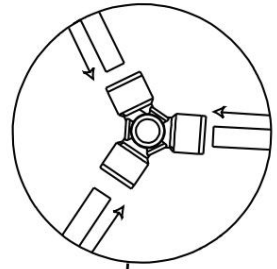
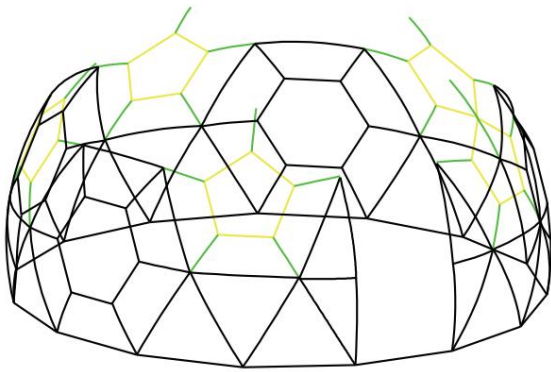

4 x 8

# Krok-08



J  25szt  
K  25szt



 x25

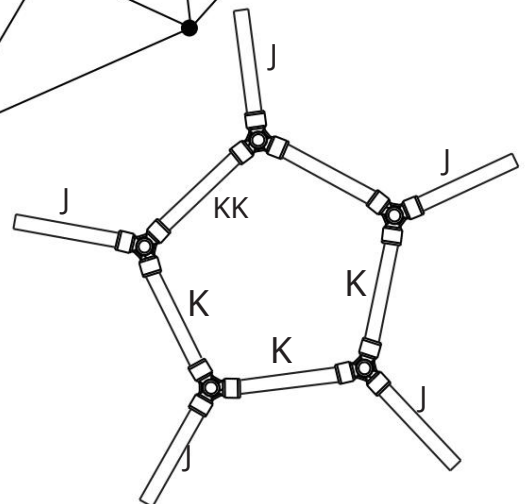

# Krok-09

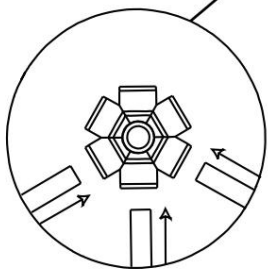
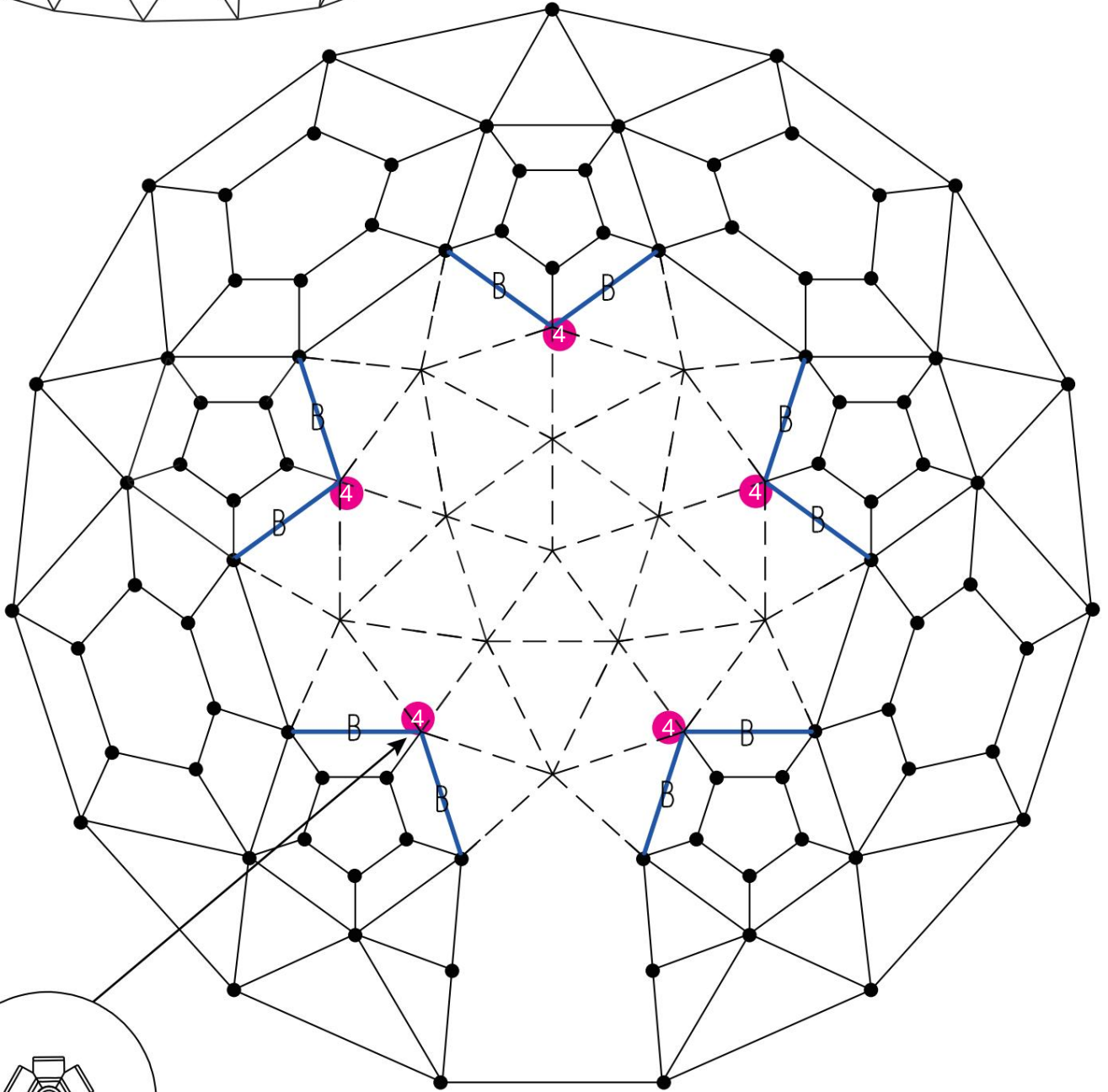
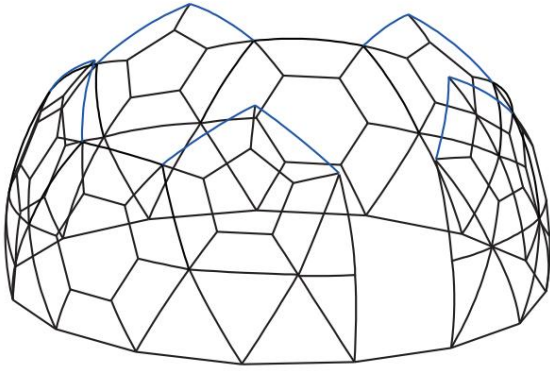

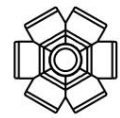

B  10 sztuk

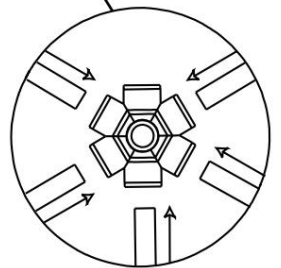
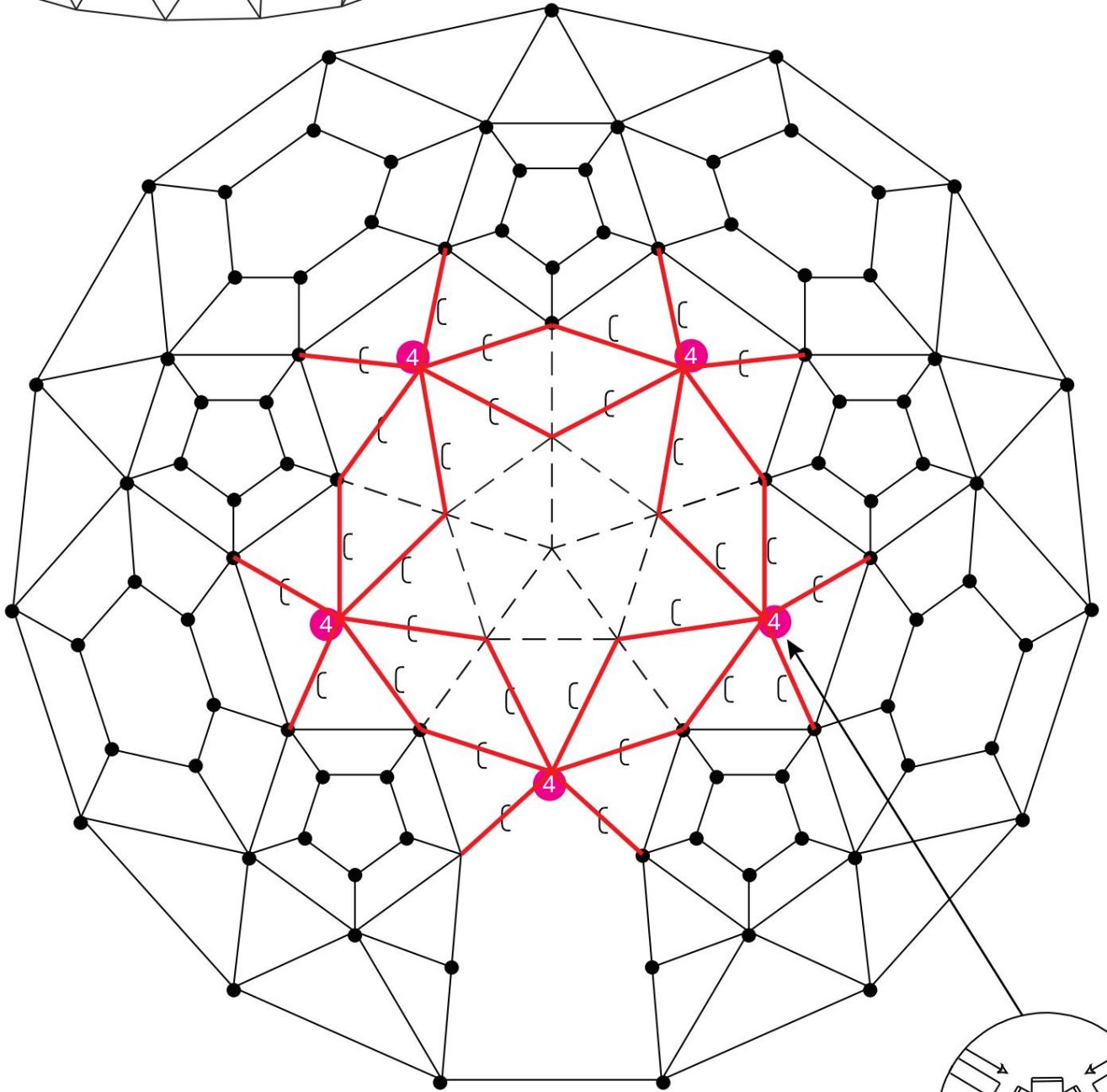
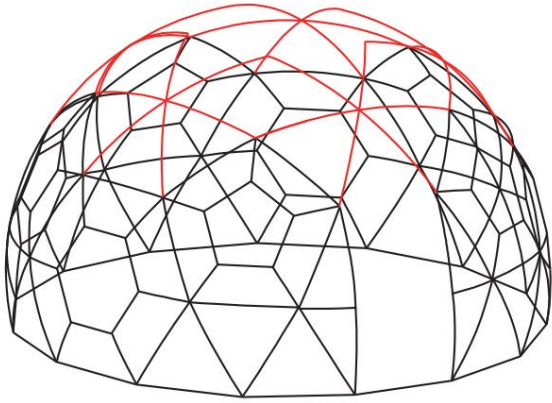

4 x5

# Krok 10



C   
71 cm / 30szt

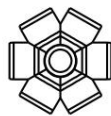

4 x5

# Krok 11

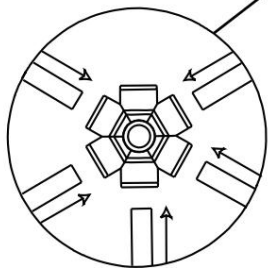
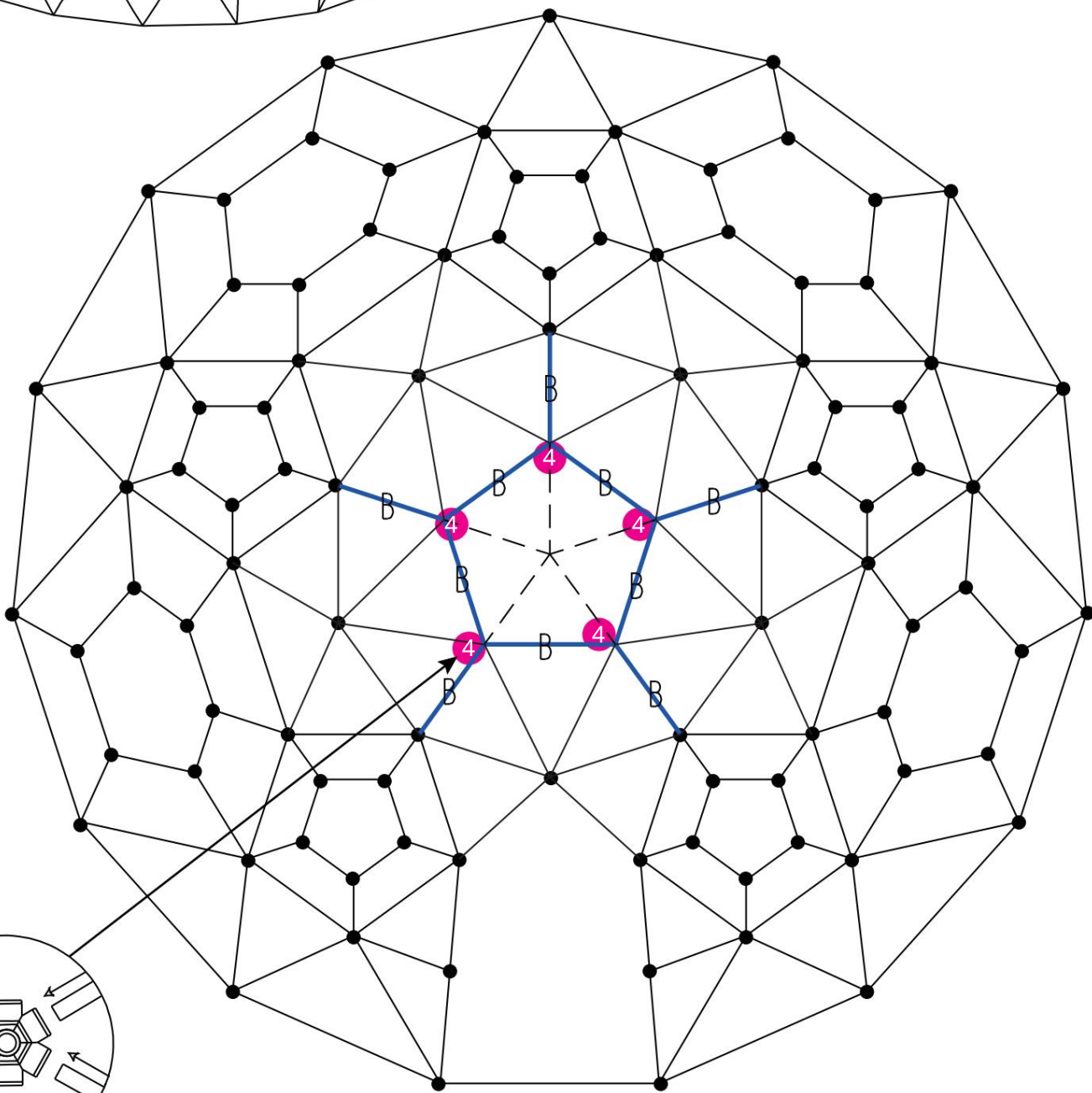
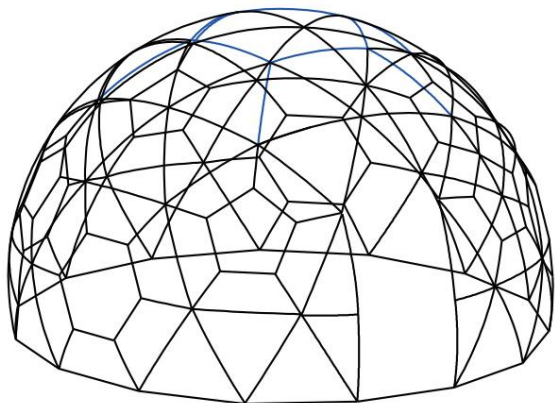



B   
10 sztuk

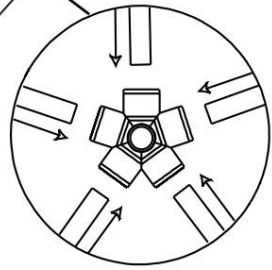
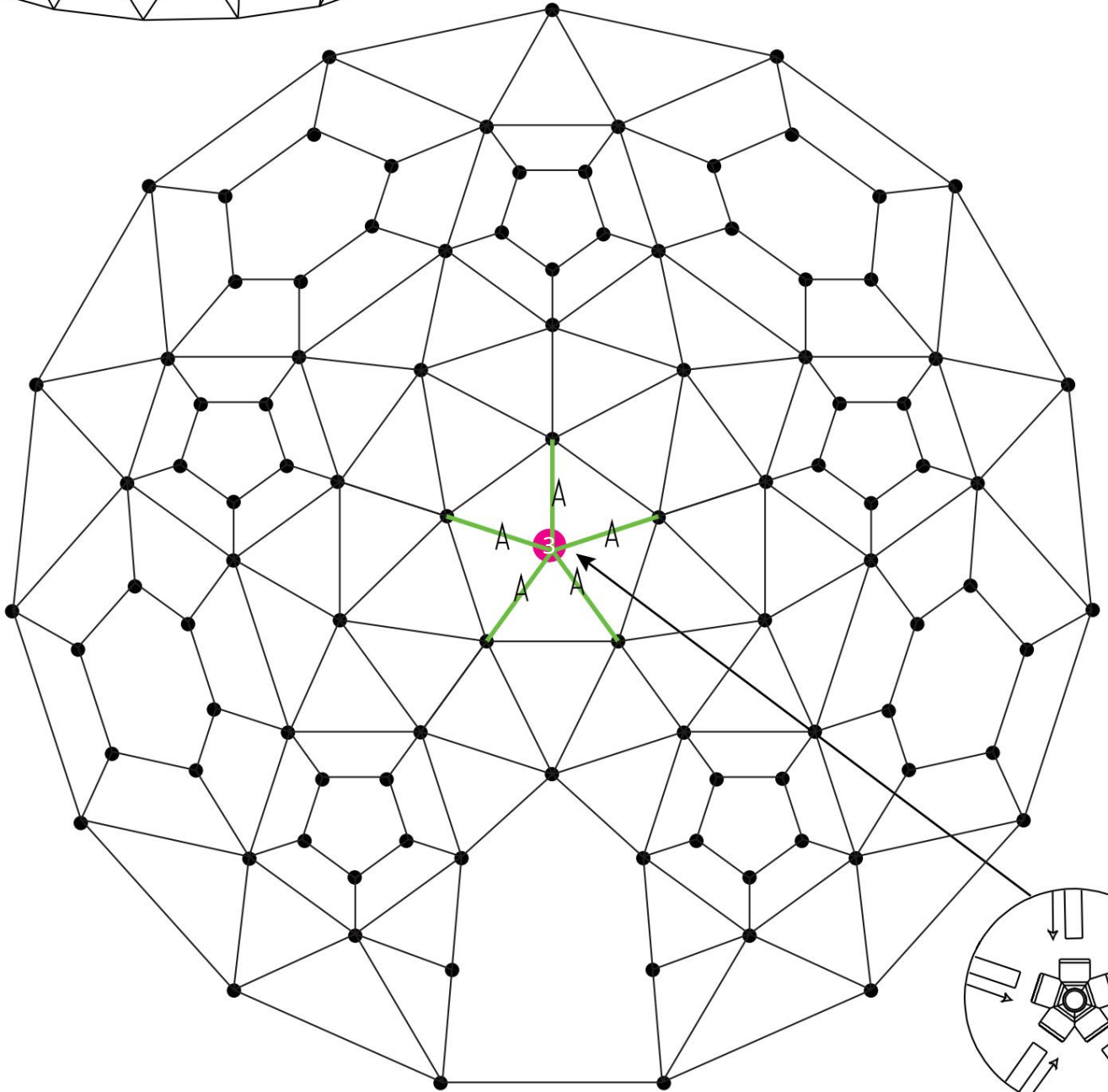
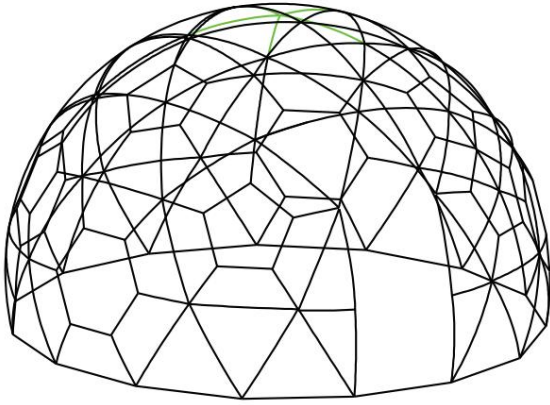

4 x 5

# Krok 12



A  5szt

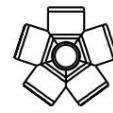

3x1

# Krok 13

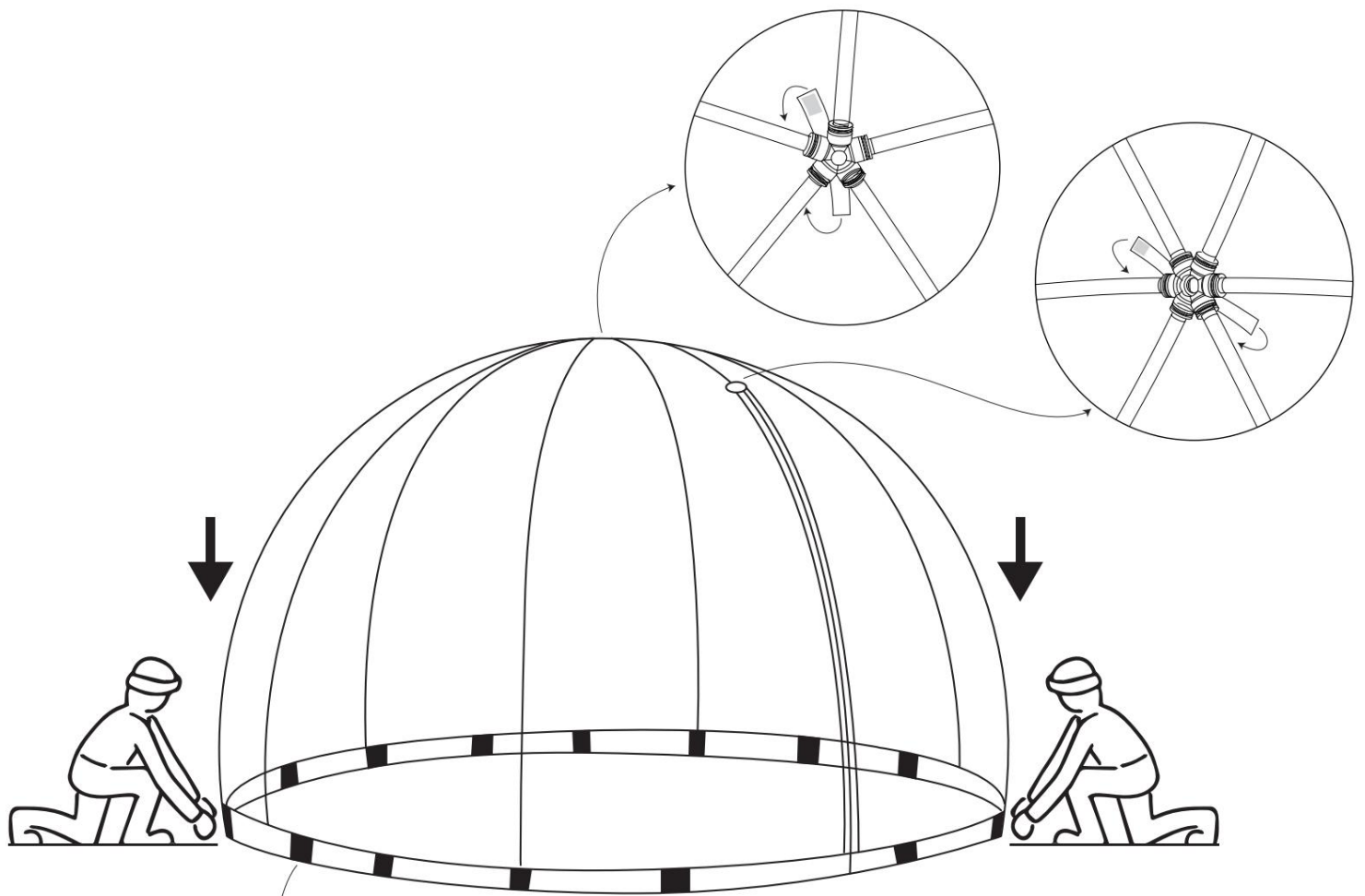

osłona PCV lub osłona na komary

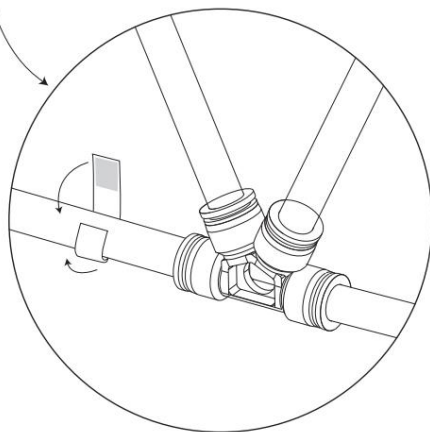

x 14

# Krok 14

opcja 1

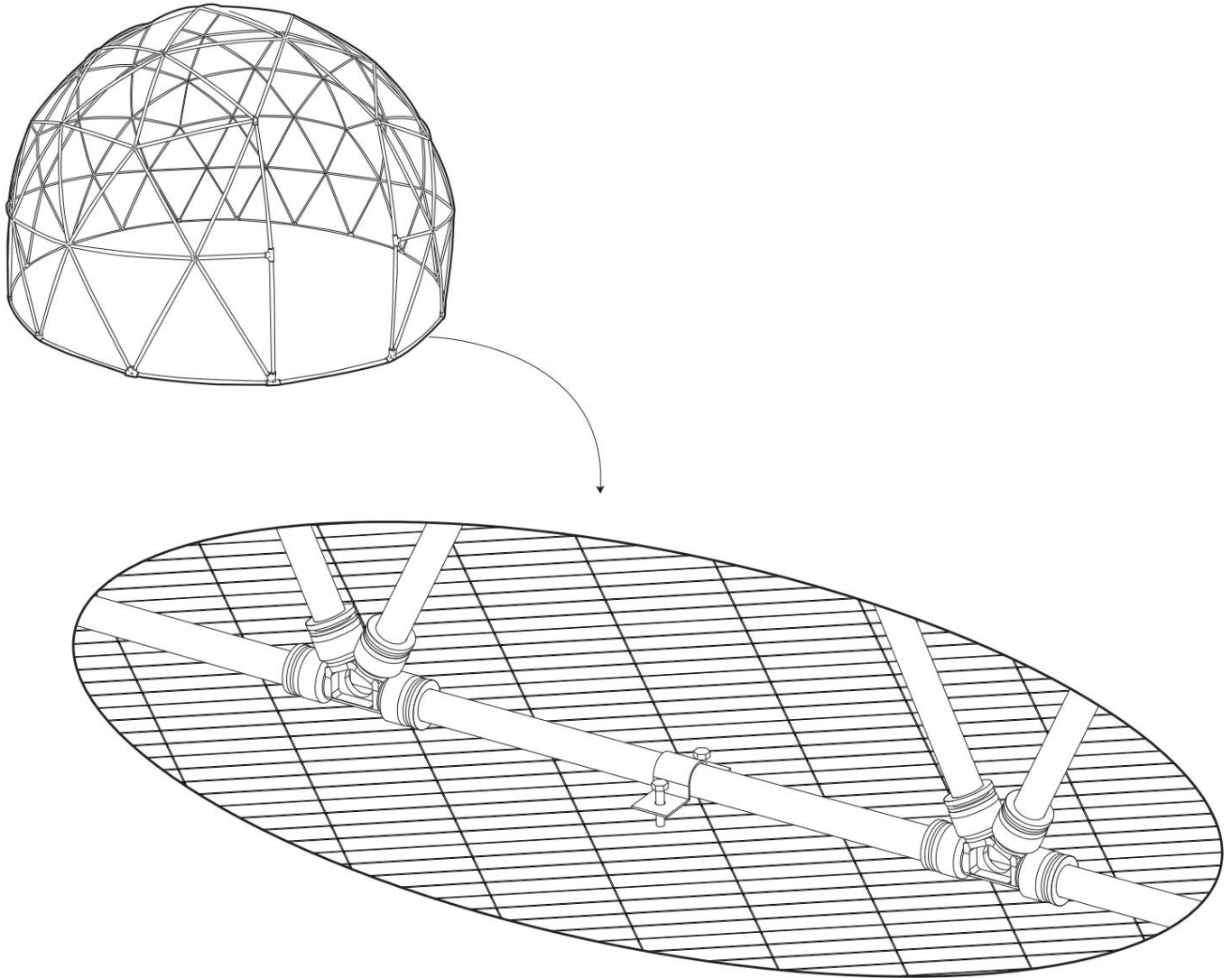

Zainstaluj na podłodze drewnianej/wpc

# Krok 15

Opcja 2

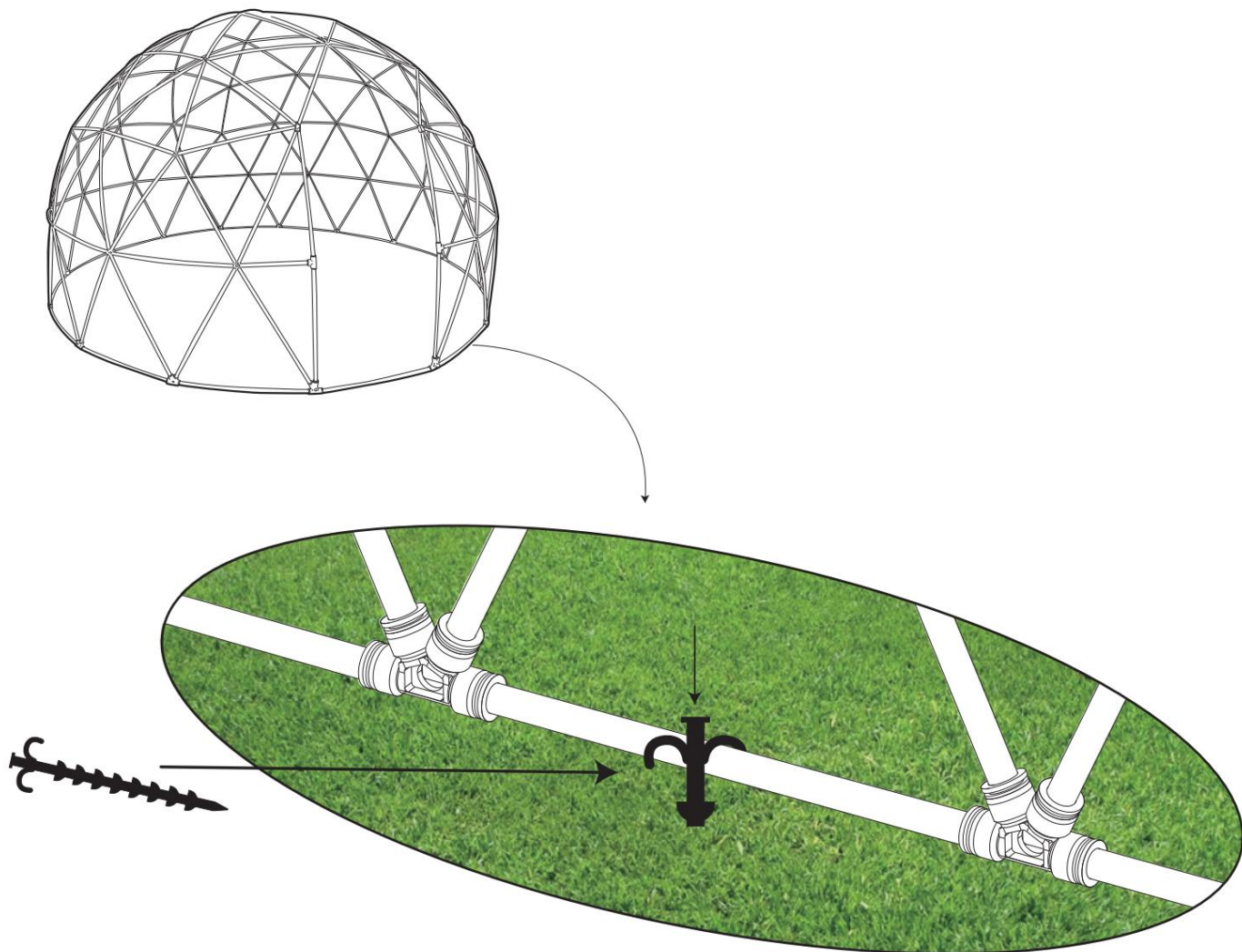

Zainstaluj na podłodze z trawy

# Krok 16

Opcja 3: worek z piaskiem

Uwaga: aby uniknąć załamania wiatru,  
niezbędny jest worek z piaskiem, 14 szt

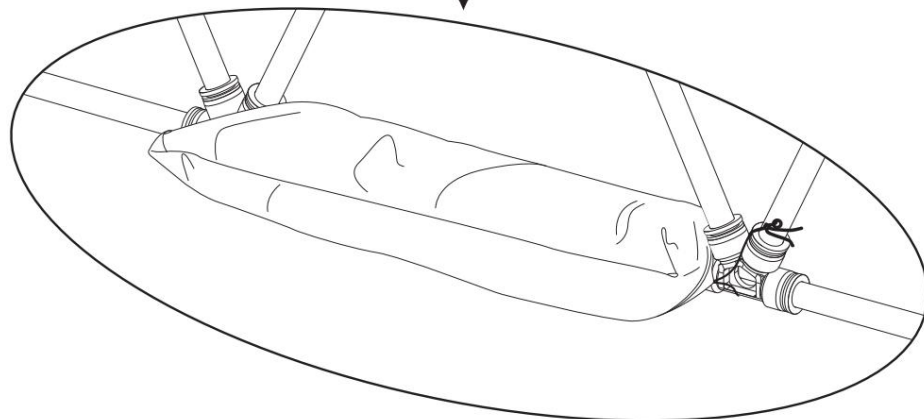
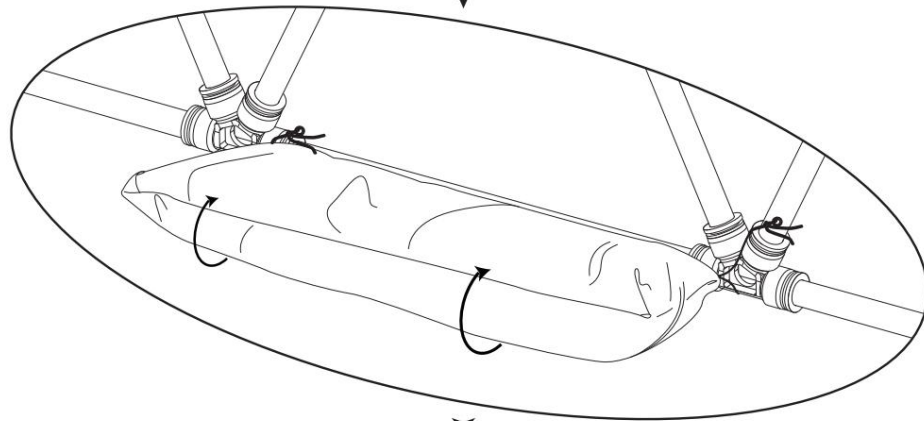
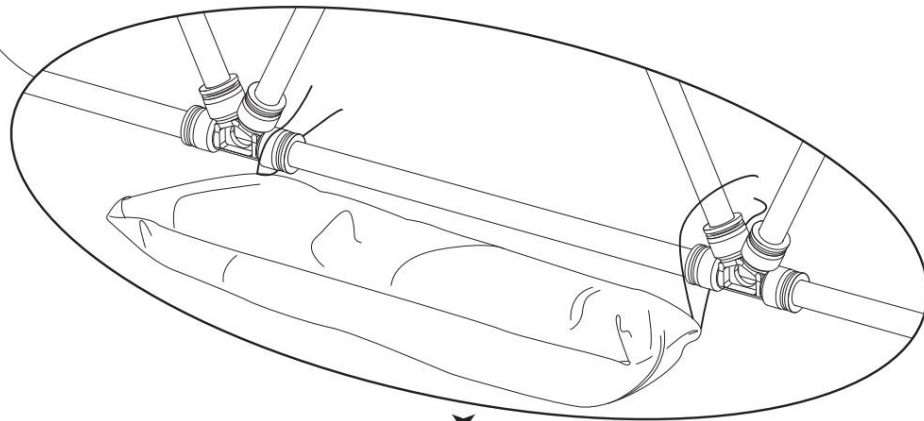
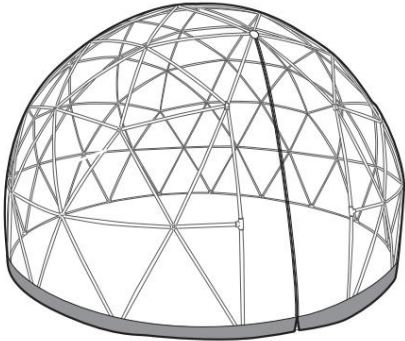

# Krok 17

Wskazówki: Pokrowiec PCV będzie miał delikatne zmarszczki już po pierwszym montażu. Przebywanie pod słońcem przez ok godzinę poprawi zmarszczki.



**OSTRZEŻENIE**

TRZYMAĆ WSZYSTKIE ŹRÓDŁA PŁOMIENIA I CIEPŁA

Z dala od tej tkaniny kopułowej

**Manufacturer:**Shanghaimuxinmuyeyouxiangongsi

**Address:** Shuangchenglu 803nong11hao1602A-1609shi, baoshanqu, shanghai 200000 CN.

**Imported to AUS:** SIHAO PTY LTD. 1 ROKEVA STREETEASTWOOD NSW 2122 Australia

**Imported to USA:** Sanven Technology Ltd. Suite 250, 9166 Anaheim Place, Rancho Cucamonga, CA 91730



E-CrossStu GmbH  
Mainzer Landstr.69, 60329 Frankfurt am Main.



YH CONSULTING LIMITED.  
C/O YH Consulting Limited Office 147, Centurion House,  
London Road, Staines-upon-Thames, Surrey, TW18 4AX



**VEVOR**<sup>®</sup>

**TOUGH TOOLS, HALF PRICE**

Technical Support and E-Warranty Certificate

[www.vevor.com/support](http://www.vevor.com/support)