



TX-R2764  
TX-R2765  
TX-R3264  
TX-R3065W  
TX-R3265

COLOR TELEVISION



# Owner's Instructions

Register your product at [www.samsung.com/global/register](http://www.samsung.com/global/register)

# Important Warranty Information Regarding Television Format Viewing

Standard screen format televisions (4:3, the aspect ratio of the screen width to height) are primarily designed to view standard format full-motion video. The images displayed on them should primarily be in the standard 4:3 ratio format and constantly moving. Displaying stationary graphics and images on screen, such as the dark top and bottom letterbox bars (wide screen pictures), should be limited to no more than 15% of the total television viewing per week.

Wide screen format televisions (16:9, the aspect ratio of the screen width to height) are primarily designed to view wide screen format full-motion video. The images displayed on them should primarily be in the wide screen 16:9 ratio format, or expanded to fill the screen if your model offers this feature, and constantly moving. Displaying stationary graphics and images on screen, such as the dark side-bars on non-expanded standard format television video and programming, should be limited to no more than 15% of the total television viewing per week.

Additionally, viewing other stationary images and text such as stock market reports, video game displays, station logos, web sites or computer graphics and patterns, should be limited as described above for all televisions. *Displaying any stationary images that exceed the above guidelines can cause uneven aging of picture tubes (CRTs) that leave subtle, but permanent burned-in ghost images in the television picture. To avoid this, vary the programming and images, and primarily display full screen moving images, not stationary patterns or dark bars.* On television models that offer picture sizing features, use these controls to view the different formats as a full screen picture.

Be careful in the selection and duration of television formats used for viewing. Uneven CRT aging as a result of format selection and use, as well as other burned-in images, is not covered by your Samsung limited warranty.

<b>Chapter 1: Your New TV</b> . . . . .	<b>5</b>
List of Features . . . . .	5
Accessories . . . . .	5
Familiarizing Yourself with The TV . . . . .	6
Control Buttons . . . . .	6
Connection Jacks (Side) . . . . .	7
Connection Jacks (Rear) . . . . .	8
Remote Control . . . . .	9
<b>Chapter 2: Installation</b> . . . . .	<b>11</b>
Connecting VHF and UHF Antennas . . . . .	11
Antennas with 300-ohm Flat Twin Leads . . . . .	11
Antennas with 75-ohm Round Leads . . . . .	12
Separate VHF and UHF Antennas . . . . .	12
Connecting Cable TV . . . . .	12
Cable without a Cable Box . . . . .	12
Connecting to a Cable Box that Descrambles All Channels . . . . .	13
Connecting to a Cable Box that Descrambles Some Channels . . . . .	13
Connecting a VCR . . . . .	15
Connecting a Second VCR to Record from the TV . . . . .	16
Connecting a DVD Player . . . . .	17
Connecting to Y, PB, PR . . . . .	17
Connecting to Regular Audio and Video Jacks . . . . .	17
Connecting a Digital TV Set-Top Box . . . . .	18
Connecting to Y, PB, PR . . . . .	18
Connecting a Camcorder . . . . .	19
Connecting to an Analog Amplifier . . . . .	20
Installing Batteries in the Remote Control . . . . .	21
<b>Chapter 3: Operation</b> . . . . .	<b>22</b>
Turning the TV On and Off . . . . .	22
Plug & Play Feature . . . . .	22
Viewing the Menus and On-Screen Displays . . . . .	24
Viewing the Menus . . . . .	24
Viewing the Display . . . . .	24
Selecting a Menu Language . . . . .	25
Memorizing the Channels . . . . .	26
Selecting the Video Signal-source . . . . .	26
Storing Channels in Memory (Automatic Method) . . . . .	27
Adding and Erasing Channels (Manual Method) . . . . .	28
Changing Channels . . . . .	29
Using the Channel Buttons . . . . .	29
Using the Number Buttons . . . . .	29
Using the PRE-CH Button to Select the Previous Channel . . . . .	29
Labeling the Channels . . . . .	30
Setting the Clock . . . . .	31
Option 1: Setting the Clock Manually . . . . .	31
Option 2: Setting the Clock Automatically . . . . .	32

**Chapter 3: Operation (Cont.) . . . . . 34**

Picture Control . . . . . 34  
     Using Automatic Picture Settings . . . . . 34  
     Customizing the Picture . . . . . 35  
 Sound Control . . . . . 35  
     Adjusting the Volume . . . . . 36  
     Using the Mute Button . . . . . 36  
     Using Automatic Sound Settings . . . . . 37  
     Customizing the Sound . . . . . 38  
 Viewing an External Signal Source . . . . . 39  
     Setting the Signal Source . . . . . 39  
     Assigning Names to External input mode . . . . . 40

**Chapter 4: Special Features . . . . . 41**

Fine Tuning Channels . . . . . 41  
 Changing the Color Tone . . . . . 42  
 Changing the Screen Size . . . . . 43  
 Digital Noise Reduction . . . . . 44  
 Tilt . . . . . 45  
 Using the R.Surf Feature . . . . . 46  
 Freezing the Picture . . . . . 46  
 Choosing a Multi-Channel Sound (MTS) track . . . . . 47  
 Auto Volume . . . . . 48  
 Setting the Surround . . . . . 49  
 Setting the Turbo Sound . . . . . 50  
 Setting the On/Off Timer . . . . . 51  
 Setting the Sleep Timer . . . . . 52  
 Setting the Preferred Volume Level and Channel . . . . . 53  
 Viewing Closed Captions . . . . . 54  
 Setting The On/Off Melody . . . . . 55  
 Using the V-Chip . . . . . 56  
     How to Change Your Password . . . . . 56  
     How to Enable/Disable the Rating Controls . . . . . 57  
     How to Set up Restrictions Using the “TV Parental Guidelines” . . . . . 58  
     How to Set up Restrictions using the Movie Ratings: G, PG, PG-13, R, NC-17, X . . . . . 59  
     Important Notes About Parental Locks . . . . . 60  
     How to Set up Restrictions Using the “Canadian English” . . . . . 61  
     How to Set up Restrictions Using the “Canadian French” . . . . . 62  
     How to Reset the TV after the V-Chip Blocks (“Emergency Escape”) . . . . . 63  
 Customizing Your Remote Control . . . . . 64

**Chapter 5: Troubleshooting . . . . . 66**

Identifying Problems . . . . . 66

**Appendix . . . . . 67**

Cleaning and Maintaining Your TV . . . . . 67  
 Using Your TV in Another Country . . . . . 67  
 Specifications . . . . . 67

# Chapter One

## YOUR NEW TV

### List of Features

Your TV is designed with the latest technology. This TV is a high-performance unit that includes the following special features:

- Full Flat Screen
- Automatic timer to turn the TV on and off
- Adjustable picture and sound settings that can be stored in the TV's memory
- Automatic channel tuning for up to 181 channels
- A special filter to reduce or eliminate reception problems
- A built-in multi-channel sound decoder for stereo and bilingual listening
- Built-in, dual channel speakers
- A special sleep timer
- V-Chip function

### Accessories

Once you have unpacked your TV, check to make sure that you have all the parts shown here. If any piece is missing or broken, call your dealer.

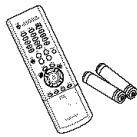

Remote Control(AA59-00322B)/  
AAA Batteries

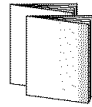

Owner's Instructions/  
Safety Guide Manual



Warranty Card/  
Registration Card

## Familiarizing Yourself with The TV

### Control Buttons

You can control your TV's basic features, including the on-screen menu. To use the more advanced features, you must use the remote control.

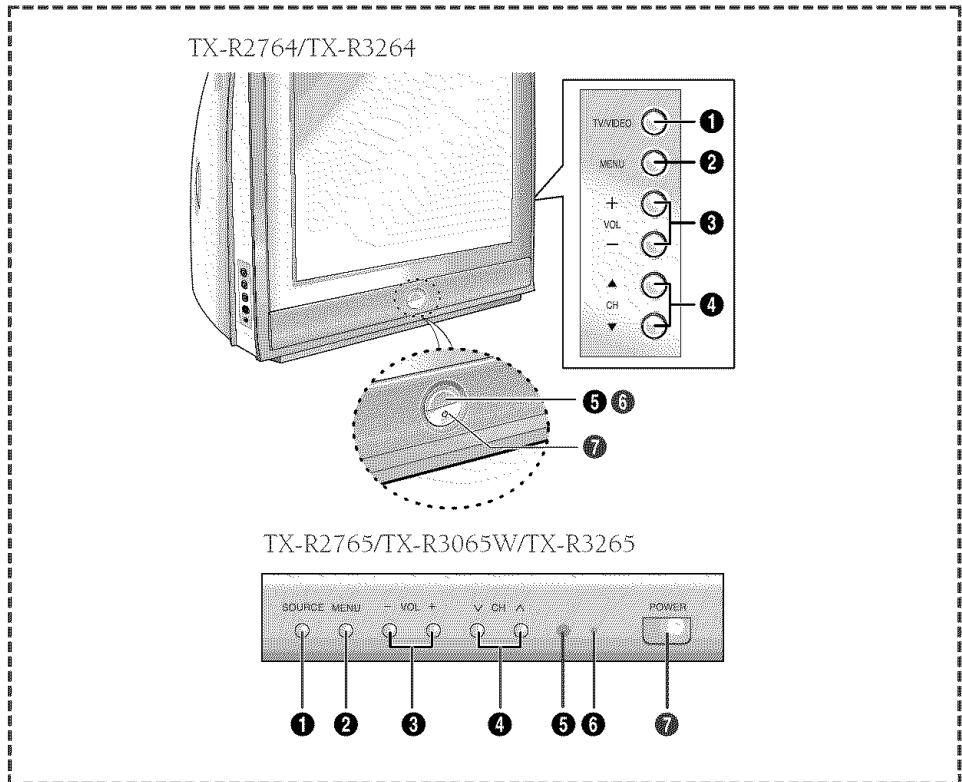

**1 TV/VIDEO (TX-R2676/TX-R3276) & SOURCE (TX-R2765/TX-R3065W/TX-R3265)**  
Press to change between viewing TV programs and signals from other components.

**2 MENU**  
Press to see an on-screen menu of your TV's features.

**3 - VOL +**  
Press to increase or decrease the volume. Also used to select items on the on-screen menu.

**4 ▲ CH ▼ (TX-R2676/TX-R3276) & ▼ CH ▲ (TX-R2765/TX-R3065W/TX-R3265)**  
Press to change channels. Also press to move between items on the on-screen menu.

**5 Remote Control Sensor**  
Aim the remote control towards this spot on the TV.

**6 TIMER indicator**  
When the TV is turned on, the TIMER indicator blinks five times. This indicator illuminates when the TIMER mode is set to the "On" position after setting the clock and either the On timer or Off timer, with the remote control. Even if the power is turned off, this indicator stays lit. (Clock must be set before using this function.)

**7 POWER**  
Press to turn the TV on and off.

### Connection Jacks (Side)

You can connect an A/V component that is used only occasionally, such as a camcorder or video game. (For information on connecting equipment, see page 19.)

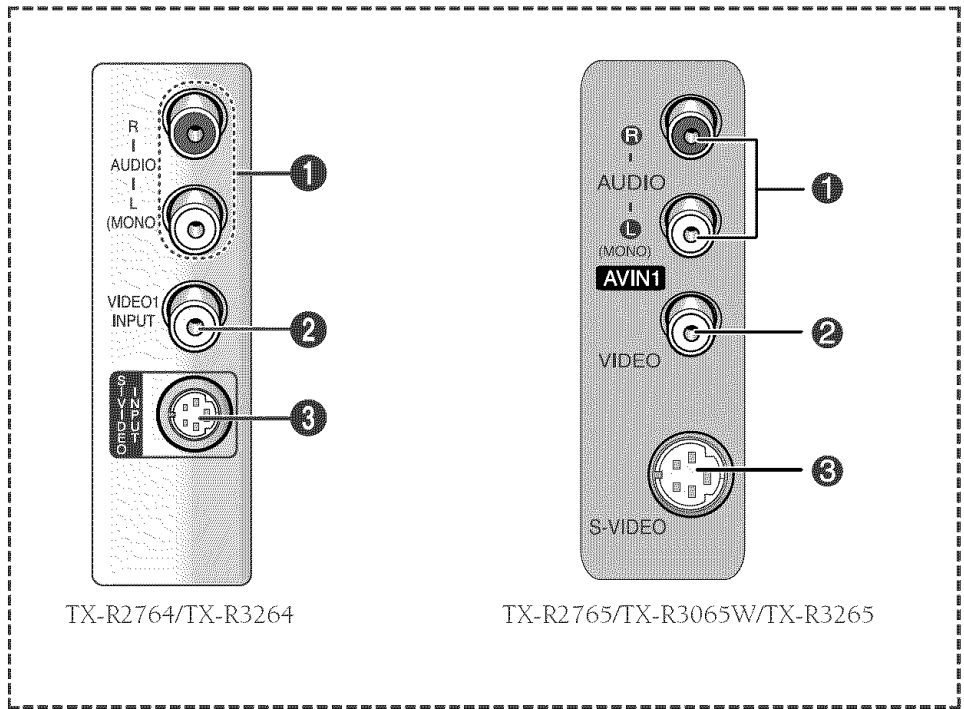

**❶ AUDIO Input**

Connect audio signals from a camcorder or video game.

**❷ VIDEO Input**

Connect a video signal from a camcorder or video game.

**❸ S-VIDEO Input**

Connect an S-Video signal from a camcorder or video game.

### Connection Jacks (Rear)

Use the rear panel jacks to connect an A/V component that will be connected continuously, such as a VCR or a DVD player.

For more information on connecting equipment, see pages 11~20.

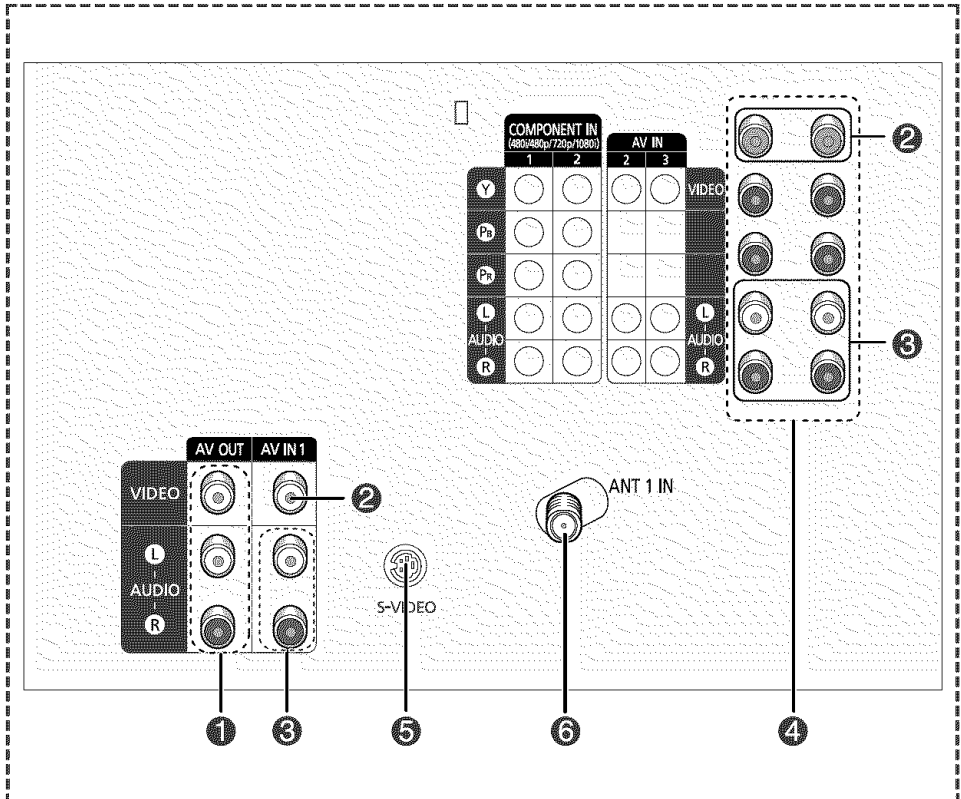

**1 Audio-Video Output jacks**

Connect to the audio/video input jacks of a recording VCR.

**2 Video Input jacks**

Connect to the video output jacks of VCRs, DVD players and similar devices.

**3 Audio Input jacks**

Connect to the audio output jacks of VCRs, DVD players and similar devices.

**4 Component Input jacks (Y, Pb, Pr, AUDIO-L/R)**

Connect to the Component audio and video outputs of DVD or DTV set-top box. 480i/480p/720p/1080i Y, Pb and Pr video signal inputs are available.

**5 S-Video Input jack**

Connect to S-Video output jack of an S-VHS VCR or DVD player.

**6 ANTENNA terminal**

Connect to an antenna or a cable TV system.

## Remote Control

You can use the remote control up to about 23 feet from the TV. When using the remote, always point it directly at the TV.

You can also use your remote control to operate your VCR, DVD and Cable box, and Samsung set-top box. See pages 65~65 for details.

### 1 POWER

Turns the TV on and off.

### 2 S.MODE

Adjust the TV sound by selecting one of the preset factory settings (or select your personal, customized sound settings).

### 3 P.MODE

Adjust the TV picture by selecting one of the preset factory settings (or select your personal, customized picture settings).

### 4 Number buttons

Press to select channels directly on the TV.

#### +100

Press to select channels over 100. For example, to select channel 121, press "+100," then press "2" and "1."

### 5 VOL +, VOL -

Press to increase or decrease the volume.

### 6 MUTE

Press to temporarily cut off the sound.

### 7 SLEEP

Press to select a preset time interval for automatic shut off.

### 8 MENU

Displays the main on-screen menu.

### 9 P.SIZE

Press to change the screen size.

### 10 R.SURF

Press to automatically return to a preferred channel after a user-preset time delay.

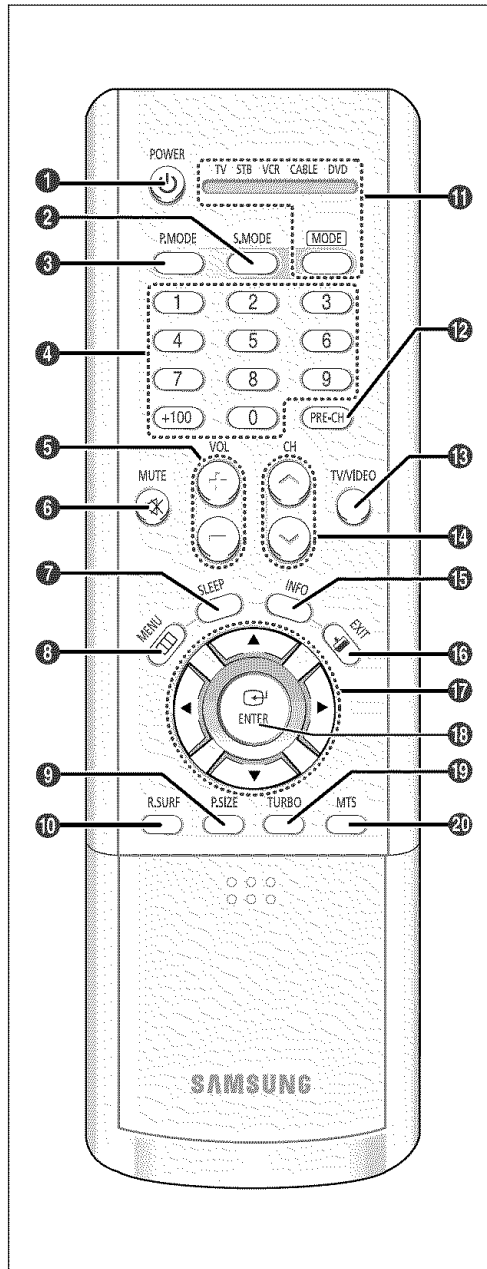

### 11 MODE

Selects a target device to be controlled by this remote control (i.e., TV, Samsung STB, VCR, Cable box, or DVD).

### 12 PRE-CH

Tunes to the previous channel.

### 13 TV/VIDEO

Press to display all of the available video sources.

### 14 CH ^, CH v

Press to change channels.

### 15 INFO

Press to display information on the TV screen.

### 16 EXIT

Press to exit the menu.

### 17 ▲/▼/◀/▶

Controls the cursor in the menu.

### 18 ENTER

While using the on-screen menus, press ENTER to activate (or change) a particular item.

### 19 TURBO

Press to turn the TURBO sound On or Off.

### 20 MTS (Multi-channel Television Sound)

Press to choose "Stereo", "Mono", or "SAP" (Secondary Audio Program).

**Remote Control**

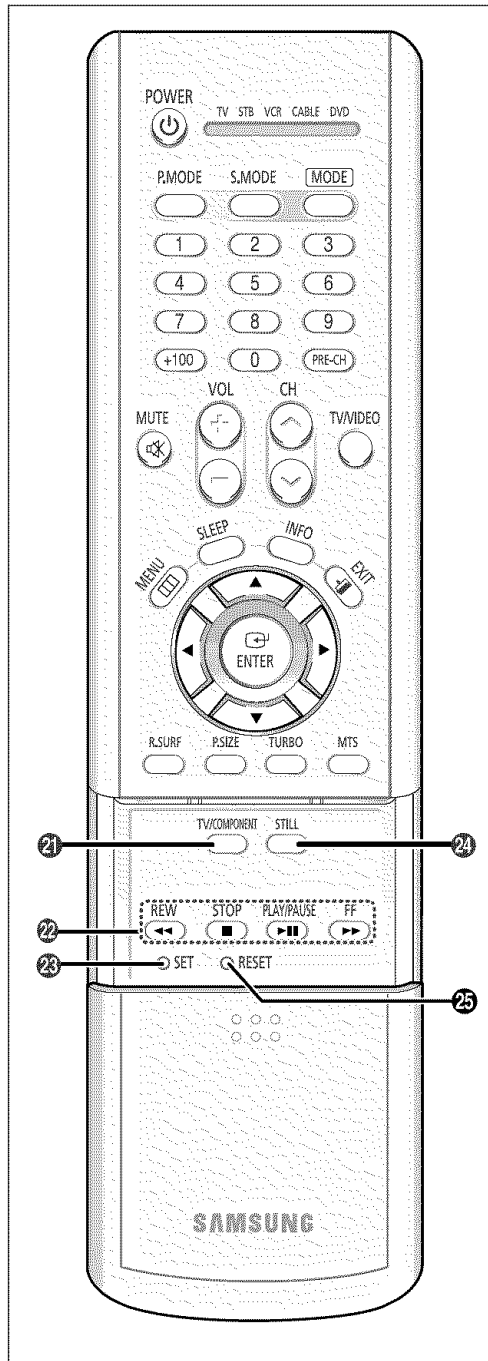

**21 TV/COMPONENT**

Press to switch the TV, COMPONENT1 or 2 mode.

**22 VCR/DVD Controls**

Controls VCR/DVD functions: Rewind, Stop, Play/Pause, Fast Forward.

**23 SET**

Used during set up of this remote control, so that it will work compatibly with other devices (VCR, Samsung set-top box, Cable box, DVD, etc.)

**24 STILL**

Press to stop the action during a particular scene. Press again to resume normal video. Note: The still function doesn't operate in Component 1, 2 mode.

**25 RESET**

If your remote control is not functioning properly, take out the batteries and press the reset button for about 2-3 seconds. Re-insert the batteries and try using the remote control again.

# Chapter Two

## INSTALLATION

### Connecting VHF and UHF Antennas

If your antenna has a set of leads that look like this, see “Antennas with 300-ohm Flat Twin Leads” below.

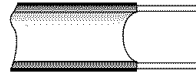

If your antenna has one lead that looks like this, see “Antennas with 75-ohm Round Leads” on page 12.



If you have two antennas, see “Separate VHF and UHF Antennas” on page 12.

#### Antennas with 300-ohm Flat Twin Leads

If you are using an off-air antenna (such as a roof antenna or “rabbit ears”) that has 300-ohm twin flat leads, follow the directions below.

**1**

Place the wires from the twin leads under the screws on the 300-75 ohm adaptor (not supplied). Use a screwdriver to tighten the screws.

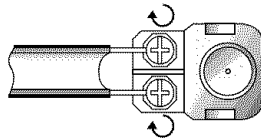

**2**

Plug the adaptor into the “ANT 1 IN” terminal on the rear panel.

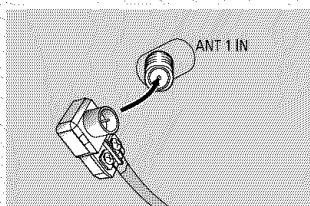

## INSTALLATION

### Antennas with 75-ohm Round Leads

- 1 Plug the antenna lead into the "ANT 1 IN" terminal on the rear panel.

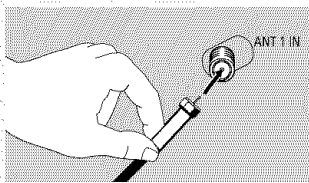

### Separate VHF and UHF Antennas

If you have two separate antennas for your TV (one VHF and one UHF), you must combine the two antenna signals before connecting the antennas to the TV. This procedure requires an optional combiner-adaptor (available at most electronics shops).

- 1 Connect both antenna leads to the combiner.

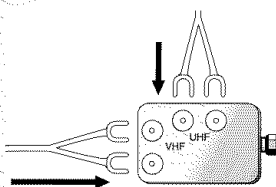

- 2 Plug the combiner into the "ANT 1 IN" terminal on the rear panel.

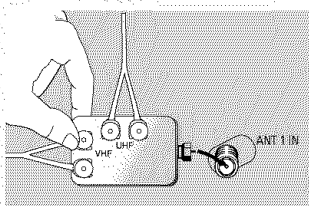

### Connecting Cable TV

To connect to a cable TV system, follow the instructions below.

#### Cable without a Cable Box

- 1 Plug the incoming cable into the "ANT 1 IN" terminal on the rear panel.

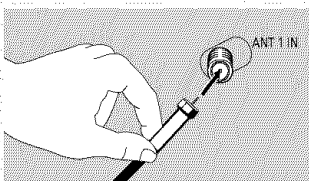

### Connecting to a Cable Box that Descrambles All Channels

**1**  
Find the cable that is connected to the ANTENNA OUT terminal on your cable box.

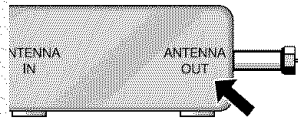

◀ This terminal might be labeled "ANT OUT", "VHF OUT" or simply, "OUT".

**2**  
Connect the other end of this cable to the "ANT 1 IN" terminal on the rear panel.

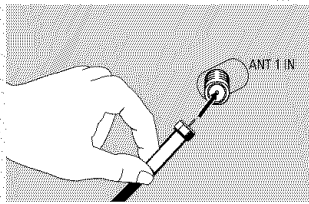

### Connecting to a Cable Box that Descrambles Some Channels

If your cable box descrambles only some channels (such as premium channels), follow the instructions below. You will need a two-way splitter, an RF (A/B) switch, and four lengths of coaxial cable. (These items are available at most electronics stores.)

**1**  
Find and disconnect the cable that is connected to the ANTENNA IN terminal on your cable box.

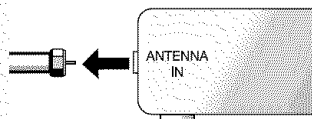

◀ This terminal might be labeled "ANT IN", "VHF IN" or simply, "IN".

**2**  
Connect this cable to a two-way splitter.

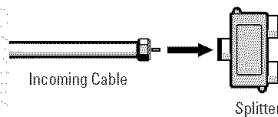

**3**  
Connect a coaxial cable between an OUTPUT terminal on the splitter and the IN terminal on the cable box.

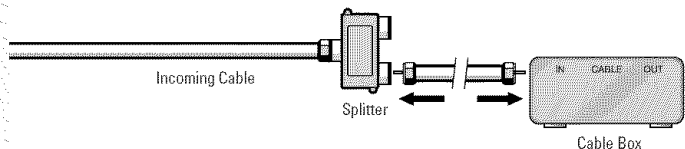

*continued...*

## INSTALLATION

**4**

Connect a coaxial cable between the ANTENNA OUT terminal on the cable box and the B-IN terminal on the RF (A/B) switch.

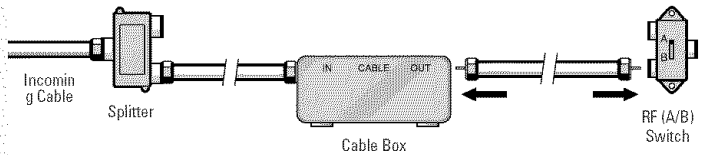

**5**

Connect another cable between the other OUT terminal on the splitter and the A-IN terminal on the RF (A/B) switch.

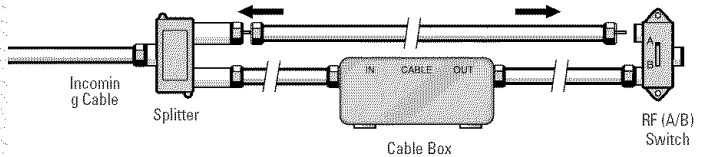

**6**

Connect the last coaxial cable between the OUT terminal on the RF (A/B) switch and the "ANT 1 IN" terminal on the rear panel.

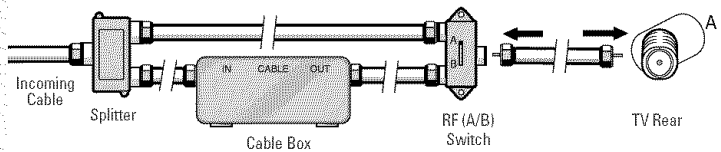

After you've made this connection, set the A/B switch to the "A" position for normal viewing. Set the A/B switch to the "B" position to view scrambled channels. (When you set the A/B switch to "B", you will need to tune your TV to the cable box's output channel, which is usually channel 3 or 4.)

## Connecting a VCR

These instructions assume that you have already connected your TV to an antenna or a cable TV system (according to the instructions on pages 11~14).

**1**

Connect a coaxial cable between the "ANT 1 IN" terminal on the TV and the antenna out terminal on the VCR. A coaxial cable is usually included with a VCR. (If not, check your local electronics store).

**2**

Connect a set of audio cables between the "AV IN 1 (L, R)" (or "AV IN 2/3 (L, R)") jacks on the TV and AUDIO OUT jacks on the VCR.

If you have a mono VCR, connect L(mono) to VCR audio out using only one audio cable.

**3**

Connect a video cable between the "AV IN 1 (VIDEO)" (or "AV IN 2/3 (VIDEO)") jack on the TV and the VIDEO OUT jack on the VCR.

Refer to your VCR's instructions for more information about how to view your VCR tape.

TV Rear Panel

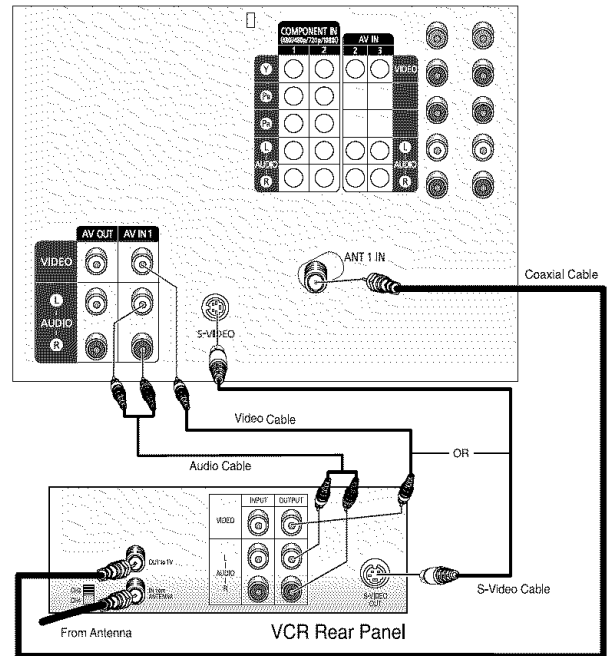

- Also, you can connect to "AV IN 1" on the side panel of TV.

## Connecting a Second VCR to Record from the TV

Your TV can send out signals of its picture and sound to be recorded by a second VCR. To do this, connect your second VCR as follows:

**1**

Connect a set of audio cables between the **AUDIO OUT** jacks on the TV and the **AUDIO IN** jacks on the VCR. (The VCR input jacks might be either on the front or on back of the VCR.)

**2**

Connect a video cable between the **VIDEO OUT** jack on the TV and the **VIDEO IN** jack on the VCR.

Refer to your VCR's instructions for more information about how to record using this kind of connection.

Refer to your VCR's instructions for more information about how to record using this kind of connection.

TV Rear Panel

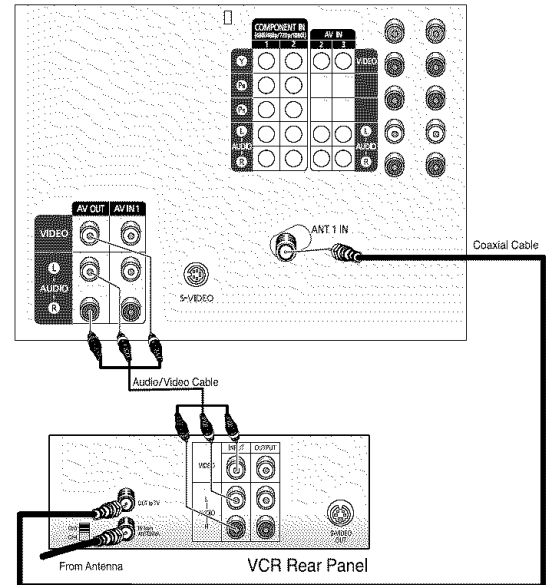

## Connecting a DVD Player

The rear panel jacks on your TV make it easy to connect a DVD player to your TV.

### Connecting to Y, Pb, Pr

**1** Connect a set of audio cables between the "COMPONENT IN 1 (L, R)" (or "COMPONENT IN 2 (L, R)") jacks on the TV and the AUDIO OUT jacks on the DVD player.

**2** Connect a set of video cables between the "COMPONENT IN 1 (Y, Pb, Pr)" (or "COMPONENT IN 2 (Y, Pb, Pr)") jacks on the TV and the VIDEO OUT (Y, Pb, Pr) jacks on the DVD player.

For an explanation of Component video, see your DVD player's owner's instruction.

TV Rear Panel

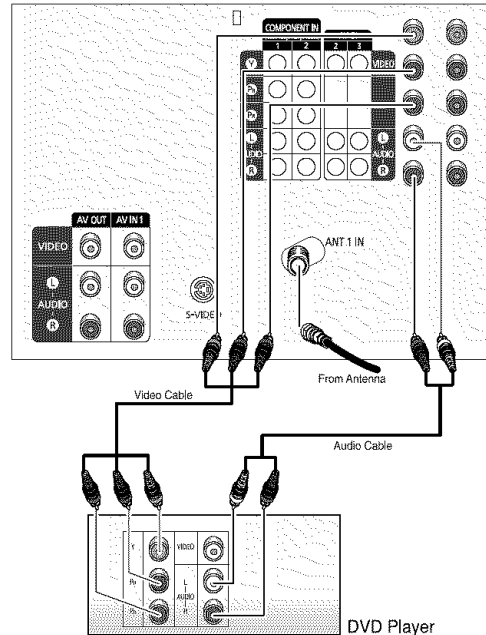

### Connecting to Regular Audio and Video Jacks

**1** Connect a set of audio cables between the "AV IN 1 (L, R)" (or "AV IN 2/3 (L, R)") jacks on the TV and the AUDIO OUT jacks on the DVD player.

**2** Connect a video cable between the "AV IN 1 (VIDEO)" (or "AV IN 2/3 (VIDEO)") jack on the TV and the VIDEO OUT jack on the DVD player.

TV Rear Panel

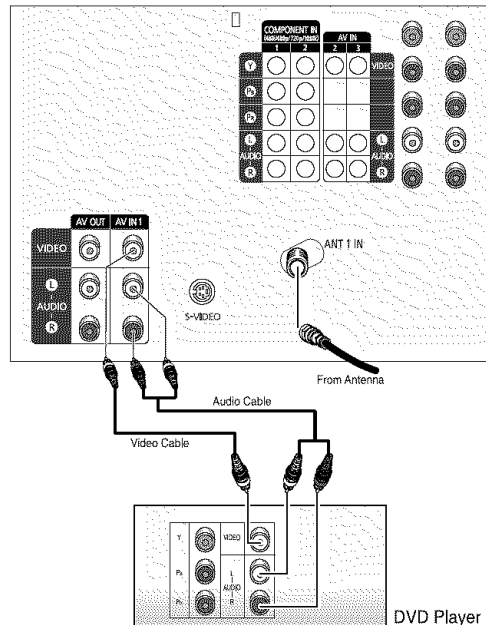

- Also, you can connect to "AV IN 1" on the side panel of TV.

## Connecting a Digital TV Set-Top Box

The rear panel jacks on your TV make it easy to connect a set-top box to your TV.

### Connecting to Y, Pb, Pr

**1** Connect a coaxial cable to the ANTENNA IN terminal on the set-top box.

**2** Connect a set of audio cables between the "COMPONENT IN 1 (L, R)" (or "COMPONENT IN 2 (L, R)") jacks on the TV and the AUDIO OUT jacks on the set-top box.

**3** Connect a set of video cables between the "COMPONENT IN 1 (Y, Pb, Pr)" (or "COMPONENT IN 2 (Y, Pb, Pr)") jacks on the TV and the VIDEO OUT (Y, Pb, Pr) jacks on the set-top box.

The connections for a typical set-top box are shown. For detailed information, refer to the set-top box instruction manual.

TV Rear Panel

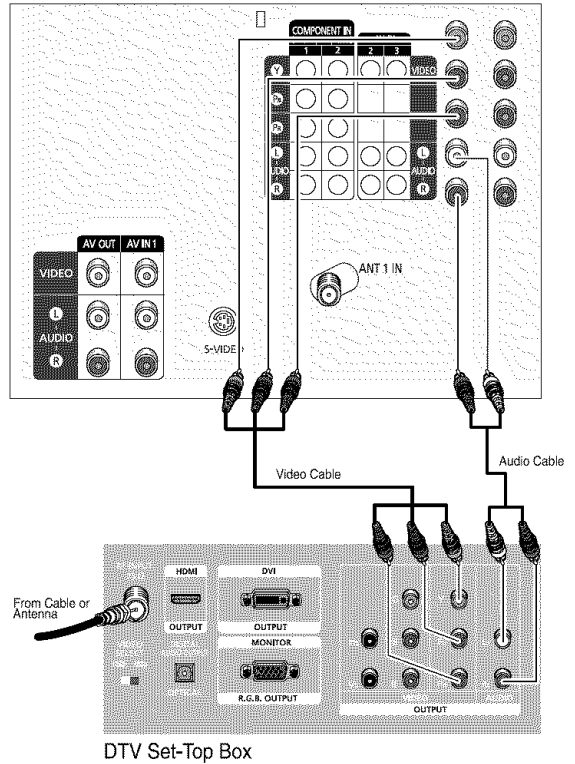

## Connecting a Camcorder

The side panel jacks on your TV make it easy to connect a Camcorder to your TV. They allow you to view the Camcorder tapes without using a VCR.

**1** Locate the A/V output jacks on the Camcorder. They are usually found on the side or rear of the Camcorder.

**2** Connect a set of audio cables between the "AV IN 4 (L, R)" jacks on the TV and the AUDIO OUT jacks on the Camcorder.

If you have mono Camcorder, connect L(mono) to Camcorder audio out using only one audio cable.

**3** Connect a video cable between the "AV IN 4 (VIDEO)" (or "S-VIDEO IN 2") jack on the TV and the VIDEO OUT jacks on the Camcorder.

The audio-video cables shown here are usually included with a Camcorder. (If not, check your local electronics store.) If your Camcorder is stereo, you need to connect a set of two cables.

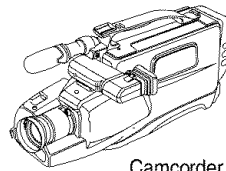
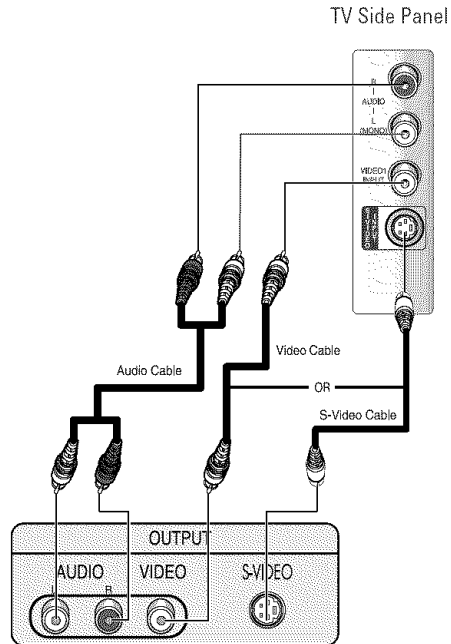

Camcorder

## Connecting to an Analog Amplifier

The "AUDIO OUT" terminals cannot be used for external speakers. You must hook them up to an amplifier.

When an audio amplifier is connected to the "AUDIO OUT" terminals:  
 Decrease the gain (volume) of the audio amplifier, and adjust the volume level with the volume control on the TV.

TV Rear Panel

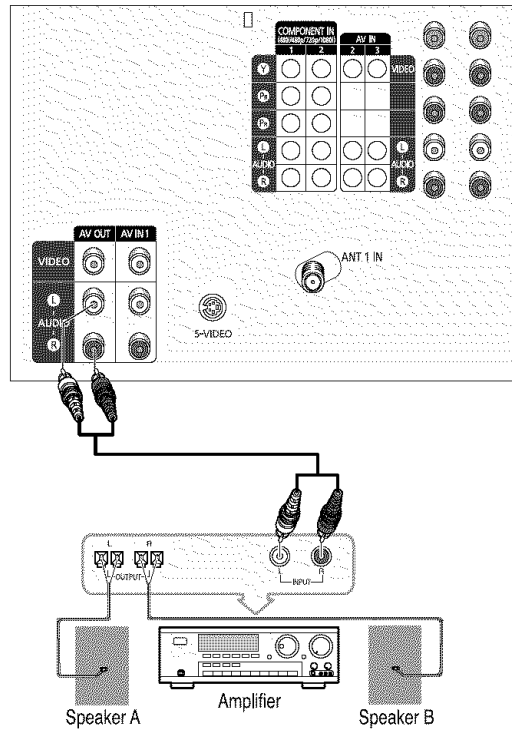

## Installing Batteries in the Remote Control

- 1**  
Slide the cover out completely.

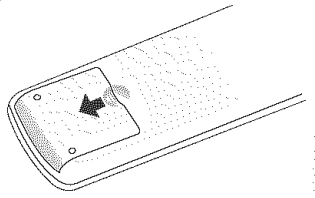

- 2**  
Install two AAA size batteries.

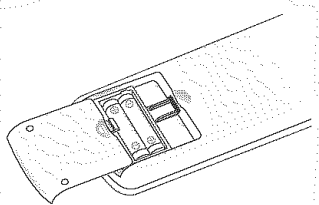

- ◀ Make sure to match the “+” and “-” ends of the batteries with the diagram inside the compartment.

- 3**  
Replace the cover.

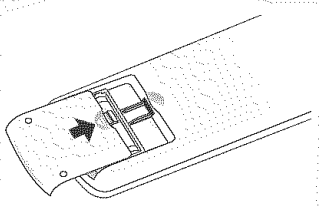

- ◀ Remove the batteries and store them in a cool, dry place if you won't be using the remote control for a long time.

The remote control can be used up to about 23 feet from the TV. (Assuming typical TV usage, the batteries last for about one year.)

# Chapter Three

## OPERATION

### Turning the TV On and Off

Press the **POWER** button on the remote control.

You can also use the **POWER** button on the front panel.

### Plug & Play Feature

When the TV is initially powered On, basic customer settings proceed automatically and subsequently: Setting the language, Antenna input check, Channel Memorize and Time Setting.

Note : The Plug & Play function operates after plugging in the TV for the first time.

**1**  
Press the **POWER** button on the remote control.

The message "Plug & Play" is displayed. It flickers for a little while and then the "Language" menu is displayed.

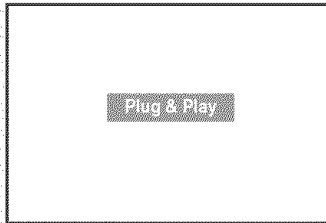

**2**  
Press the ◀ or ▶ button to select the desired language. Press the **MENU** button to enter the language, then the "Channel" menu is displayed.

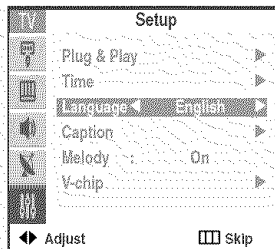

**3**  
Press the ◀ or ▶ button to select the desired video signal source. Press the **MENU** button to enter the video signal source, then the "Check antenna input." is displayed.

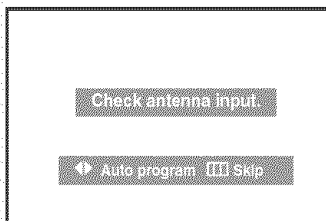
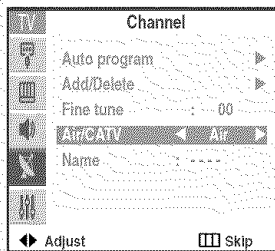

◀ STD, HRC, and IRC identify various types of cable TV systems. Contact your local cable company to identify the type of cable system that exists in your particular area.

**4**

Make sure that the antenna is connected to the TV. And then press the ◀ or ▶ button to activate "Auto Program" or press the **MENU** button to skip. (refer to "Auto program" on page 27.)

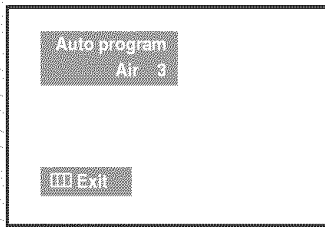

**5**

Press the ▶ button to move to the hour or minute. Set the hour or minute by pressing the ▲ or ▼ button. (refer to "Setting the Clock" on page 31.)

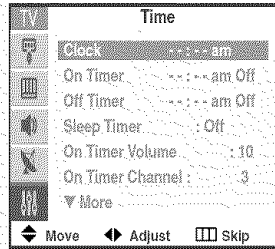

**6**

When you have finished, press the **MENU** button. The message "Enjoy your watching.." is displayed.



**7**

**If you want to reset this feature**  
 (1) Press the **MENU** button.  
 (2) Press the ▲ or ▼ button to select "Setup", then press the **ENTER** button.  
 (3) Press the **ENTER** button to select "Plug & Play".  
 The message "Plug & Play" is displayed.

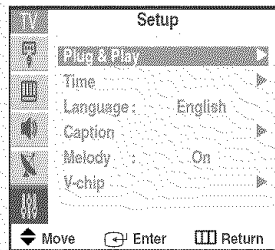

Note: Plug & Play feature doesn't work when the V-Chip is On or when in the AV mode.

## Viewing the Menu and On-Screen Displays

### Viewing the Menu

**1**

With the power on, press the **MENU** button.

The main menu appears on the screen. Its left side has five icons: Input, Picture, Sound, Channel and Setup.

Press the ◀ or ▶ button to select one of six icons. Then press the **ENTER** button to access the icon's sub-menu.

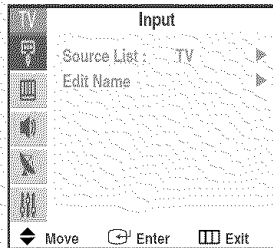

**2**

Press the ▲ or ▼ button to move to items in the menu (The icon is selected).

Press the **ENTER** or ▶ button to enter items in the menu. Press the ▲/▼/◀/▶ button to change the selected items. Press the **MENU** or ◀ button to return to the previous menu.

**3**

Press the **EXIT** button to exit.

◀ You can also use the **MENU**, **CH**, **VOL+/-**, and **ENTER** (◻) buttons on the control panel of the TV to make selections.

### Viewing the Display

The display identifies the current channel and the status of certain audio-video settings.

Press the **INFO** button on the remote control.

The TV displays the current channel, the channel label, signal, MTS and the current time.

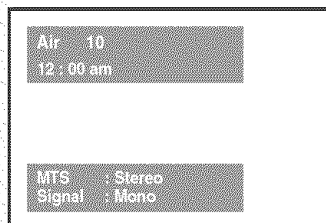

## Selecting a Menu Language

**1**

Press the **MENU** button.

Press the **▲** or **▼** button to select "Setup", then press the **ENTER** button.

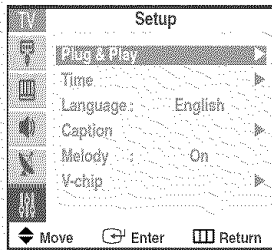

**2**

Press the **▲** or **▼** button to select "Language".

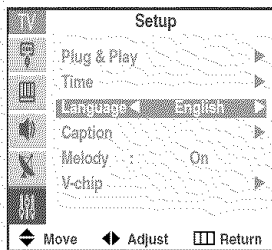

**3**

Press the **◀** or **▶** button to select "English", "Español" or "Français".

Press the **EXIT** button to exit.

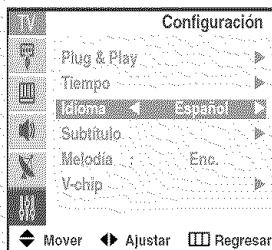

## Memorizing the Channels

Your TV can memorize and store all of the available channels for both “off-air” (antenna) and cable channels. After the available channels are memorized, use the **CH**  $\wedge$  and **CH**  $\vee$  buttons to scan through the channels. This eliminates the need to change channels by entering the channel digits. There are three steps for memorizing channels: selecting a broadcast source, memorizing the channels (automatic) and adding and deleting channels (manual).

### Selecting the Video Signal-source

Before your television can begin memorizing the available channels, you must specify the type of signal source that is connected to the TV (i.e., an antenna or a cable system).

**1**

Press the **MENU** button.

Press the  $\blacktriangle$  or  $\blacktriangledown$  button to select “Channel”, then press the **ENTER** button.

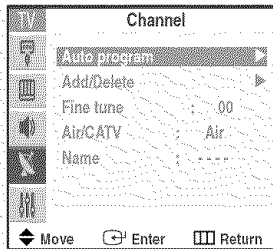

**2**

Press the  $\blacktriangle$  or  $\blacktriangledown$  button to select “Air/CATV”.

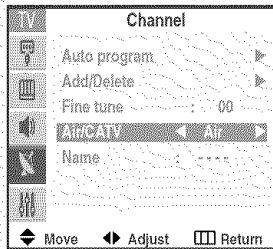

**3**

Press the  $\blacktriangleleft$  or  $\blacktriangleright$  button to select “Air” (antenna), “STD”, “HRC”, or “IRC” (all cable TV).

Press the **EXIT** button to exit.

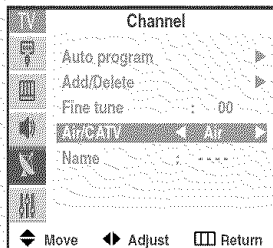

◀ Note: STD, HRC and IRC identify various types of cable TV systems. Contact your local cable company to identify the type of cable system that exists in your particular area.

## Storing Channels in Memory (Automatic Method)

**1**  
First, select the correct signal source (Air, STD, HRC, or IRC). See steps 1~3 on previous page.

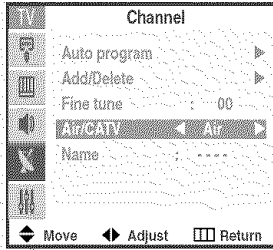

**2**  
Press the ▲ or ▼ button to select "Auto Program".

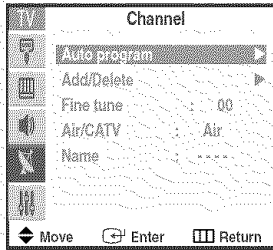

**3**  
Press the **ENTER** button. The TV begin memorizing all available channels.

After all the available channels are stored, the channel menu reappears.

Press the **EXIT** button to exit.

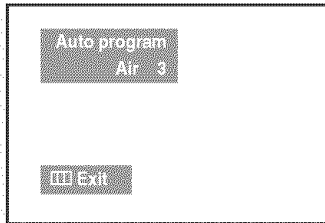

◀ The TV automatically cycles through all of the available channels and stores them in memory. This takes about one to two minutes.

Press the **MENU** button at any time to interrupt the memorization process and return to the Channel menu.

## Adding and Erasing Channels (Manual Method)

To add channels that were not memorized (or to delete unwanted channels from memory):

**1**

Press the **MENU** button.

Press the **▲** or **▼** button to select "Channel", then press the **ENTER** button.

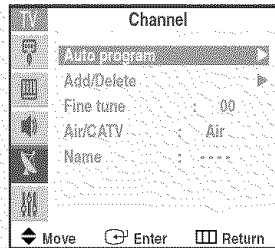

**2**

Press the **▲** or **▼** button to select "Add/Delete", then press the **ENTER** button.

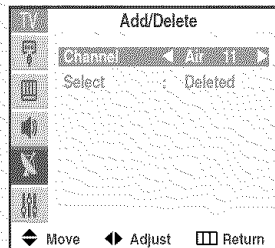

**3**

Press the **◀**, **▶**, or number button to select the channel you want to add or delete.

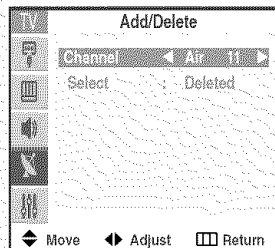

**4**

Press the **▲** or **▼** button to select "Select", then press the **◀** or **▶** button to select "Added" or "Deleted".

Press the **EXIT** button to exit.

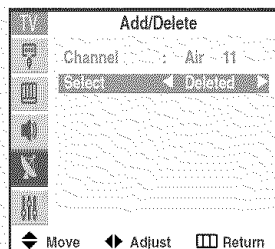

## Changing Channels

### Using the Channel Buttons

Press the **CH**  $\wedge$  or **CH**  $\vee$  button to change channels.

When you press **CH**  $\wedge$  or **CH**  $\vee$ , the TV changes channels in sequence. You will see all the channels that the TV has memorized. (The TV must have memorized at least three channels.) You will not see channels that were either erased or not memorized.

### Using the Number Buttons

Use the number buttons to quickly tune to any channel.

Press the number buttons to go directly to a channel.  
For example, to select channel 27, press "2" then "7".  
The TV will change channels when you press the second number.

When you use the number buttons, you can directly select channels that were either erased or not memorized.

To select a channel over 100, press the **+100** button. (For channel 122, press "+100" then "2" then "2".)

To change to single-digit channels (0–9) faster, press "0" before the single digit. (For channel "4" press "0" then "4".)

### Using the PRE-CH Button to Select the Previous Channel

Press the **PRE-CH** button.  
The TV changes to the last channel you were watching.

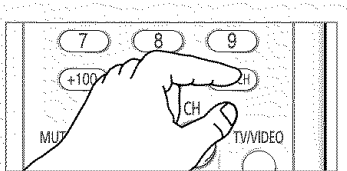

◀ To quickly switch between two channels that are far apart, tune to one channel, then use the number button to select the second channel. Then, use the **PRE-CH** button to quickly alternate between them.

## Labeling the Channels

Use this feature to assign an easy-to-remember label to any channel (i.e., “CBS”, “ESPN”, “PBS2”, “CNN1”, etc.) A label consists of four fields, where each field is a letter, a number, “\*”, or a blank. When the **INFO** button is pressed, the channel label will appear next to the channel number.

**1**

Press the **CH**  $\wedge$  or **CH**  $\vee$  button to tune to the channel that will be labeled.



**2**

Press the **MENU** button.

Press the  $\blacktriangle$  or  $\blacktriangledown$  button to select “Channel”, then press the **ENTER** button.

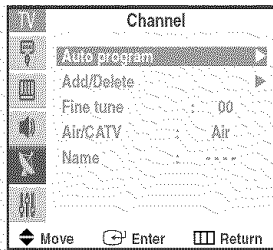

◀ Note: You cannot select “Name” in the AV mode.

**3**

Press the  $\blacktriangle$  or  $\blacktriangledown$  button to select “Name”, then press the  $\blacktriangleright$  button.

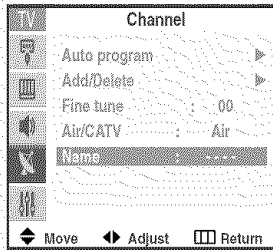

**4**

Press the  $\blacktriangle$  or  $\blacktriangledown$  button to select a letter, a number or a blank. (Results in this sequence: A...Z, \*, blank, 0...9.)

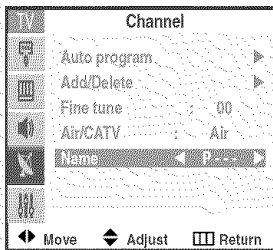

**5**

Press the  $\blacktriangleright$  button to switch to the next field, which will be selected.

Select a second letter or digit by pressing the  $\blacktriangle$  or  $\blacktriangledown$  button, as above.

Repeat the process to select the last two digits.

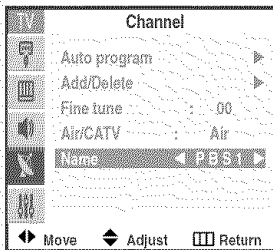

Press the **EXIT** button to exit.

## Setting the Clock

Setting the clock is necessary in order to use the various timer features of the TV. Also, you can check the time while watching the TV. (Just press the **INFO** button.)

### Option 1: Setting the Clock Manually

**1**

Press the **MENU** button.

Press the **▲** or **▼** button to select "Setup", then press the **ENTER** button.

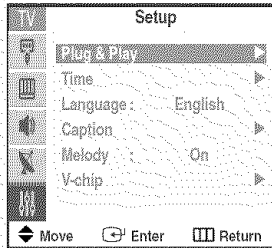

**2**

Press the **▲** or **▼** button to select "Time", then press the **ENTER** button.

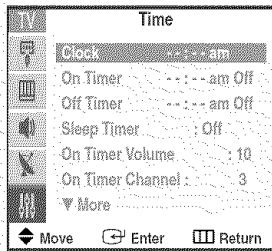

**3**

Press the **◀** or **▶** button to move to the hour or minute. Set the clock you want by pressing the **▲** or **▼** button, then press the **▶** button.

Press the **EXIT** button to exit.

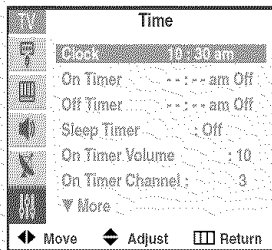

◀ When selecting the hours, be sure to select the proper time of day (am or pm).

You can set the hour and minute directly by pressing the number buttons on the remote control.

The current time will appear every time you press the **INFO** button.

## Option 2: Setting the Clock Automatically

The clock can be set automatically if you are receiving a digital signal.

**1**  
Press the **MENU** button.

Press the **▲** or **▼** button to select "Setup", then press the **ENTER** button.

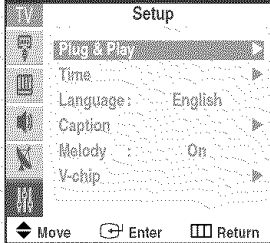

**2**  
Press the **▲** or **▼** button to select "Time", then press the **ENTER** button.

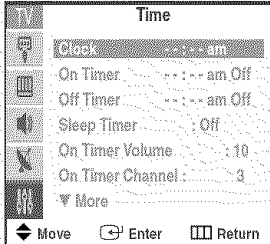

**3**  
Press the **▲** or **▼** button to select "Auto Clock Set", then press the **ENTER** button.

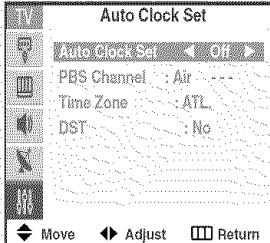

**4**  
Press the **◀** or **▶** button to select "On".

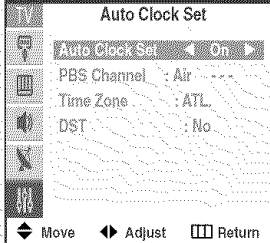

◀ Certain broadcasts may not transmit the correct time. In this case, set the time manually.

**5**  
Press the ▲ or ▼ button to select "PBS Channel", then press the ◀ or ▶ button to select your local PBS channel.

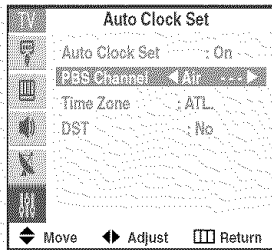

**6**  
Press the ▲ or ▼ button to select "Time Zone", then press the ◀ or ▶ button to select the time zone for your local area.

- ATL : Atlantic
- EAST : Eastern
- CEN : Central
- MTN : Mountain
- PAC : Pacific
- ALAS : Alaska
- HAW : Hawaii

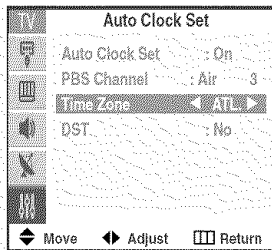

◀ The set time can be changed according to the broadcasting station and signal when you set up auto time. If there is a difference between the real time and set time, please set up manual time.

**7**  
Press the ▲ or ▼ button to select "DST" (Daylight Saving Time), then press the ◀ or ▶ button to select "Yes" or "No".

Press the EXIT button to exit.

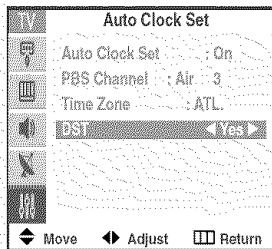

## Picture Control

You can select the type of picture which best corresponds to your viewing requirements.

### Using Automatic Picture Settings

Your TV has automatic picture settings (“Dynamic”, “Standard”, and “Movie”) that are preset at the factory. You can activate either Dynamic, Standard, Movie or Custom by pressing the **P.MODE** button (or by making a selection from the menu). Or, you can select “Custom” which automatically recalls your personalized picture settings.

**1**

Press the **MENU** button.

Press the **▲** or **▼** button to select “Picture”, then press the **ENTER** button.

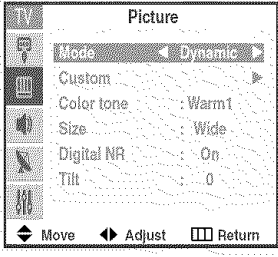

**2**

Press the **◀** or **▶** button to select a particular item.

Press the **EXIT** button to exit.

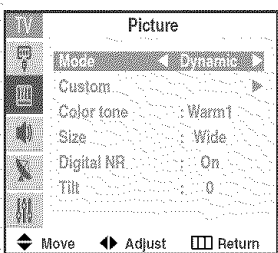

- Choose “Dynamic” for viewing the TV during the day or when there is bright light in the room.
- Choose “Standard” for the standard factory settings.
- Choose “Movie” when viewing the movie.
- Choose “Custom” if you want to adjust the settings according to personal preference.

## Customizing the Picture

You can use the on-screen menus to change the “Contrast”, “Brightness”, “Sharpness”, “Color”, and “Tint” according to personal preference.

**1**

Press the **MENU** button.

Press the **▲** or **▼** button to select “Picture”, then press the **ENTER** button.

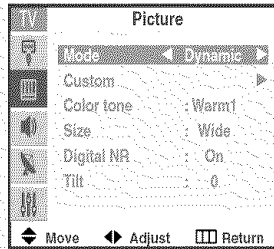

**2**

Press the **▲** or **▼** button to select “Custom”, then press the **ENTER** button.

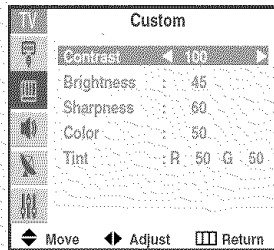

**3**

Press the **▲** or **▼** button to select a particular item (“Contrast”, “Brightness”, “Sharpness”, “Color”, or “Tint”).

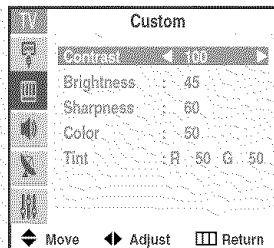

**4**

Press the **◀** or **▶** button to increase or decrease the value of a particular item.

Press the **▲** or **▼** button to select other items.

Press the **EXIT** button to exit.

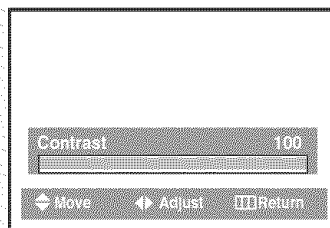

## Sound Control

### Adjusting the Volume

Press the **VOL +** or **VOL -** button to increase or decrease the volume.

### Using the MUTE Button

At any time, you can temporarily cut off the sound using the **MUTE** button.

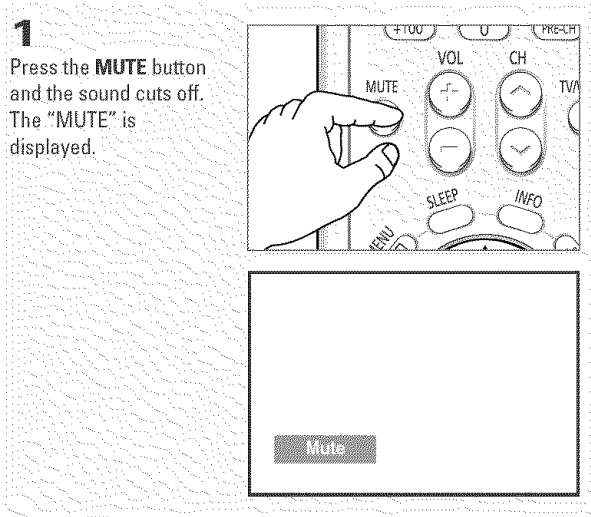

**2**  
To turn MUTE off, press the **MUTE** button again, or press either the **VOL +** or **VOL -** button.

## Using Automatic Sound Settings

Your TV has automatic sound settings (“Standard”, “Music”, “Movie” and “Speech”) that are preset at the factory. You can activate either Standard, Music, Movie or Speech by pressing the **S.MODE** button (or by making a selection from the menu). Or, you can select “Custom”, which automatically recalls your personalized sound settings.

**1**

Press the **MENU** button.

Press the **▲** or **▼** button to select “Sound”, then press the **ENTER** button.

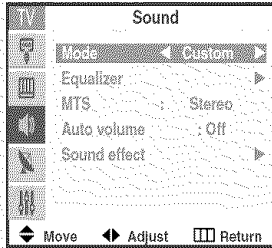

**2**

Press the **◀** or **▶** button to select a particular item.

Press the **EXIT** button to exit.

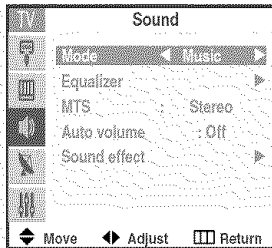

- Choose “Standard” for the standard factory settings.
- Choose “Music” when watching music videos or concerts.
- Choose “Movie” when watching movie.
- Choose “Speech” when watching a show that is mostly dialogue (i.e., news).
- Choose “Custom” to recall your personalized settings.

## Customizing the Sound

The sound settings can be adjusted to suit your personal preferences.

**1**

Press the **MENU** button.

Press the **▲** or **▼** button to select "Sound", then press the **ENTER** button.

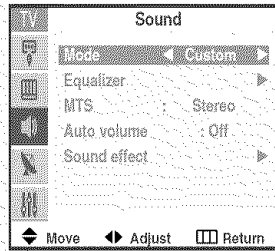

**2**

Press the **▲** or **▼** button to select "Equalizer", then press the **ENTER** button.

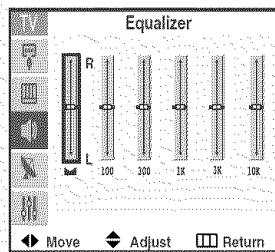

**3**

Press the **◀** or **▶** button to select a particular item.

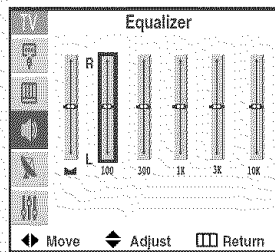

**4**

Press the **▲** or **▼** button to increase or decrease the value of a particular item.

Press the **EXIT** button to exit.

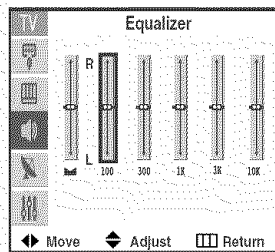

## Viewing an External Signal Source

Use the remote control to switch between viewing signals from connected equipment, such as a VCR, DVD, Set-Top Box and the TV source (broadcast or cable).

### Setting the Signal Source

**1**

Press the **MENU** button.  
Press the **ENTER** button to select "Input".

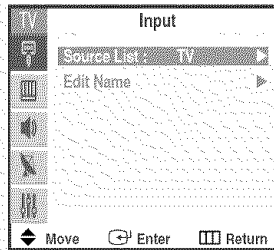

**2**

Press the **ENTER** button again.  
Press the **▲** or **▼** button to select the signal source, then press the **ENTER** button.

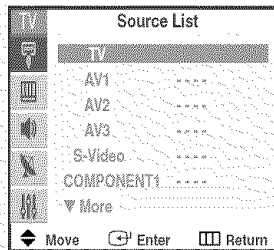

#### Alternate method:

Press the **TV/VIDEO** or **TV/COMPONENT** button on the remote control to select an external signal source.

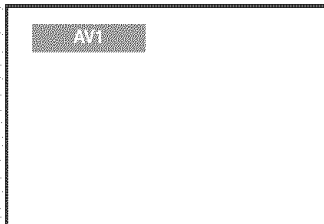

## Assigning Names to External Input Mode

- 1**  
Press the **MENU** button.  
Press the **ENTER** button to  
select "Input".

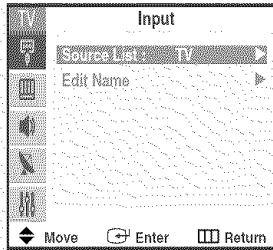

- 2**  
Press the **▲** or **▼** button to  
select "Edit Name", then press  
the **ENTER** button.

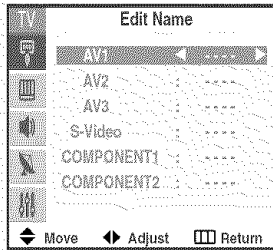

- 3**  
Press the **▲** or **▼** button to  
select the signal source to be  
edited.

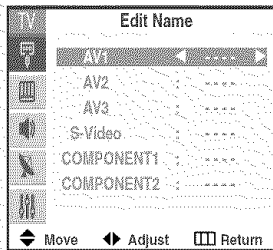

- 4**  
Press the **◀** or **▶** button to  
select the external device (VCR,  
DVD, Cable STB, Sat. STB, AV  
Recv., DVD Recv., Game,  
Camcorder, DVD Combo).

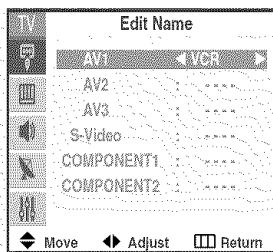

Set other signal sources (AV2,  
AV3, S-Video, COMPONENT1,  
COMPONENT2) using the same  
method as listed above.

Press the **EXIT** button to exit.

# Chapter Four

## SPECIAL FEATURES

### Fine Tuning Channels

The Fine Tuning function let you manually adjust the TV's tuner if you have difficulty tuning channels.

**1**

Press the **MENU** button.

Press the **▲** or **▼** button to select "Channel", then press the **ENTER** button.

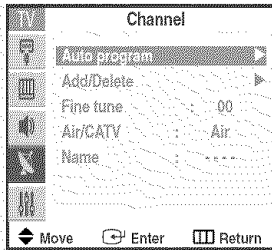

**2**

Press the **▲** or **▼** button to select "Fine tune".

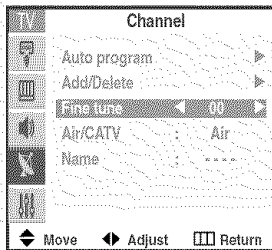

**3**

Press the **◀** or **▶** button to adjust the fine tuning.

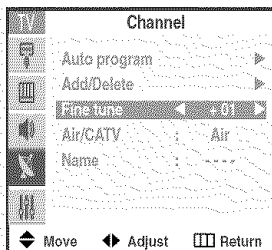

**4**

To store the fine tuning setting in the TV's memory, press the **▲** button. (The "\*" is displayed.)

To reset the fine tuning to "00", press the **▼** button.

Press the **EXIT** button to exit.

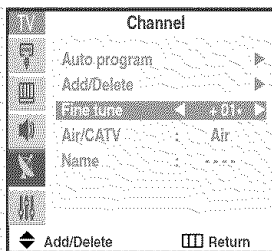

◀ After you adjust the fine tuning, the "\*" will appear when you press the **INFO** button while watching this channel.

## Changing the Color Tone

**1**

Press the **MENU** button.

Press the **▲** or **▼** button to select "Picture", then press the **ENTER** button.

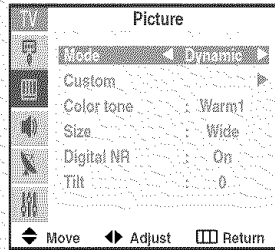

**2**

Press the **▲** or **▼** button to select "Color tone".

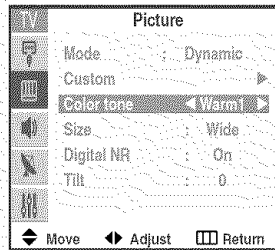

**3**

Press the **◀** or **▶** button to select a particular item ("Cool2", "Cool1", "Normal", "Warm1", or "Warm2").

Press the **EXIT** button to exit.

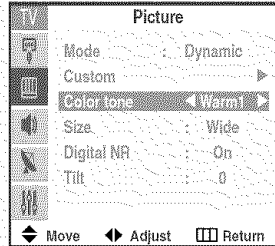

## Changing the Screen Size

**1**

Press the **MENU** button.

Press the **▲** or **▼** button to select "Picture", then press the **ENTER** button.

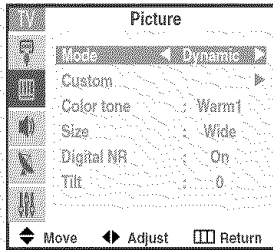

**2**

Press the **▲** or **▼** button to select "Size".

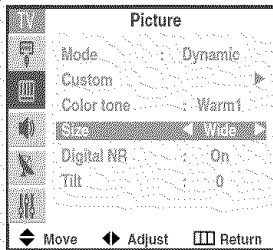

**3**

Press the **◀** or **▶** button to select the screen format you want.

Press the **EXIT** button to exit.

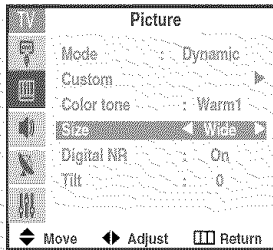

### Alternate method:

Press the **P.SIZE** button on the remote control to screen format you want.

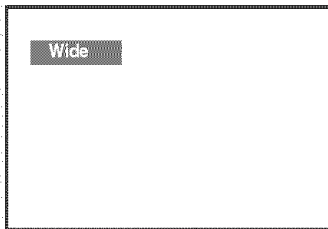

- **Wide:** Sets the picture to 16:9 wide mode.
- **Panorama:** Use this mode for the wide aspect ratio of a panoramic picture. (TX-R3065W)
- **Zoom1:** Magnifies the size of the picture on screen. You can also move the picture on screen by pressing the **▲** or **▼** button on the remote control.
- **Zoom2:** Magnifies the size of the picture more than Zoom1. You can also move the picture on screen by pressing the **▲** or **▼** button on the remote control.
- **4:3(Normal):** Sets the picture to 4:3 normal mode.

## Digital Noise Reduction

If the broadcast signal received by your TV is weak, you can activate the Digital Noise Reduction feature to help reduce any static and ghosting that may appear on the screen.

**1**

Press the **MENU** button.

Press the **▲** or **▼** button to select "Picture", then press the **ENTER** button.

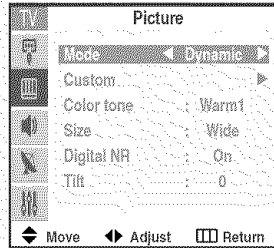

**2**

Press the **▲** or **▼** button to select "Digital NR".

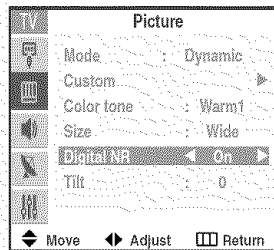

**3**

Press the **◀** or **▶** button to select "On" or "Off".

Press the **EXIT** button to exit.

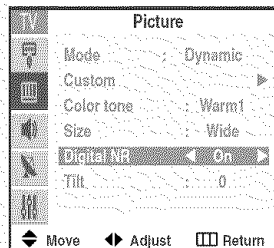

## Tilt

Due to the Earth's magnetic field there may be some minor image tilt depending on the TV's location. When this occurs, follow the steps below.

**1**

Press the **MENU** button.

Press the **▲** or **▼** button to select "Picture", then press the **ENTER** button.

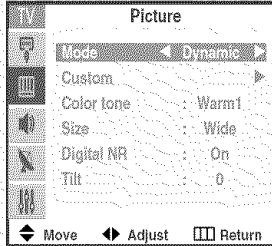

**2**

Press the **▲** or **▼** button to select "Tilt".

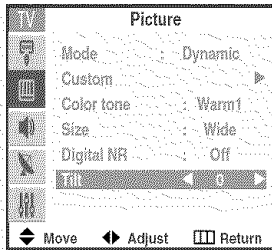

**3**

Press the **◀** or **▶** button to adjust the Tilt.

Press the **EXIT** button to exit.

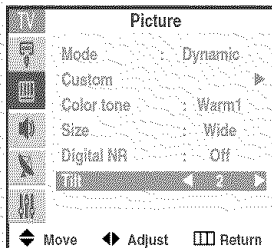

## Using the R.Surf Feature

This feature allows you to set the TV to return to a particular channel after a certain amount of time. For example, you may be watching a channel when commercials start. You can set the R.Surf to "5 minutes", then switch channels. After minutes, the TV will return to the original channel. To use the R.Surf feature:

**1**

While you are watching the channel to which you want to return, press the **R.SURF** button. The on-screen display will read "Surf off".

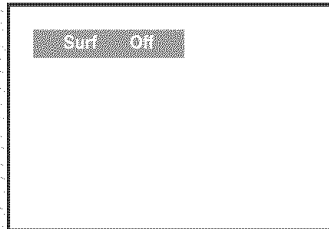

**2**

Press the **R.SURF** button again to set the timer in thirty second intervals, up to five minutes.

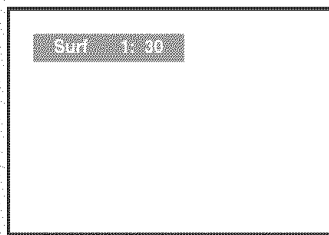

◀ The time will be decreasing while you are setting up the timer. And you will reset it when you pass five minutes or turn it off.

**3**

The time you set will begin counting down on the screen. When the time runs out, the TV will return to the channel you were watching when you set the timer.

## Freezing the Picture

Press the **STILL** button to freeze a moving picture. (normal sound will still be heard.)

Press again to cancel.

◀ Note: The still function doesn't operate in the COMPONENT mode.

## Choosing a Multi-Channel Sound (MTS) track

Depending on the particular program being broadcast, you can listen to Mono, Stereo, or a SAP.

**1**

Press the **MENU** button.

Press the **▲** or **▼** button to select "Sound", then press the **ENTER** button.

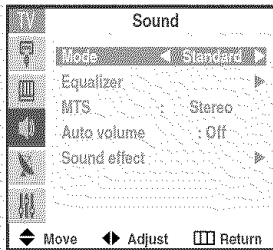

**2**

Press the **▲** or **▼** button to select "MTS".

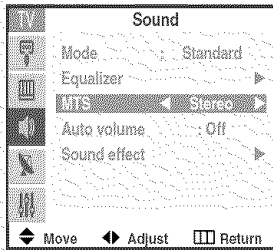

**3**

Press the **◀** or **▶** button to select a setting you want.

Press the **EXIT** button to exit.

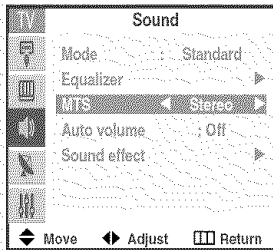

### Alternate method:

Press the **MTS** button on the remote control to select one of the settings.

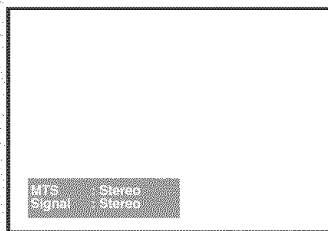

- Choose "Mono" for channels that are broadcasting in mono, or if you are having difficulty receiving a stereo signal.
- Choose "Stereo" for channels that are broadcasting in stereo.
- Choose "SAP" to listen to the Separate Audio Program, which is usually a foreign-language translation.

## Auto Volume

Each broadcasting station has its own signal conditions, and it is inconvenient to adjust the volume every time the channel is changed. “Auto Volume” automatically adjusts the volume of the desired channel by lowering the sound output when the modulation signal is high or by raising the sound output when the modulation signal is low.

**1**

Press the **MENU** button.

Press the **▲** or **▼** button to select “Sound”, then press the **ENTER** button.

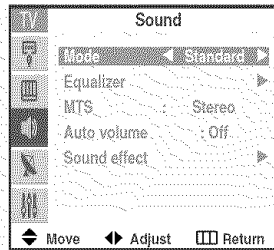

**2**

Press the **▲** or **▼** button to select “Auto volume”.

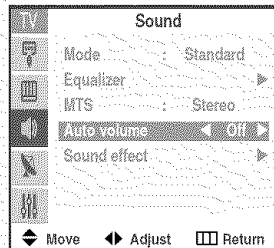

**3**

Press the **◀** or **▶** button to select “On” or “Off”.

Press the **EXIT** button to exit.

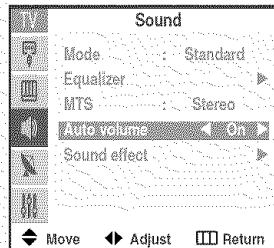

## Setting the Surround

Your Samsung TV can create a “surround” effect such that the sound seems to come from all directions. Once the “Surround” is set to “On”, the setting applies to sound effects such as “Standard”, “Music”, “Movie”, and “Speech”.

**1**

Press the **MENU** button.

Press the **▲** or **▼** button to select “Sound”, then press the **ENTER** button.

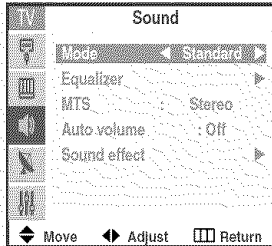

**2**

Press the **▲** or **▼** button to select “Sound effect”, then press the **ENTER** button.

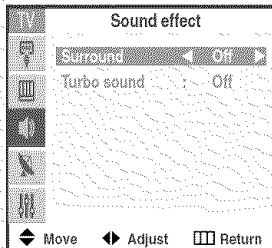

**3**

Press the **◀** or **▶** button to select “On” or “Off”.

Press the **EXIT** button to exit.

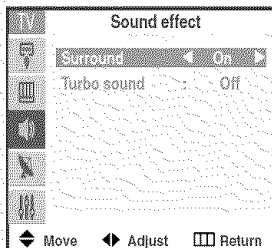

## Setting the Turbo Sound

Turbo sound emphasizes the bass and treble frequencies to add fullness to the sound.

**1**

Press the **MENU** button.

Press the **▲** or **▼** button to select "Sound", then press the **ENTER** button.

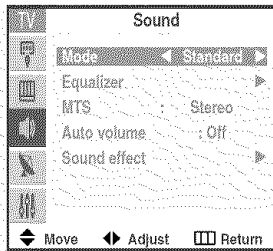

**2**

Press the **▲** or **▼** button to select "Sound effect", then press the **ENTER** button.

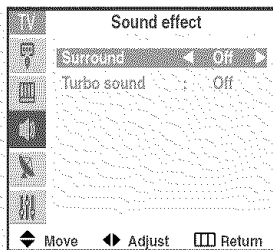

**3**

Press the **▲** or **▼** button to select "Turbo sound".

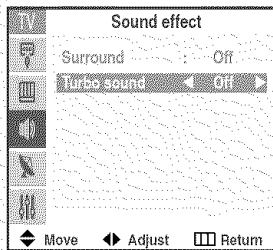

**4**

Press the **◀** or **▶** button to select "On" or "Off".

Press the **EXIT** button to exit.

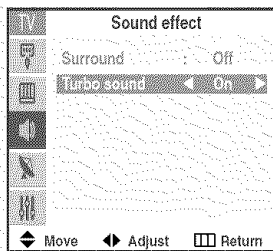

### Alternate method:

Press the **TURBO** button on the remote control to select the Turbo sound setting.

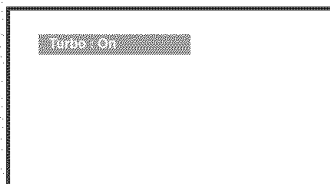

## Setting the On/Off Timer

**1**

Press the **MENU** button.

Press the **▲** or **▼** button to select "Setup", then press the **ENTER** button.

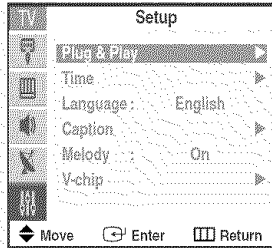

**2**

Press the **▲** or **▼** button to select "Time", then press the **ENTER** button.

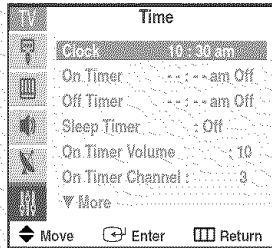

**3**

Press the **▲** or **▼** button to select "On Timer".

Press the **◀** or **▶** button to move the hour or minute. Set the clock you want by pressing the **▲** or **▼** button.

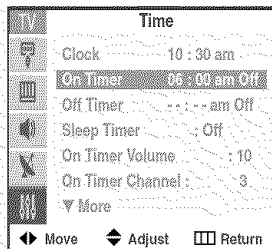

**4**

Press the **◀** or **▶** button to select "On" or "Off".

Press the **▲** or **▼** button to turn the on-timer "On". (To deactivate the "On Timer", select "Off".)

When you have finished, press the **▶** button.

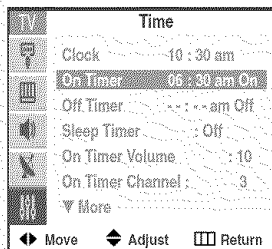

**5**

To set the Off Timer, press the **▲** or **▼** button to select "Off Timer".

Follow the same procedure as in steps 3-4 above.

Press the **EXIT** button to exit.

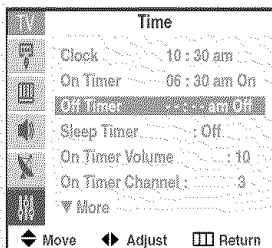

◀ Before using the timer, you must set the TV's clock. (See "Setting the Clock" on page 31).

◀ The current time will appear every time you press the **INFO** button.

You can set the hour and minute directly by pressing the number buttons on the remote control.

◀ **Auto Power Off**

When you set the timer "On", the television will eventually turn off, if no controls are operated for 3 hours after the TV was turned on by timer. This function is only available in timer "On" mode and prevents overheating or leakages, which may occur if a TV is on for too long (on holiday, for example).

## Setting the Sleep Timer

The sleep timer automatically shuts off the TV after a preset time (from 30 to 180 minutes).

### 1

Press the **MENU** button.

Press the **▲** or **▼** button to select "Setup", then press the **ENTER** button.

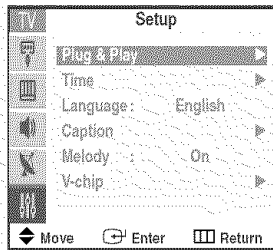

### 2

Press the **▲** or **▼** button to select "Time", then press the **ENTER** button.

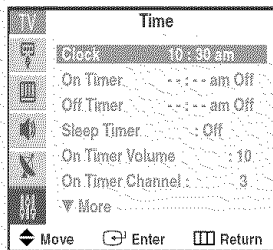

### 3

Press the **▲** or **▼** button to select "Sleep Timer".

Press the **◀** or **▶** button repeatedly until the appropriate time interval appears (any of the preset values from "Off" to "180").

Press the **EXIT** button to exit.

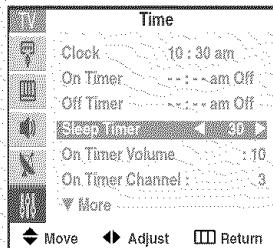

#### Alternate method:

Press the **SLEEP** button repeatedly until the appropriate time interval appears (any of the preset values from "Off" to "180").

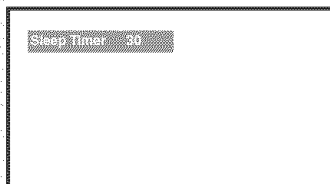

◀ After about 5 seconds, the sleep display will disappear from the screen, and the time interval will be set.

## Setting the Preferred Volume Level and Channel

The preferred volume and channel can be set for when the timer automatically turns on the TV.

**1**

Press the **MENU** button.

Press the **▲** or **▼** button to select "Setup", then press the **ENTER** button.

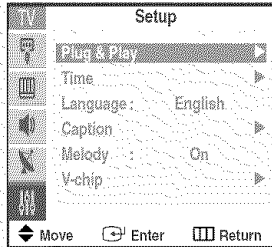

**2**

Press the **▲** or **▼** button to select "Time", then press the **ENTER** button.

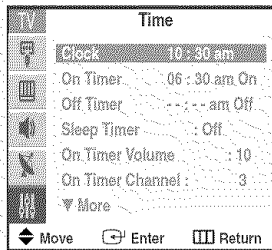

**3**

Press the **▲** or **▼** button to select "On Timer Volume".

Press the **◀** or **▶** button to adjust volume level.

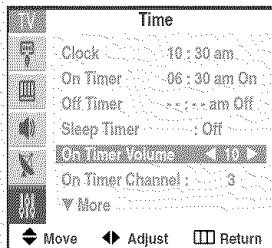

**4**

Press the **▲** or **▼** button to select "On Timer Channel".

Press the **◀** or **▶** button to select the channel you want.

Press the **EXIT** button to exit.

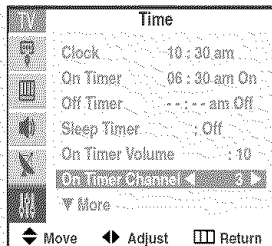

## Viewing Closed Captions

Your TV decodes and displays the closed captions that are broadcast with certain TV shows. These captions are usually subtitles for the hearing impaired or foreign-language translations. All VCRs record the closed caption signal from television programs, so home-recorded video tapes also provide closed captions. Most pre-recorded commercial video tapes provide closed captions as well. Check for the closed caption symbol in your television schedule and on the tape's packaging: **CC**.

**1**

Press the **MENU** button.

Press the **▲** or **▼** button to select "Setup", then press the **ENTER** button.

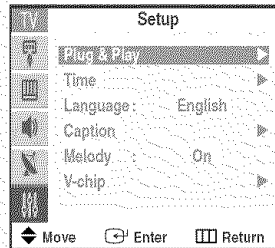

**2**

Press the **▲** or **▼** button to select "Caption", then press the **ENTER** button.

Press the **◀** or **▶** button to select "On".

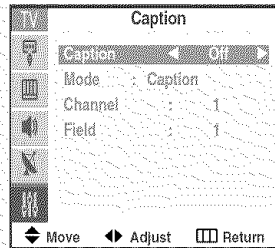

**3**

Press the **▲** or **▼** button to select "Mode".

Press the **◀** or **▶** button to select "Caption" or "Text".

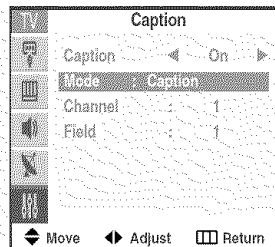

**4**

Press the **▲** or **▼** button to select "Channel" or "Field". Press the **◀** or **▶** button to select "1" or "2".

Press the **EXIT** button to exit.

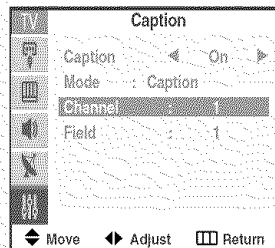

◀ Misspellings and unusual characters sometimes occur during closed caption transmissions, especially those of live events. There may be a small delay before captions appear when you change channels. These are not malfunctions of the TV.

◀ In "Caption" mode, captions appear at the bottom of the screen, and they usually cover only a small portion of the picture.

In "Text" mode, information unrelated to the program, such as news or weather, is displayed. Text often covers a large portion of the screen.

◀ Depending on the particular broadcast, it might be necessary to make changes to "Channel" and "Field".

◀ Different channels and fields display different information: "Field 2" carries additional information that supplements the information in "Field 1". (For example, "Channel 1" may have subtitles in English, while "Channel 2" has subtitles in Spanish.)

## Setting the On/Off Melody

You can hear a melody sound when the TV is powered On or Off.

**1**

Press the **MENU** button.

Press the **▲** or **▼** button to select "Setup", then press the **ENTER** button.

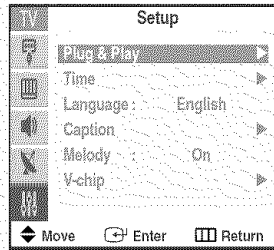

**2**

Press the **▲** or **▼** button to select "Melody".

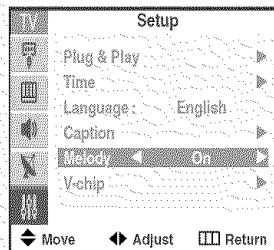

**3**

Press the **◀** or **▶** button to select "On" or "Off".

Press the **EXIT** button to exit.

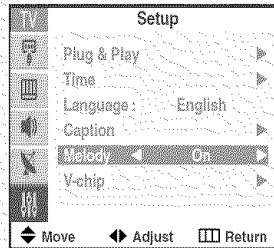

## Using the V-Chip

Access to channels and programs is controlled by a password (i.e., a 4-digit secret code that is defined by the user). The on-screen menu will instruct you to assign a password (and you can change it later, if necessary).

Note : When the V-chip feature is active, channel-auto program features do not function.

### How to Change Your Password

**1**

Press the **MENU** button.

Press the **▲** or **▼** button to select "Setup", then press the **ENTER** button.

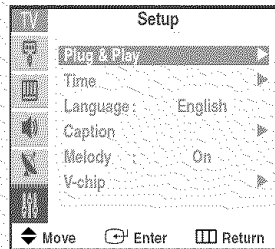

**2**

Press the **▲** or **▼** button to select "V-chip", then press the **ENTER** button.

Press the number buttons to enter your current 4-digit PIN.

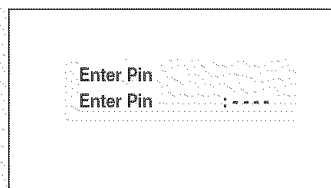

◀ The default PIN for a new TV set is "0 0 0 0".

◀ If you forget the PIN, press the remote control buttons in the following sequence, which resets the PIN to 0-0-0-0: **POWER** (Off), **MUTE**, **8**, **2**, **4**, **POWER** (On).

**3**

The "V-chip" menu is displayed.

Press the **▲** or **▼** button to select "Change Pin", then press the **ENTER** button.

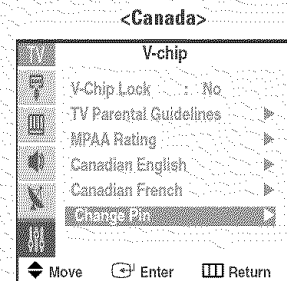
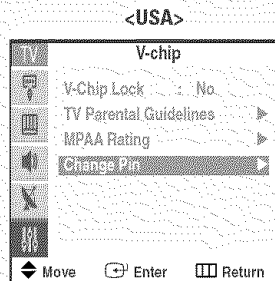

**4**

Press the number buttons (0 ~ 9) on the remote control to enter your current password.

Press the number buttons (0 ~ 9) to enter a new password.

Re-enter the new password to confirm.

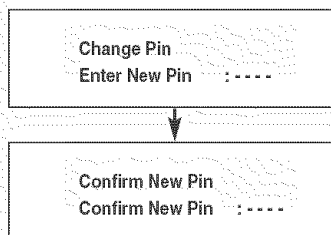

## How to Enable/Disable the Rating Controls

**1**  
Press the **MENU** button.

Press the **▲** or **▼** button to select "Setup", then press the **ENTER** button.

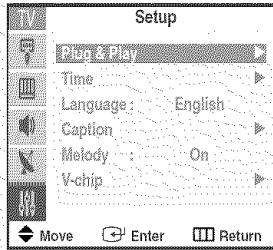

**2**  
Press the **▲** or **▼** button to select "V-chip", then press the **ENTER** button.

Press the number buttons to enter your current 4-digit PIN.

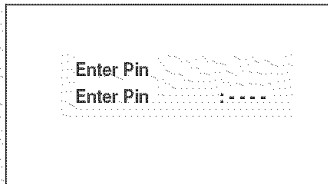

**3**  
The "V-chip" menu is displayed, with "V-Chip Lock" selected.

Press the **◀** or **▶** button to select "Yes" or "No".

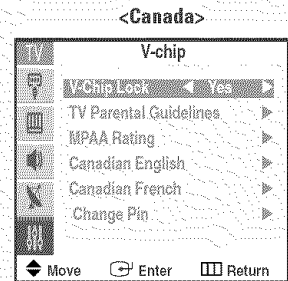
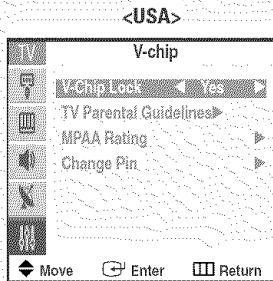

## How to Set up Restrictions Using the “TV Parental Guidelines”

The parental restrictions can be set up using either of two methods: The “TV Parental Guidelines” or “MPAA Rating”.

**1**  
Press the **MENU** button.

Press the **▲** or **▼** button to select “Setup”, then press the **ENTER** button.

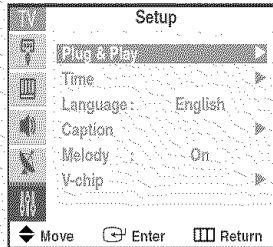

**2**  
Press the **▲** or **▼** button to select “V-chip”, then press the **ENTER** button.

Press the number buttons to enter your current 4-digit PIN.

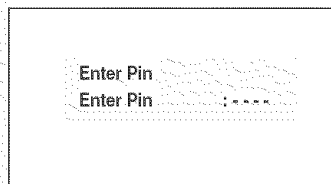

**3**  
Press the **▲** or **▼** button to select “TV Parental Guidelines”, then press the **ENTER** button.

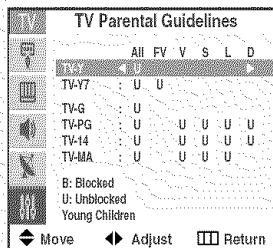

**4**  
You can independently lock the TV ratings. The locked TV (FCC) ratings are indicated by the “B”. Press the **▲** or **▼** button to select one of the six categories. Press the **▶** button to select the appropriate restriction. Press the **▲** or **▼** button to select “B” or “U”.

Press the **◀** button to save.

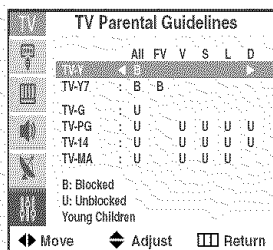

◀ **TV-Y** : Young children  
**TV-Y7** : Children 7 and over

-----  
**TV-G** : General audience  
**TV-PG** : Parent Guidance  
**TV-14** : Viewers 14 and over  
**TV-MA** : Mature Audience

- These categories consist of two separate groups: “TV-Y” and “TV-Y7” (young children through age 7), and “TV-G” through “TV-MA” (everybody else).
- The restrictions for these two groups work independently: If a household includes very young children as well as young adults, the TV parental guidelines must be set up separately for each age group. (See page 60.)

## How to Set up Restrictions using the Movie Ratings: G, PG, PG-13, R, NC-17, X

The Movie rating system uses the Motion Picture Association of America (MPAA) system, and its main application is for movies. When the Rating Control is on, the TV will automatically block any programs that are coded with objectionable ratings (either MPAA or TV-Ratings).

**1**

Press the **MENU** button.

Press the **▲** or **▼** button to select "Setup", then press the **ENTER** button.

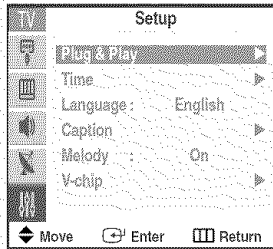

**2**

Press the **▲** or **▼** button to select "V-chip", then press the **ENTER** button.

Press the number buttons to enter your current 4-digit PIN.

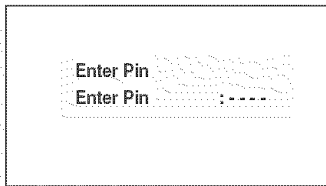

**3**

Press the **▲** or **▼** button to select "MPAA Rating", then press the **ENTER** button.

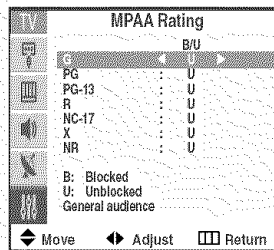

**4**

You can independently lock the movie ratings. The locked movie ratings are indicated by the "B".

Press the **▲** or **▼** button to select one of the categories, then press the **▶** button.

Press the **▶** button.

Press the **▲** or **▼** button to select "B" or "U".

Press the **◀** button to save.

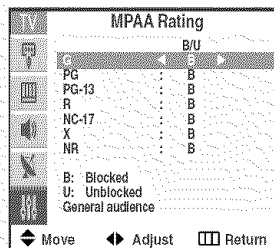

## Important Notes About Parental Locks

Explanation of the MPAA and TV (FCC) Rating Systems:

### TV (FCC) Age-Based Ratings

#### TV-MA

Mature audiences only. This program may contain mature themes, profane language, graphic violence and explicit sexual content.

#### TV-14

Parents strongly cautioned. This program may contain sophisticated themes, sexual content, strong language and more intense violence.

#### TV-PG

Parental guidance suggested. The program may contain infrequent coarse language, limited violence, some suggestive sexual dialog and situations.

#### TV-G

General audience. It contains little or no violence, no strong language, and little or no sexual dialog or situations.

#### TV-Y7

Directed to older children. Themes and elements in this program may include mild physical or comedic violence, or may frighten children under the age of seven.

#### TV-Y

All children. The themes and elements in this program are specifically designed for a very young audience, including children from ages two to six.

### TV (FCC) Content Category

<b>V</b>	Fantasy violence
<b>S</b>	Sexually Suggestive Dialog
<b>L</b>	Adult Language
<b>D</b>	Sexual situation
<b>FV</b>	Violence

### MPAA Rating System (Movies)

<b>G</b>	General audience (no restriction).
<b>PG</b>	Parental guidance suggested.
<b>PG-13</b>	PG-13 (Parents strongly cautioned).
<b>R</b>	R (Restricted. Children under 17 should be accompanied by an adult).
<b>NC-17</b>	No children under age 17.
<b>X</b>	X (Adults only).
<b>NR</b>	Not rated.

- TV (FCC) ratings: The particular rating that you have selected will be locked (and indicated as a red "L" on a blue background). Also, all of the age-based ratings will be locked within the particular group (i.e., "group 1" or "group 2").  
Suppose that the TV-G rating and all of its contents (V, S, L, and D) are locked. In that case, more restrictive ratings (TV-PG, TV-14, and TV-MA) and all of their contents (V, S, L, and D) are automatically locked as well.
- MPAA ratings: The particular rating that you have selected will be locked. In addition, more restrictive ratings will be locked as well.
- Neither TV (FCC) ratings nor MPAA ratings apply to news programs.

## How to Set up Restrictions Using the “Canadian English”

**1**

Press the **MENU** button.  
Press the **▲** or **▼** button to select “Setup”, then press the **ENTER** button.

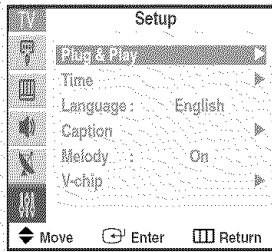

**2**

Press the **▲** or **▼** button to select “V-chip”, then press the **ENTER** button.

Press the number buttons to enter your current 4-digit PIN.

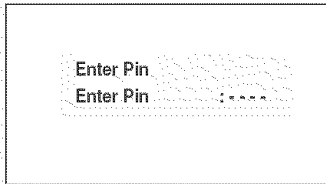

**3**

Press the **▲** or **▼** button to select “Canadian English”, then press the **ENTER** button.

The “Canadian English” menu is displayed.

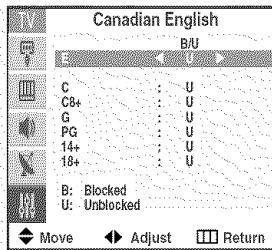

**4**

Press the **▲** or **▼** button to select one of the categories, then press the **▶** button.  
Pressing the **▲** or **▼** button to select “B” or “U”.

Press the **◀** button to save.

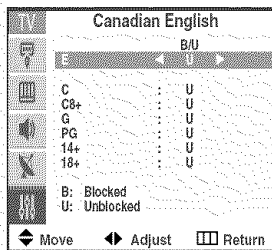

- E** Exempt programming includes...news, sports, documentaries and other information programming, talk shows, music videos, and variety programming.
- C** Programming intended for children under age 8.
- C8+** Programming generally considered acceptable for children 8 years and over to watch on their own.
- G** General programming, suitable for all audiences.
- PG** Parental Guidance.
- 14+** Programming contains themes or content which may not be suitable for viewers under the age of 14.
- 18+** Adult programming.

## How to Set up Restrictions Using the “Canadian French”

**1**

Press the **MENU** button.

Press the **▲** or **▼** button to select “Setup”, then press the **ENTER** button.

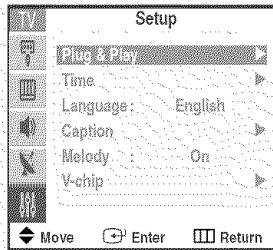

**2**

Press the **▲** or **▼** button to select “V-chip”, then press the **ENTER** button.

Press the number buttons to enter your current 4-digit PIN.

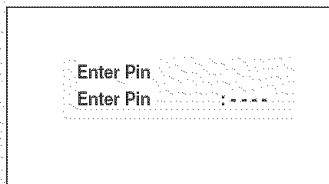

**3**

Press the **▲** or **▼** button to select “Canadian French”, then press the **ENTER** button.

The “Canadian French” menu is displayed.

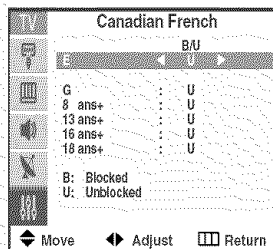

**4**

Press the **▲** or **▼** button to select one of the categories, then press the **▶** button. Pressing the **▲** or **▼** button to select “B” or “U”.

Press the **◀** button to save.

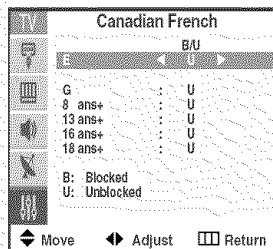

**E** Exempt programming includes...news, sports, documentaries and other information programming, talk shows, music videos, and variety programming.

**G** General.

**8 ans+** 8+ General-Not recommended for young children.

**13 ans+** Programming may not be suitable for children under the age of 13.

**16 ans+** Programming is not suitable for children under the age of 16.

**18 ans+** Programming restricted to adults.

## How to Reset the TV after the V-Chip Blocks (“Emergency Escape”)

If the TV is tuned to a restricted channel, the V-Chip will block it. The screen will go blank and the following message will appear: “Excessive rating.”

To resume normal viewing, tune to a different channel using the number buttons. Under certain conditions (depending on the rating of the local TV programs) the V-Chip might lock out all the channels. In this case, use the V-Chip function for an “emergency escape”:

Press the **MENU** button.

Press the **▲** or **▼** button to select “Setup”, then press the **ENTER** button.

Press the **▲** or **▼** button to select “V-chip”, then press the **ENTER** button.

Enter your PIN, then press the **▶** button to temporarily disable the “V-Chip Lock”.

Press the **EXIT** button to exit.

## Customizing Your Remote Control

Your TV comes equipped with a universal remote control. In addition to controlling the TV, the universal remote control can also operate a VCR, Cable box, DVD, and Samsung set-top box (even if your VCR, Cable box and DVD are made by manufacturers other than Samsung).

- The remote control might not be compatible with all VCRs, DVD players and Cable boxes.

### Setting Up Your Remote Control to Operate Your VCR (Cable box or DVD player)

**1**

Turn off your VCR (Cable box or DVD player).

**2**

Press the **MODE** button to switch the remote control to the **VCR (CABLE or DVD)** mode.

- ◀ The remote control has five modes: TV, STB, VCR, CABLE and DVD.

**3**

On your Samsung remote control, press the **SET** button.

**4**

Enter 3 digits of the VCR (Cable box or DVD player) code listed on next page for your brand of VCR (Cable box or DVD player).

- ◀ Make sure you enter 3 digits of the code, even if the first digit is a "0". (If more than one code listed, try the first one.)

**5**

Press the **POWER** button on the remote control. Your VCR (Cable box or DVD player) should turn on. If your VCR (Cable box or DVD player) turns on, your remote control is now set correctly.

- ◀ If your VCR (Cable box or DVD player) does not turn on, repeat steps 2, 3, and 4, but try one of the other codes listed for the brand of your particular VCR (Cable box or DVD player).

**6**

Once your remote control is set up, press the **MODE** button any time you want to use the remote to operate your VCR (Cable box or DVD player).

- When your remote is in the **TV** mode, the VCR (or DVD player) control buttons (**REW**, **STOP**, **PLAY/PAUSE** and **FF**) will still operate your VCR (or DVD player).
- When your remote control is in the **STB**, **VCR**, **CABLE**, or **DVD** mode, the volume buttons still control your TV's volume.

# SPECIAL FEATURES

## Remote Control Codes

### VCR Codes

000	Samsung	018	Candle, Citizen, Emerson, LG(Goldstar), Radio Shack, Realistic, Sears, Toshiba, Teknika, Television	036	Electrohome, Emerson, Radio Shack, Realistic, Sharp	059	Pioneer			
001	LG(Goldstar)			037	RCA	060	JC Penny			
002					038	Magnavox, Marantz, Philco, Philips, Sylvania	061	Candle, Citizen, Portland		
003	Daewoo	019	Broksonic, Emerson	039	JC Penny, JCL, Kenwood, Marantz, NEC, Tatung, Teac	062	Canon, Curtis Mathes, General Electric, JC Penny, Magnavox, Panasonic, Philco, Radio Shack, Realistic, Sylvania			
004			021					Craig, Fisher, Radio Shack, Realistic, Sanyo, Sears		
005					040			Logik, Multitech, Shintom	063	RCA
006					041			General Electric, Multitech, Samsung	064	Shintom
007	Daewoo, LG(Goldstar)	022	Audio Dynamics, Candle, Citizen, Daewoo, Emerson, Samsung, Scott, Toshiba	042	Pioneer	065	Magnavox, Philco, Sylvania			
008	Daewoo	023	Colorlyme, Curtis Mathes, DB, LG(Goldstar), Harman Kardon, JC Penny, JCL, Kenwood, Marantz, NEC	043	Emerson	066	Emerson			
009	Curtis Mathes, Dimensia, General Electric, PROSCAN, RCA			044	Hitachi, JC Penny, Pentax, RCA, Sears	045	Hitachi	067	Fisher	
011	Bell & Howell, Fisher, JC Penny, JCL, Kenwood, Marantz, NEC, Quartz, Radio Shack, Realistic, Sanyo, Sears, Tandy	024	Aiwa, Curtis Mathes, Dynatech, Emerson, Funai, Hitachi, Lloyd, LXL, MTC, Multitech, Radio Shack, Realistic, Signature, Sylvania, Symphonic, Tandy, Teac, Teknika	046	RCA	069	LG(Goldstar)			
014	Hitachi, JC Penny, Pentax, Pioneer, RCA, Sears, Toshiba	025	Audio Dynamics, DB, JC Penny, JCL, Kenwood, Marantz, NEC, Pioneer, Sansui	047	Sony	070	Marantz, NEC			
015	Admiral, Optimus, Radio Shack, Realistic, Sharp			048	Sharp	049	Emerson, Scott	071	Emerson	
016	Candle, Citizen, Craig, Curtis Mathes, General Electric, Go Video, JC Penny, MTC, Multitech, RCA, Samsung, Television	026	Akai, Shintom, Sony	050	Emerson, Samsung	072	Curtis Mathes, NEC			
017	Canon, Curtis Mathes, Emerson, General Electric, Instant Replay, JC Penny, JCL, Magnavox, Marantz, Panasonic, Philco, Philips, Quasar, Radio Shack, Realistic, RCA, Sylvania, Technics, Teknika	027	Fisher, Sears	051	Fisher, Radio Shack, Realistic, Sears	073	Emerson			
		028	Fisher, Radio Shack, Realistic, Sears, Toshiba	052	Portland, Quasar	074	RCA, Teac			
		029	Emerson	053	Candle, Citizen, Daewoo, Portland, Sharp	075	Emerson			
		030	Teknika	054	Candle, Citizen, Curtis Mathes, LG(Goldstar), JCL, Kenwood, Marantz, NEC, Pentax Research+	076	Curtis Mathes, Emerson, TMK			
		031	Akai, Samsung	055	Emerson	077	Emerson, Scott			
		032	Akai, Emerson	056	Emerson	078	RCA, Teac			
035	Shintom, Sony	057	Fisher, Sears, Toshiba	058	Emerson, Scott, Toshiba	079	Emerson			
						082	KLH			
						084	Panasonic			
						085	Daewoo			
						086	Panasonic			
						088	Admiral			

### Cable Box Codes

000	Samsung	020	Eastern International, Hamlin, Regal	038	GI, Jerrold	057	Tocom
001	Nawoo	021	Hamlin, Regal	039	Unika	058	
002	TaePyungYang			022	Zenith	040	Magnavox, Philips, Unika, Viewstar
003	DeoRyung	023	GI, Jerrold	041	Magnavox, Philips, Regency, Viewstar	060	Tocom
004	DongKuk	024	Oak, Osk Sigma			042	Hamlin
005	DaehAn	025	Tocom	043	GI, Jerrold	062	StarGate 2000
006	LG(Goldstar)	026	Pioneer	044	Hitachi, Macom	063	Sylvania, Texscan
007	Saewoo	027	Magnavox, Philips, Viewstar	045	Oak	064	Panasonic, Zenith
008	RCA	028	Pioneer	046	Panasonic	065	Jerrold
010	Regency	029	Magnavox, Philips, Tocom, Viewstar	047	Magnavox, Philips, Viewstar	066	Samsung
011	Hamlin, Panasonic, Regal, Samsung	030	Samsung	048	Magnavox, Philips, Unika, Viewstar	067	Jerrold
012	GI, Hamlin, Jerrold	031	GI, Jerrold	049	Zenith	068	RCA
013	GI, Jerrold	032	Magnavox, Philips, Viewstar	050	Hitachi, Macom	069	GI
015	Anvission, Cable Star, Eagle, Magnavox, Philips, Randtek, Viewstar	033	RCA, Panasonic, Sprucer	051	Pioneer, Samsung, Warner Amex	070	
017	NSC	034	Magnavox, Philips, Viewstar	052	General Instrument, Hitachi, Jerrold, Signature, Starcom	071	
019	Sylvania, Texscan	035	Magnavox, Philips, Viewstar	053	Hamlin	072	

### DVD Codes

000	Samsung	003	JVC	006	Panasonic	009	Curtis Mathes
001	LG(Goldstar)	004	Sony	007	Philips		
002	Toshiba	005	Sharp	008	PROSCAN, RCA		

# Chapter Five

## TROUBLESHOOTING

If the TV seems to have a problem, first try this list of possible problems and solutions. If none of these troubleshooting tips apply, then call your nearest Samsung authorized service center.

### Identifying Problems

Problem	Possible Solution
Poor picture.	Try another channel. Adjust the antenna. Check all wire connections.
Poor sound quality.	Try another channel. Adjust the antenna.
No picture or sound.	Try another channel. Press the <b>TV/VIDEO</b> button. Make sure the TV is plugged in. Check the antenna connections. Make sure the <b>MUTE</b> button is off.
No color, wrong colors or tints.	Make sure the program is broadcast in color. Adjust the picture settings.
Picture rolls vertically.	Adjust the antenna. Check all wire connections. If you are using a VCR, check the tracking.
The TV operates erratically.	Unplug the TV for 30 seconds, then try operating it again.
Your remote control does not operate your TV.	Press the <b>MODE</b> button to put your remote control in the "TV" mode. Make sure the remote has batteries. Check that the "+" and "-" ends of the batteries are inserted correctly. Check that the batteries are drained.
The TV won't turn on.	Make sure the wall outlet is working. Make sure the TV is plugged in. Make sure the remote has batteries.

## Cleaning and Maintaining Your TV

Please follow these guidelines to get the maximum performance from your TV.

### Placement

- Do not place the TV near extremely hot, cold, humid or dusty places.
- Do not place the TV near appliances with electric motors that create magnetic fields, such as vacuum cleaners.
- Keep the ventilation openings clear; do not place the TV on a soft surface, such as cloth or paper.
- Place the TV in a vertical position only.

### Liquids

- Do not handle liquids near or on the TV. Liquids that spill into it can cause serious damage.

### Cabinet

- Never open the cabinet or touch the parts inside.
- Wipe your TV with a clean, dry cloth. Never use water, cleaning fluids, wax, or chemicals.
- Do not put heavy objects on top of the cabinet.

### Temperature

- If your TV is suddenly moved from a cold to a warm place, unplug the power cord, and allow at least two hours for moisture that may have formed inside the unit to dry completely.

## Using Your TV in Another Country

If you plan to take your TV with you to a foreign country, please be aware of the different television systems that are in use around the world. A TV designed for one system may not work properly with another system due to differences in the TV channel frequencies.

## Specifications

Model	XTX-R2764 TX-R3264	TX-R2765 TX-R3065W TX-R3265
Voltage	AC120 V	AC120 V
Frequency of Operation	60 Hz	60 Hz
Dimensions (mm/inches)	762 x 519 x 600 / 30.0 x 20.4 x 23.6 911 x 579 x 703 / 35.9 x 22.8 x 27.7	776 x 505 x 575 / 30.6 x 19.9 x 22.6 920 x 562 x 560 / 36.2 x 22.1 x 22.1 920 x 562 x 685 / 36.2 x 22.1 x 27.0
Weight (Kg/ lbs)	47.5 / 104.7 67.0 / 147.7	42.5 / 93.7 53.8 / 118.6 64.0 / 141.1

APPENDIX

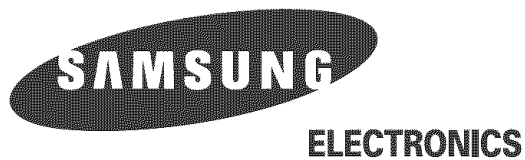

**1-800-SAMSUNG (1-800-726-7864)**

**Samsung Electronics America  
Service Division**

400 Valley Road, Suite 201  
Mount Arlington, NJ 07856  
[www.samsung.com](http://www.samsung.com)

**Samsung Electronics Canada Inc.  
Samsung Customer Care**

7037 Financial Drive  
Mississauga, Ontario  
L5N 6R3  
[www.samsung.ca](http://www.samsung.ca)

AA68-03447B-00