

Viking Use & Care Manual

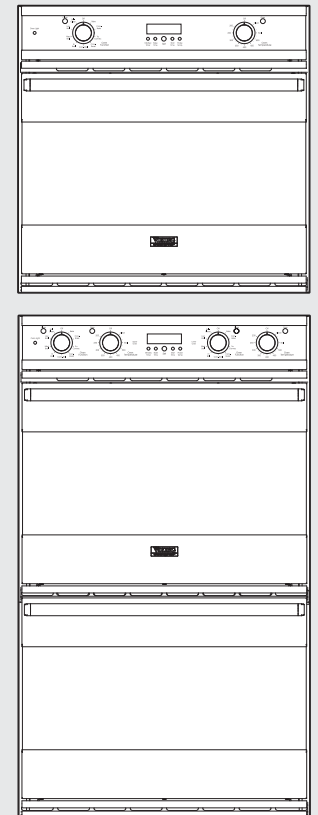

Viking Range Corporation
111 Front Street
Greenwood, Mississippi 38930 USA
(662) 455-1200

For product information,
call 1-888-VIKING1 (845-4641)
or visit the Viking Web site at
vikingrange.com



Designer Series Built-In Electric
Single and Double Ovens

Congratulations

Your purchase of this product attests to the importance you place upon the quality and performance of the major appliances you use. With minimal care, as outlined in this guide, this product is designed to provide you with years of dependable service. Please take the few minutes necessary to learn the proper and efficient use and care of this quality product.

Some of the key features of this appliance include:

- A broad range of baking and broiling modes—up to 11 cooking modes in all—to make even your most challenging baking projects a success.
- A two-speed convection fan that allows you to cook foods more thoroughly and evenly—even when baking large quantities.
- Four convection modes offering greater air circulation to shorten cooking times and cook foods more evenly.
- Dual broiling elements producing intense radiant heat for faster broiling and a larger coverage area.
- Three broiling modes including a new low-broil mode for delicate broiling and top-browning.
- A halogen lighting system to provide more light with less glare.
- A concealed bake element for easier cleaning.
- Six adjustable rack positions with the largest usable baking space available in this class.

Your complete satisfaction is our ultimate goal. If you have any questions or comments about this product, please contact the dealer from whom you purchased it, or contact our Consumer Support Center at 1-888-VIKING1 (845-4641).

We appreciate your choosing a Viking Range Corporation product and hope that you will again select our products for your other major appliance needs. For more information about the complete and growing selection of Viking products, contact your dealer or visit us online at vikingrange.com

Table of Contents

Getting Started

Warnings & Safety	4
Before Using Oven	12

Product Controls

Setting the Clock	13
Oven Control Panel	14
Oven Features	16
Clocks and Timers	17
Oven Functions and Settings	20

Operation

Using the Oven	22
Preheat	22
Meat Probe Function	22
Rack Positions	23
Conventional and Convection Cooking	24
Condensation	26
Pan Placement Tips	27
Baking	28
BAKE (Two-Element Bake)	28
CONV BAKE (Convection Bake)	28
TRU CONV (TruConvec™)	29
Solving Baking Problems	32
Roasting	33
CONV ROAST (Convection Roast)	33
Broiling	38
CONV BROIL (Convection Broil)	38
HI BROIL	38
MED BROIL	38
LOW BROIL	39
Convection Dehydrate/Defrost	42

Product Care

Cleaning and Maintenance	43
Self-Clean Cycle	45
Replacing Oven Lights	47
Troubleshooting	48
Service Information	49

Warnings & Safety

Warning and Important Safety Instructions appearing in this manual are not meant to cover all possible conditions and situations that may occur. Common sense, caution, and care must be exercised when installing, maintaining, or operating the appliance.

ALWAYS contact the manufacturer about problems or conditions you do not understand.

Recognize Safety Symbols, Words, Labels

⚠ DANGER
Hazards or unsafe practices which WILL result in severe personal injury or death
⚠ WARNING
Hazards or unsafe practices which COULD result in death or severe personal injury
⚠ CAUTION
Hazards or unsafe practices which COULD result in minor personal injury.
All safety messages will identify the hazard, tell you how to reduce the chance of injury, and tell you what can happen if the instructions are not followed.

Read and follow all instructions before using this appliance to prevent the potential risk of fire, electric shock, personal injury or damage to the appliance as a result of improper usage of the appliance. Use appliance only for its intended purpose as described in this manual.

To ensure proper and safe operation: Appliance must be properly installed and grounded by a qualified technician. **DO NOT** attempt to adjust, repair, service, or replace any part of your appliance unless it is specifically recommended in this manual. All other servicing should be referred to a qualified servicer.

KEEP THESE INSTRUCTIONS FOR FUTURE REFERENCE.

Warnings & Safety

⚠ WARNING

DO NOT use commercial oven cleaners inside the oven. Use of these cleaners can produce hazardous fumes or can damage the porcelain finishes.

⚠ WARNING

NEVER cover any slots, holes or passages in the oven bottom or cover an entire rack with materials such as aluminum foil. Doing so blocks air flow through the oven and may cause carbon monoxide poisoning. Aluminum foil linings may also trap heat, causing a fire hazard.

⚠ WARNING



To avoid risk of property damage, personal injury or death; follow information in this manual exactly to prevent a fire or explosion. **DO NOT** store or use gasoline or other flammable vapors and liquids in the vicinity of this or any appliance.

Warnings & Safety

To Prevent Fire or Smoke Damage

- Be sure all packing materials are removed from the appliance before operating it.
- Keep area around appliance clear and free from combustible materials, gasoline, and other flammable vapors and materials.
- Many aerosol-type spray cans are **EXPLOSIVE** when exposed to heat and may be highly flammable. Avoid their use or storage near an appliance.
- Many plastics are vulnerable to heat. Keep plastics away from parts of the appliance that may become warm or hot.
- Combustible items (paper, plastic, etc.) may ignite and metallic items may become hot and cause burns. **DO NOT** leave oven unsupervised when drying herbs, breads, mushrooms, etc., as this may create a fire hazard.

In Case of Fire

Turn off appliance to avoid spreading the flame.

- Smother fire or flame by closing the oven door.
- **DO NOT** use water on grease fires. Use baking soda, a dry chemical or foam-type extinguisher to smother fire or flame.

Child Safety

- **NEVER** leave children alone or unsupervised near the appliance when it is in use or is still hot.
- **DO NOT** store items of interest to children over the unit. Children climbing to reach items could be seriously injured.
- Children must be taught that the appliance and utensils in it can be hot. Let hot utensils cool in a safe place, out of reach of small children. Children should be taught that an appliance is not a toy. Children should not be allowed to play with controls or other parts of the appliance.

Warnings & Safety

Cooking Safety

- Use dry, sturdy pot-holders. Damp pot-holders may cause burns from steam. Dish towels or other substitutes should **NEVER** be used as potholders because they can get caught on appliance parts.
- Loose-fitting or hanging garments should never be worn while using the appliance. **DO NOT** drape towels or materials on oven door handles. These items could ignite and cause burns.
- **ALWAYS** place oven racks in the desired positions while oven is cool. Slide oven rack out to add or remove food, using dry, sturdy pot-holders. **ALWAYS** avoid reaching into the oven to add or remove food. If a rack must be moved while hot, use a dry pot-holder.
- **ALWAYS** turn the oven off at the end of cooking.
- **DO NOT** heat unopened food containers; buildup of pressure may cause the container to explode and result in injury.
- Use care when opening the oven door. Let hot air or steam escape before moving or replacing food.
- **NEVER** use aluminum foil to cover oven racks or oven bottom. This could result in risk of electric shock, fire, or damage to the appliance. Use foil only as directed in this guide.
- **PREPARED FOOD WARNING:** Follow food manufacturer's instructions. If a plastic frozen food container and/or its cover distorts, warps, or is otherwise damaged during cooking, immediately discard the food and its container. The food could be contaminated.

Heating Elements

- **NEVER** touch oven heating elements, areas near elements, or interior surfaces of oven.
- Heating elements may be hot even though dark in color. Areas near elements and interior surfaces of an oven may become hot enough to cause burns.
- During and after use, **DO NOT** touch or let clothing or other flammable materials contact heating elements, areas near elements, or interior surfaces of oven until they have had sufficient time to cool.

Self-Clean Oven

- Clean only parts listed in this guide. **DO NOT** clean door gasket. The door gasket is essential for a good seal. Care should be taken not to rub, damage, or move the gasket. **DO NOT** use oven cleaners of any kind in or around any part of the self-clean oven.
- Before self-cleaning the oven, remove broiler pan, oven racks and other utensils and wipe up excessive spill-overs to prevent excessive smoke, flare-ups or flaming.
- This oven features a cooling fan which operates automatically during a clean cycle. If the fan does not turn on, the unit will not operate. The user should contact Service for repair.

Warnings & Safety

Important Safety Notice and Warning

The California Safe Drinking Water and Toxic Enforcement Act of 1986 (Proposition 65) requires the Governor of California to publish a list of substances known to the State of California to cause cancer or reproductive harm, and requires businesses to warn customers of potential exposures to such substances. Users of this appliance are hereby warned that when the oven is engaged in the self-clean cycle, there may be some low-level exposure to some of the listed substances, including carbon monoxide. Exposure to these substances can be minimized by properly venting the oven to the outdoors by opening the windows and/or door in the room where the appliance is located during the self-clean cycle.

Important notice regarding pet birds:

NEVER keep pet birds in the kitchen or in rooms where the fumes from the kitchen could reach. Birds have a very sensitive respiratory system. Fumes released during an oven self-cleaning cycle may be harmful or fatal to birds. Fumes released due to overheated cooking oil, fat, margarine and overheated non-stick cookware may be equally harmful.

About Your Appliance

⚠ WARNING

NEVER use appliance as a space heater to heat or warm a room to prevent potential hazard to the user and damage to the appliance. Also, **DO NOT** use the oven as a storage area for food or cooking utensils.

⚠ WARNING

To prevent possible damage to cabinets and cabinet finishes, use only materials and finishes that will not discolor or delaminate and will withstand temperatures up to 194°F (90°C). Heat and moisture resistant adhesive must be used if the product is to be installed in laminated cabinetry. Check with your builder or cabinet supplier to make sure that the materials meet these requirements.

- For proper oven performance and operation, **DO NOT** block or obstruct the any vents above or below the doors.
- Avoid touching oven vent area while oven is on and for several minutes after oven is turned off. When the oven is in use, the vent and surrounding area become hot enough to cause burns. After oven is turned off, **DO NOT** touch the oven vent or surrounding areas until they have had sufficient time to cool.

Warnings & Safety

- Other potentially hot surfaces include oven vent, surfaces near the vent opening, oven door, areas around the oven door, and oven window.
- The misuse of oven doors (e.g. stepping, sitting, or leaning on them) can result in potential hazards and/or injuries.

⚠ WARNING



ELECTRICAL SHOCK HAZARD

DO NOT touch a hot oven light bulb with a damp cloth as the bulb could break. Should the bulb break, disconnect power to the appliance before removing bulb to avoid electrical shock.

⚠ WARNING



ELECTRICAL SHOCK HAZARD

Disconnect the electric power at the main fuse or circuit breaker before replacing bulb.

⚠ WARNING



BURN OR ELECTRICAL SHOCK HAZARD

Make sure all controls are "OFF" and oven is COOL before cleaning. Failure to do so can result in burns or electrical shock.

⚠ WARNING

This appliance features a self-cleaning cycle. During this cycle, the oven reaches elevated temperatures in order to burn off soil and deposits. A powder ash residue is left in the bottom of the oven after completion of the self-clean cycle.

Note: DO NOT use commercial oven cleaners inside the oven. Use of these cleaners can produce hazardous fumes or can damage the porcelain finishes. **DO NOT** line the oven with aluminum foil or other materials. These items can melt or burn during a self-clean cycle, causing permanent damage to the oven.

Warnings & Safety

⚠ WARNING



BURN HAZARD

When self-cleaning, surfaces may get hotter than usual. Therefore, children should be kept away.

⚠ WARNING

To avoid sickness and food waste when using automatic time baking:

- **DO NOT** use foods that will spoil while waiting for cooking to start, such as dishes with milk or eggs, cream soups, custards, fish, pork, poultry, or foods with stuffing.
- Any food that has to wait for cooking to start should be very cold or frozen before it is placed in the oven.
- **DO NOT** use foods containing baking powder or yeast with automatic time baking. They will not rise properly.
- **DO NOT** allow food to remain in the oven for more than 2 hours after the end of the cooking cycle.
- To avoid sickness and food waste, **DO NOT** allow defrosted food to remain in the oven for more than 2 hours.

⚠ CAUTION



DO NOT touch the exterior portions of the oven after self-cleaning cycle has begun, since some parts become extremely hot to the touch!

During the first few times the self-cleaning feature is used, there may be some odor and smoking from the “curing” of the binder in the high-density insulation used in the oven. When the insulation is thoroughly cured, this odor will disappear. During subsequent self-cleaning cycles, you may sense an odor characteristic of high temperatures.

KEEP THE KITCHEN WELL-VENTED DURING THE SELF-CLEAN CYCLE.

⚠ CAUTION

DO NOT store items of interest to children over the unit. Children climbing to reach items could be seriously injured.

Warnings & Safety

⚠ CAUTION



BURN HAZARD

The oven door, especially the glass, can get hot. **Danger of burning: DO NOT touch the glass!**

⚠ CAUTION

You must carefully check the food during the dehydration process to ensure that it does not catch fire.

⚠ NOTICE

The cooling fan should be operating when the unit is in operation. If you notice the cooling fan is not operating or you observe unusual or excessive noise coming from the cooling fan, contact a Viking Authorized Service Center before continuing operation. Failure to do so can result in damage to the oven or surrounding cabinets.

⚠ NOTICE

Avoid any damage to oven vents. The vents need to be unobstructed and open to provide proper airflow for optimal oven performance.

⚠ NOTICE

DO NOT turn the Temperature Control on during defrosting. Turning the convection fan on will accelerate the natural defrosting of the food without the heat.

Before Using Oven

Oven

Important! Before first use, wipe interior with soapy water and dry thoroughly. Then set the oven selector to "BAKE", the thermostat to 350°F, and operate for an hour.

All models include:

- A broad range of baking and broiling modes—up to eleven cooking modes in all—to make even your most challenging baking projects a success.
- A two-speed convection fan—this allows you to cook foods more thoroughly and evenly—even when baking large quantities.
- Four convection modes offering greater air circulation to shorten cooking times and cook foods more evenly.
- Three broiling modes including a new low-broil mode for delicate broiling and top-browning.
- A concealed bake element for easier cleaning.
- This appliance is certified by Star-K to meet strict regulations in conjunction with specific instructions found on www.star-k.org

Setting the Clock

(DSOE301 and DDOE301 models)

The time-of-day must be set before any other program can be used. When your oven is first connected to the power in your home, the timer display will show --:--.

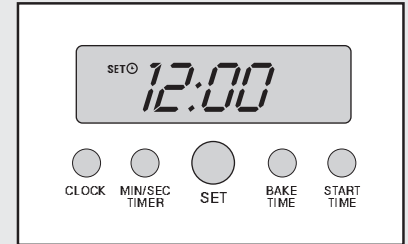

To program the time-of-day:

1. Press the "CLOCK" button once. 12:00 will be displayed with the word "SET" in the upper left corner.
2. Turn the "SET" knob until the correct time-of-day is displayed. AM and PM are not indicated.
3. Press the "CLOCK" button again. The word SET will disappear and the correct time is now set into the timer.

The time-of-day can be changed by following steps 1 through 3. It cannot be changed while there is a BAKE TIME or START TIME cycle programmed into the timer.

(DDOE305 model)

The time-of-day must be set before any other program can be used. When your oven is first connected to the power in your home, the timer display will show --:--.

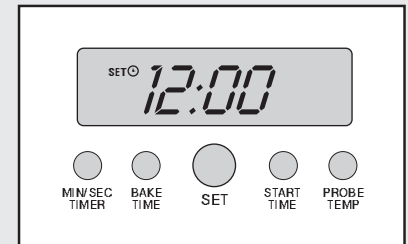

To program the time-of-day:

1. Push and hold the "MIN/SEC TIMER" and "BAKE TIME" buttons simultaneously.
2. Turn the "SET" knob until correct time is displayed on the digital clock.
3. Release hold from "MIN/SEC TIMER" and "BAKE TIME" buttons.

Oven Control Panel

Oven Control Panel

Interior Oven Light Control
The oven has interior oven lights that are controlled by one switch on the control panel. Push the switch to turn the interior oven lights "ON" and "OFF".

Electronic Timing Center
The Electronic Timing Center is used to program and control all timing functions.

Temperature Control
Each oven has a separate temperature control dial. The controls can be set at any temperature from 200°F (93°C) to 550°F (288°C).
ALWAYS be sure the controls are in the "OFF" position when the ovens are not in use.

IMPORTANT: The time-of-day must be set before any other program can be used.

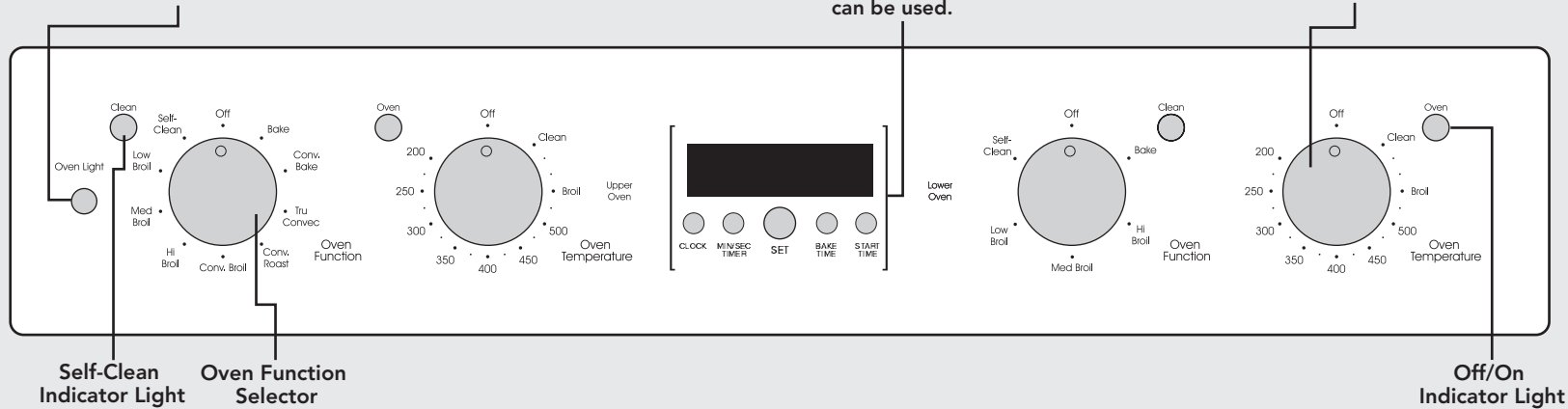

Product Controls

Product Controls

Oven Functions and Settings

Bake

Conventional, single-rack baking (breads, cakes, cookies, pastry, pies, entrees, vegetables)

Conv Bake (Convection Bake)

Multi-rack baking for heavier or frozen foods (e.g., four frozen pies, pizzas, entrees, vegetables)

TruConvect™

Multi-rack baking for breads, cakes, cookies (up to six racks of cookies at once)

Conv Roast (Convection Roast)

Whole turkeys, whole chickens, hams, etc.

Conv Broil (Convection Broil)

Thicker meats, faster than regular broil, and with less smoke generation

High-Broil

Dark meats at 1" thickness or less where rare or medium doneness is desired

Medium-Broil

White meats such as chicken or meats greater than 1" thick that would be over-browned in high broil

Low-Broil

Delicate broiling such as meringue

Conv Dehydrate (Convection Dehydrate)

Use this setting to dehydrate fruits and vegetables

Conv Defrost (Convection Defrost)

Use this setting to defrost foods

Self-Clean

A pyrolytic self-cleaning cycle where the oven reaches elevated temperatures in order to burn off soils and deposits

*The DDOE301 model control panel is shown above.

Oven Features

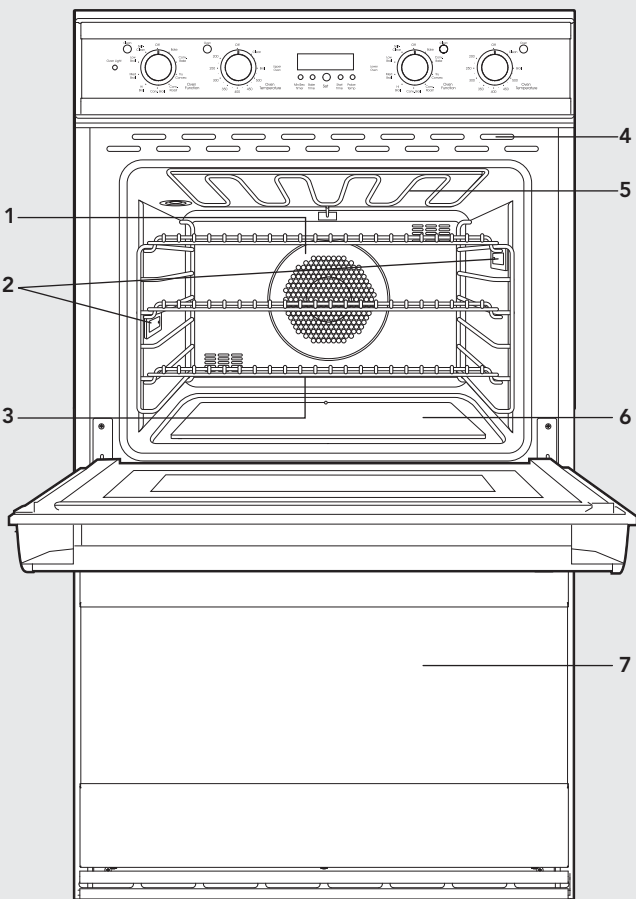

- 1. TruConvec™ element (behind baffle)
- 2. Oven light
- 3. Oven racks (three upper, three lower)
- 4. Model/Serial number plate (behind vents)
- 5. Broil element
- 6. Bake element
- 7. Lower oven

Clocks and Timers

Electronic Timing Center

The Electronic Timing Center is used to program and control all timing functions. It has five display and programming modes that are activated by the four push buttons and the "SET" knob. Both the BAKE TIME mode and the MIN/SEC TIMER

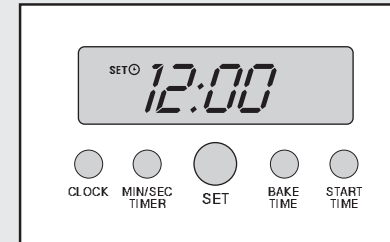

mode can be used to time cooking periods. These features can even be used at the same time when both ovens are in use. However, only BAKE TIME and Self-Cleaning modes shut the oven off automatically when the timed program is over. For example, you can time bake a casserole in the upper oven using the BAKE TIME mode, while broiling in the lower oven using the MIN/SEC TIMER. One oven can also be cleaned while timing foods in the other oven using the MIN/SEC TIMER.

Setting the Min/Sec Timer

The MIN/SEC TIMER is designed for accurate timing and is ideal for baking delicate items such as biscuits, cookies, and popovers, and for precise broiling. The MIN/SEC TIMER can be used at the same time the BAKE TIME or START TIME functions are in use. It can be used for timing up to 24 hours. When setting the timer, the time displayed will increase in 1 minute increments. When the timer counts down to 1 minute, the timer alarm will give two short beeps and the display changes from hours:minutes to seconds only.

To program the Min/Sec Timer

1. Press the "MIN/SEC TIMER" button. The timer will display :00 and the word TIMER will be displayed in the lower right corner.
2. Turn the "SET" knob until the desired duration time is displayed.

The MIN/SEC TIMER is now programmed. The alarm will sound at the end of the countdown. The program can be canceled anytime by setting the remaining time to :00. To change back to the time-of-day, press the "CLOCK" button. Notice that a small clock will be displayed in the upper right corner to indicate that a program is in progress. The display will return automatically to the MIN/SEC TIMER after a few seconds.

Clocks and Timers

Timer Alarm

At the end of a MIN/SEC TIMER program or BAKE TIME program, the alarm will consist of three beeps followed by two beeps every 10 seconds until the "MIN/SEC TIMER" button is pressed. Whenever a valid function key is pressed or when a control function starts automatically, one beep will be sounded. When an invalid function key is pressed, two beeps will be sounded.

Setting the Automatic Start Time Bake Program (Not available in lower oven of DDOE301 Models)

The BAKE TIME and START TIME modes of the timer can be used to automatically turn the oven on and off at a preselected time. The Automatic Time Bake program is ideal for foods with no danger of spoilage during the time the oven is left off.

To Set The Automatic Time Bake Program:

1. Set the start time:

A) For Single Ovens – Program the start time by pressing the "START TIME" button and turning the "SET" knob until the desired start time is displayed. This is the time of day you want the food to begin cooking.

B) For Double Ovens – Press the "START TIME" button once to set the starting time for the upper oven (UPPER OVEN will show on the display). Press the "START TIME" button twice to set the starting time for the lower oven (LOWER OVEN will show on the display). Then program the start time by turning the "SET" knob until the desired start time is displayed. This is the time of day you want the food to begin cooking.

2. Set the desired baking time:

Once the start time is set, the display will switch to :00 and the words SET, COOK and TIME will appear on the right side of the display. You will now enter the desired baking time. Turn the "SET" knob until the desired baking time is displayed in hours and minutes. Once the desired bake time is set, the word SET will disappear and the word DELAY will appear in the display indicating that the Bake Hours program has been set.

Note: For double ovens, the word DELAY will show with either UPPER OVEN or LOWER OVEN depending on which oven has been selected.

Note: For delayed Time Bake, the oven will automatically add 30 minutes to the programmed cooking time to account for preheat.

Clocks and Timers

To Set The Automatic Time Bake Program: (cont.)

3. **Set the Oven Function selector** to the desired function – BAKE, CONVECTION BAKE, or TRUCONVEC™, etc.

4. **Set the temperature control knob to the desired baking temperature.**

5. The Automatic Time Bake program is now set.

Note: The display will continue to show the amount of bake time that was programmed (this will remain until the programmed start time is reached). You can return the display to clock mode by pressing the "CLOCK" button. Notice that a small clock will be displayed in the upper right corner to indicate that a program is in progress. Switch back to the timer mode by pressing the "BAKE TIME" button.

6. When the specified time is reached, the oven will automatically turn on. It will bake for the programmed amount of time at the selected temperature.

Note: At 1 minute from the end of the specified bake program, the oven timer will beep once. At the end of the specified bake program, the oven will automatically turn off and the timer will sound a series of three beeps. This will continue until the "START TIME" button is pressed. The display will then return to displaying the time.

Note: Setting the remaining duration time to :00 will cancel the Automatic Bake program.

Functions and Settings

These functions allow you to customize the oven controls to suit your specific tastes. The following oven settings are available:

Degree Format

The oven has been preset to the Fahrenheit temperature scale. With this feature, users can switch to the Celsius temperature scale.

Clock Format

This feature allows users to choose a 12-hour or 24-hour format for the clock display.

Sabbath Mode

This mode offers users belonging to religions with “no work” restrictions to program their ovens to comply with the Sabbath requirement. When the oven door is opened in Sabbath mode, the oven light stays off while the convection fan and heating elements remain on.

Showroom Mode (Not recommended to be used by the consumer)

This mode allows the oven to be hooked up to a 120 volt electrical supply for display or showroom made purposes. In this mode, the electronic display/controls and oven lights will function but the heating elements and convection fan will NOT function.

Functions and Settings

To enter into the Oven Settings mode: (For DSOE301 and DDOE301 Models)

1. Press and hold the “CLOCK” button for 3 seconds.
2. Use the “SET” knob to scroll between the different Oven Settings.
3. To toggle between a specific Oven Setting, press the “CLOCK” button.

Note: Whatever Oven Setting is displayed while you toggle between settings is what will be active when you exit the Oven Settings feature.

4. To exit the Oven Settings mode, press the “MIN/SEC TIMER” button. The oven will automatically exit the Oven Settings mode if the “MIN/SEC TIMER” button is not pressed within 60 seconds.

To enter into the Oven Settings mode: (For DDOE305 Models)

1. Press and hold the “MIN/SEC TIMER” button for 3 seconds.
2. Use the “SET” knob to scroll between the different Oven Settings.
3. To toggle between a specific Oven Setting, press the “MIN/SEC TIMER” button.

Note: Whatever Oven Setting is displayed while you toggle between settings is what will be active when you exit the Oven Settings feature.

4. To exit the Oven Settings mode, press the “BAKE TIME” button. The oven will automatically exit the Oven Settings mode if the “BAKE TIME” button is not pressed within 60 seconds.

Using the Oven

Preheat

For best results, it is extremely important that you preheat your oven to the desired cooking temperature before placing food items in the oven to begin cooking. In many cooking modes, partial power from the broiler is used to bring the oven to the preheat temperature. Therefore, placing food items in the oven during preheat mode is not recommended. The Preheat System is engineered so that the oven is brought to the desired set temperature in a manner which will provide the optimum cooking environment based on the selected cooking mode in the shortest possible time.

Meat Probe Function

(305 models only)

The meat probe takes the guesswork out of roasting by cooking foods to the ideal internal temperature. The probe temperature setting is used to notify the user when the internal temperature of the meat being roasted is reached.

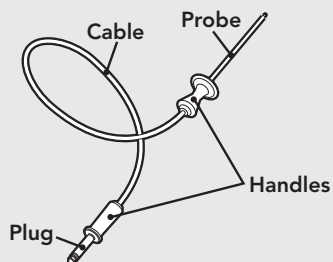

To Set the Automatic Probe Function

1. Insert probe into the meat and slide into oven.
2. Plug the probe into the outlet located on right interior wall of the oven and close oven door.
3. Select cooking function and set temperature.
4. Press the "PROBE TEMP" button.
5. Turn the "SET" knob to the desired internal temperature. The word PROBE and the desired internal temperature will be displayed on the lower right of the clock. On double ovens, the manual/timed control must be turned to "UPPER TIMED."

Note: It is recommended to set the internal temperature about 10 degrees lower than actual desired internal temperature. The meat will continue to cook when removed from the oven and will reach desired internal temperature while "standing".

The word PROBE flashes and tone sounds three times when desired temperature is reached. The tone will sound twice every 10 seconds after completion until probe function is closed.

Using the Oven

Rack Positions

Each oven is equipped with three tilt-proof racks. 305 model ovens have two standard tilt-proof racks and one TruGlide™ rack. With the TruGlide™ rack, the bottom section remains in the oven and the top section smoothly glides outward when pulled. This reduces the chances of spills from items that contain a lot of juice or liquid. This rack can be used in any of the six rack positions.

All ovens have five rack positions. Position 5 is the farthest from the oven bottom. Position 1 is the closest to the oven bottom. The racks can be easily removed and arranged at various levels. For best results with conventional baking, do not use more than one rack at a time. It is also recommended, when using two racks, to bake with the racks in positions 2 and 4 or positions 3 and 5.

1. Arrange the oven racks in the desired positions BEFORE heating the oven. If cooking on two racks at the same time, use rack positions 2 and 4 or positions 3 and 5.
2. Turn the Oven Function selector to desired function. Cooking starts immediately and stops when the Oven Function selector is turned to "OFF".
3. Set the Temperature Control to the desired temperature.
4. Place the food in the oven after the oven indicator light goes out.

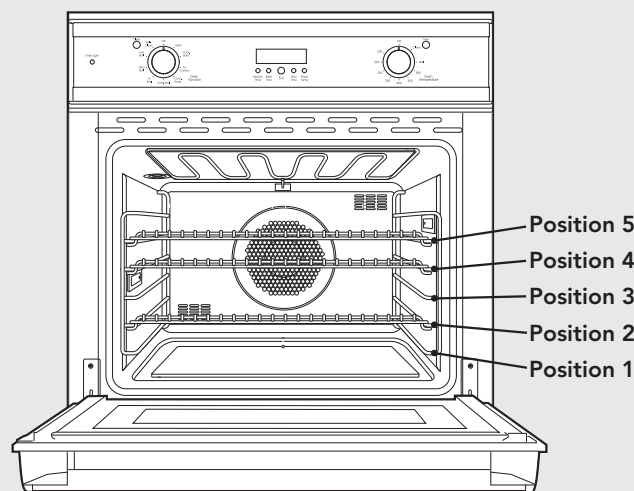

Using the Oven

Conventional and Convection Cooking

Because of variations in food density, surface texture and consistency, some foods may be prepared more successfully using the conventional bake setting. For this reason, conventional baking is recommended when preparing baked goods such as custard. The user may find other foods that are also prepared more consistently in conventional bake. This is perfectly normal. Convection cooking is a cooking technique which utilizes fan forced air to circulate heat throughout the entire oven creating the optimum cooking environment. Cooking with convection is intended when performing multi-rack baking and for baking heavier foods. Below are tips which will allow you to get the best results out of your oven when cooking with convection.

- As a general rule, to convert conventional recipes to convection recipes, reduce the temperature by 25°F (-3.9°C) and the cooking time by approximately 10 to 15%.
- Cooking times for standard baking and convection baking will be the same. However, if using convection to cook a single item or smaller load, then it is possible to have 10-15% reduction in cooking time. (Remember convection cooking is designed for multi-rack baking or cooking large loads.)
- If cooking items which require longer than 45 minutes, then it is possible to see a 10-15% reduction in cooking time. This is especially true for large items cooked in the convection roast function.
- A major benefit of convection cooking is the ability to prepare foods in quantity. The uniform air circulation makes this possible. Foods that can be prepared on two of three racks at the same time include: pizza, cakes, cookies, biscuits, muffins, rolls, and frozen convenience foods.
- For three-rack baking, use any combination of rack positions 2, 3, 4, and 5. For two-rack baking, use rack positions 2 and 4 or positions 3 and 5. Remember that the racks are numbered from bottom to top. See "Oven Features" section.
- Items cooked in a convection function can be easily over-baked. This being the case, it is usually a good idea to pull items out of the oven just before they seem to be done. Items will continue to cook right after they are set out of the oven.

Using the Oven

Conventional and Convection Cooking (cont.)

- Some recipes, especially those that are homemade, may require adjustment and testing when converting from standard to convection modes. If unsure how to convert a recipe, begin by preparing the recipe in conventional bake. After achieving acceptable results, follow the convection guidelines listed for the similar food type. If the food is not prepared to your satisfaction during this first convection trial, adjust only one recipe variable at a time (cooking time, rack position, or temperature) and repeat the convection test. Continue adjusting one recipe variable at a time until satisfactory results are achieved.

Using the Oven

Condensation

The oven is supplied with a system which provides a natural circulation of air. In most cases, this natural circulation will eliminate any observed condensation. However, there will be instances where condensation is observed. This is NOT a sign that the oven is not working properly.

Condensation can occur depending on the following factors:

- Type of food being cooked
 - Steam and condensation is a natural by product of cooking any food with high water content, such as frozen food, chicken, etc.
 - Use a covered container, where practical, when cooking to reduce the amount of condensation that forms.
- Length of cooking time
 - If the oven is going to be used for prolonged periods of time, then additional ventilation may be required.
 - Do not leave food in the oven to cool after it has been cooked and the oven has been switched off.
 - To reduce condensation, ensure the oven is well heated before placing food in the oven cavity.
- Blockage of the oven's air flow
 - If the oven air flow is changed, the oven will not perform to specification.
- Proper installation ventilation
 - The oven needs good ventilation within the installed cabinets to perform per specification.
- Type of cabinetry the oven is installed in
 - Cabinets need to meet specific temperature requirements.
 - Some cabinetry materials have high water contents that can outgas during the heating cycle.
- Ambient conditions in the kitchen including humidity and temperature

Using the Oven

Pan Placement Tips

- When using large (15" x 13") flat pans or trays that cover most of the rack, rack positions 2 or 3 produce the best results.
- When baking on more than one rack, it is recommended to use one of the convection modes and the 2nd and 4th position or the 3rd and 5th position for more even baking. When baking on three racks, use any combination of positions 2, 3, 4, and 5 for more consistent results.
- Stagger pans in opposite directions when two racks and several pans are used in conventional bake. If possible, no pan should be directly above another.
- Allow 1 to 2 inches of air space around all sides of each pan for even air circulation.

Single Rack Pan Placement

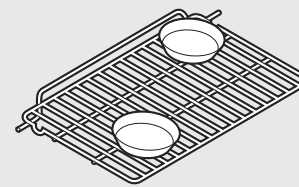

Multiple Rack Pan Placement

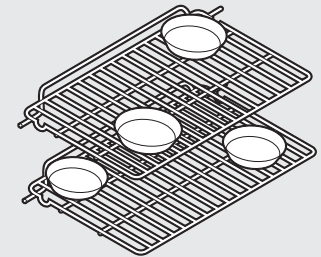

Baking

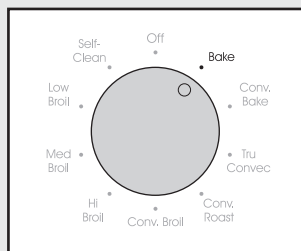

BAKE (Two-Element Bake)

Full power heat is radiated from the bake element in the bottom of the oven cavity and supplemental heat is radiated from the broil element. This function is recommended for single-rack baking. Many cookbooks contain recipes to be cooked in the conventional manner. Conventional baking/roasting is particularly suitable for dishes that

require a high temperature. Use this setting for baking, roasting, and casseroles.

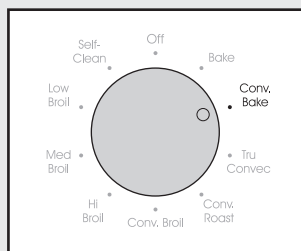

CONV BAKE (Convection Bake)

The bottom element operates at full power, and the top broil element operates at supplemental power. The heated air is circulated by the motorized fan in the rear of the oven providing a more even heat distribution. This even circulation of air equalizes the temperature throughout the oven cavity and eliminates the hot and cold spots

found in conventional ovens. A major benefit of convection baking is the ability to prepare food in quantity using multiple racks—a feature not possible in a standard oven.

When roasting using this setting, cool air is quickly replaced, searing meats on the outside and retaining more juices and natural flavor on the inside with less shrinkage. With this heating method, foods can be baked and roasted at the same time with minimal taste transfer, even when different dishes are involved, such as cakes, fish or meat. The hot air system is especially economical when thawing frozen food. Use this setting for baking and roasting.

Baking

TRU CONV (TruConvec™)

The rear element only operates at full power. There is no direct heat from the bottom or top elements. The motorized fan in the rear of the oven circulates air in the oven cavity for even heating. Use this setting for foods that require gentle cooking such as pastries, souffles, yeast breads, quick breads and cakes. Breads, cookies, and other baked goods come out evenly textured with golden crusts. No special bakeware is required. Use this function for single-rack baking, multiple-rack baking, roasting, and preparation of complete meals. This setting is also recommended when baking large quantities of baked goods at one time.

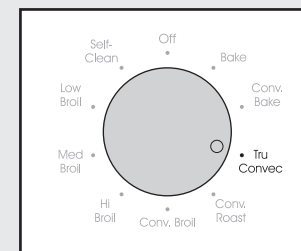

Baking Tips

- Make sure the oven racks are in the desired positions before you turn the oven on.
- **DO NOT** open the oven door frequently during baking. If you must open the door, the best time is during the last quarter of the baking time.
- Bake to shortest time suggested and check for doneness before adding more time. For baked goods, a stainless steel knife placed in the center of the food should come clean when done.
- Use the pan size and type recommended by the recipe to ensure best results. Cakes, quick breads, muffins, and cookies should be baked in shiny, reflective pans for light, golden crusts. Avoid the use of old, darkened pans. Warped, dented, stainless steel and tin-coated pans heat unevenly and will not give uniform baking results.

Baking

Baking Chart

Food	Pan Size	Single Rack Position	Temp	Time (min)
BREADS				
Biscuits	Cookie sheet	3 or 4	400° F (204.4° C)	8 - 10
Yeast loaf	Loaf pan	3 or 4	375° F (190.6° C)	30 - 35
Yeast rolls	Cookie sheet	3 or 4	400° F (204.4° C)	12 - 15
Nut bread	Loaf pan	3 or 4	375° F (190.6° C)	30 - 35
Cornbread	8" x 8"	3 or 4	400° F (204.4° C)	20 - 25
Gingerbread	8" x 8"	3 or 4	350° F (176.7° C)	35 - 40
Muffins	Muffin tin	3 or 4	375° F (190.6° C)	15 - 20
Corn muffins	Muffin tin	3 or 4	375° F (190.6° C)	15 - 20
CAKES				
Angel food	Tube pan	3 or 4	375° F (190.6° C)	35 - 45
Bundt	Tube pan	3 or 4	350° F (176.7° C)	45 - 55
Cupcakes	Muffin pan	3 or 4	350° F (176.7° C)	16 - 20
Layer, sheet	13" x 9"	3 or 4	350° F (176.7° C)	40 - 50
Layer, two	9" round	3 or 4	350° F (176.7° C)	30 - 35
Pound	Loaf pan	3 or 4	350° F (176.7° C)	60 - 65
COOKIES				
Brownies	13" x 9"	3 or 4	350° F (176.7° C)	25 - 30
Choc. chip	Cookie sheet	3 or 4	375° F (190.6° C)	12 - 15
Sugar	Cookie sheet	3 or 4	350° F (176.7° C)	10 - 12
PASTRY				
Cream puffs	Cookie sheet	3 or 4	400° F (204.4° C)	30 - 35
PIES				
Crust, unfilled	9" round	3 or 4	425° F (218.3° C)	10 - 12
Crust, filled	9" round	3 or 4	375° F (190.6° C)	55 - 60
Lemon meringue	9" round	3 or 4	350° F (176.7° C)	12 - 15
Pumpkin	9" round	3 or 4	350° F (176.7° C)	40 - 45
Custard	6 - 4 oz cups	3 or 4	350° F (176.7° C)	35 - 40
ENTREES				
Egg rolls	Cookie sheet	3 or 4	400° F (204.4° C)	12 - 15
Fish sticks	Cookie sheet	3 or 4	425° F (218.3° C)	18 - 21
Lasagna, frz	Cookie sheet	3 or 4	375° F (190.6° C)	65 - 70
Pot pie	Cookie sheet	3 or 4	400° F (204.4° C)	35 - 40
Gr. peppers stuffed	13" x 9"	3 or 4	375° F (190.6° C)	65 - 70
Quiche	9" round	3 or 4	400° F (204.4° C)	25 - 30
Pizza, 12"	Cookie sheet	3 or 4	400° F (204.4° C)	15 - 20
Mac. & cheese, frz	Cookie sheet	3 or 4	375° F (190.6° C)	60 - 65
VEGETABLES				
Baked potatoes	On rack	3 or 4	375° F (190.6° C)	60 - 65
Spinach souffle	1 qt. casserole	3 or 4	350° F (176.7° C)	45 - 50
Squash	Cookie sheet	3 or 4	375° F (190.6° C)	50 - 55
French fries	Cookie sheet	3 or 4	425° F (218.3° C)	15 - 20

Baking

Convection Baking Chart

Food	Pan Size	Single Rack Position	Temp	Time (min)
BREADS				
Biscuits	Cookie sheet	2 & 4	375° F (190.6° C)	7 - 9
Yeast loaf	Loaf pan	2 & 4	350° F (176.7° C)	20 - 25
Yeast rolls	Cookie sheet	2 & 4	375° F (190.6° C)	11 - 13
Nut bread	Loaf pan	2 & 4	350° F (176.7° C)	20 - 25
Cornbread	8" x 8"	2 & 4	375° F (190.6° C)	15 - 20
Gingerbread	8" x 8"	2 & 4	325° F (162.8° C)	30 - 35
Muffins	Muffin tin	2 & 4	350° F (176.7° C)	12 - 15
Corn muffins	Muffin tin	2 & 4	350° F (176.7° C)	0 - 12
CAKES				
Angel food	Tube pan	3 or 4	325° F (162.8° C)	30 - 35
Bundt	Tube pan	3 or 4	325° F (162.8° C)	35 - 40
Cupcakes	Muffin pan	2 & 4	325° F (162.8° C)	15 - 17
Layer, sheet	13" x 9"	2 & 4	325° F (162.8° C)	30 - 32
Layer, two	9" round	2 & 4	325° F (162.8° C)	25 - 30
Pound	Loaf pan	2 & 4	325° F (162.8° C)	5 - 50
COOKIES				
Brownies	13" x 9"	2 & 4	325° F (162.8° C)	20 - 25
Choc. chip	Cookie sheet	2,3,& 4	350° F (176.7° C)	7 - 10
Sugar	Cookie sheet	2,3,& 4	325° F (162.8° C)	9-10
PASTRY				
Cream puffs	Cookie sheet	2 & 4	375° F (190.6° C)	4 - 27
PIES				
Crust, unfilled	9" round	2 & 4	400° F (204.4° C)	7 - 9
Crust, filled	9" round	2 & 4	350° F (176.7° C)	50 - 55
Lemon meringue	9" round	2 & 4	325° F (162.8° C)	4 - 5
Pumpkin	9" round	2 & 4	325° F (162.8° C)	35 - 45
Custard	6 - 4oz cups	2 & 4	325° F (162.8° C)	30 - 35
ENTREES				
Egg rolls	Cookie sheet	2 & 4	375° F (190.6° C)	8 - 10
Fish sticks	Cookie sheet	2 & 4	400° F (204.4° C)	13 - 16
Lasagna, frz	Cookie sheet	2 & 4	350° F (176.7° C)	60 - 65
Pot pie	Cookie sheet	2 & 4	375° F (190.6° C)	10 - 12
Gr. peppers stuffed	13" x 9"	2 & 4	350° F (176.7° C)	45 - 50
Quiche	9" round	2 & 4	375° F (190.6° C)	20 - 25
Pizza, 12"	Cookie sheet	2 & 4	375° F (190.6° C)	10 - 12
Mac. & cheese, frz	Cookie sheet	3 or 4	350° F (176.7° C)	45 - 50
VEGETABLES				
Baked potatoes	On rack	3 or 4	350° F (176.7° C)	45 - 50
Spinach souffle	1 qt. casserole	3 or 4	325° F (162.8° C)	35 - 40
Squash	Cookie sheet	3 or 4	350° F (176.7° C)	40 - 45
French fries	Cookie sheet	3 or 4	400° F (204.4° C)	10 - 15



Solving Baking Problems

Baking problems can occur for many reasons. Check the chart below for the causes and remedies for the most common problems. It is important to remember that the temperature setting and cooking times you are accustomed to using with your previous oven may vary slightly from those required with this oven. If you find this to be true, it is necessary for you to adjust your recipes and cooking times accordingly.

Common Baking Problems/Remedies

Problems	Cause	Remedy
Cakes burned on the sides or not done in center	<ol style="list-style-type: none"> Oven was too hot Wrong pan size Too many pans 	<ol style="list-style-type: none"> Reduce temperature Use recom. pan size Reduce no. of pans
Cakes crack on top	<ol style="list-style-type: none"> Batter too thick Oven too hot Wrong pan size 	<ol style="list-style-type: none"> Follow recipe Add liquid Reduce temperature Use recom. pan size
Cakes are not level	<ol style="list-style-type: none"> Batter uneven Oven or rack not level Pan was warped 	<ol style="list-style-type: none"> Distribute batter even Level oven or rack Use proper pan
Food too brown on bottom	<ol style="list-style-type: none"> Oven door opened too often Dark pans being used Incorrect rack position Wrong bake setting Pan too large 	<ol style="list-style-type: none"> Use door window to check food Use shiny pans Use recom. rack position Adjust to conventional or convection setting as needed Use proper pan
Food too brown on top	<ol style="list-style-type: none"> Rack position too high Oven not preheated Sides of pan too high 	<ol style="list-style-type: none"> Use recom. rack position Allow oven to preheat Use proper pans
Cookies too flat	<ol style="list-style-type: none"> Hot cookie sheet 	<ol style="list-style-type: none"> Allow sheet to cool between batches
Pies burned around edges	<ol style="list-style-type: none"> Oven too hot Too many pans used Oven not preheated 	<ol style="list-style-type: none"> Reduce temperature Reduce no. of pans Allow oven to preheat
Pies too light on top	<ol style="list-style-type: none"> Oven not hot enough Too many pans used Oven not preheated 	<ol style="list-style-type: none"> Increase temperature Reduce no. of pans Allow oven to preheat

Roasting

CONV ROAST* (Convection Roast)

The convection element runs in conjunction with the inner and outer broil elements. This transfer of heat (mainly from the convection element) seals moisture inside large roasts. Use this setting for whole turkeys, whole chickens, hams, etc.

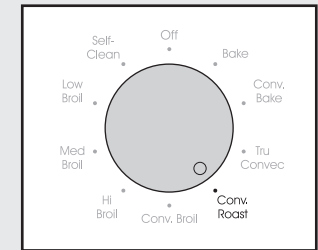

Note: You can also roast foods using bake settings. See the "Baking" section for additional information.

Roasting Tips

ALWAYS use the broiler pan and grid supplied with each oven. The hot air must be allowed to circulate around the item being roasted. **DO NOT** cover what is being roasted. Convection roasting seals in juices quickly for a moist, tender product. Poultry will have a light, crispy skin and meats will be browned, not dry or burned. Cook meats and poultry directly from the refrigerator. There is no need for meat or poultry to stand at room temperature.

- As a general rule, to convert conventional recipes to convection recipes, reduce the temperature by 25°F (-3.9°C) and the cooking time by approximately 10 to 15%.
- ALWAYS** roast meats fat side up in a shallow pan using a roasting rack. No basting is required when the fat side is up. **DO NOT** add water to the pan as this will cause a steamed effect. Roasting is a dry heat process.
- Poultry should be placed breast side up on a rack in a shallow pan. Brush poultry with melted butter, margarine, or oil before and during roasting.
- For convection roasting, **DO NOT** use pans with tall sides as this will interfere with the circulation of heated air over the food.
- If using a cooking bag, foil tent, or other cover, use the conventional bake setting rather than either convection setting.

Roasting

Roasting Tips (cont.)

- When using a meat thermometer, insert the probe halfway into the center of the thickest portion of the meat. (For poultry, insert the thermometer probe between the body and leg into the thickest part of the inner thigh.) The tip of the probe should not touch bone, fat, or gristle to ensure an accurate reading. Check the meat temperature halfway through the recommended roasting time. After reading the thermometer once, insert it 1/2 inch (1.3 cm) further into the meat, then take a second reading. If the second temperature registers below the first, continue cooking the meat.
- Roasting times **ALWAYS** vary according to the size, shape and quality of meats and poultry. Less tender cuts of meat are best prepared in the conventional bake setting and may require moist cooking techniques. Remove roasted meats from the oven when the thermometer registers 5°F (-15°C) to 10°F (-12°C) lower than the desired doneness. The meat will continue to cook after removal from the oven. Allow roasts to stand 15 to 20 minutes after roasting in order to make carving easier.

For many foods, especially roasts and poultry, internal food temperature is the best test for doneness. The meat probe takes the guesswork out of roasting by cooking foods to the exact doneness you want.

Note: Double oven models have a probe in the upper oven only.

Use of probes other than the one provided with this product may result in damage to the probe. Use the handles of the probe and plug when inserting and removing them from the meat and outlet.

- To avoid damaging your probe, **DO NOT** use tongs to pull on the cable when removing.
- To avoid breaking the probe, make sure food is completely defrosted before inserting.
- To prevent possible burns, **DO NOT** unplug the probe from the outlet until the oven has cooled.
- **NEVER** leave the probe inside the oven during a self-cleaning cycle.
- **DO NOT** store the probe in the oven.

Roasting

Roasting Tips (cont.)

After preparing the meat and placing on broiler pan, follow these steps for proper probe placement.

- Lay the probe on the outside of the meat along the top or side and mark with your finger where the edge of the meat comes to on the probe. The point should rest in the center of the thickest meaty part of the roast.
- Insert the probe completely into the meat. It should not touch the bone, fat, or gristle. For roasts with no bone, insert the probe into the meatiest part of the roast. For bone-in ham or lamb, insert the probe into the center of the lowest large muscle or joint. Insert the probe into the meatiest part of the inner thigh from below and parallel to the leg of a whole turkey.
- When setting the probe temperature, it is recommended to set the temperature about 10°F (4°C) lower than desired internal temperature. The meat will continue to cook when removed from the oven and will reach the desired doneness while “standing”.

Roasting

Conventional Roasting Chart
(when using the Bake or Convection Bake setting)

Food	Weight	Temp	Time (min/lb)	Internal Temp
BEEF				
Rib roast				
Rare	4 - 6 lbs	325° F (162.8° C)	25	140° F (60.0° C)
Medium	4 - 6 lbs	325° F (162.8° C)	30	155° F (68.3° C)
Well done	4 - 6 lbs	325° F (162.8° C)	40	170° F (76.7° C)
Rump roast				
Medium	4 - 6 lbs	325° F (162.8° C)	25	155° F (68.3° C)
Well done	4 - 6 lbs	325° F (162.8° C)	30	170° F (76.7° C)
Tip roast				
Medium	3 - 4 lbs	325° F (162.8° C)	35	155° F (68.3° C)
Well done	3 - 4 lbs	325° F (162.8° C)	40	170° F (76.7° C)
LAMB				
Lamb leg	3 - 5 lbs	325° F (162.8° C)	30	180° F (82.2° C)
PORK				
Pork loin	3 - 5 lbs	325° F (162.8° C)	35	180° F (82.2° C)
Pork chops 1" thick	1 - 1 1/4 lbs	350° F (176.7° C)	55 - 60 total time	N/A
Ham, fully cooked	5 lbs	325° F (162.8° C)	18	130° F (54.4° C)
POULTRY				
Chicken, whole	3 - 4 lbs	375° F (190.6° C)	30	180° F (82.2° C)
Turkey, unstuffed	12 - 16 lbs	325° F (162.8° C)	16 - 20	180° F (82.2° C)
Turkey	20 - 24 lbs	325° F (162.8° C)	16 - 20	180° F (82.2° C)
Turkey, stuffed	12 - 16 lbs	325° F (162.8° C)	17 - 21	180° F (82.2° C)
Turkey, stuffed	20 - 24 lbs	325° F (162.8° C)	17 - 21	180° F (82.2° C)
Turkey breast	4 - 6 lbs	325° F (162.8° C)	20	180° F (82.2° C)

Note: The above information is given as a guide only.

Roasting

Convection Roasting Chart

Food	Weight	Temp	Time (min/lb)	Internal Temp
BEEF				
Rib roast				
Rare	4 - 6 lbs	325° F (162.8° C)	25	140° F (60.0° C)
Medium	4 - 6 lbs	325° F (162.8° C)	24	155° F (68.3° C)
Well done	4 - 6 lbs	325° F (162.8° C)	30	170° F (76.7° C)
Rump roast				
Medium	4 - 6 lbs	325° F (162.8° C)	20	155° F (68.3° C)
Well done	4 - 6 lbs	325° F (162.8° C)	24	170° F (76.7° C)
Tip roast				
Medium	3 - 4 lbs	325° F (162.8° C)	30	155° F (68.3° C)
Well done	3 - 4 lbs	325° F (162.8° C)	35	170° F (76.7° C)
LAMB				
Lamb leg	3 - 5 lbs	325° F (162.8° C)	30	180° F (82.2° C)
PORK				
Pork loin	3 - 5 lbs	325° F (162.8° C)	30	180° F (82.2° C)
Pork chops 1" thick	1 - 1 1/4 lbs	325° F (162.8° C)	45 - 50 total time	N/A
Ham, fully cooked	5 lbs	325° F (162.8° C)	15	130° F (54.4° C)
POULTRY				
Chicken, whole	3-4 lbs	350 (176.7 C)	25	180° F (82.2° C)
Turkey, unstuffed	12 - 16 lbs	325° F (162.8° C)	11	180° F (82.2° C)
Turkey	20 - 24 lbs	325° F (162.8° C)	11	180° F (82.2° C)
Turkey, stuffed	12 - 16 lbs	325° F (162.8° C)	9 - 10	180° F (82.2° C)
Turkey, stuffed	20 - 24 lbs	325° F (162.8° C)	9 - 10	180° F (82.2° C)
Turkey breast	4 - 6 lbs	325° F (162.8° C)	20	180° F (82.2° C)

Note: The above information is given as a guide only.

Broiling

CONV BROIL* (Convection Broil)

The top element operates at full power. This function is exactly the same as regular broiling with the additional benefit of air circulation by the motorized fan in the rear of the oven. Smoke is reduced since the airflow also reduces peak temperatures on the food. Use this setting for broiling thick cuts of meats.

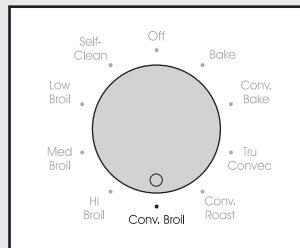

HI BROIL

Heat radiates from both broil elements, located in the top of the oven cavity, at full power. The distance between the foods and the broil elements determines broiling speed. For fast broiling, food may be as close as 2 inches (5 cm) to the broil element or on the top rack. Fast broiling is best for meats where rare to medium doneness is desired. Use this setting for broiling small and average cuts of meat.

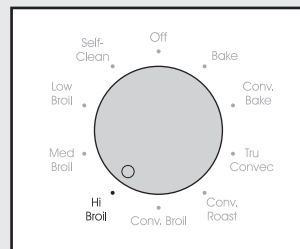

MED BROIL

Inner and outer broil elements pulse on and off to produce less heat for slow broiling. Allow about 4 inches (10 cm) between the top surface of the food and the broil element. Slow broiling is best for chicken and ham in order to broil food without over-browning it. Use this setting for broiling small and average cuts of meat.

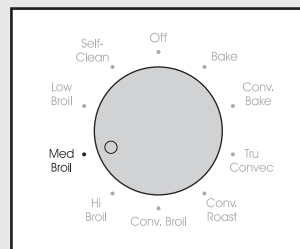

Broiling

LOW BROIL

This mode uses only a fraction of the available power to the inner broil element for delicate top-browning. The inner broil element is on for only part of the time. Use this setting to gently brown meringue on racks 3 or 4 in 3-4 minutes.

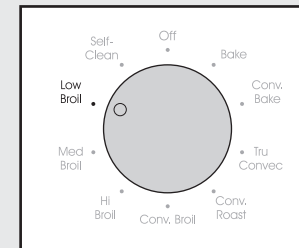

Broiling Instructions

Broiling is a dry-heat cooking method using direct or radiant heat. It is used for small, individualized cuts such as steaks, chops, and patties. Broiling speed is determined by the distance between the food and the broil element. Choose the rack position based on desired results.

Conventional broiling (LOW, MED or HI BROIL) is most successful for cuts of meat 1-2 inches thick and is also more suitable for flat pieces of meat. Convection broiling has the advantage of broiling food slightly quicker than conventional. Convection broiling of meats produces better results, especially for thick cuts. The meat sears on the outside and retains more juices and natural flavor inside with less shrinkage.

To Use Broil or Convection Broil

1. Arrange the oven rack in the desired position before turning broiler on.
2. Center the food on cold broiler pan and grid supplied with your oven. Place broiler pan in oven.
3. Set the oven function selector to desired broiling function and the temperature control knob to "BROIL".
4. Close the door. There is not a detent to hold the door in the open broil stop position. With open-door broiling, the broil element does not cycle on and off. With closed-door broiling, the broil element might cycle on and off if an extended broiling time is required. A built-in smoke "eliminator" in the top of the oven helps reduce smoke and odors.

Broiling

Broiling Chart

Type and Cut of Meat	Weight	Setting	Rack	Time (min)
BEEF				
Sirloin, 1"				
Rare	14 oz	Hi Broil	5 or 6	8-10
Medium	14 oz	Hi Broil	5 or 6	10-12
Well done	14 oz	Hi Broil	5 or 6	11-13
T-Bone, 3/4"				
Rare	10 oz	Hi Broil	5 or 6	7-8
Medium	10 oz	Hi Broil	5 or 6	9-10
Well done	10 oz	Hi Broil	5 or 6	11-12
Hamburger, 1/2"				
Rare	1/4 lb.	Hi Broil	5 or 6	6-7
Medium	1/4 lb.	Hi Broil	5 or 6	7-8
Well done	1/4 lb.	Hi Broil	5 or 6	8-9
CHICKEN				
Bnls breast 1"	1/2 lb.	Med-Broil	5 or 6	15-20
Bnls breast 1"	1/2 lb.	Convection Broil	4 or 5	15-20
Bones in Breast	2 -3 lbs. total	Med Broil	3 or 4	40-45
Bones in Breast	2 -3 lbs. total	Convection Broil	3 or 4	25-30
Chicken pieces	2 -3 lbs. total	Med Broil	3 or 4	40-45
Chicken pieces	2 -3 lbs. total	Convection Broil	3	25-30
HAM				
Ham slice, 1"	1 lb.	Med Broil	5 or 6	22
LAMB				
Rib chops, 1"	12 oz.	Convection Broil	4 or 5	7
Shoulder	1 lb.	Convection Broil	4 or 5	6
PORK				
Loin chops, 3/4"	1 lb.	Convection Broil	4	14
Bacon		Med Broil	5	6
FISH				
Salmon steak	1 lb.	Med Broil	4	7
Filletts	1 lb.	Med Broil	4 or 5	6

Note: The above information is given as a guide only.

Broiling

Broiling Tips

- **ALWAYS** use a broiler pan and grid for broiling. They are designed to provide drainage of excess liquid and fat away from the cooking surface to help prevent splatter, smoke, and fire.
- To keep meat from curling, slit fatty edge.
- Brush chicken and fish with butter several times as they broil to prevent drying out. To prevent sticking, lightly grease broiler tray.
- Broil on first side for slightly more than half the recommended time, season, and turn. Season second side just before removing.
- **ALWAYS** pull rack out to stop position before turning or removing food.
- Use tongs or a spatula to turn meats. **NEVER** pierce meat with a fork, as this allows the juices to escape.
- Remove the broiler pan from the oven when you remove the food. Drippings will bake onto the pan if it is left in the heated oven after broiling. While pan is hot, place damp paper towel over grid. Drizzle with liquid dishwashing detergent and pour water over grid. This will make cleaning of the pan easier, or the broiler pan can be lined with aluminum foil to make cleaning easier. Be sure the foil extends up the side of the pan. Although it is not recommended, the grid can also be covered with foil. Be sure to slit openings to conform with the openings in the grid so melted fat can drain through to prevent spattering, smoking, or the possibility of grease fire.



Convection Dehydrate/Defrost

Convection Dehydrate

This oven is designed not only to cook, but also to dehydrate fruits and vegetables.

1. Prepare the food as recommended.
2. Arrange the food on drying racks (not included with the oven; contact a local store handling speciality cooking utensils).
3. Set the appropriate low temperature and turn the selector to "TRU CONV".

⚠ CAUTION

You must carefully check the food during the dehydration process to ensure that it does not catch fire.

Convection Defrost

1. Place the frozen food on a baking sheet.
2. Set the temperature control to "OFF".
3. Turn the selector to "TRU CONV".

⚠ WARNING

To avoid sickness and food waste, **DO NOT** allow defrosted food to remain in the oven for more than 2 hours.

⚠ NOTICE

DO NOT turn the Temperature Control on during defrosting. Turning the convection fan on will accelerate the natural defrosting of the food without the heat.

Cleaning and Maintenance

Any piece of equipment works better and lasts longer when maintained properly and kept clean. Cooking equipment is no exception. Your oven must be kept clean and maintained properly.

Oven Surfaces

Several different finishes have been used in your electric oven. Cleaning instructions for each surface are given below. Your oven features a Self-Clean cycle for the oven interior. See "Self-Clean Cycle" for complete instructions. **NEVER** USE AMMONIA, STEEL WOOL PADS OR ABRASIVE CLOTHS, CLEANSERS, OVEN CLEANERS, OR ABRASIVE POWDERS. THEY CAN PERMANENTLY DAMAGE YOUR OVEN.

Control Knobs

MAKE SURE ALL THE CONTROL KNOBS POINT TO THE OFF POSITION BEFORE REMOVING. Pull the knobs straight off. Wash in detergent and warm water. Dry completely and replace by pushing firmly onto stem.

Stainless Steel Parts

Some stainless steel parts may have a protective wrap, which must be peeled off. All stainless steel body parts should be wiped regularly with hot, soapy water at the end of each cooling period and with liquid cleaner designed for this material when soapy water will not do the job. If build-up occurs, **DO NOT** use steel wool, or abrasive cloths, cleaners, or powders. If it is necessary to scrape stainless steel surface to remove encrusted material, soak area with hot, wet towels to loosen the material, then use a wooden or nylon spatula or scraper. **DO NOT** use a metal knife, spatula, or any other metal tool to scrape stainless steel surfaces. Scratches are almost impossible to remove.

Brass Parts

⚠ CAUTION

All special ordered brass parts are coated with an epoxy coating. **DO NOT** USE BRASS CLEANERS OR ABRASIVE CLEANERS ON ANY BRASS PARTS. All brass body parts should be wiped regularly with hot, soapy water. When hot, soapy water will not do the job, use everyday household cleaners that are not abrasive.

Cleaning and Maintenance

Broiler Pan and Grid

Clean with detergent and hot water. For stubborn spots, use a soap-filled steel wool pad.

Oven Racks

Clean with detergent and hot water. Stubborn spots can be scoured with a soap-filled steel wool pad. **DO NOT CLEAN THE OVEN RACKS OR RACK SUPPORT USING THE SELF-CLEAN CYCLE.** They could sustain damage due to the extreme heat of the Self-Clean cycle.

Meat Probe (305 models only)

The meat probe may be cleaned with soap and water or a soap-filled scouring pad. Cool the probe before cleaning. Scour stubborn spots with a soap-filled scouring pad, rinse and dry.

- **DO NOT** immerse the meat probe in water.
- **DO NOT** store the probe in the oven.

Self-Clean Cycle

This oven features an automatic pyrolytic self-cleaning cycle. During this cycle, the oven reaches elevated temperatures in order to burn off soil and deposits. An integral smoke eliminator helps reduce odors associated with the soil burn off. A powder ash residue is left in the bottom of the oven after completion of the self-clean cycle. The door latch is automatically activated after selecting the self-clean setting. The latch ensures that the door cannot be opened while the oven interior is at clean temperatures.

Before starting the Self-Clean cycle:

1. Remove the oven racks, and any other items/utensils from the oven. The high heat generated during the cleaning cycle can discolor, warp, and damage these items. **DO NOT** use foil or liners in the oven. During the self-clean cycle, foil can burn or melt and damage the oven surface.
2. Wipe off any large spills from the oven bottom and sides. **NEVER** use oven cleaners inside a self-cleaning oven or on raised portions of the door.
3. Some areas of the oven must be cleaned by hand before the cycle begins. Soils in these areas will be baked on and very difficult to clean if not removed first. Clean the door up to the gasket, the door frame, and up to 2" (5.1 cm) inside the frame with detergent and hot water. Rinse thoroughly and dry.

WARNING

BURN OR ELECTRICAL SHOCK HAZARD

Make sure all controls are "OFF" and oven is COOL before cleaning. Failure to do so can result in burns or electrical shock.

CAUTION

DO NOT touch the exterior portions of the oven after self-cleaning cycle has begun, since some parts become extremely hot to the touch! During the first few times the self-cleaning feature is used, there may be some odor and smoking from the curing of the binder in the high-density insulation used in the oven. When the insulation is thoroughly cured, this odor will disappear. During subsequent self-cleaning cycles, you may sense an odor characteristic of high temperatures. Keep the kitchen well-vented during the self-cleaning cycle.

Self-Clean Cycle

To start the Self-Clean cycle:

1. Close the door completely.
2. Turn the oven selector knob clockwise to the "SELF CLEAN" mode.
3. Turn the temperature control knob past the clean setting until the knob stops. At this time, the clean indicator light will come on. Within 30 seconds, the automatic door latch engages and the oven indicator light comes on. The oven indicator light will remain ON until the oven reaches the self-clean temperature and will then cycle on and off during the self-clean cycle. When the oven reaches the elevated temperature needed for self-clean, the door-lock indicator light comes on.
4. The door-lock indicator light will remain on until the self-clean is completed or interrupted and the oven temperature drops to a safe temperature. A complete cycle is approximately 3-1/2 hours with an additional 30 minutes needed for the oven to cool down enough for the door latch to disengage.

Note: A fan noise will be heard during the self-clean cycle and will continue to run for the 3-1/2 hour duration of the self-clean cycle.

5. When the cycle is completed, turn both the oven selector and temperature control knob to the "OFF" position. When the oven has completely cooled, open door and remove any ash from the oven surfaces with a damp cloth.

To stop the Self-Clean cycle:

To cancel or interrupt the self-cleaning cycle, turn both the temperature control knob and the oven function selector knob to "OFF". When the oven temperature drops to a safe temperature, the automatic door latch will release and the oven door can be opened. When the oven has completely cooled, remove any ash from the oven surfaces with a damp sponge or cloth.

Replacing Oven Lights

⚠ WARNING



ELECTRICAL SHOCK HAZARD

Disconnect the electric power at the main fuse or circuit breaker before replacing bulb.

⚠ WARNING

DO NOT touch bulb with bare hands. Clean off any signs of oil from the bulb and handle with a soft cloth.

Halogen Lights

1. Unsnap glass light cover using a screwdriver in the access groove.
2. Firmly grasp light bulb and pull out.
3. Replace with halogen bulb using volt and wattage requirements listed on glass cover.
4. Replace the light cover by snapping glass cover onto metal box.
5. Reconnect power at the main fuse or circuit breaker.

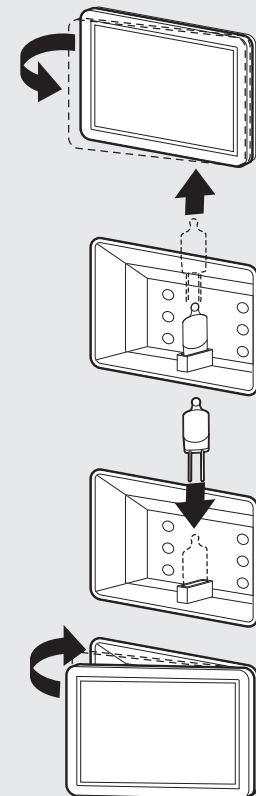

Power Failure

DO NOT attempt to use during a power failure. Unit will not function.

Troubleshooting

Problem	Possible Cause and/or Remedy
Oven will not function.	Oven is not connected to electrical power. Have electrician check power circuit breaker, wiring and fuses..
Oven does not operate in self-clean cycle.	Door is not shut tight enough for automatic door latch to lock.
Oven is not clean after self-clean cycle.	Temperature control knob not rotated all the way past clean until it stops.
Broil does not work.	Temperature control knob is rotated too far past broil position.
Door will not open.	Oven is still in self-clean mode. If oven is hot, door latch will release when a safe temperature is reached
Oven light will not work.	Light bulb is burned out. Oven is not connected to power.

Service Information

If service is required, call your dealer or authorized service agency. The name of the authorized service agency can be obtained from the dealer or distributor in your area.

Have the following information readily available.

- Model number
- Serial number
- Date purchased
- Name of dealer from whom purchased

Clearly describe the problem that you are having. If you are unable to obtain the name of an authorized service agency, or if you continue to have service problems, contact Viking Range Corporation at 1-888-VIKING1 (845-4641), or write to:

**VIKING RANGE CORPORATION
PREFERRED SERVICE
1803 Hwy 82W
Greenwood, Mississippi 38930 USA**

Record the information indicated below. You will need it if service is ever required. The model and serial number for your oven can be found by opening the door and looking underneath the control panel on the left hand side.

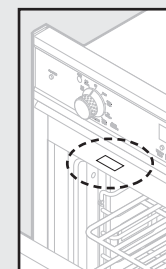

Model no. _____ Serial no. _____

Date of purchase _____ Date installed _____

Dealer's name _____

Address _____

If service requires installation of parts, use only authorized parts to insure protection under the warranty.

Keep this manual for future reference.

Warranty

BUILT-IN ELECTRIC OVENS WARRANTY

ONE YEAR FULL WARRANTY

Built-in electric ovens and all of their component parts and accessories, except as detailed below*, are warranted to be free from defective materials or workmanship in normal household use for a period of twelve (12) months from the date of original retail purchase. Viking Range Corporation, warrantor, agrees to repair or replace, at its option, any part which fails or is found to be defective during the warranty period.

*Glass (including light bulbs), painted and decorative items are warranted to be free from defective materials or workmanship for a period of ninety (90) days from the date of original retail purchase. ANY DEFECTS MUST BE REPORTED TO THE SELLING DEALER WITHIN NINETY (90) DAYS FROM DATE OF ORIGINAL RETAIL PURCHASE.

Viking Range Corporation uses the most up-to-date processes and best materials available to produce all color finishes. However, slight color variation may be noticed because of the inherent differences in painted parts and porcelain parts as well as differences in kitchen lighting, product locations, and other factors.

FIVE YEAR LIMITED WARRANTY

Any bake element, broil element, or convection cook element which fails due to defective materials or workmanship in normal household use during the second through fifth year from the date of original retail purchase will be repaired or replaced, free of charge for the part itself, with the owner paying all other costs, including labor.

TEN YEAR LIMITED WARRANTY

Any porcelain oven or porcelain inner door panel which rusts through due to defective materials or workmanship in normal household use during the second through the tenth year from the date of original retail purchase will be repaired or replaced, free of charge for the part itself, with the owner paying all other costs, including labor.

NINETY (90) DAY RESIDENTIAL PLUS WARRANTY This warranty applies to applications where use of the product extends beyond normal residential use. Examples are, but not limited to, bed and breakfasts, fire stations, private clubs, churches, etc. This warranty excludes all commercial locations such as restaurants, food service locations and institutional food service locations.

This warranty extends to the original purchaser of the product warranted hereunder and to each transferee owner of the product during the term of the warranty.

This warranty shall apply to products purchased and located in the United States and Canada. Products must be purchased in the country where service is requested. Warranty labor shall be performed by an authorized Viking Range Corporation service agency or representative. Warranty shall not apply to damage resulting from abuse, accident, natural disaster, loss of electrical power to the product for any reason, alteration, outdoor use, improper installation, improper operation, or repair or service of the product by anyone other than an authorized Viking Range Corporation service agency or representative. This warranty does not apply to commercial usage. Warrantor is not responsible for consequential or incidental damage whether arising out of breach of warranty, breach of contract, or otherwise. Some jurisdictions do not allow the exclusion or limitation of incidental or consequential damages, so the above limitation or exclusion may not apply to you.

Owner shall be responsible for proper installation, providing normal care and maintenance, providing proof of purchase upon request, and making the appliance reasonably accessible for service. If the product or one of its component parts contains a defect or malfunction during the warranty period, after a reasonable number of attempts by the warrantor to remedy the defects or malfunctions, the owner is entitled to either a refund or replacement of the product or its component part or parts. Warrantor's liability on any claim of any kind, with respect to the goods or services covered hereunder, shall in no case exceed the price of the goods or service or part thereof which gives rise to the claim.

WARRANTY SERVICE:

Under the terms of this warranty, service must be performed by a factory authorized Viking Range Corporation service agent or representative. Service will be provided during normal business hours, and labor performed at overtime or premium rates shall not be covered by this warranty. To obtain warranty service, contact the dealer from whom the product was purchased, an authorized Viking Range Corporation service agent, or Viking Range Corporation. Provide model and serial number and date of original purchase. For the name of your nearest authorized Viking Range Corporation service agency, call the dealer from whom the product was purchased or Viking Range Corporation. **IMPORTANT:** Retain proof of original purchase to establish warranty period.

The return of the Owner Registration Card is not a condition of warranty coverage. You should, however, return the Owner Registration Card so that Viking Range Corporation can contact you should any question of safety arise which could affect you.

Any implied warranties of merchantability and fitness applicable to the above described bake element, broil element, convection cook element, porcelain oven, or porcelain inner door panel are limited in duration to the period of coverage of the applicable express written limited warranties set forth above. Some jurisdictions do not allow limitations on how long an implied warranty lasts, so the above limitation may not apply to you. This warranty gives you specific legal rights, and you may also have other rights which may vary from jurisdiction to jurisdiction.

Specifications subject to change without notice.