

# Hisense

life reimagined

## **USER'S OPERATION MANUAL**

Before operating this unit, please read this manual thoroughly, and retain for future reference.

HRCD615TBWV

EN

English

# Contents

**Thank you for choosing Hisense. We are sure you will find your new refrigerator a pleasure to use. However, before you use the appliance, we recommend that you carefully read the instructions, which provide details about installing and using the product. Please keep this manual for future reference.**

Safety and warning information .....	01
Installing your new appliance.....	13
Description of the appliance .....	21
Display controls.....	22
Using your appliance .....	29
Cleaning and care.....	32
Helpful hints and tips .....	34
Troubleshooting.....	36
Disposal of the appliance .....	40
Suggestion of using the appliance.....	41

## Safety and warning information

For your safety and correct usage before installing and first using the appliance, read this user manual carefully, including its hints and warnings. To avoid unnecessary mistakes and accidents, it is important to make sure that all people using the appliance are thoroughly familiar with its operation and safety features. Save these instructions and be sure that they remain with the appliance if it is moved or sold, so that anyone using it throughout its life, will be properly informed on its usage and safety notices. For the safety of life and property, keep the precautions of these user's instructions as the manufacturer is not responsible for damages caused by omission.



### **Safety for children and others who are vulnerable people**

#### **According to EN standard**

This appliance can be used by children aged from 8 years and above and persons with reduced physical, sensory or mental capabilities or lack of experience and knowledge if they have been given supervision or instruction concerning use of the appliance in a safe way and understand the hazards involved. Children shall not play with the appliance. Cleaning and user maintenance shall not be made by children without supervision.

# Safety and warning information



## Safety for children and others who are vulnerable people

### According to IEC standard

This appliance is not intended for use by persons (including children) with reduced physical, sensory or mental capabilities, or lack of experience and knowledge, unless they have been given supervision or instruction concerning use of the appliance by a person responsible for their safety. Children should be supervised to ensure that they do not play with the appliance.

Keep all packaging away from children as there is risk of suffocation.

If you are discarding the appliance, pull the plug out of the socket, cut the connection cable (as close to the appliance as you can) and remove the door to prevent children playing from suffering an electric shock or from closing themselves inside it.

If this appliance, featuring a magnetic door seals, is to replace an older appliance having a spring lock (latch) on the door or lid, be sure to make the spring lock unusable before you discard the old appliance. This will prevent it from becoming a death trap for a child.

# Safety and warning information

## General safety

- **WARNING**

This appliance is designed for household and similar applications, including but not limited to:

1. Staff kitchen areas in shops, offices and other working environments;
2. Farm houses and by clients in hotels, motels and other residential type environments:
  - 1) bed and breakfast type environments;
  - 2) catering and similar non-retail applications.

- **WARNING**

Do not store explosive substances such as aerosol cans with a flammable propellant in this appliance.

- **WARNING**

If the supply cord is damaged, it must be replaced by the manufacturer, its service agent or similarly qualified persons in order to avoid a hazard.

- **WARNING**

Keep ventilation openings, in the appliance enclosure or in the built-in structure, clear of obstruction.



**Warning: Risk of fire / flammable materials**

# Safety and warning information



## General safety

- **WARNING**

Do not use mechanical devices or other means to accelerate the defrosting process, other than those recommended by the manufacturer.

- **WARNING**

Do not damage the refrigerant circuit.

- **WARNING**

Do not use electrical appliances inside the food storage compartments of the appliance, unless they are of the type recommended by the manufacturer.

- **WARNING**

The refrigerant and insulation blowing gas are flammable. When disposing of the appliance, do so only at an authorized waste disposal centre. Do not expose to flame.

- **WARNING**

When positioning the appliance, ensure the supply cord is not trapped or damaged.

# Safety and warning information

## General safety

- **WARNING**

Do not locate multiple portable socket-outlets or portable power supplies at the rear of the appliance.

## Replacing the illuminating lamps

- **WARNING**

The illuminating lamps must not be replaced by the user! If the illuminating lamps are damaged, contact the customer helpline for assistance. This warning is only for refrigerators that contain illuminating lamps.

## Refrigerant

The refrigerant isobutane (R600a) is contained within the refrigerant circuit of the appliance, a natural gas with a high level of environmental compatibility, which is nevertheless flammable. During transportation and installation of the appliance, ensure that none of the components of the refrigerant circuit becomes damaged. The refrigerant (R600a) is flammable.

# Safety and warning information

## Refrigerant

- **WARNING**

Refrigerators contain refrigerant and gases in the insulation. Refrigerant and gases must be disposed of professionally as they may cause eye injuries or ignition. Ensure that tubing of the refrigerant circuit is not damaged prior to proper disposal.

- **WARNING**

Risk of fire / flammable materials If the refrigerant circuit should be damaged:

1. Avoid opening flames and sources of ignition.
2. Thoroughly ventilate the room in which the appliance is situated.

It is dangerous to alter the specifications or modify this product in any way. Any damage to the cord may cause a short circuit, fire, and/or electric shock.

# Safety and warning information



## Electrical safety

1. The power cord must not be lengthened.
2. Make sure that the power plug is not crushed or damaged. A crushed or damaged power plug may overheat and cause a fire.
3. Make sure that you can access the main plug of the appliance.
4. Do not pull the main cable.
5. If the power plug socket is loose, do not insert the power plug. There is a risk of electric shock or fire.
6. You must not operate the appliance without the interior lighting lamp cover.
7. The fridge is only applied with power supply of single phase alternating current of 220~240V/50Hz. If fluctuation of voltage in the district of user is so large that the voltage exceeds the above scope, for safety's sake, be sure to apply A.C. Automatic voltage regulator of more than 350W to the fridge. The fridge must employ a special power socket instead of common one with other electric appliances. Its plug must match the socket with ground wire.

# Safety and warning information

## Daily use

- Do not store flammable gases or liquids in the appliance, There is a risk of an explosion.
- Do not operate any electrical appliances in the appliance (e.g. electric ice cream makers, mixers etc.).
- When unplugging always pull the plug from the mains socket, do not pull on the cable.
- Do not place hot items near the plastic components of this appliance.
- This refrigerating appliance is not intended to be used as a built-in appliance.
- Do not place food products directly against the air outlet on the rear wall.
- Store pre-packed frozen food in accordance with the frozen food manufacturers' instructions.
- The appliances manufacturers' storage recommendations should be strictly adhered to. Refer to relevant instructions for storage.
- Do not place carbonated or fizzy drinks in the freezer compartment as it creates pressure on the container, which may cause it to explode, resulting in damage to the appliance.
- Frozen food can cause frost burns if consumed straight from the freezer compartment.

## Safety and warning information

- Do not place the appliance in direct sunlight. Keep burning candles, lamps and other items with naked flames away from the appliance so that do not set the appliance on fire.
- The appliance is intended for keeping foodstuff and/or beverages in normal household as explained in this instruction booklet. The appliance is heavy. Care should be taken when moving it.
- Do not remove nor touch items from the freezer compartment if your hands are damp/wet, as this could cause skin abrasions or frost/freezer burns.
- Never use the base, drawers, doors etc. to stand on or as supports.
- Frozen food must not be refrozen once it has been thawed out.
- Do not consume ice popsicles or ice cubes straight from the freezer as this can cause freezer burn to the mouth and lips.
- To avoid items falling and causing injury or damage to the appliance, do not overload the door racks or put too much food in the crisper drawers.
- Food needs to be packed into bags before it is put into the refrigerator. Liquids need to be stored in bottles or capped containers in order to avoid a spill, as the design structure of the product is not easy to clean.

## Safety and warning information

- In order to sense the temperature and humidity near the appliance and make the appliance run better, add temperature and humidity sensor outside the box of appliance.

### **Caution! Care and cleaning**

- Before maintenance, switch off the appliance and disconnect the mains plug from the mains socket.
- Do not clean the appliance with metal objects, steam cleaner, ethereal oils, organic solvents or abrasive cleansers.
- Do not use sharp objects to remove frost from the appliance. Use a plastic scraper.
- Water dispenser cleaning: Clean water tank if it has not been used for 48h. Flush the water system connected to a water supply if water has not been drawn for 5 days.

# Safety and warning information

## Installation Important

- For electrical connection carefully, follow the instructions given in this manual. Unpack the appliance and check if there are damage on it.
- Do not connect the appliance if it is damaged. Report possible damages immediately to the place you bought it. In this case retain packing.
- It is advisable to wait at least four hours before connecting the appliance to allow the oil to flow back in the compressor.
- Adequate air circulation should be around the appliance, lacking this leads to overheating. To achieve sufficient ventilation, follow the instructions relevant to installation.
- Wherever possible the back of the product should not be too close to a wall to avoid touching or catching warm parts (compressor, condenser) to prevent the risk of fire, follow the instructions relevant to installation.
- The appliance must not be located close to radiators or cookers.
- Make sure that the mains plug is accessible after the installation of the appliance.
- This equipment should be installed and operated with minimum distance 20cm between the radiator & your body.

# Safety and warning information

## Service

- Any electrical work required to do the servicing of the appliance should be carried out by qualified electrician or competent person.
- This product must be serviced by an authorized Service Center, and only genuine spare parts must be used:
  1. If the appliance is Frost Free.
  2. If the appliance contains freezer compartment.
- Queensland service notes: In Queensland, the Authorized Service Person Must hold a Gas Work Authorization for hydrocarbon refrigerants to carry out servicing or repairs which involve removal of covers.

### Note

Children aged from 3 to 8 years are allowed to load and unload refrigerating appliances. (This clause applies only to the EU region.)

# Installing your new appliance

Before using the appliance for the first time, you should be aware of the following tips.



## Ventilation of appliance

In order to improve efficiency of the cooling system and save energy, it is necessary to maintain good ventilation around the appliance for the dissipation of heat. For this reason, sufficient clear space should be available around the refrigerator.

### Suggest:

It is advisable for there to be at least 2"(50mm) of space from the back to the wall, at least 1/2"(12mm) from its top, at least 1/2"(12mm) from its side to the wall and a clear space upfront to allow the door to open 125°. See in follow diagrams.

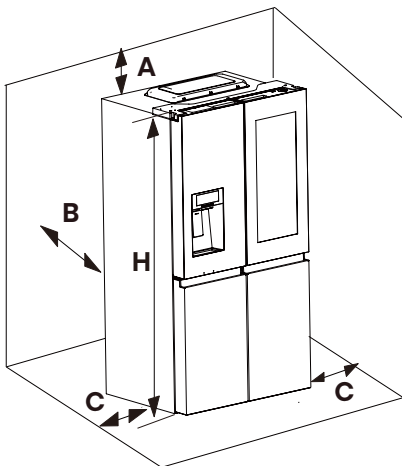

**A** > 1/2" (12mm)    **B** > 2" (50mm)  
**C** > 1/2" (12mm)

## Relevant information (mm)

W	D	H	W1	W2	W3	D1	D2
914	730	1790	908	996	1474	610	1108

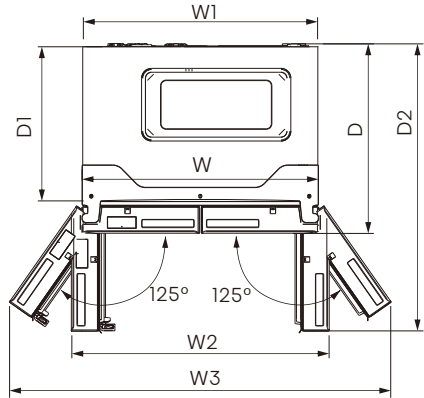

## Note

This appliance performs well in the climate class from SN to T. It may not work properly if being left at a temperature above or below the indicated range for a long period.

Climate class	Ambient temperature
SN	+10°C to +32°C
N	+16°C to +32°C
ST	+16°C to +38°C
T	+16°C to +43°C

Stand your appliance in a dry place to avoid high moisture damage. Keep the appliance out of direct sunlight, rain or frost. Stand the appliance away from heat sources such as stoves, fires or heaters.

# Installing your new appliance

## Leveling of appliance(if needed)

- For sufficient leveling and air circulating in the lower rear section of the appliance, the bottom feet may need to be adjusted. You can adjust them manually by hand or by using a suitable spanner.
- To allow the doors to self-close, tilt back the top backwards at about 15mm by turning the adjustable feet.
- Whenever you want to move the appliance, remember to turn the feet back up, so that the appliance can roll freely. Reinstall the appliance when relocating.

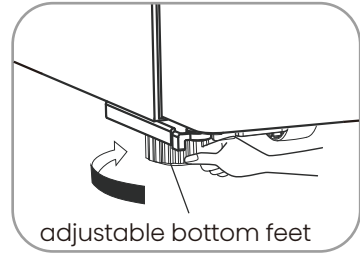

## Warning

- For proper installation, this refrigerator must be placed on a level surface of hard material that is the same height as the rest of the flooring. This surface should be strong enough to support a fully loaded refrigerator.
- The rollers, which are not castors, should be only used for forward or backward movement. Moving the refrigerator sideways may damage your floor and the rollers.
- It is advisable to adjust both the bottom feet until they touch the ground after placing the refrigerator.

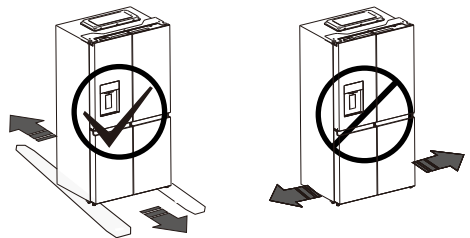
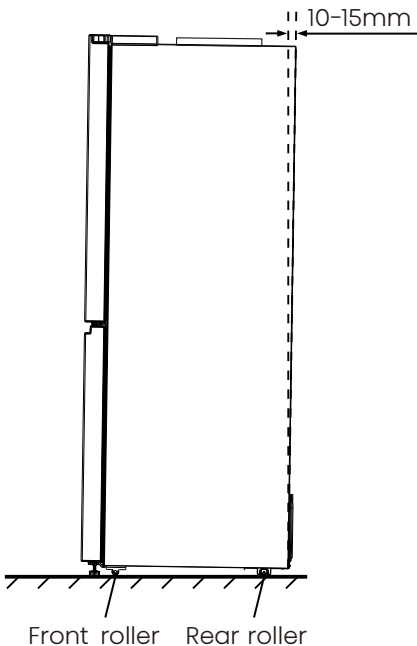



# Installing your new appliance

In case your home access door is too narrow for the refrigerator to pass through, remove the doors.

## Warning

- Disconnect power before removing doors.
- Reconnect ground wire before operating.
- Failure to do so could result in death or electric shock.

### Tools you will need(Not provided):

	
Allen Wrench (5/32" 4mm)	Wrench (5/16" mm)
	
Phillips Screwdriver	

### Door Removal (if needed)

1. With the door closed, remove the 3 screws holding the top covers (1) with phillips(+) screwdriver, and then remove the top cover.

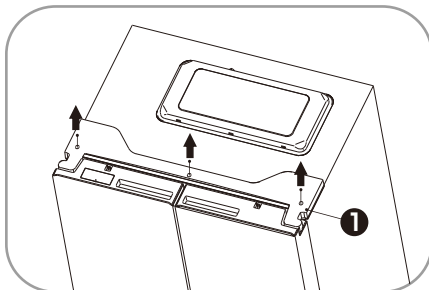

2. Separate the two connectors on the left side door. To remove the wire connector, press the top of the connector(2) and separate it from the other one. To remove the water coupler from the hinge, twist and pull the clip(3) from the coupler. Remove the water line(4) while pressing the movable part(5) of the water line coupler.

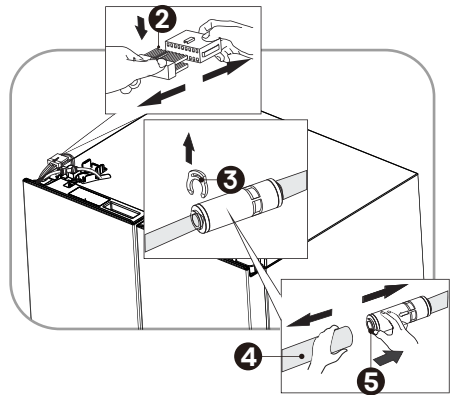

3. Remove the screws(6) fixed on the upper hinges with a wrench(5/1" .8mm) and the ground screw(7) attached to the hinge with phillips(+) screwdriver. Remove the upper left and right door hinges(8).

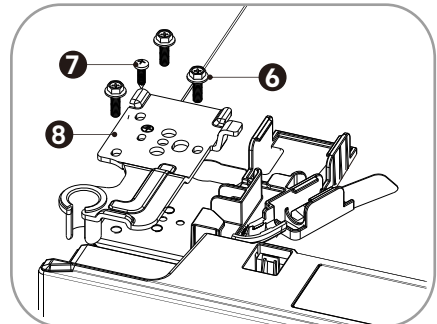

# Installing your new appliance

4. Use both hands to open the door more than 90°. Lift it up and take it off.

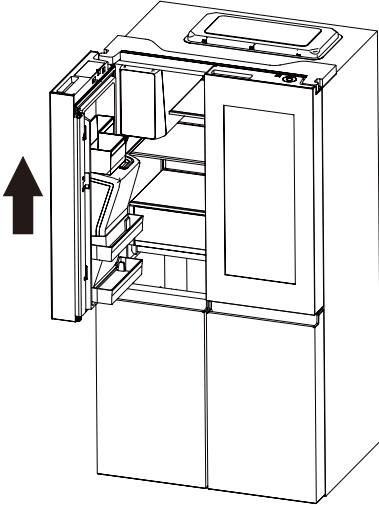

5. Remove the screws (9) fixed on the middle hinges with an allen wrench (5/32", 4mm). Remove the middle left and right hinges (10).

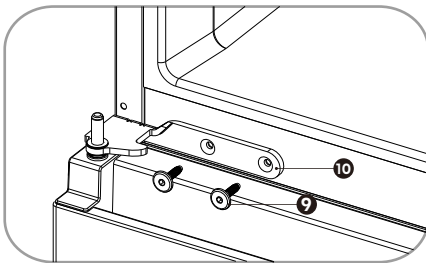

## Re-assembling the doors

To reattach the doors after you moved the appliance to its final location, assemble the parts in reverse order.

## Align Door (if needed)

Due to uneven ground or other factors, if the refrigerator door is uneven, you can level the door in the following ways.

1. If the refrigeration right door is low, you can lift the refrigeration right door and snap the gasket in the accessory bag onto the hinge shaft at the lower end of the entry body.

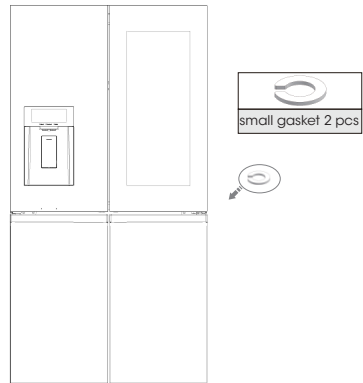

2. You can adjust the door body on the same side of the feet by adjusting the bottom feet.

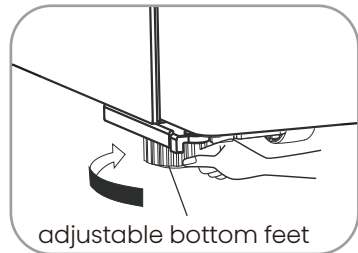

# Installing your new appliance

## Connect the Water Supply









A water dispenser with a filter is one of the helpful features on your new appliance. To help promote better health, the water filter removes unwanted particles from your water. However, it does not sterilize or destroy microorganisms. You may need to purchase a water purifying system to do that.

In order for the ice maker to operate properly, a water pressure of 206~862KPa is required. Under normal conditions, a 200mL (5.75 oz.) cup can be filled in about 10 seconds. If the refrigerator is installed in an area with low water pressure (below 206KPa), you can install a booster pump to compensate for the low pressure. After you have connected the water tube, make sure the water storage tank inside the refrigerator is properly filled. To do this, press the water dispenser lever until the water runs from the water outlet.

Parts for water line installation:

The tools you will need:

(The 3/4" BSP connector and the check valve are provided as one part)

			
3/4" BSP connector and Check valve	Two-Way Connector	Valve Seat	Screw
			
Phillips screwdriver	1/4" extension water tube	Spanner	Clip

Connecting to the water supply line:

### Warning

- The connection steps must follow the sequence showing below, otherwise it may cause water line break and water leakage!
- The water line must be connected with the potable water only.
- You should use the new 3/4" BSP connector and the check valve incidentally but not the old one you have.
- Use only the new water tubes supplied with the refrigerator. Old water tubes should not be used.
- The water supply line must be connected to the cold water pipe. If it is connected to the hot water pipe, it may cause the purifier to malfunction.

1. Turn off the main water supply line.

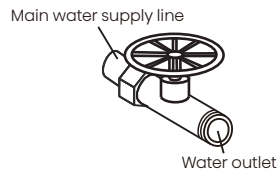

2. Screw the 3/4" BSP connector onto the suitable water outlet.

# Installing your new appliance

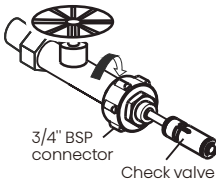

3. Use the spanner to tighten it.

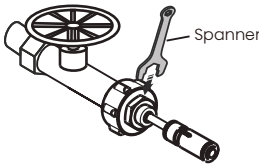

4. Fully insert the filter inlet line (or 1/4" extension water tube) into the check valve.

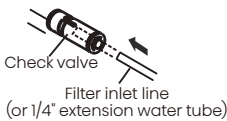

5. Insert the clip into the installation pack as the figure shown below.

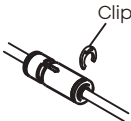

6. To prevent the clips loose, use the valve seat to hold it. Then use the screw to hold the valve seat with Philips screwdriver.

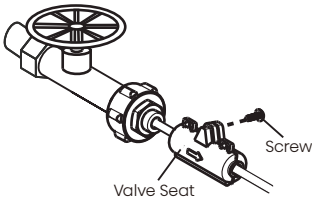

## Warning

- The water tubes should not be pressed by heavy things and should not bend too much.
- After turning on the water supply line, make sure that there is no leakage at all connection points of the water tubes. If there is a leakage, turn off the water supply line immediately and tighten the water connector or make the water tubes fully inserted into the connectors.

## Note:

- After connected to the main water supply line, please open the water valve to flush the filter for 5 minutes before use. The initial dark discoloration of water is normal.
- If the main water supply line is too far away from the refrigerator to be connected to the filter inlet line, the 1/4" extension water tube (about 5m) - provided may be helpful, cut it to the suitable length and connect it with the filter inlet line by a Two-Way Connector. The water tube should not be cut too short or too long. If it is too short, it will be tightened and cannot be fully inserted into the connector. If it is too long, it will curl and break easily.

# Installing your new appliance

- The water tube must be fully inserted into the center of the connector to prevent water leaking. Insert the 2 clips in the installation pack as shown in the diagram, and then confirm that each clip holds the line firmly.
- It is normal that there will be sound of exhaust coming out from the appliance when you connect the water line to the appliance and press the lever of the dispenser for the first time.

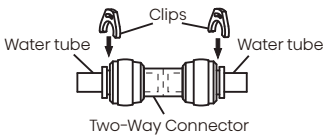

Connection status without extension water tube:

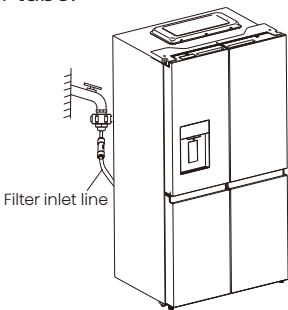

Connection status with extension water tube:

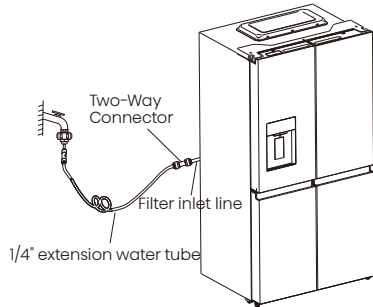

## Note:

Your product may look different from this image in this instruction, depending on your model's features.

## Changing the water filter

To drink the freshest and cleanest water from your refrigerator, change the filter on time. To change the water filter, follow these steps:

1. Shut off the water supply. Pull out the cover (B) about 1.5 cm and open.

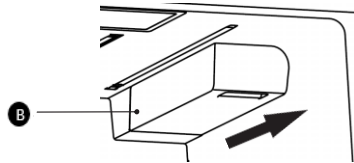

2. Turn the water filter (C) about 1/4 turn.

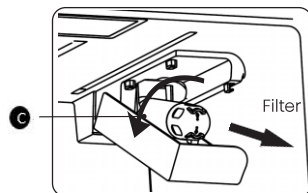

# Installing your new appliance

- Sometimes, it is hard to disassemble the water filter because impurities in the water cause it to stick. If you are having difficulties, grip the water filter firmly and pull it out.
- When you pull the water filter, a little water can leak from the opening. This is normal. To minimize the water leaks, keep the filter cartridge horizontal when pulling it. To insert the new water filter, follow the directions below.

3. Insert the new filter into the filter holder.

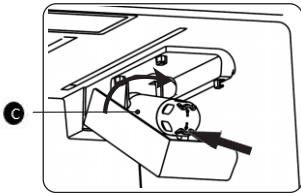

4. Push the filter, and then turn it clockwise until it locks.

If you have trouble inserting the water filter because of high water pressure, shut off the water supply valve.

5. If you turned off the water supply, turn it back on.

## Note.

- After turning on the water supply, you should check the leaks. If leaks occur, repeat the steps 1- 5.
- If leaks persist, discontinue use and call customer service.

- In general, in order to ensure the quality of drinking water, you need to change the water filter every 6 months.

Removing any residual matter inside the water supply line after installing the water filter.

1. After the water filter is replaced, dispense 2.5 gallons of water (flush for approximately 5 minutes) to remove trapped air and contaminants from the system.
2. Additional flushing may be required in some households.
3. Open the refrigerator door and make sure there are no water leaks coming from the water filter.

# Description of the appliance

## View of the appliance

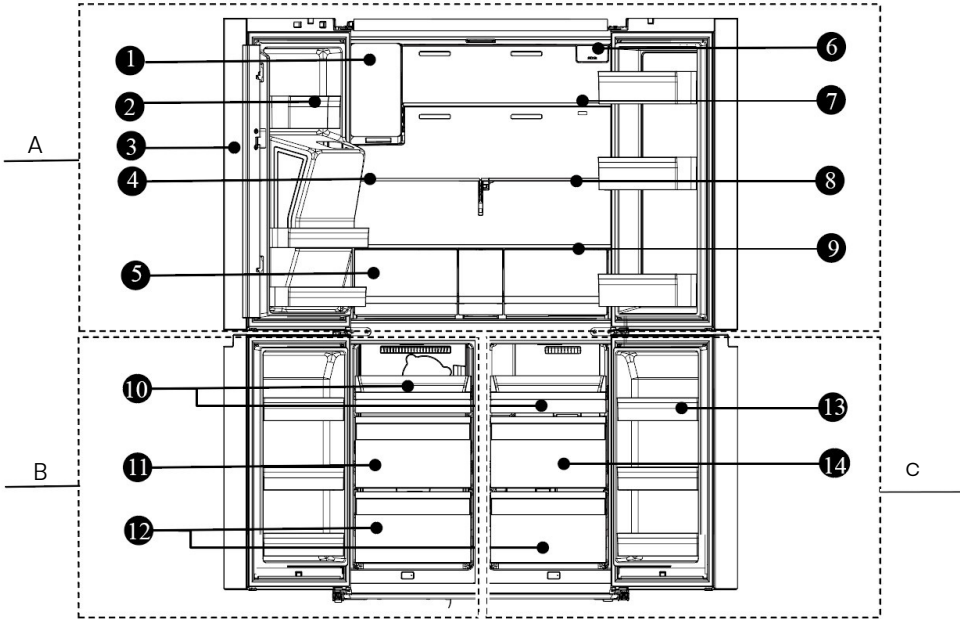

### A: Fridge

1. Ice chamber component
2. Door shelves
3. Rotary Separator
4. Half-size glass shelf
5. Drawer

### B: Freezer

6. Water filter
7. Full-size glass shelf
8. Foldable glass shelf
9. Crisper cover
10. Upper trays
11. Freezer middle drawer
12. Lower drawers

### C: MyFreshChoice

13. Door shelves
14. MyFreshChoice middle drawer



Due to constant development of our products, your refrigerator may be slightly different from this instruction manual, but its functions and usage remain the same.

To get the best energy efficiency of this product, please place all shelves, drawers on their original position as the illustration above.

# Display controls

This product has a display located on the refrigerator door, please follow the instructions below.

The picture below is a photo of the home page, and the home icon can be swiped left and right. Click the icon to enter the corresponding function.

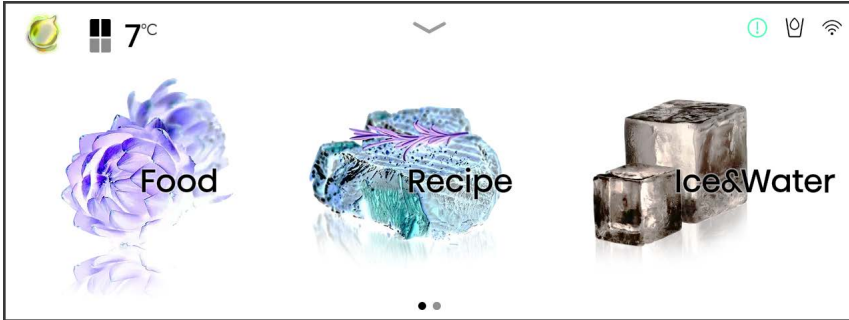

The picture below is the refrigerator control, which can adjust the refrigerator temperature and mode.

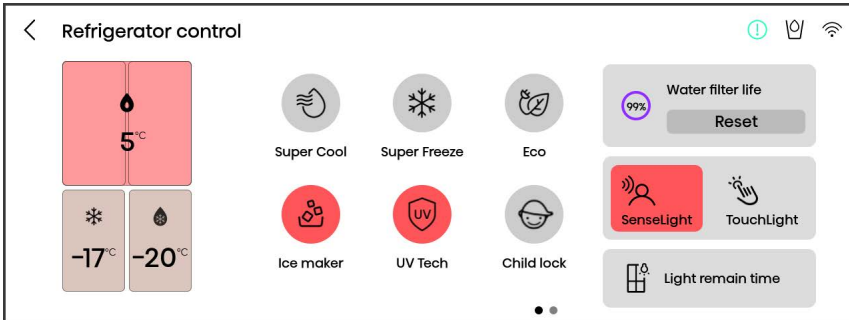

When the refrigerator is powered on, the display will light up, and the display will enter the screensaver and turn off the screen for a set time for the user. The display consists of two display areas, one is the display area and the other is the ice water mode button.

## Caution!

When you set the temperature of your

refrigerator, that temperature only refers to the average temperature of the corresponding area of your refrigerator. The temperature of each area inside the refrigerator will vary from the temperature shown on the display panel, and the difference will depend on how much food you have in that area and where you

# Display controls

store it. Excessive or low room temperatures may also affect the actual temperature inside the refrigerator.



## Child Lock

Turn on the child lock: When you open the child lock, it will prompt "Turn on Child Lock? You will not be able to access ice or water while activated." If the user clicks confirm, it will be turned on and the icon will light up. After opening, the user presses the dispenser lever and cannot get out of ice or water. When the user touches the Cubed/Crushed/Water button, or presses the dispenser lever, a prompt will pop up on the screen.

Turn off the child lock: Tap the "🔒" icon in lit mode, and the "🔒" icon is off, indicating that the child lock is turned off.



## Door Alarm

When the door is opened to alarm, the display screen will pop up the door opening alarm prompt, and send out a prompt sound. When the user clicks to know or close the refrigerator door, the alarm and prompt will disappear.



## Ice Maker

This button controls the ice maker. You can control the ice maker by pressing the button "❄️". When the "❄️" icon lights up, it indicates that the ice maker has started working. If you want to turn off the ice maker, touch the "❄️" button again until the "❄️" icon turns off.

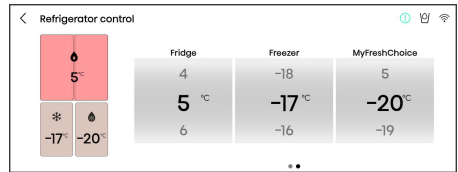

## Fridge Temperature Control

You can adjust the temperature of the refrigerator by using the corresponding wheel of "Fridge". When the temperature unit is "°F", the temperature will be displayed from 46°F to 36°F.

If the temperature unit is "°C", the temperature will be displayed from 8°C to 2°C.

If you want to reduce the time it takes to cool down in the refrigerator, tap on the "❄️" icon, the Super Cool icon lights up and the refrigerator temperature is displayed at 36°F (2°C). The Super Cool will automatically turn on for 6 hours and then turn off, and the refrigeration temperature will return to the previous setting.

# Display controls

When the Super Cool function is on, you can tap the "🌀" icon again, the Super Cool mode will be turned off, and the refrigeration temperature will return to the previous setting. When the refrigerator is re-energized, the Super Cool is not turned on.

## Freezer Temperature Control

You can adjust the temperature of the freezer chamber by using the corresponding scroll wheel of the "Freezer".

When the temperature unit is °F, the temperature will be displayed from 7°F to -11°F.

When the temperature unit is °C, the temperature will be displayed from -14°C to -24°C.

If you want to shorten the time it takes to freeze a product in the freezer, tap the "❄️" icon, the "❄️" icon will light up and the freezer temperature will be -11°F (-24°C). Super Freeze can quickly lower the temperature and freeze food faster than usual, which can retain more vitamins and nutrients in fresh food, making food last longer. Super Freeze mode allows you to freeze items at top speed, we recommend that your device run for 6 hours first. After 52 hours, the Super Freeze will automatically turn off and the freezer temperature will return to the previous

setting. When the Super Freeze feature is turned on, you can tap the "❄️" icon again, the Super Freeze will turn off and the freezing temperature will return to the previous setting.

**Note:** When selecting the Super Freeze function, ensure there are no bottles in the freezer compartment. Bottles and cans may explode.

## MyFreshChoice Temperature Control

You can adjust the temperature of the MyFreshChoice chamber by using the corresponding scroll wheel of the "MyFreshChoice". When the temperature unit is °F, the temperature will be displayed from 41°F to -4°F.

When the temperature unit is °C, the temperature will be displayed from 5°C to -20°C.



You can press "🌿" to turn the energy-saving mode on or off. When the energy-saving mode is turned on, the button "🌿" light is on. The refrigeration temperature automatically switches to 43°F (6°C) and the freezing temperature automatically switches to 1°F (-17°C). When the energy-saving mode is turned off, the button "🌿" light goes out and the temperature

# Display controls

automatically returns to the set temperature. When you enter the energy-saving mode, the "Super Freeze" and "Super Cool" modes are turned off.

## Changing the water filter

After drinking about 1,000 gallons of water (about 6 months after using the filter), the filter icon will alert you to the need to change the filter. First, you'll need to purchase a new filter. You can purchase the filter at the point of sale where you purchased the fridge or at the Hisense after-sales service point. Before purchasing, you need to check that the new filter matches the old one so that it matches your fridge. After changing the filter, make sure to press the "Reset" button. When you change the filter, a little water will leak out of the filter and pipes. Catch the water in a container and wipe it dry.

## °F/°C: Convert button

There is a temperature unit toggle button in the settings, and you can touch the °F/°C button to make the temperature switch between Celsius and Fahrenheit.



## Dispenser control

When the child lock icon light is on, the dispenser stops working. The ice cube shape type is selected by the "Cubed" and "Crushed" buttons, and the "Water" button is touched to activate the drinking mode. When the Ice Cube type button is touched, the selected Ice Cubed or Ice Crushed mode is activated, and the Ice Cubed or Ice Crushed icon lights up on the display interface.

If ice is not needed, turn it off to save water and energy consumption (see "Ice Maker" above). If you need water, touch the "Water" button and the water icon will light up on the display interface.

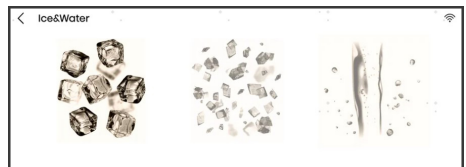

Ice&Water selection screen

## Networking

Through the wireless network function in the settings, the user selects the Wi-Fi account to be connected and enters the corresponding password to connect to the network.

# Display controls



## Network connection

The device will use and store the Wi-Fi information you enter to provide network-related services. For the processing of personal information after connecting to the network, please refer to the privacy policy. After connecting to the network, a Wi-Fi icon appears on the screen.

## ConnectLife App

The ConnectLife App is available to download free of charge from the Apple App Store or from the Google Play Store.



## Mobile phone binding

Go to Settings and find "APP and Pairing"

- 1.If you already have a mobile app, then proceed to the next step.
- 2.After logging in to the mobile APP, click "+" in the lower right corner of the mobile APP, select the scan code function, and scan the QR code information displayed on the code display.

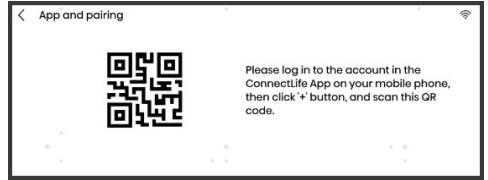

3.According to the prompts on the display interface, the binding is successful or continue to scan the barcode of the device in the refrigerator.

4.After successful binding, if you want to control the temperature or mode of the refrigerator through your mobile phone, you need to turn on the "Remote Control" switch on the display end.

As the application continues to be upgraded, please refer to the actual display interface.

The user's data can be deleted through the Factory reset function in the settings. The Wi-Fi interface of the device is enabled by default, which is used for the device to configure the network and connect to the Internet.

The device is restricted to indoor use when operation in the 5150-5350MHz frequency range.

For BT: 2400-2483.05MHz@5.33 dBm; For 2.4G Wi-Fi: 2400-2483.05MHz@15.54 dBm;

For 5G Wi-Fi: 5150-5875MHz@14.71 dBm; For 24G proximity sensors:24.00GHz to 24.25GHz :11.55dBm(Max EIRP);

# Display controls



## UV Tech

The function of UV sterilization is turned on by default, and the "UV" icon is lit up. When water dispenser need water, the UV sterilization module lights up to sterilize the water. Click the "UV" icon to turn the UV sterilization function on or off. When the "UV" icon goes off and the sterilization module stops working.



## SenseLight

After turning on this function, the light will be triggered by the user's movement at a distance of about 1m in front of the refrigerator. The "TouchLight" lighting function is turned off.

**Note:** The sensing distance will vary according to different use environments, which is a normal phenomenon.



## TouchLight

When the "TouchLight" icon is highlighted, touch the touch-sensitive area at the bottom of the right door of the refrigerator compartment with your hand to light up the refrigerator light. When this feature is turned on, the "SenseLight" illumination function is turned off.



## Light remain time

Users can customize the delayed lights-out time according to their actual usage.

When the "SenseLight" mode is set, the user is delayed to set the lights-out time to turn off the lights after the refrigerator does not detect the user. When the "TouchLight" mode is set, turn on the refrigerator freezer light, then turn off the light after the user sets the lights-out time.

## To switch on/off the display

The button is located at the top of the left door.

1. You can press "ON" to switch on the display.



2. You can press "OFF" to switch off the display.



# Display controls

When the screen freezes or has other problems, you can try to power off the screen by switching off, and then press "ON" to restart the screen.

**Note:** Do not turn off the power of the screen during daily use, otherwise you cannot use the ice water selection button.

## Voice assistant

Say "Hi, VIDAA" to activate the Voice Assistant. A prompt will appear when you use it for the first time, and click the "OK" button, you can jump to the voice settings screen. On this page, you can set the voice switch and view the voice-related instructions.

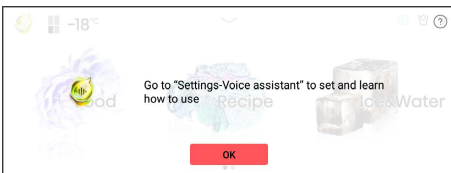

When using the voice function, it is recommended to keep a distance of about 1-2m directly in front of the refrigerator.

When the ambient noise is high, it may affect the voice interaction effect.

## Demo Mode

Demo mode is used for store display, this mode can prevent the refrigerator from generating cooling air. In this mode, the refrigerator can appear to be working, but it will not cool. After entering the demo mode, the temperature will display "OF". After entering the settings interface, you can exit the demo mode after quickly clicking the setting title 10 times in a row.

# Using your appliance

This section tells you how to use most of the useful features. We recommend that you read through them carefully before using the appliance.

## Door rack

- It is suitable for the storage of canned liquid, bottled drinks and packed food, etc. Do not place too many heavy things in the racks.

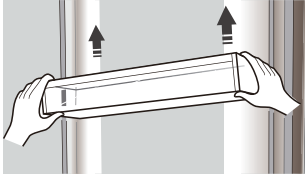

## Adjustable Shelves

The height of the shelves can be adjusted to fit your storage needs.

1. To remove the glass shelves. Tilt up the front of the shelf in the direction shown (1) and lift it up vertically (2). Pull the shelf out.

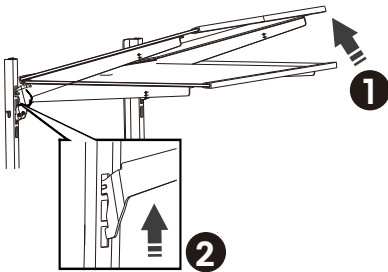

2. To re-install the glass shelves, tilt the front of the shelf up and guide the shelf hooks into the slots at a desired height (3). Then lower the front of the shelf so that the hooks can drop into the slots (4).

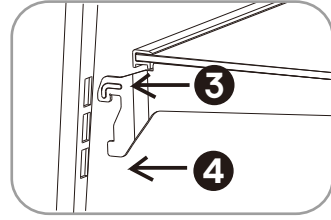

## Crisper in Refrigerator compartment

- The crisper is suitable for storage of vegetables and fruit, etc.
- Firstly pull the crisper out in level, Secondly tip up it then you can take out the crisper.
- According to the opposite sequence you can position the crisper rightly.

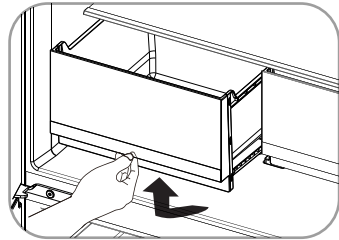

## Drawer in Freezer/MyFreshChoice compartment

- The freezer compartment is suitable for storage of foods required to be frozen, such as meat, ice.
- The MyFreshChoice compartment can be set to positive or negative temperature according to your needs to store a variety of food.
- The procedure for removing the drawers is the same as that for the crisper.

# Using your appliance

## Water Dispenser

The Water Dispenser is located at the left fridge door. You can fetch water by pressing the dispenser lever. To get ice, push the cubed or crushed ice button as required.

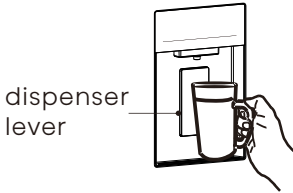

### Note:

When using it for the first time, or after a long period of non-use and then using it again, please continuously take 1 liter of water (about 1 minute) and discard it.

## Making ice

### Note:

When using it for the first time, or after a long period of non-use and then using it again, discard the first three batches of ice cubes (about 20-30 ice cubes) produced because it is unhealthy. Ice storage boxes should be cleaned at the same time.

Following installation, allow 24 hours to produce the first batch of ice cubes.

### Warning:

- Do not put food in the ice bucket. If you store food in the ice bucket, the food can strike the ice maker when you

open or close the door, causing damage to the ice maker.

- The ice cubes in the ice bucket may spill out over the drawer. If this occurs, be sure to clear the ice cubes that spilled out of the drawer.
- If a power failure occurs, ice cubes may melt, and then freeze together when the power comes back on, causing the dispenser to stop working. To prevent this problem, after a power failure, pull out the ice bucket and residual ice or water.
- If you do not use the ice for more than a week, check whether the ice is accumulated or sticky. If there is no ice produced due to ice accumulating or sticking, clean up the stored ice in time and make ice again.

## Turn off the ice maker

When you turn off the ice maker, remove all ice cubes from the bucket. If you leave the ice cubes in the bucket, the ice cubes may clump together, making it difficult to remove them. First, open the door at the maximum Angle. Then, lift up on the ice bucket, and pull it straight out in the direction of the arrow. To put the ice bucket in, push it firmly straight back. If the bucket does not fit, turn the helix 90 degrees (see the last illustration on the right, below) and try again.

# Using your appliance

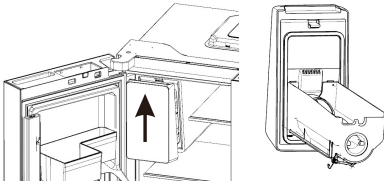
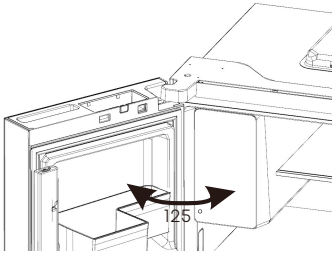

## Microphone part

The microphone part is located in the lower part of the left door of the refrigerator compartment. Do not let children use a pen or sharp object to poke the hole, and be careful not to pour water into the hole, this will affect the reception of sound.

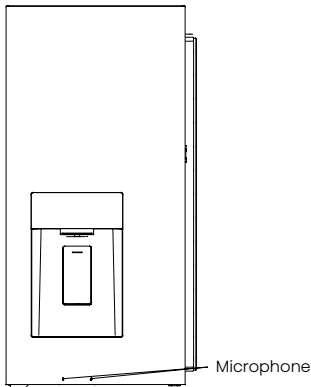

## Speaker and touchlight sensing part

The touch-sensitive area that controls the opening and closing of the refrigerator LED light is located in the illustrated area at the bottom of the refrigerator right door, note that this function can only be used when the display touchlight icon is lit. The illustrated area at the bottom of the right door of the refrigerator room is the speaker sound hole, be careful not to block it.

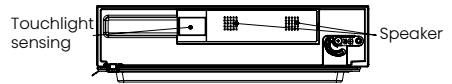

# Cleaning and care

For hygienic reasons the appliance (including exterior and interior accessories) should be cleaned regularly (at least every two months).

## Warning

- The appliance must not be connected to the mains during cleaning. Danger of electrical shock! Before cleaning switch the appliance off and remove the plug from the mains socket.

## Exterior cleaning

To maintain good appearance of your appliance, you should clean it regularly.

- Wipe the digital panel and display panel with a clean, soft cloth.
- Spray water onto the cleaning cloth instead of spraying directly on the surface of the appliance. This helps ensure an even distribution of moisture to the surface.
- Clean the doors, handles and cabinet surfaces with a mild detergent and then wiped dry with a soft cloth.



## Warning

- Do not use sharp objects as they are likely to scratch the surface.
- Do not use Thinner, Car detergent Clorox, ethereal oil, abrasive cleansers or organic solvent such as Benzene for cleaning. They may damage the surface of the appliance and may cause fire.

## Interior cleaning

- You should clean the appliance interior regularly. It will be easier to clean when food stocks are low. You can remove the drawers and shelves for a more thorough clean.
- Wipe the inside of the freezer with a weak solution of bicarbonate of soda, and then rinse with warm water using a wrung-out sponge or cloth. Wipe completely dry before replacing the shelves and baskets.
- Thoroughly dry all surfaces and removable parts before putting them back into place.

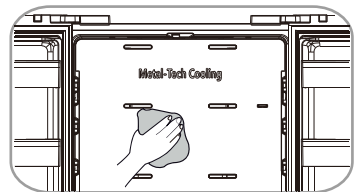

# Cleaning and care

- Although this appliance automatically defrosts, a layer of frost may occur on the freezer compartment's interior walls if the freezer door is opened frequently or kept open too long.
- If the frost is too thick, choose a time when the freezer is nearly empty and proceed as follows:
  1. Remove existing food and accessories baskets, unplug the appliance from the mains power and leave the doors open. Ventilate the room thoroughly to accelerate the process.
  2. When defrosting is completed, clean your freezer as described above.



## Warning

- Do not use sharp objects to remove frost from the freezer compartment.
- Only after the interior is completely dry should the appliance be switched back on and plugged back into the mains socket.

## Door seals cleaning

- Take care to keep door seals clean. Sticky food and drinks can cause seals to stick to the cabinet and tear when you open the door. Wash the seals with a mild detergent and warm water. Rinse and dry them thoroughly after cleaning.

## Replacing the light



## Warning

- The light should be replaced by a professional. If the light is damaged, contact the customer helpline for assistance.

# Helpful hints and tips

## Energy saving tips

We recommend that you follow the tips to save energy.

- Try to avoid keeping the door open for long periods in order to conserve energy.
- Ensure the appliance is away from any sources of heat (Direct sunlight, electric oven or cooker etc.)
- Don't set the temperature colder than necessary.
- Don't store warm food or evaporating liquid in the appliance. Place the appliance in a well ventilated, humidity free room. Please refer to the installing your new appliance chapter.
- The description of appliance diagram shows the correct combination for the drawers, crisper and shelves, do not adjust the combination as this is designed to be the most energy efficient configuration.

## Hints for fresh food refrigeration

- Do not place hot food directly into the refrigerator or freezer, the internal temperature will increase resulting in the compressor having to work harder and will consume more energy.
- Do cover or wrap the food, particularly if it has a strong flavor.
- Place food properly so that air can circulate freely around it.

## Hints for frozen food refrigeration

- Ensure that frozen food has been stored correctly by the food retailer.
- Once defrosted, food will deteriorate rapidly and should not be re-frozen.
- Do not exceed the storage period indicated by the food manufacturer.

## Hints for refrigeration

- Meat (All Types) Wrap in polythene food: wrap and place on the glass shelf above the vegetable drawer. Always follow food storage times and use by dates suggested by manufacturers.
- Cooked food, cold dishes, etc: They should be covered and may be placed on any shelf.
- Fruit and vegetables: They should be stored in the special drawer provided.
- Butter and cheese: Should be wrapped in airtight foil or plastic film wrap.
- Milk bottles: Should have a lid and be stored in the door racks.

## Hints for freezing

- When first starting-up or after a period out of use, let the appliance run at least 2 hours on the higher settings before putting food in the compartment.

# Helpful hints and tips

- Prepare food in small portions to enable it to be rapidly and completely frozen and make it possible to subsequently thaw only the quantity required.
- Wrap up the food in aluminum foil or polyethylene food wraps which are airtight.
- Do not allow fresh, unfrozen food to touch the food which is already frozen to avoid partial defrosting.
- It is recommended to label and date each frozen package in order to keep track of the storage time.

## Switching off your appliance

If the appliance needs to be switched off for an extended period, the following steps should be taken to prevent mould on the appliance.

1. Remove all food.
2. Remove the power plug from the mains socket.
3. Clean and dry the interior thoroughly.
4. Ensure that all the doors are wedged open slightly to allow air to circulate.

# Troubleshooting

If you experience a problem with your appliance or are concerned that the appliance is not functioning correctly, you can carry out some easy checks before calling for service, please see below. You can carry out some easy checks according to this section before calling for service.

## Warning

1. Don't try to repair the appliance yourself. If the problem persists after you have made the checks mentioned below, contact a qualified electrician, authorized service technician or the shop where you purchased the product.
2. A child entrapment warning statement is included below.

## Danger

Risk of child entrapment. Before you throw away your old refrigerator or freezer:

- Take off the doors.
- Leave the shelves in place so that children may not easily climb inside.

Problem	Possible Cause & Solution
Appliance is not working correctly	Check whether the power cord is plugged into the power outlet properly.
	Check the fuse or circuit of your power supply, replace if necessary.
	It is normal that the freezer is not operating during the defrost cycle, or for a short time after the appliance is switched on to protect the compressor.
Odours from the compartments	The interior may need to be cleaned.
	Some food, containers or wrapping cause odours.

# Troubleshooting

Problem	Possible Cause & Solution
Noise from the appliance	<p>The sounds below are quite normal:</p> <ul style="list-style-type: none"> <li>• Compressor running noises.</li> <li>• Air movement noise from the small fan motor in the freezer compartment or other compartments.</li> <li>• Gurgling sound similar to water boiling. Popping noise during automatic defrosting.</li> <li>• Clicking noise before the compressor starts.</li> <li>• Clicking noise when you get the water.</li> <li>• The motor running noises when you get ice.</li> </ul> <p>Other unusual noises are due to the reasons below and may need you to check and take action:</p> <ul style="list-style-type: none"> <li>• The cabinet is not level.</li> <li>• The back of appliance touches the wall.</li> <li>• Bottles or containers have fallen or are rolling.</li> <li>• The noise of water pumps and valves after the water tank is pushed in place.</li> <li>• The noise of water pumps and valves when you press the dispenser lever.</li> </ul>
The motor runs continuously	<p>It is normal to frequently hear the sound of the motor, it will need to run more when in following circumstances:</p> <ul style="list-style-type: none"> <li>• Temperature setting is set colder than necessary.</li> <li>• Large quantity of warm food has recently been stored within the appliance.</li> <li>• The temperature outside the appliance is too high.</li> <li>• Doors are kept open too long or too often.</li> <li>• After your installing the appliance or it has been switched off for a long time.</li> </ul>
A layer of frost occurs in the compartment	<p>Check that the air outlets are not blocked by food and ensure food is placed within the appliance to allow sufficient ventilation. Ensure the door can be fully closed. To remove the frost, please refer to the cleaning and care chapter.</p>
Temperature inside is too warm	<p>You may have left the doors open too long or too frequently;</p> <ul style="list-style-type: none"> <li>• Or the doors are kept open by some obstacle;</li> <li>• Or the appliance is located with insufficient clearance at the sides, back and top.</li> </ul>

# Troubleshooting

Problem	Possible Cause & Solution
Temperature inside is too cold	Increase the temperature by following the "Display controls" chapter.
Doors can't be closed easily	Check whether the top of the refrigerator is tilted back by 0.1"-0.2" (2.5-5mm) to allow the doors to self-close, or if something inside is preventing the doors from closing.
Water drips on the floor	<p>The water pan (located at the rear bottom of the cabinet) may not be properly leveled, or the draining spout underneath the top of the compressor depot may not be properly positioned to direct water into this pan, or the water spout is blocked, or the water is not fully inserted into the connector.</p> <ul style="list-style-type: none"> <li>• You may need to pull the refrigerator away from the wall to check the pan, spout and connector.</li> <li>• Check if the refrigerator is power-off for a long time, this may cause the ice in the bucket to melt into water, and flow to the floor.</li> </ul>
The light is not working	<ul style="list-style-type: none"> <li>• The LED light may be damaged. Refer to replace LED lights in cleaning and care chapter.</li> <li>• The control system has disabled the lights due to the door being kept open too long, close and reopen the door to reactivate the lights.</li> </ul>
Hear water bubbling in the refrigerator	<ul style="list-style-type: none"> <li>• This is normal. The bubbling comes from the refrigerant coolant liquid circulating through the refrigerator.</li> </ul>

# Troubleshooting

Problem	Possible Cause & Solution
Ice is not making	<ul style="list-style-type: none"> <li>• Did you wait for 24 hours after filling the water tank before making ice? If it is not sufficiently cool, it may take longer to make ice, such as when first installed.</li> <li>• Did you manually stop the ice making function? Make sure you do not turn off the ice maker.</li> <li>• Is the freezer temperature too warm? Try setting the freezer temperature lower.</li> <li>• Ice maker is not making the ice fast enough. Please wait for at least 120 minutes.</li> </ul>
Water dispenser is not functioning	<ul style="list-style-type: none"> <li>• Is the water tank pushed in place? Make sure there is enough water in the water tank.</li> <li>• Is the water line broken or bent? Make sure the water line is unblocked and clear of any obstruction.</li> <li>• Is the water tank frozen for the refrigerator temperature is too low? Try selecting a warmer setting on the display panel.</li> <li>• Is the water pump/ water valve working?</li> </ul>
Unable to connect appliance to Wi-Fi network	<ul style="list-style-type: none"> <li>• Is the password for home Wi-Fi network was entered correctly? Make sure the password is correct and connect again.</li> <li>• The device does not currently support WPA3 R3 version encrypted Wi-Fi connection, please set the router Wi-Fi to WPA, WPA2, WPA2/WPA3 encryption mode, iPhone hotspot needs to turn on compatibility mode.</li> <li>• Are the router and appliance kept far apart causing the poor network? You may experience a weak signal and encounter issues with the connection setup. Consider either moving the router closer to the appliance or purchasing Wi-Fi range extender and installing it.</li> </ul>

# Disposal of the appliance

It is prohibited to dispose of this appliance as household waste.

## Packaging materials

Packaging materials with the recycle symbol are recyclable. Dispose of the packaging into a suitable waste collection container to recycle it.

## Before disposal of the appliance

1. Pull out the mains plug from the mains socket.
2. Cut off the power cord and discard with the mains plug.



### Warning

Refrigerators contain refrigerant and gases in the insulation. Refrigerant and gases must be disposed of professionally as they may cause eye injuries or ignition. Ensure that tubing of the refrigerant circuit is not damaged prior to proper disposal.

Correct Disposal of this product	
	<p>This marking indicates that this product should not be disposed with other household wastes throughout the EU. To prevent possible harm to the environment or human health from uncontrolled waste disposal, recycle it responsibly to promote the sustainable reuse of material resources. To return your used device, please use the return and collection systems or contact the retailer where the product was purchased. They can take this product for environmentally safe recycling.</p>

# Suggestion of using the appliance

To avoid contamination of food, please respect the following instructions

- Opening the door for long periods can cause a significant increase of the temperature in the compartments of the appliance.
- Clean regularly surfaces that can come in contact with food and accessible drainage systems.
- Store raw meat and fish in suitable containers in the refrigerator, so that it is not in contact with or drip onto other food.
- Two-star frozen-food compartments are suitable for storing pre-frozen food, storing or making ice cream and making ice cubes.
- One-, two- and three-star compartments are not suitable for the freezing of fresh food.

Order	Compartments type	Target storage temp.[°C]	Appropriate food
1	Fridge	+2~+8	Eggs, cooked food, packaged food, fruits and vegetables, dairy products, cakes, drinks and other foods which are not suitable for freezing.
2	(***)*-Freezer	≤-18	Seafood (fish, shrimp, shellfish), freshwater aquatic products and meat products (recommended for 3 months ,the longer the storage time, the worse the taste and nutrition), suitable for frozen fresh food.
3	***-Freezer	≤-18	Seafood (fish, shrimp, shellfish), freshwater aquatic products and meat products (recommended for 3 months, the longer the storage time, the worse the taste and nutrition),are not suitable for frozen fresh food.
4	Wine	+5~+20	Red wine,white wine,sparkling wine etc.

## Suggestion of using the appliance

Order	Compartments type	Target storage temp.[°C]	Appropriate food
5	**-Freezer	$\leq -12$	Seafood (fish, shrimp, shellfish), freshwater aquatic products and meat products (recommended for 2 months, the longer the storage time, the worse the taste and nutrition), are not suitable for frozen fresh food.
6	*-Freezer	$\leq -6$	Seafood (fish, shrimp, shellfish), freshwater aquatic products and meat products (recommended for 1 month, the longer the storage time, the worse the taste and nutrition), are not suitable for frozen fresh food.
7	0-star	-6~0	Fresh pork, beef, fish, chicken, some packaged processed foods, etc. (Recommended to eat within the same day, preferably not later than 3 days). Partially packed/wrapped up encapsulated processed foods (non-freezable foods).
8	chill	-2~+3	Fresh/frozen pork, beef, chicken, freshwater aquatic products, etc.(7 days below 0 °C and above 0 °C is recommended for consumption within that day, preferably no more than 2 days). Seafood (less than 0°C for 15 days, it is not recommended to store above 0°C).
9	Fresh Food	0~+4	Fresh pork, beef, fish, chicken, cooked food, etc. (Recommended to eat within the same day, preferably no more than 3 days).

## Suggestion of using the appliance

### Note

please store different foods according to the compartments or target storage temperature of your purchased products.

- If the refrigerating appliance is left empty for long periods, switch off, defrost, clean, dry, and leave the door open to prevent mould developing within the appliance.

### Warning

Food needs to be packed in bags before putting into the refrigerator, and liquids need to be packed in bottles or capped containers to avoid the problem that the product design structure is not easy to clean.

**Hisense**

life reimagined