

Panasonic®

Wide Screen TV Operating Instructions

CT-30WX52

Model No.

CT-34WX52



For assistance, please call : 1-888-VIEW-PTV(843-9788)

or send e-mail to : consumerproducts@panasonic.com

or visit us at www.panasonic.com

(U.S.A)

For assistance, please call : 787-750-4300

or visit us at www.panasonic.com

(Puerto Rico)

For assistance, please call : 1-800-561-5505

or visit us at www.panasonic.ca

(Canada)

English

TQBC0385-1



The lightning flash with arrow-head within a triangle is intended to tell the user that parts inside the product are a risk of electric shock to persons.



The exclamation point within a triangle is intended to tell the user that important operating and servicing instructions are in the papers with the appliance.

WARNING: To reduce the risk of fire or electric shock, do not expose this apparatus to rain or moisture. Do not place liquid containers (flower vase, cups, cosmetics, etc.) above the set. (including on shelves above, etc.)

WARNING: 1) To prevent electric shock, do not remove cover. No user serviceable parts inside. Refer servicing to qualified service personnel.
2) Do not remove the grounding pin on the power plug. This apparatus is equipped with a three pin grounding-type power plug. This plug will only fit a grounding-type power outlet. This is a safety feature. If you are unable to insert the plug into the outlet, contact an electrician.
Do not defeat the purpose of the grounding plug.

Important Safety Instructions

- 1) Read these instructions.
All the safety and operating instructions should be read before the appliance is operated.
- 2) Keep these instructions.
The safety and operating instructions should be retained for future reference.
- 3) Heed all warnings.
All warnings on the appliance and in the operating instructions should be adhered to.
- 4) Follow all instructions.
All operating and use instructions should be followed.
- 5) Do not use this apparatus near water.
For example, near a bathtub, wash bowl, kitchen sink, or laundry tub, in a wet basement, or near a swimming pool, and the like.
- 6) Clean only with dry cloth.
Do not use liquid cleaners or aerosol cleaners. Use a dry cloth for cleaning.
- 7) Do not block any ventilation openings. Install in accordance with the manufacturer's instructions.
Slots and Openings in the cabinet are provided for ventilation and to ensure reliable operation of the product and to protect it from overheating. The openings should never be blocked by placing the product on a bed, sofa, rug, or other similar surface.
- 8) Do not install near any heat sources such as radiators, heat registers, stoves, or other apparatus (including amplifiers) that produce heat.
This product should not be placed in a built-in installation such as a bookcase or rack unless proper ventilation is provided or the manufacturer's instructions have been adhered to.
- 9) Do not defeat the safety purpose of the polarized or grounding-type plug. A polarized plug has two blades with one wider than the other. A grounding type plug has two blades and a third grounding prong. The wide blade or the third prong are provided for your safety. If the provided plug does not fit into your outlet, consult an electrician for replacement of the obsolete outlet.
- 10) Protect the power cord from being walked on or pinched particularly at plugs, convenience receptacles, and the point where they exit from the apparatus.
- 11) Only use attachments / accessories specified by the manufacturer.
- 12) Use only with the cart, stand, tripod, bracket, or table specified by the manufacturer, or sold with the apparatus. When a cart is used, use caution when moving the cart / apparatus combination to avoid injury from tip-over.
Quick stops, excessive force, and uneven surfaces may cause the appliance and cart combination to overturn.
- 13) Unplug this apparatus during lightning storms or when unused for long periods of time.
This will prevent damage to the product due to lightning and power-line surges.
- 14) Refer all servicing to qualified service personnel. Servicing is required when the apparatus has been damaged in any way, such as power-supply cord or plug is damaged, liquid has been spilled or objects have fallen into the apparatus, the apparatus has been exposed to rain or moisture, does not operate normally, or has been dropped.



CAUTION : This TV set is intended to be used with the following TV stand: model TY-S30WX52 for the CT-30WX52, and TY-S34WX52 for the CT-34WX52. Use with other stands may result in the TV set becoming unstable, possibly causing injury.

Dear Panasonic Customer

Welcome to the Panasonic family of customers. We hope that you will have many years of enjoyment from your new color television set.

To obtain maximum benefit from your set, please read these Instructions before making any adjustments, and retain them for future reference.

Retain your purchase receipt also, and record the model number and serial number of your set in the space provided on the back cover of these instructions.

Visit our Panasonic Web Site for USA : www.panasonic.com

for Puerto Rico : www.panasonic.com

for Canada : www.panasonic.ca

For assistance, please call : 1-888-VIEW-PTV(843-9788) or send e-mail to : consumerproducts@panasonic.com or visit us at www.panasonic.com (U.S.A)
For assistance, please call : 787-750-4300 or visit us at www.panasonic.com (Puerto Rico)
For assistance, please call : 1-800-561-5505 or visit us at www.panasonic.ca (Canada)

Note:

This product utilizes both a Cathode Ray Tube (CRT) and other components that contain lead. Disposal of these materials may be regulated in your community due to environmental considerations. For disposal or recycling information please contact your local authorities, or the Electronics Industries Alliance: <[http:// www.eiae.org](http://www.eiae.org).>

FCC CAUTION:

Pursuant to 47CFR, Part 15.21 of the FCC rules, any changes or modifications to this TV not expressly approved by Matsushita Electric Corporation of America could result in harmful interference and would void the user's authority to operate this device.

Table of Contents

Important Safety Instructions	3	COLOR TEMP (Temperature) / NATURAL COLOR / VIDEO / NR / 3D Y/C FILTER	31
Installation	6	COLOR MATRIX	32
Receiver Location	6	VM (Velocity Modulation)	32
Optional External Equipment	6	FREEZE	33
AC Power Supply Cord	6	CHANNEL SCAN	34
Safety Precaution	6	CAPTION	36
Remote Control Battery Installation	7	PRESET CAPTION	36
Cable Connection	8	MANUAL CAPTION	37
Connecting the Aerial cable to the RF In Terminal	8	INPUT LABEL	37
Connecting Headphones / Earphones	9	Selecting STEREO/SAP/MONO	38
Optional Equipment Connections	9	Audio Adjustment	39
Cable Box Connection	9	Selecting BASS / TREBLE / BALANCE / NORMAL	39
VCR Connection	10	AI SOUND / BBE	40
VCR and Cable Box Connection	12	SURROUND	40
Digital TV - Set-Top Box (DTV-STB) or DVD Connection ..	14	SPEAKERS	41
Amplifier Connection (TO AUDIO AMP)	14	Picture in Picture Operation	42
Program Out Connection (PROG OUT)	15	Split Screen	44
Front Control Panel	15	ASPECT Controls	46
Location of Controls	16	Cable TV	47
Illuminated Remote Control	16	TIMER	48
Power ON / OFF	18	CLOCK SET	48
Connecting the Plug to the Wall Outlet	18	SLEEP	49
How to Turn the Power On	18	TIMER1 and TIMER2	50
Menu Language Selection	18	LOCK Feature	52
VHF, UHF and CATV	19	V-CHIP Menu OPERATION	55
Roller Guide Menu Navigation	20	US. TV PROGRAMS	56
SET UP Operation	22	U.S. MOVIES	58
SET UP	22	Canadian English	59
MENU Languages	22	Canadian French	60
MODE Selection	23	Blocking Message	61
ANTENNA Selection	23	Operating peripheral equipment	
AUTO PROGRAM	24	using the remote control	62
MANUAL PROGRAM	24	Programming The Illuminated Remote Control	
AUTO POWER	25	Using Access Codes	62
CHAN BANNER	25	Programming Without A Code	
Closed Captions	26	(When the code is not known)	63
CC ON MUTE	26	Infrared Codes Index	64
CC MODE	27	Mode Operational Key Chart	67
Geomagnetic correction (Adjusting skewing of images) ..	28	Troubleshooting Chart	69
PICTURE Adjustment	29	Cleaning	70
PICTURE MODE	29	Specifications	71
COLOR / TINT / BRIGHTNESS / PICTURE / SHARPNESS / NORMAL	30		

Installation

Receiver Location

This unit is intended to be used with an optional stand or entertainment center. Consult your dealer for available options. Locate for comfortable viewing. Avoid placing where sunlight or other bright light (including reflections) will fall on the screen.

Use of some types of fluorescent lighting can reduce remote control transmitter range.

Adequate ventilation is essential to prevent internal component failure. Keep away from areas of excessive heat or moisture. To ensure optimum color purity do not position magnetic equipment (motors, fans, other speakers, etc.) nearby.

Optional External Equipment

The Video/Audio connection between components can be made with shielded video and audio cables. For best performance, video cables should utilize 75 ohm coaxial shielded wire. Cables are available from your dealer or electronic supply store. Before you purchase any cables, be sure you know what type of output and input connectors your various components require. Also determine the length of cable you will need.

AC Power Supply Cord

CAUTION: To prevent electric shock, match wide blade of plug to wide slot of AC outlet and fully insert. Do not use this (polarized) plug with a receptacle or other outlet unless the blade can be fully inserted to prevent blade exposure.

Safety Precaution

Please take safety precautions to prevent the unit from falling over.

The unit may fall over during earthquakes, or if someone stands on or shakes the TV.

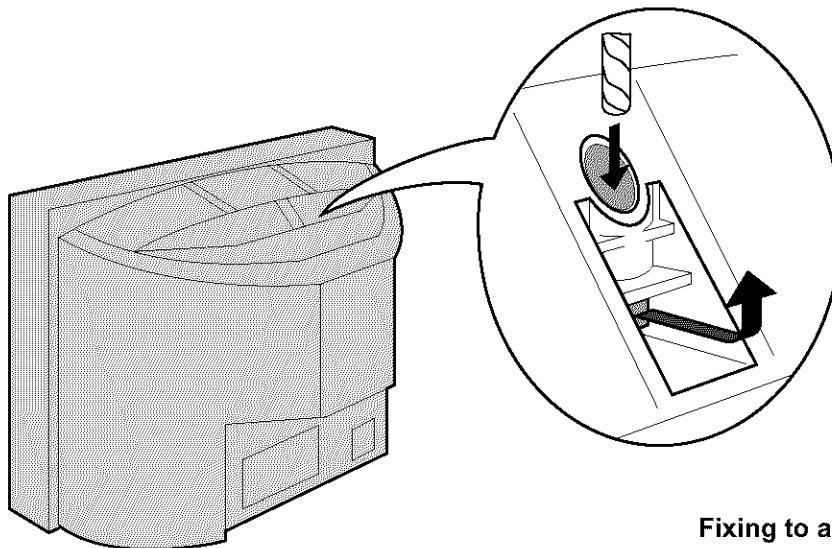

Fixing to a wall

Use a strong rope or a chain (not included) to fasten the TV firmly to a strong support such as a wall or pillar.

Remote Control Battery Installation

Requires two AA batteries.

1. Turn the Transmitter face down. Remove top cover by pressing down on marking and sliding cover off in the direction indicated.
2. Install the batteries as shown in the battery compartment. (Polarity + or – must match the markings in the compartment).
3. Replace the cover and slide in reverse until the lock snaps.

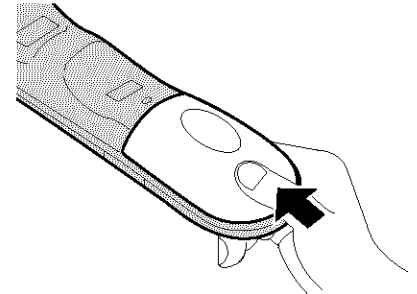
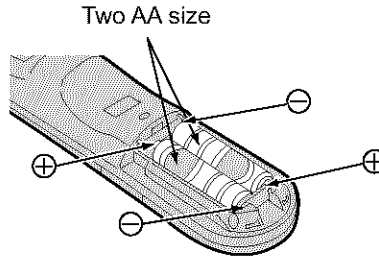
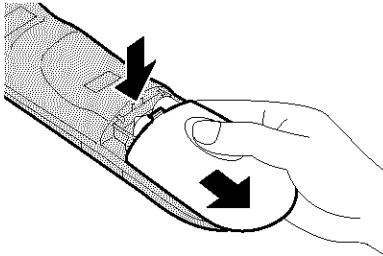

Helpful Hints:

For frequent remote control users, replace old batteries with alkaline batteries for longer life.

Note: In order to maximize the life of the batteries, the lighted buttons on the Remote Control can be turned OFF and ON by pressing R-TUNE and RECALL at the same time.

⚠ Precaution on battery use

Incorrect installation can cause battery leakage and corrosion that will damage the remote control transmitter.

Observe the following precautions:

1. Batteries should always be replaced as a pair. Always use new batteries when replacing the old set.
2. Do not combine a used battery with a new one.
3. Do not mix battery types (example: "Zinc Carbon" with "Alkaline").
4. Do not attempt to charge, short-circuit, disassemble, heat or burn used batteries.
5. Battery replacement is necessary when remote control acts sporadically or stops operating the TV set.

Helpful Hints:

Whenever you remove the batteries, **you may need to reset the remote control infrared codes.** We recommend that you record the code on page 64, prior to setting up the remote control.

Cable Connection

Connecting the Aerial cable to the RF In Terminal

Antenna Connection

- For proper reception of VHF/UHF channels, an external antenna is required. For best reception, an outdoor antenna is recommended. Antenna Mode must be set to TV.
- Incoming Cable from Home Antenna
Connect home antenna to ANT1 connection on back of television. Select TV mode and ANT1 in the SET UP menu. (Cable Mode is preset at the factory. Antenna users must change to TV mode and select ANT1 in the Set Up Menu under Prog chan.)

VHF Aerial UHF Aerial

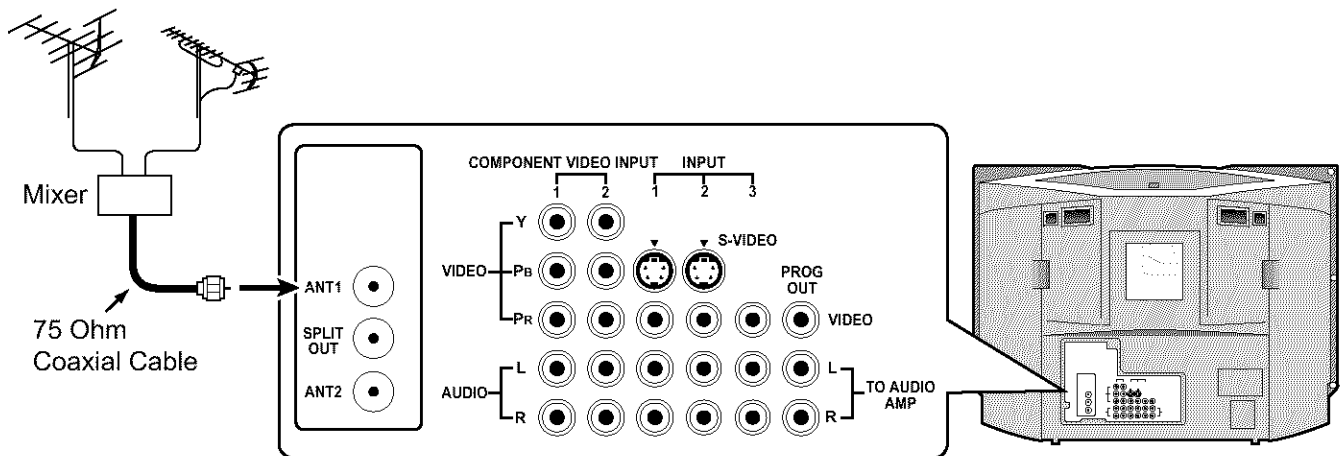

Incoming Cable from Home Antenna

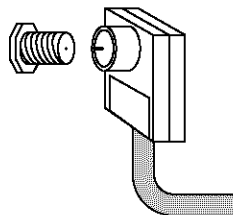

Incoming Cable from Cable Company

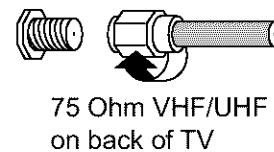

Note: Certain cable systems offset some channels to reduce interference or have Premium (scrambled) channels. A cable converter box is required for proper reception. Check with your local Cable company for its compatibility requirements.

Notes:

- (1) To obtain optimum quality picture and sound, an Aerial, the correct cable (75 Ohm coaxial) and the correct terminating plug are required.
- (2) If a communal Aerial system is used, you may require the correct connection cable and plug between the wall Aerial socket and your television receiver.
- (3) Your local Television Service Centre or Dealer may be able to assist you in obtaining the correct Aerial system for your particular area and the accessories required.
- (4) Any matters regarding Aerial installation, upgrading of existing systems or accessories required, and the costs incurred, are the responsibility of you, the Customer.

Connecting Headphones / Earphones

Connect headphones / earphones as follows.

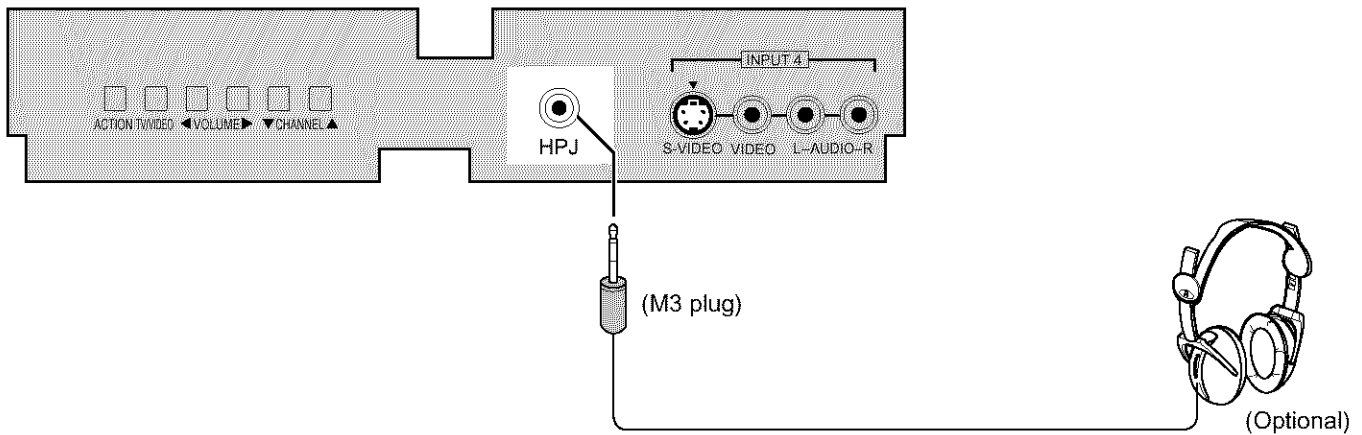

You can listen to sound from the headphone Jack.

Optional Equipment Connections

Cable Box Connection

Follow this diagram when connecting your television to a cable box only.

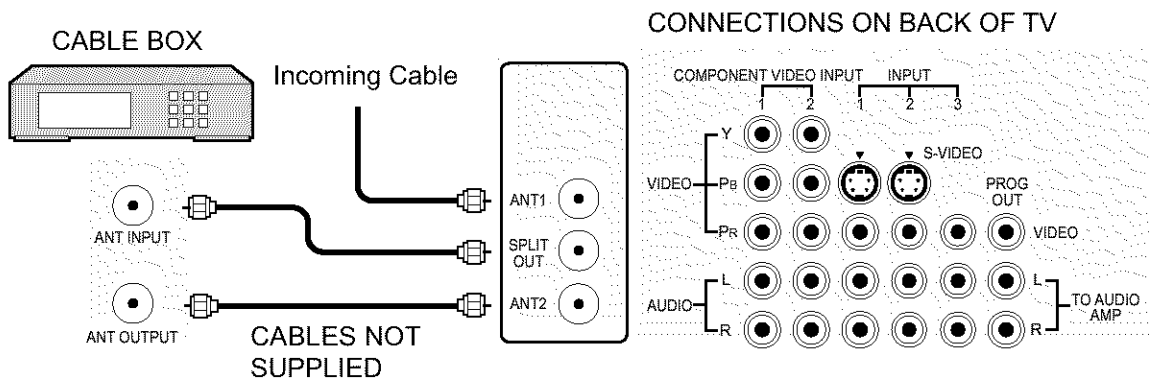

Note: The remote control must be programmed with supplied codes to operate the cable box (see page 66).

Viewing a premium (scrambled) cable channel

Procedure

1. Select ANT2 in the SET UP menu under Prog Chan (Program Channels).
2. Tune the television to Channel 3 or Channel 4.
3. Using the cable box, tune to the premium cable channel you would like to view.

Note:

To use special features such as Favorite Channels and Channel Captions, ANT1 must be selected in the SET UP menu under Prog Chan (see page 23).

Cable Connection

VCR Connection

Follow this diagram when connecting your television to a VCR only.

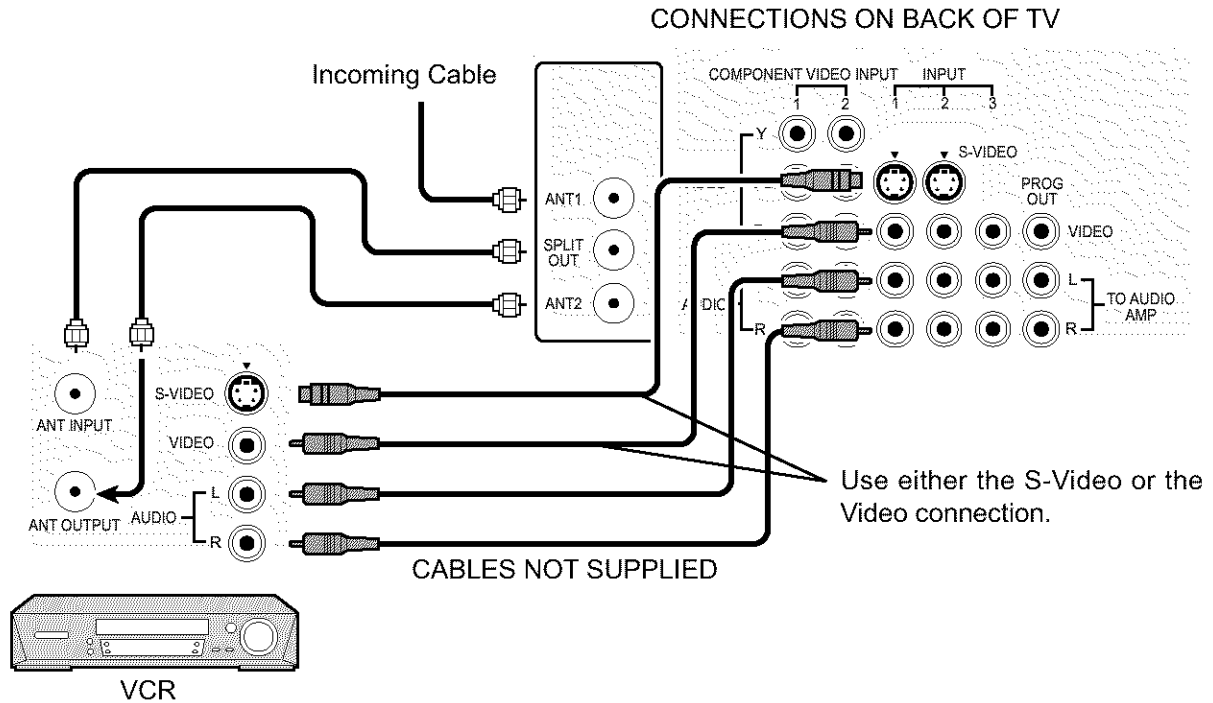

Note: The remote control must be programmed with supplied codes to operate the VCR (see page 64, 65).

Viewing a television program

Procedure

1. Select ANT1 in the SET UP menu under Prog Chan (Program Channels).
2. Tune the television to the television program you would like to view.

Viewing a video

Procedure

- Option A
 1. Press the TV/VIDEO button on the remote control to select the video input (VIDEO 1, VIDEO 2, etc.) connected to your VCR.
 2. Begin the video.
- Option B
 1. Select ANT2 in the SET UP menu under Prog Chan.
 2. Tune the television to Channel 3 or 4, depending on your VCR.
 3. Begin the video.

Recording a television program

Procedure

- Option A (Recording and viewing the same program)
 1. Select ANT2 in the SET UP menu under Prog Chan.
 2. Tune the television to Channel 3 or 4, depending on your VCR.
 3. Using the VCR, tune to the television program you would like to record.
 4. Begin recording.
- Option B (Recording one program while viewing another program)
 1. Select ANT1 in the SET UP menu under Prog Chan.
 2. Press the TV/VIDEO button on the remote control to select the video input (VIDEO 1, VIDEO 2, etc.) connected to your VCR.
 3. Using the VCR, tune to the television program you would like to record.
 4. Begin recording.
 5. Press the TV/VIDEO button on the remote control to switch back to TV mode.
 6. Tune the television to the program you would like to view.

Cable Connection

VCR and Cable Box Connection

Follow this diagram when connecting your television to both a VCR and a cable box.

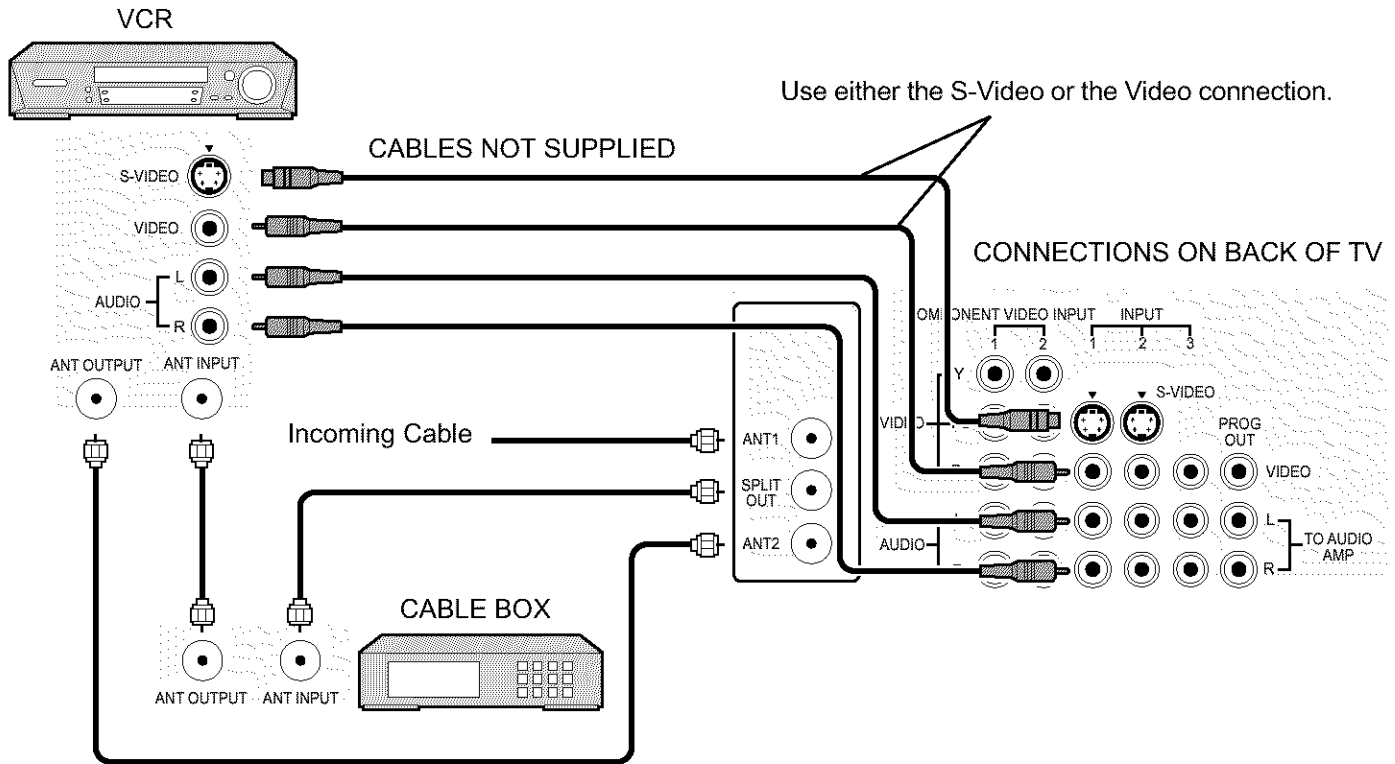

Note: The remote control must be programmed with supplied codes to operate the VCR and cable box (see page 64-66).

Viewing a premium (scrambled) cable channel

Procedure

1. Select ANT2 in the SET UP menu under Prog Chan (Program Channels).
2. Tune the television to Channel 3 or Channel 4.
3. Using the cable box, tune to the premium cable channel you would like to view.

Note: To use special features such as Favorite Channels and Channel Captions, ANT1 must be selected in the SET UP menu under Prog Chan (see page 23).

Recording a premium (scrambled) cable channel

Procedure

1. Select ANT2 in the SET UP menu under Prog Chan.
2. Press the TV/VIDEO button on the remote control to select the video input (VIDEO 1, VIDEO 2, etc.) connected to your VCR.
3. Turn the VCR ON.
4. Tune the VCR to Channel 3 or 4, depending on the switch setting on the back of VCR.
5. Using your cable box, tune to the premium cable channel you would like to record.
6. Begin recording.

Note: To view a different channel while recording:

- Select ANT1 in the SET UP menu under Prog Chan.
- Press the TV/VIDEO button on the remote control to TV mode.
- Tune the television to a program (except another premium cable channel).

Notes:

- (1) Similar connections are available at the INPUT 1, 2, 3, 4 input terminals.
Input 4 is located on the front of the unit.
Select the desired VIDEO input position by pressing the TV/VIDEO button. (See page 17)
- (2) When connecting video cables, priority is given to the S-Video cable when the S-Video input terminal and the video input terminal are connected at the same time.

Cable Connection

Digital TV - Set-Top Box (DTV-STB) or DVD Connection

This television is capable of displaying 1080i and 480p DTV signals when connected to a DTV Tuner set-top-box (STB). In order to view DTV programming, the STB must be connected to the component video inputs (Y, P_B, P_R) of the television. A DTV signal must be available in your area. Select the output of the STB to either 1080i or 480p.

This television also utilizes a progressive scan doubler, which de-interlaces the NTSC signal and progressively scans the image. This allows you to sit close to the TV and not see the thin black horizontal lines (venetian blind effect) associated with interlaced TV pictures.

Use this diagram to connect the Panasonic DTV-STB (Digital TV-Set-Top Box) or DVD Player to the back of your TV.

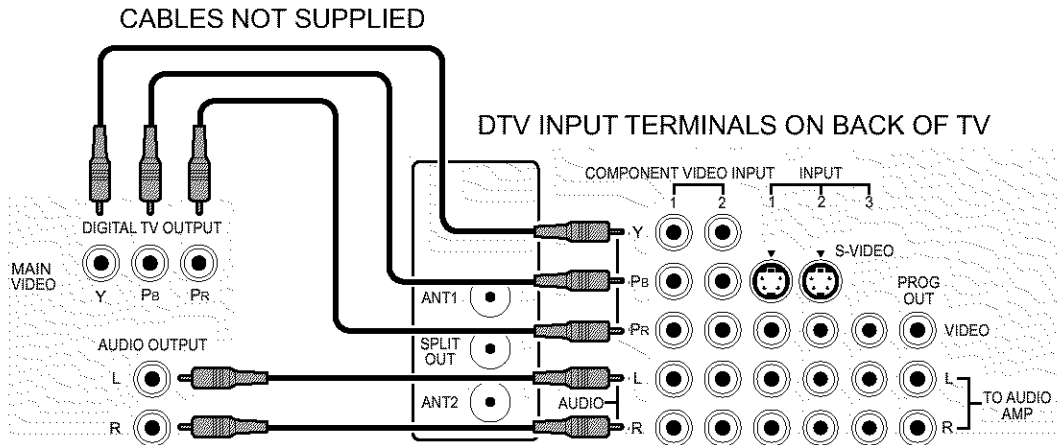

Note:

There are 2 sets of three video inputs, Y, P_B, and P_R. Separate component color inputs provide luminance and color separation. Use the L (left) and R (right) audio inputs.

Amplifier Connection (TO AUDIO AMP)

To listen through a separate stereo system, connect an external audio amplifier TO AUDIO AMP inputs on back of television.

Note: TO AUDIO AMP terminals cannot be connected directly to external speakers.

Audio Adjustments

Procedure

1. Select SPEAKERS ON located in the onscreen AUDIO menu.
2. Set amplifier volume to minimum.
3. Adjust television volume to desired level.
4. Adjust amplifier volume to match the television.
5. Select SPEAKERS OFF & VARIABLE AUDIO OUT from AUDIO menu.
6. Volume, mute, bass, treble and balance are now controlled through the television.

Select SPEAKERS OFF & FIXED AUDIO OUT to control audio functions through the external amplifier.

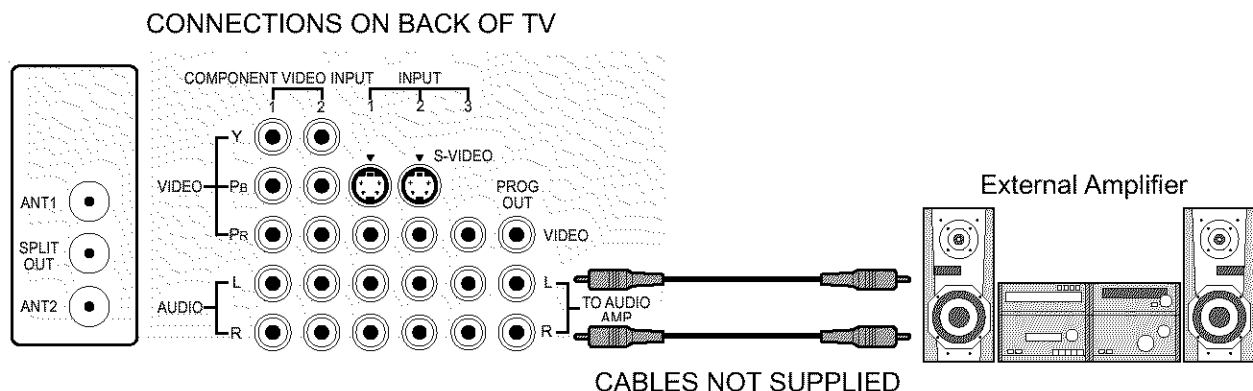

Program Out Connection (PROG OUT)

To use the television audio and video with optional equipment, connect the PROG OUT and TO AUDIO AMP connections on the back of the television.

CONNECTIONS ON BACK OF TV

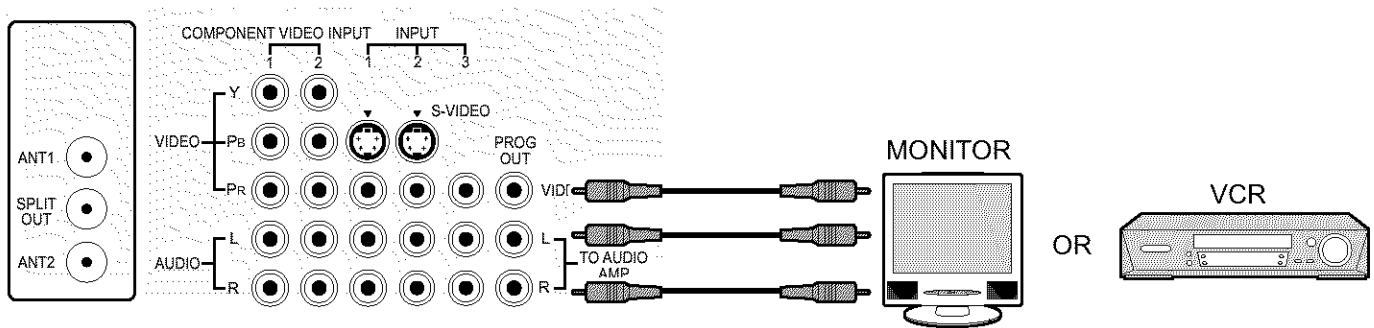

Procedure

1. Connect optional equipment to PROG OUT and TO AUDIO AMP terminals.
2. PROG OUT terminal display is the same as onscreen display.

See optional equipment manual for further instructions for recording and monitoring.

Front Control Panel

Push to open the front panel of the television to use the TV without remote control or to use the Audio/Video input jacks for optional equipment.

Press  to select VIDEO 4 input mode.

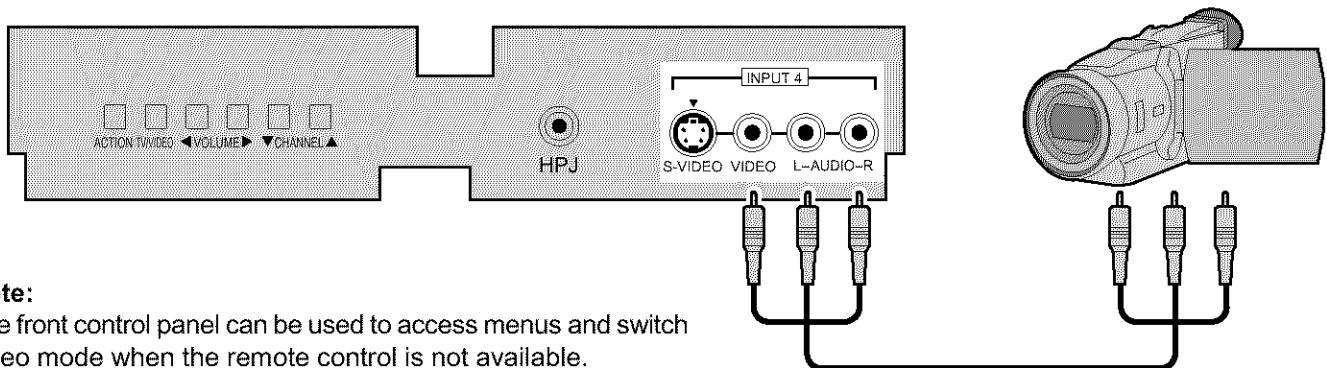

Note:

The front control panel can be used to access menus and switch video mode when the remote control is not available.

A second VCR, video disc player, video game equipment and DSS equipment can also be connected to the video inputs. See the optional equipment manual for details.

Procedure

1. Connect equipment to front Audio/Video input jacks.
2. Operate optional equipment as instructed in equipment manual.

Note:

The S-VIDEO connection provides higher quality picture. It overrides other VIDEO connections. Use INPUT 4, AUDIO L and R with S-VIDEO connection.

Location of Controls

Illuminated Remote Control

Power button

Press to turn the TV ON or OFF (See page 18).

Note: The TV's power cord must first be plugged into the wall outlet and then turned on at the POWER switch (standby mode).

ASPECT button

Change of screen size (See page 46).

→ 4 : 3 → ZOOM → FULL → JUST

MUTE button

Press this button to mute the sound, press again to cancel the mute.

Mode Selection buttons

Selects the operation mode for the remote control. (See page 62)

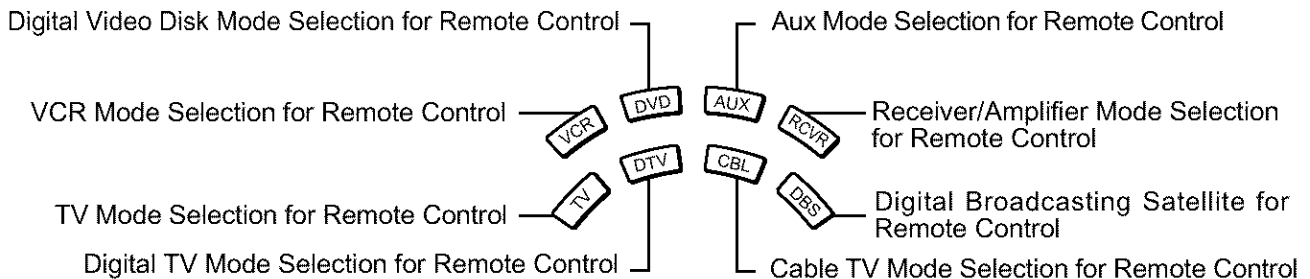

R-TUNE



R-TUNE button

Switches to previously viewed channel or video mode.

Operation of other Device

Buttons	PIP MIN REW	PIP MAX FF	PLAY	PAUSE	STOP
Device					
TV	PIP Minimize/Maximize		—	—	—
VCR	VCR REW/FF		PLAY	Pause	STOP
CABLE/DBS	—		—	—	—
DVD/LD/CD	Skip Search REW/FF		PLAY	Pause	STOP
RCVR	Surround —/+		—	—	—

Buttons	REC	FREEZE TV/VCR	PIP CH VCR CH	SEARCH OPEN/CLOSE
Device				
TV	—	PIP or SPLIT FREZE	PIP or SPLIT CH up/down	PIP Search
VCR	VCR RECORD	TV/VCR Switch	VCR CH up/down	—
CABLE/DBS	DBS RECORD	TV/DBS Switch	TV/DBS CH up/down	—
DVD/LD/CD	—	—	—	OPEN/CLOSE
RCVR	—	—	—	—

TV/VIDEO button
The input mode changes each time this button is pressed.

TV → COMPONENT 1 → COMPONENT 2
VIDEO 4 ← VIDEO 3 ← VIDEO 2 ← VIDEO 1

SAP button
Selects Audio mode (See page 38).

STEREO → SAP → MONO

Lights the remote control buttons.
The selected button blinks when lit.

Turning the remote control illumination ON and OFF .

R-TUNE Remote control illumination can be turned ON and OFF by pressing the RECALL button while pressing the R-TUNE button.

Changes to the next channel up
Moves cursor upward during menu mode.

Reduces volume
Moves cursor to the left during menu mode.

Increases volume
Moves cursor to the right during menu mode.

Displays menu
Press to access DTV, DBS or DVD menus. During TV mode press to select BBE ON or BBE OFF.

Changes to the next channel down
Moves cursor downward during menu mode.

Page up/down for DBS, skip +/- for DVD & CD.

GUIDE button for DBS.

Returns to normal viewing from the MENU screen. Previous item in MENU.

Direct program number selection buttons

PROG dash button
Program dash channel numbers for DTV and DBS.

Swap pictures in Split Screen and Picture in Picture operation
(See page 42, 45).

Move PIP frame in Picture in Picture Operation
(See page 43).

Split Screen (see page 44)

Picture in Picture Operation (see page 42)

Power ON / OFF

Connecting the Plug to the Wall Outlet

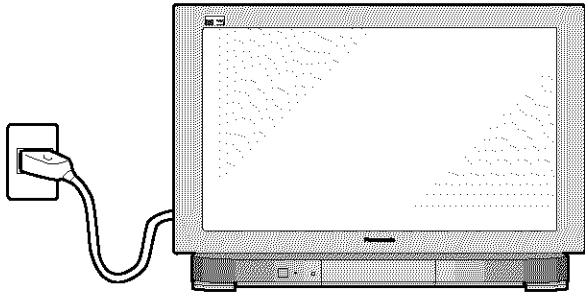

Note:

Main plug types vary between countries. The power plug shown at left may, therefore, not be the type fitted to your set.

How to Turn the Power On

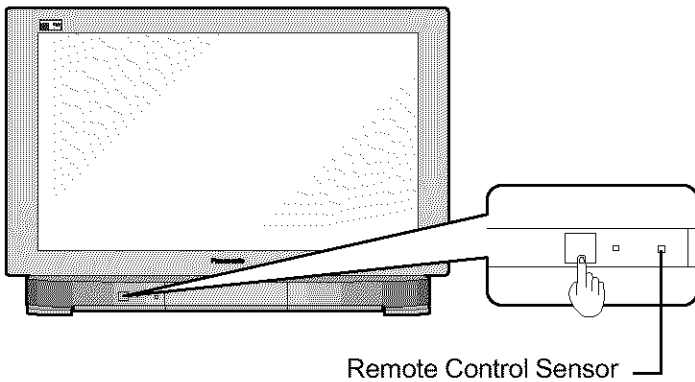

Press the POWER switch on the TV to turn the set on.
POWER-ON: Red
When the set is on press the POWER switch on the TV to turn the set off.
STANDBY: No light

Example: The screen below is displayed for a while after the TV is turned on. (setting condition is an example.)

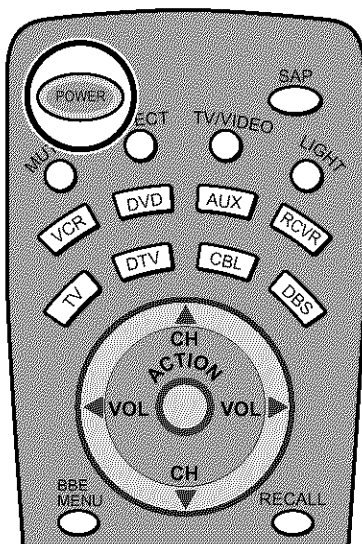
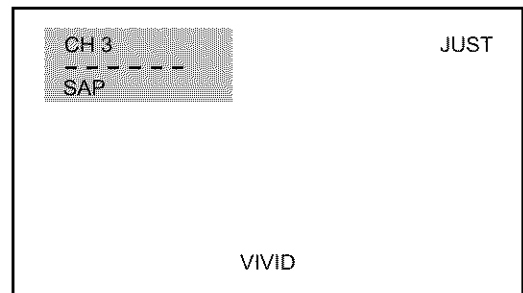

Press the POWER button on the remote control to turn the TV on: Red
Press the POWER button on the remote control to turn the TV off: No light (standby)

Note:

The TV will still consume some power as long as the power cord is still inserted into the wall outlet.

Menu Language Selection

In SET UP Menu, Select IDIOMA/LANGUE to change menu language to ENGLISH, ESPAÑOL (Spanish) or FRANÇAIS (French). (refer to page 22)

VHF, UHF and CATV

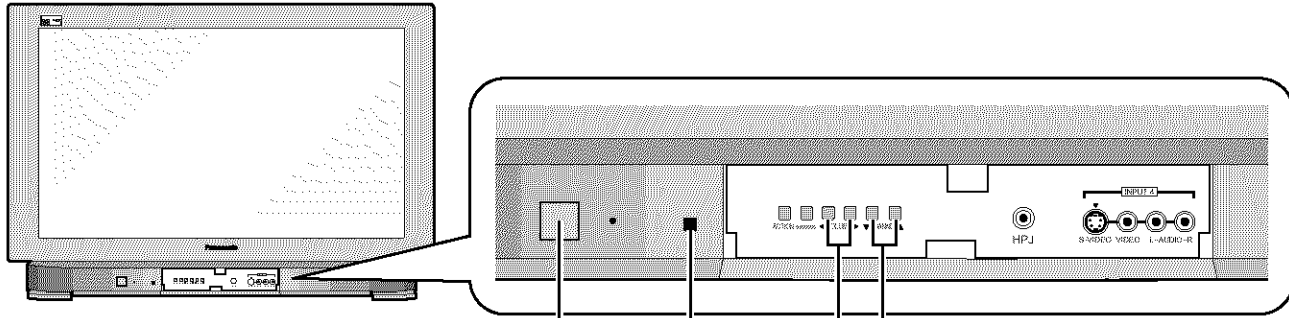

Power switch

Operation can be done from the TV set.

- Channel selectors
- Volume adjusters

Remote control sensor

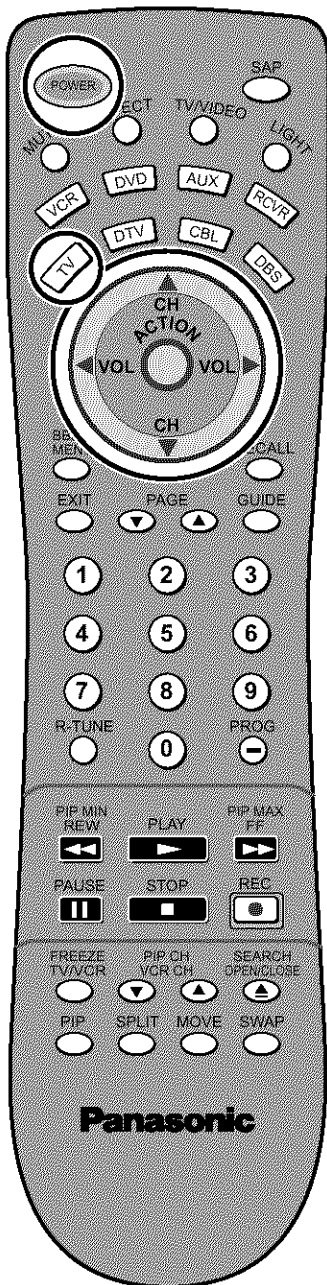

1



Press  to operate the TV set with the remote control.

2



Press to turn the TV on (See page 18).

3

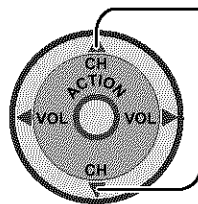

Press to select the desired channel.

4

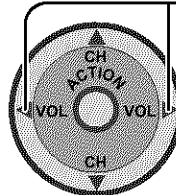

Select the desired volume level.

Notes:

- (1) The channel number and volume level remain the same even after the TV is turned off.
- (2) Power consumption and howling of sound can be reduced if the volume level is lowered.

Roller Guide Menu Navigation

1 Press to display the roller guide menu.

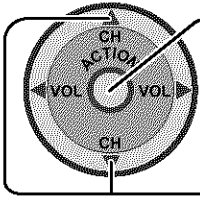

Press to rotate to desired icon.

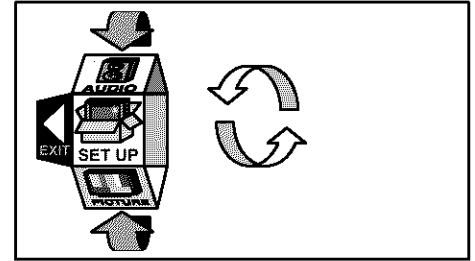

2 Press to display the main menu and submenu field.

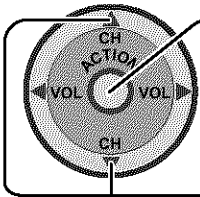

Press to select main menu feature.

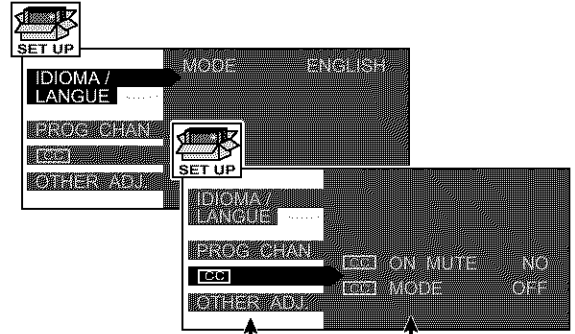

Main menu field

Submenu field

3 Press to enter submenu field.

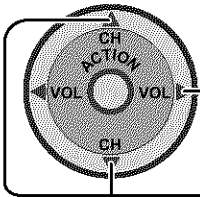

Press to select desired submenu feature.

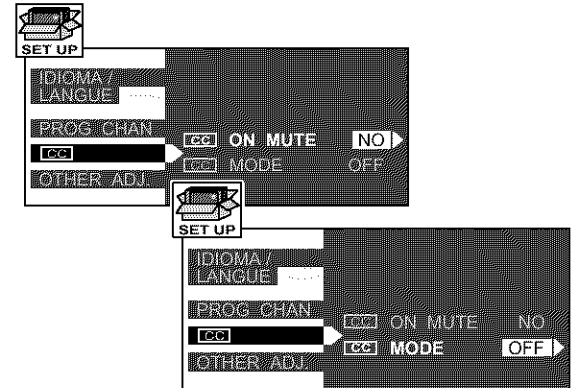

4 Press to select or adjust.

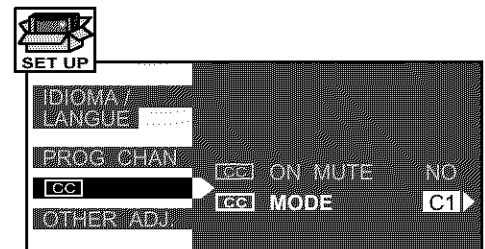
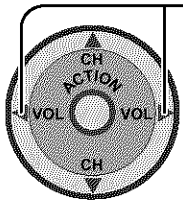

5 Press twice to return to the roller guide.

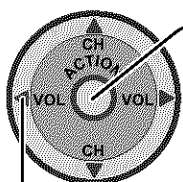



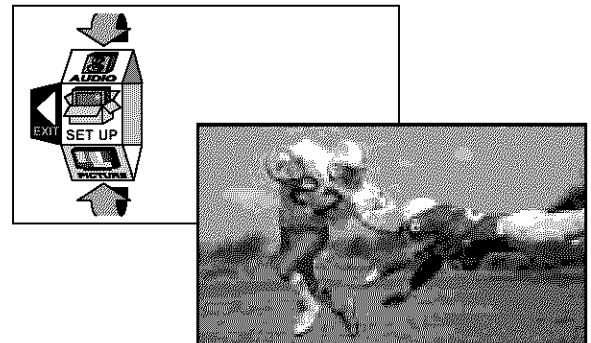







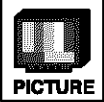









Press to exit roller guide.
This returns the set to the normal viewing.



NORMAL PICTURE

Roller Guide Menu Navigation

 <p>SET UP</p>	 <p>SET UP</p> <p>IDIOMA / LANGUE → MODE → ENGLISH →</p> <p>PROG_CHAN</p> <p>OTHER_ADJ</p>	 <p>SET UP</p> <p>IDIOMA / LANGUE</p> <p>PROG_CHAN → MODE → CABLE →</p> <p>ANTENNA → ANT1 →</p> <p>AUTO PROGRAM</p> <p>MANUAL PROGRAM →</p>	
 <p>PICTURE</p>	 <p>PICTURE</p> <p>VIDEO_ADJ. → PIC MODE → STANDARD →</p> <p>COLOR</p> <p>TINT</p> <p>BRIGHTNESS</p> <p>PICTURE</p> <p>SHARPNESS</p> <p>NORMAL</p>	 <p>PICTURE</p> <p>VIDEO_ADJ. → COLOR TEMP → NORMAL →</p> <p>NATURAL COLOR → ON →</p> <p>VIDEO NR → OFF →</p> <p>3D Y / C FILTER → ON →</p>	 <p>PICTURE</p> <p>VIDEO_ADJ.</p> <p>OTHER_ADJ1 → COLOR MATRIX → SD →</p> <p>VM → ON →</p> <p>FREEZE → SPLIT →</p>
 <p>53¹ CHANNELS</p>	 <p>53¹ CHANNELS</p> <p>FAVORITES → CHANNEL SCAN → FAV →</p> <p>ENTER CHANNEL → 15 →</p> <p>FAVORITE CHANNELS</p> <p>2 5 8 10</p> <p>15 18 25</p>	 <p>53¹ CHANNELS</p> <p>FAVORITES</p> <p>CAPTION → PRESET CAPTION →</p> <p>MANUAL CAPTION →</p> <p>INPUT LABEL →</p>	
 <p>LOCK</p>	 <p>LOCK</p> <p>MODE → LOCK SET → CHANNEL →</p> <p>BLOCK PROGRAMS → U.S. MOVIES →</p> <p>STATUS → ON →</p> <p>CHANGE CODE →</p>	 <p>LOCK</p> <p>MODE</p> <p>HOW LONG ? → 12HOURS →</p>	
 <p>TIMER</p>	 <p>TIMER</p> <p>CLOCK SET → TIME → 12:00 AM →</p> <p>DAY → SUN →</p> <p>SLEEP</p> <p>TIMER1</p> <p>TIMER2</p>	 <p>TIMER</p> <p>CLOCK SET → HOW LONG ? → 30 →</p> <p>SLEEP</p> <p>TIMER1</p> <p>TIMER2</p>	 <p>TIMER</p> <p>CLOCK SET → DAY → DAYLY →</p> <p>ON TIME → 12:00 PM →</p> <p>OFF TIME → 13:00 PM →</p> <p>ENTER CHANNEL → 5 →</p> <p>SET → YES →</p>
 <p>AUDIO</p>	 <p>AUDIO</p> <p>MODE → STEREO → SAP → MONO →</p> <p>BASS</p> <p>TREBLE</p> <p>BALANCE</p> <p>NORMAL</p>	 <p>AUDIO</p> <p>AUDIO_ADJ. → AI SOUND → ON →</p> <p>OTHER_ADJ. → BBE → ON →</p> <p>SURROUND</p> <p>SPEAKERS</p>	 <p>AUDIO</p> <p>AUDIO_ADJ.</p> <p>OTHER_ADJ. → MODE → ON →</p> <p>SURROUND</p> <p>SPEAKERS → ON →</p>

SET UP Operation

SET UP

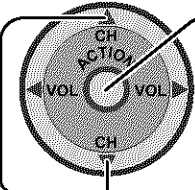
- 1  Press to display the roller guide menu.
Press to rotate to SET UP.

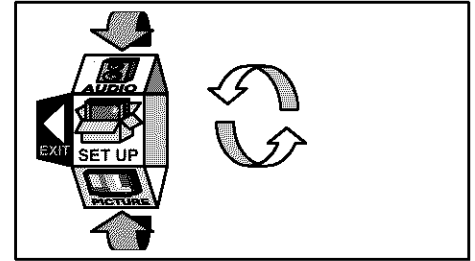

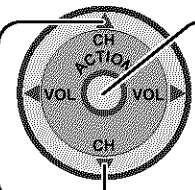
- 2  Press to display SET UP.
Press to select the main menu.

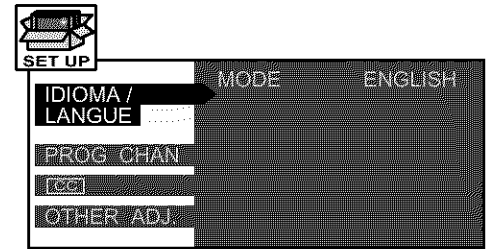

Proceed to each adjustment item of the selected main menu.

3 To end Adjustment:

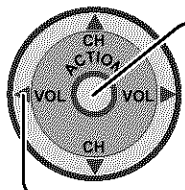
-  Press twice to return to the roller guide.
Press to exit roller guide.
This returns the set to normal viewing.

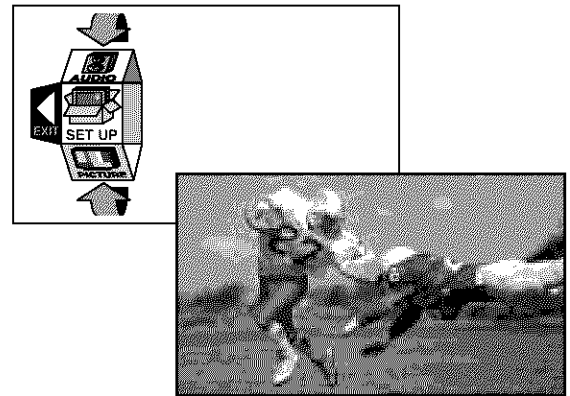

NORMAL PICTURE

MENU Languages

In SET UP Menu, select IDIOMA / LANGUE to change menu language to ENGLISH, ESPAÑOL (Spanish) or FRANÇAIS (French).

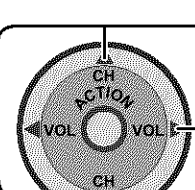
- 1  Press to select IDIOMA / LANGUE.
Press to enter submenu field.

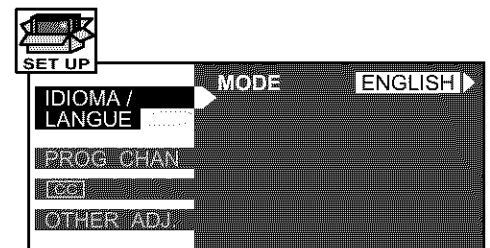

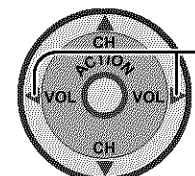
- 2  Press to select ENGLISH, SPANISH or FRENCH.
- ENGLISH ↔ ESPAÑOL ↔ FRANÇAIS ←

MODE Selection

To select either CABLE or TV.

1 In SET UP menu press to select PROG CHAN.

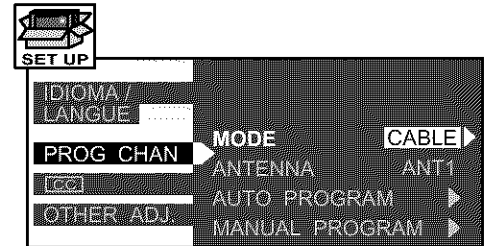
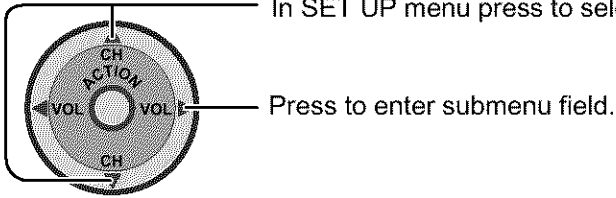

2 Press to select MODE.

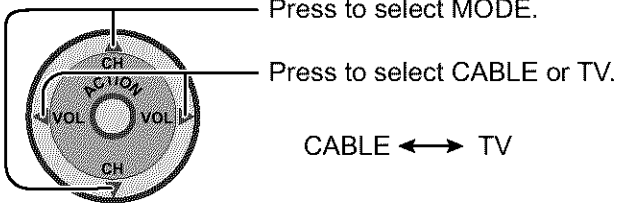

ANTENNA Selection

To select either ANT1 or ANT2.

1 In SET UP menu press to select PROG CHAN.

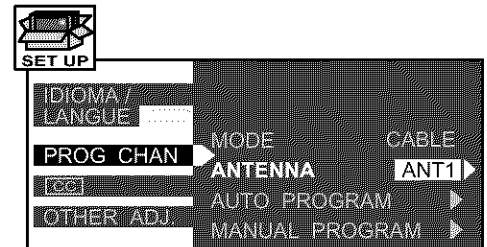
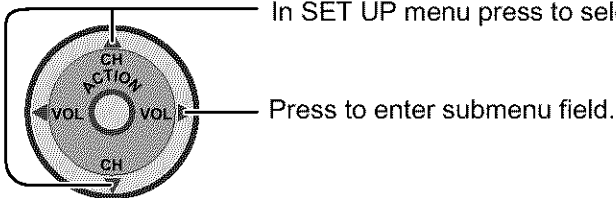

2 Press to select ANTENNA.

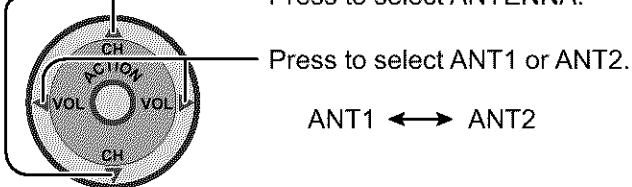

SET UP Operation

AUTO PROGRAM

To automatically program all channels with a signal.

1 In SET UP menu press to select PROG CHAN.

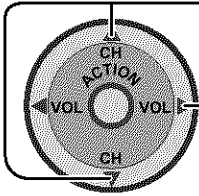

Press to enter submenu field.

2 Press to select AUTO PROGRAM.

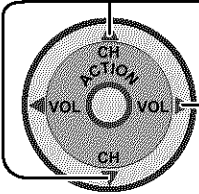

Press to start AUTO PROGRAM.

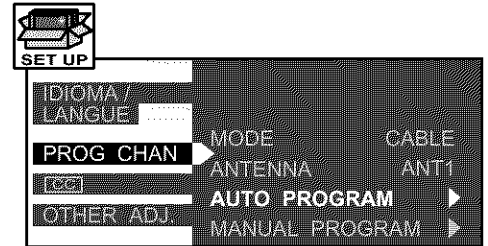

MANUAL PROGRAM

To manually add or delete channels.

1 In SET UP menu press to select PROG CHAN.

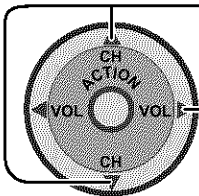

Press to enter submenu field.

2 Press to select MANUAL PROGRAM.

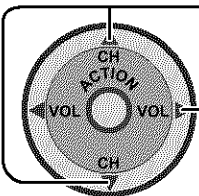

Press to display next menu.

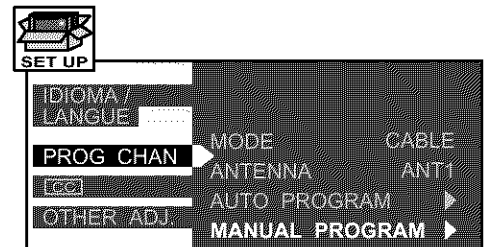

3 Use remote numeric keypad to select desired channel.

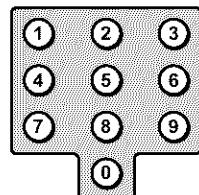

4 Press to ADD or DELETE the channel.

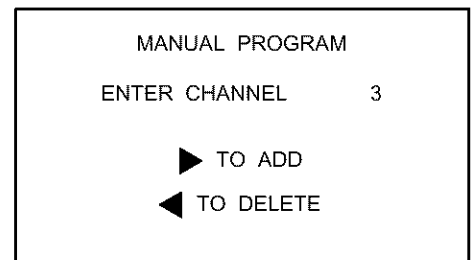
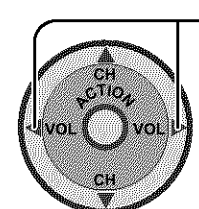

AUTO POWER

Select SET to power up the TV at the same time as the cable box or other components or select OFF.

1 In SET UP menu press to select OTHER ADJ.

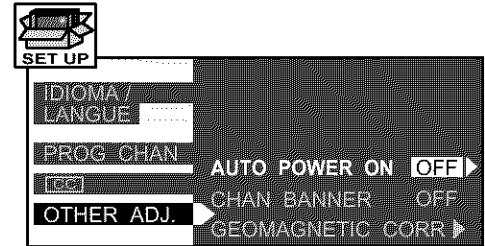
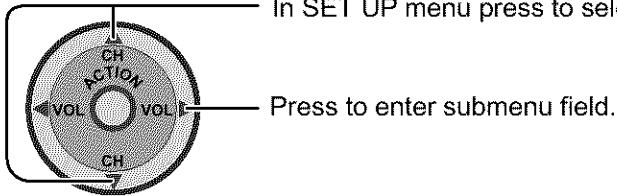

2 Press to select AUTO POWER.

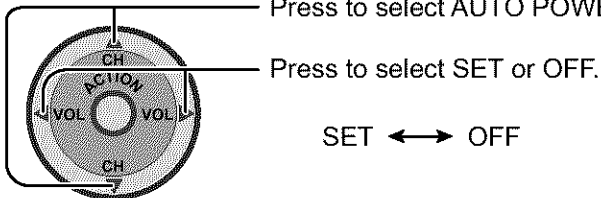

CHAN BANNER

Select ON to display the CHANNEL BANNER on the screen or select OFF.

1 In SET UP menu press to select OTHER ADJ.

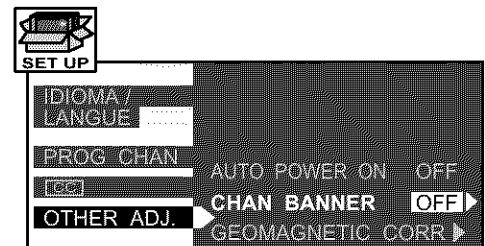
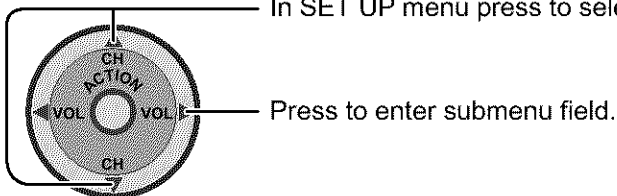

2 Press to select CHAN BANNER.

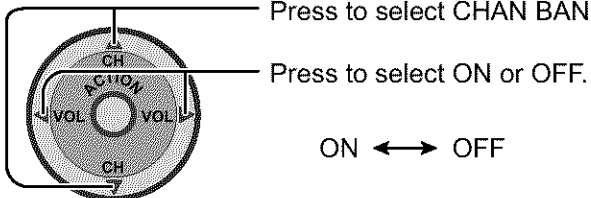

Closed Captions

This receiver has a built in decoder that provides a visual depiction of the audio portion of a television program in the form of written words across the screen (white or colored letters on a black background). It allows the viewer to read the dialogue of a television program or other information.

1

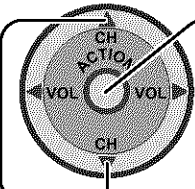

Press to display the roller guide menu.

Press to rotate to SET UP.

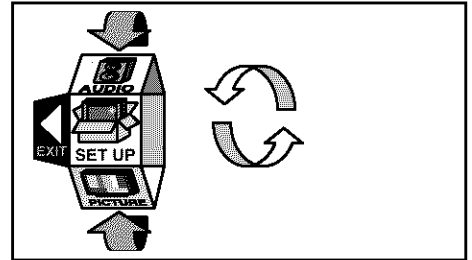

2

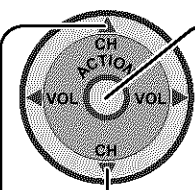

Press to display SET UP.

Press to select **CC**.

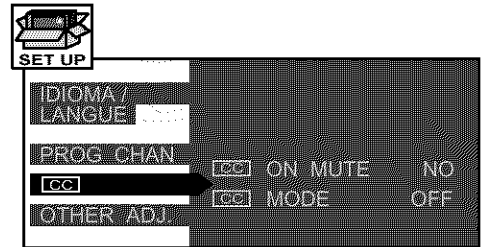

3

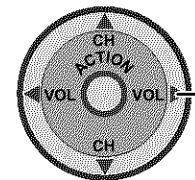

Press to enter submenu field.

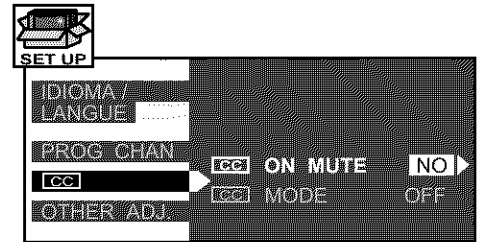

CC ON MUTE

Activates the On-Screen Closed Caption feature, when the MUTE button on the Remote Control is pressed. To deactivate, press the MUTE button again.

Note:

This feature functions when the Closed Caption Mode is in the "OFF" position. The program being viewed must be broadcast with Closed Caption.

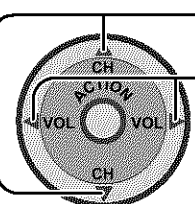

In the submenu field press to select **CC** ON MUTE.

Press to select from the following:

→ NO (OFF) ↔ C1 ↔ C2 ↔ C3 ↔ C4 ←

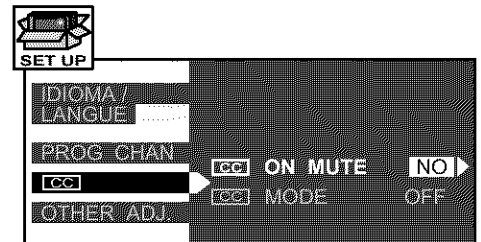

CC MODE

Activates the On-Screen Closed Caption feature. When activated this feature will remain on until OFF is selected in this menu.

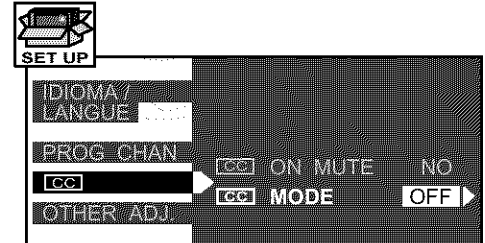
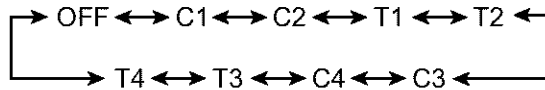
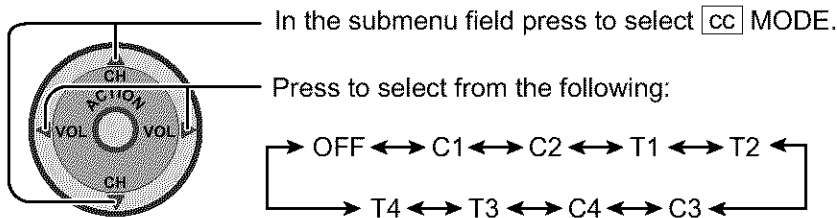

- **CAPTION OFF** - Recommended mode when Closed Caption is not being used.
- **CAPTION C1** - For video related information that can be displayed (up to 4 lines of script strategically placed on the television screen so that it does not obstruct relevant parts of the picture).
- **CAPTION C2** - Another mode used for video related information.
- **TEXT T1** - Blanks out a large portion of the picture on the television screen, and displays program guide or any other information currently being transmitted.
- **TEXT T2** - Another mode which displays information and blanks out a large portion of the picture on the television screen.
- **CAPTION C3** - Another mode used for video related information.
- **CAPTION C4** - Another mode used for video related information.
- **TEXT T3** - Another mode which displays information and blanks out a large portion of the picture on the television screen.
- **TEXT T4** - Another mode which displays information and blanks out a large portion of the picture on the television screen.

Notes:

(1) Recommended menu Set Up for Closed Caption when using Mute Button.

CC ON MUTE: C1
CC MODE: OFF

- (2) The setting for CC ON MUTE is valid only when the CC MODE is OFF. CC MODE set to ON will override CC ON MUTE. This menu cannot be selected when the MAIN picture is displaying a COMPONENT VIDEO INPUT of 480i or more.
- (3) When aspect is ZOOM, Closed Caption cannot be used.

4 To end Adjustment:

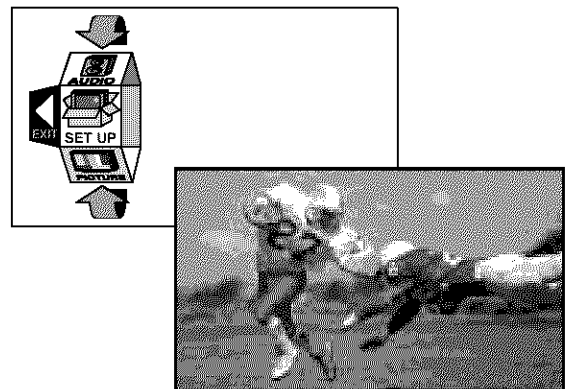
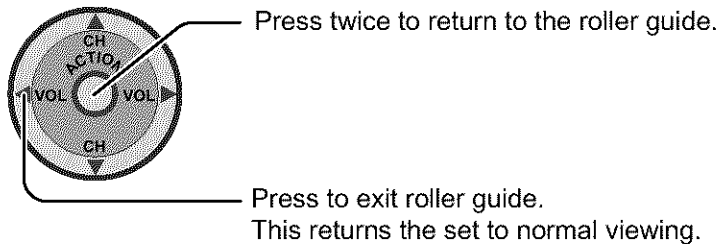

NORMAL PICTURE

Geomagnetic correction (Adjusting skewing of images)

GEOMAGNETIC CORR (CORRECTION) adjusts to erase the discoloration of the picture due to earth's magnetic field in the area.

This correction is made when moving the TV set or when image is slightly skewed.

1

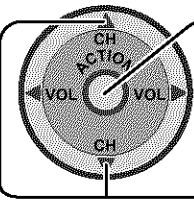

Press to display the roller guide menu.

Press to rotate to SET UP.

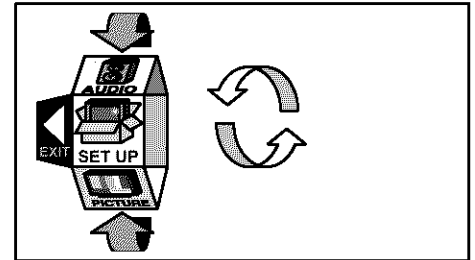

2

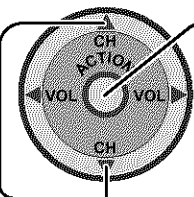

Press to display SET UP.

Press to select OTHER ADJ.

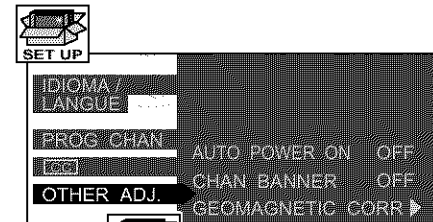

3

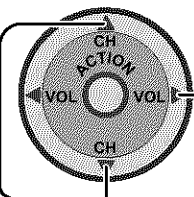

Press to enter submenu field.

Press to select GEOMAGNETIC CORR.

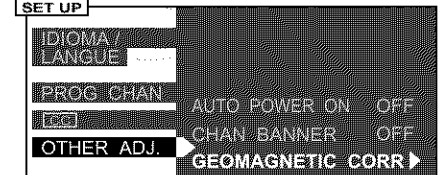

4

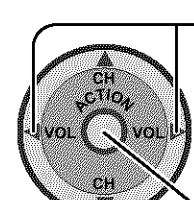

Adjust the vertical bar left or right until the discoloration disappears.

Press to exit GEOMAGNETIC CORRECTION.
"DEGAUSSING" will be displayed for three seconds.

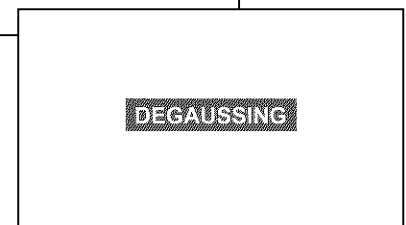
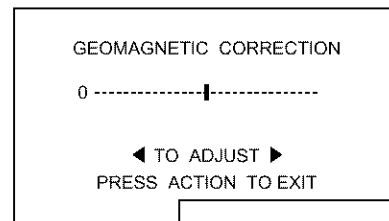

5 To end Adjustment:

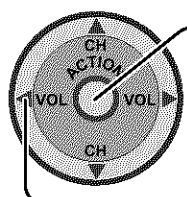

Press twice to return to the roller guide.

Press to exit roller guide.
This returns the set to normal viewing.

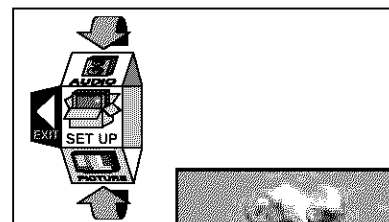

NORMAL PICTURE

PICTURE Adjustment

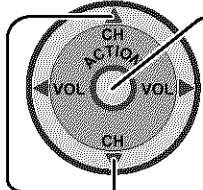
1  Press to display the roller guide menu.
Press to rotate to PICTURE.

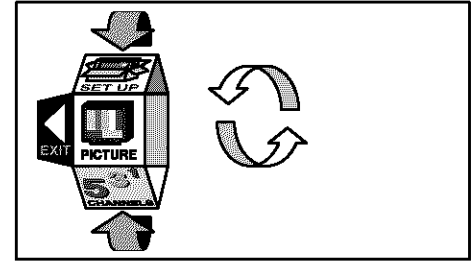

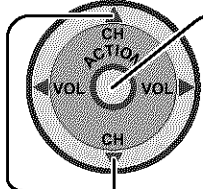
2  Press to display PICTURE menu.
Press to select the main menu.

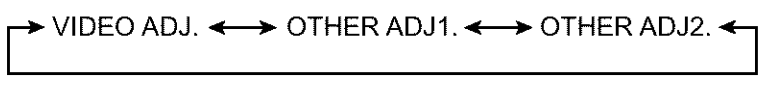
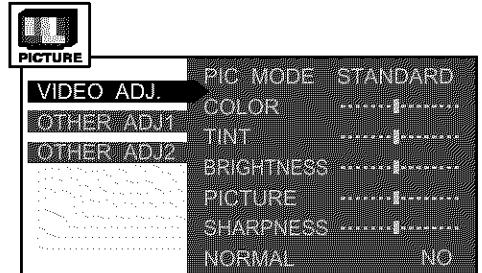

↓
Proceed to each adjustment item of the selected main menu.

3 To end Adjustment:

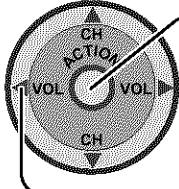
 Press twice to return to the roller guide.
Press to exit roller guide.
This returns the set to normal viewing.

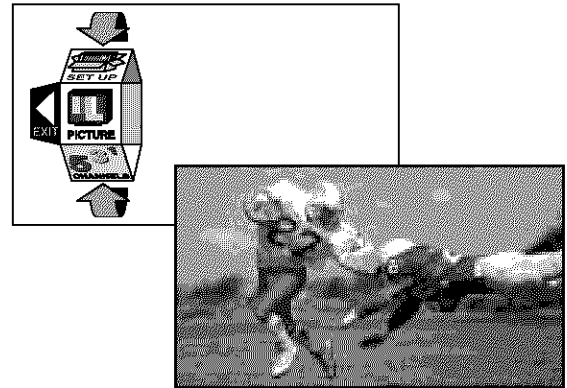

NORMAL PICTURE

PICTURE MODE

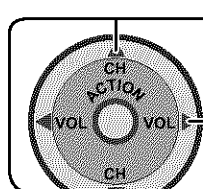
1  In PICTURE menu press to select VIDEO ADJ..
Press to enter submenu field.

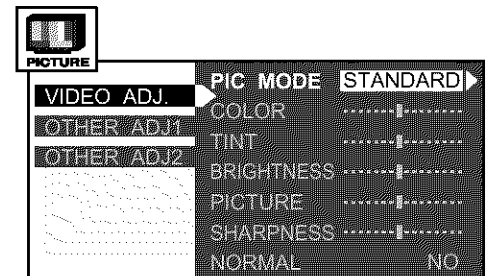

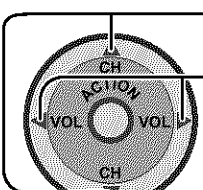
2  In VIDEO ADJ. submenu field press to select PIC MODE.
Press to select your desired PICTURE MODE.

VIVID ↔ STANDARD ↔ CINEMA ↔

PICTURE Adjustment

COLOR / TINT / BRIGHTNESS / PICTURE / SHARPNESS / NORMAL

1 In PICTURE menu press to select VIDEO ADJ..

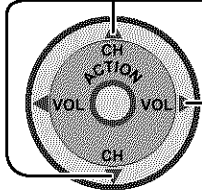

Press to enter submenu field.

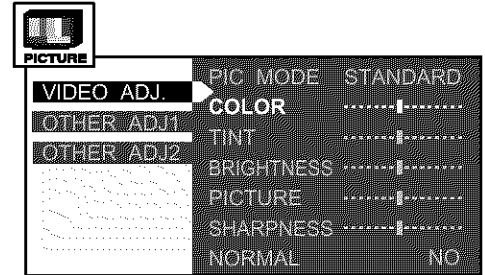

2 In VIDEO ADJ. submenu field press to select each submenu (COLOR / TINT / BRIGHTNESS / PICTURE / SHARPNESS / NORMAL).

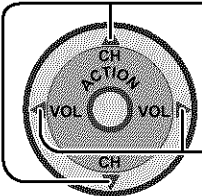

Press to adjust the desired level by looking at the picture behind the menu.

Item	Function
COLOR	Adjusts desired color intensity.
TINT	Adjusts natural flesh tones.
BRIGHTNESS	Adjusts dark areas of picture.
PICTURE	Adjusts white areas of picture.
SHARPNESS	Adjusts clarity of outline detail.
NORMAL	Resets all picture adjustments to factory default settings.

COLOR TEMP (Temperature) / NATURAL COLOR / VIDEO / NR / 3D Y/C FILTER

1 In PICTURE menu press to select OTHER ADJ1.

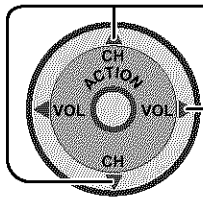

Press to enter submenu field.

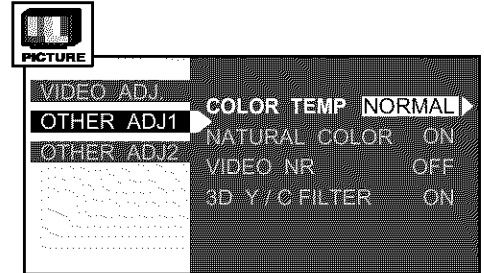

2 In OTHER ADJ1 submenu field press to select each submenu (COLOR TEMP / NATURAL COLOR / VIDEO NR / 3D Y/C FILTER).

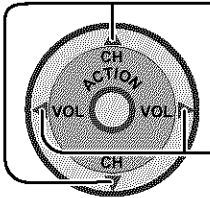

Press to adjust the desired level by looking at the picture behind the menu.

Item	Mode	Explanations
COLOR TEMP (temperature)		To increase or decrease WARM (red) and COOL (blue) colors to suit personal preferences.
NATURAL COLOR	ON ↔ OFF	To increase the color reproduction range with natural color gradation and highly delicate hues.
VIDEO NR	ON ↔ OFF	Reduces noise in the channel, commonly called snow. Remains off when receiving a strong signal.
3D Y/C FILTER	ON ↔ OFF	Minimizes noise and cross color in the picture.

PICTURE Adjustment

COLOR MATRIX

Displays input signals (480p signals) in a natural color from digital equipment adaptors connected to COMPONENT VIDEO INPUT (Y, Pb/Cb ,Pr/Cr input terminals).

Select HD or SD to automatically adjust color parameters for HD (high definition) and SD (standard definition).

1 In PICTURE menu press to select OTHER ADJ2.

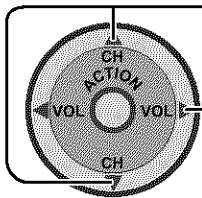

Press to enter submenu field.

2 In OTHER ADJ2 submenu field press to select COLOR MATRIX.

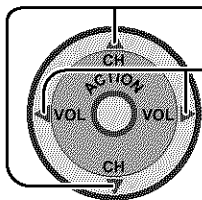

Press to select SD or HD.

SD : When the input signal is a normal TV system (NTSC).

HD : When the input signal is a High-Definition system (HD).

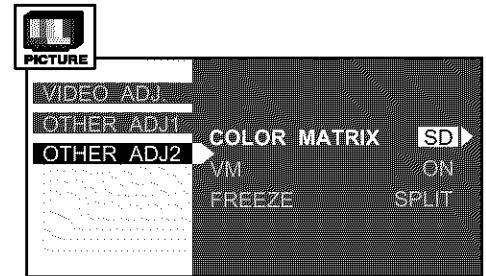

Note:

- (1) When viewing a non-standard DTV signal format, you can change color parameters manually for the best picture quality.
- (2) COLOR MATRIX does not need to be set when using High-Definition equipment or 480i output equipment. Use only for 480p signal source.

VM (Velocity Modulation)

Select ON to emphasize the edge of an image, or select OFF.

1 In PICTURE menu press to select OTHER ADJ2.

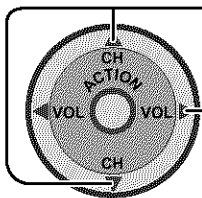

Press to enter submenu field.

2 In OTHER ADJ2 submenu field press to select VM.

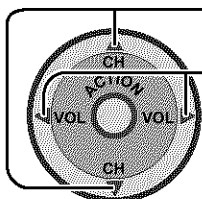

Press to select ON or OFF.

ON ↔ OFF

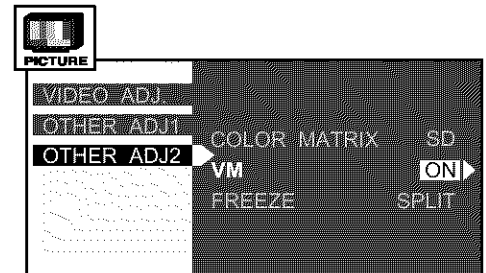

FREEZE

Select SPLIT or PIP to determine the frozen picture frame during single screen.

1 In PICTURE menu press to select OTHER ADJ2.

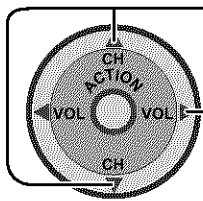

Press to enter submenu field.



2 In OTHER ADJ2 submenu field press to select FREEZE.

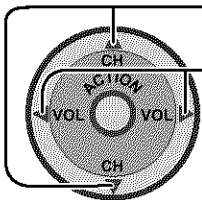

Press to select SPLIT or PIP.

SPLIT ↔ PIP

3 When the screen is single press  to freeze the screen.



When FREEZE SPLIT is selected.



When FREEZE PIP is selected.

4 Press  again to recover.

Notes:

(1) When  is pressed during Split Screen, the Split Screen will be frozen and the main picture continues action (see page 44).



(2) When  is pressed during PIP Operation, the PIP frame will be frozen and the main picture continues action (see page 43).

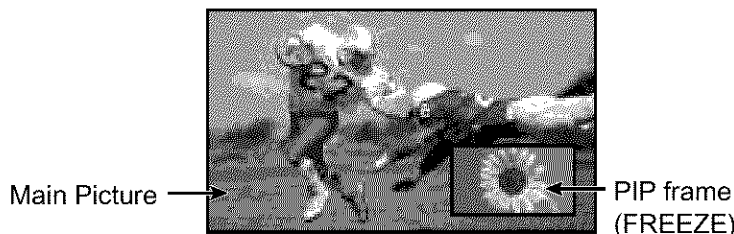

CHANNEL SCAN

CHANNEL SCAN Let you select the channel scanning mode either FAV or ALL.

CHANNEL SCAN FAV To enter up to 16 favorite channels.

CHANNEL SCAN ALL To scan all channels when using the CH up/down buttons.

1

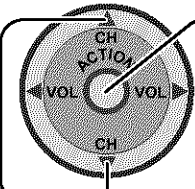

Press to display the roller guide menu.

Press to rotate to CHANNELS.

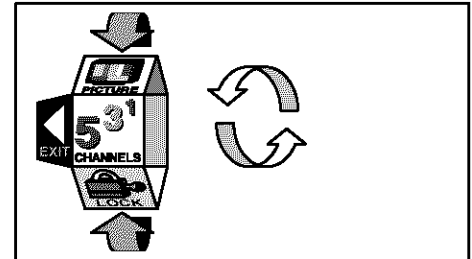

2

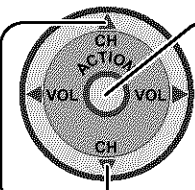

Press to display CHANNELS.

Press to select FAVORITES.

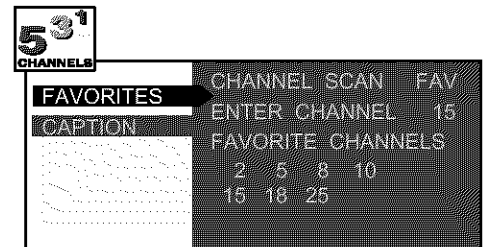

3

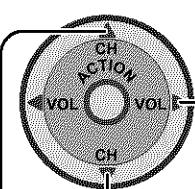

Press to enter submenu field.

Press to select CHANNEL SCAN.

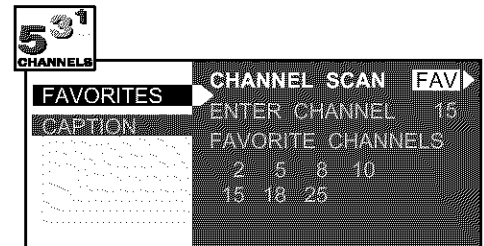

4

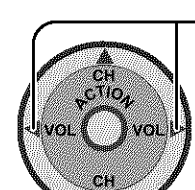

Press to select FAV or ALL.

FAV ↔ ALL

FAVORITE CHANNELS Selection

- 1 Under CHANNEL SCAN FAV press to select ENTER CHANNEL.

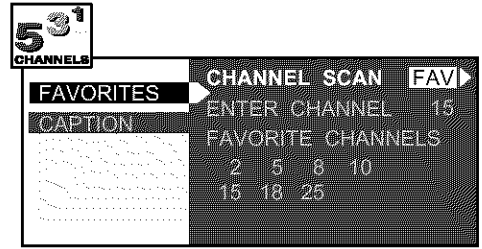
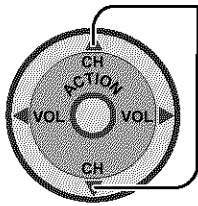

- 2 Use remote numeric keypad to select desired channel.

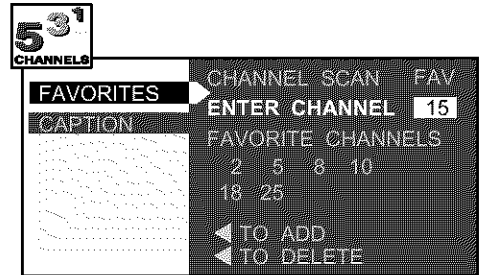
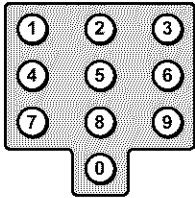

(Example: Channel 15 is selected)

- 3 Press **▶** to add or **◀** to delete the selected channel.

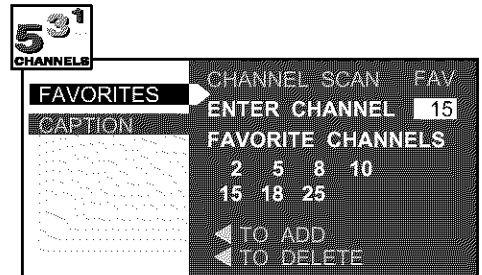
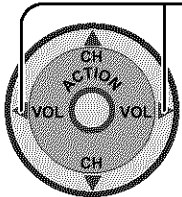

(Example: Channel 15 is added)

- 4 Repeat step 2 to 3 up to 16 favorite channels.

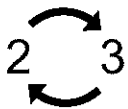

To end Adjustment:

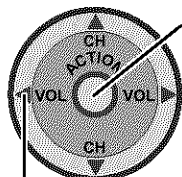

Press twice to return to the roller guide.

Press to exit roller guide.
This returns the set to normal viewing.

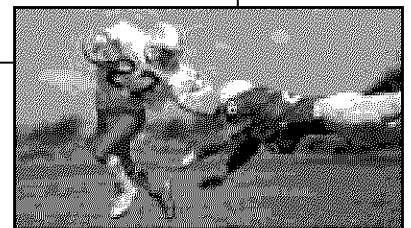
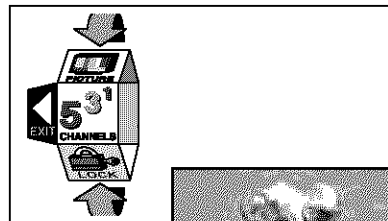

NORMAL PICTURE

CAPTION

1 Press to display the roller guide menu.

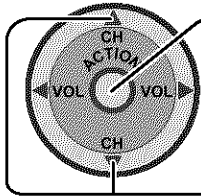

Press to rotate to CHANNELS.

2 Press to display CHANNELS.

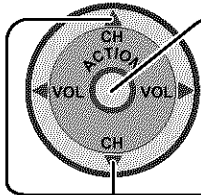

Press to select CAPTION.

3 Press to enter submenu field.

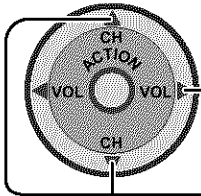

Press to select PRESET CAPTION / MANUAL CAPTION / INPUT LABEL.



Proceed to each adjustment menu.

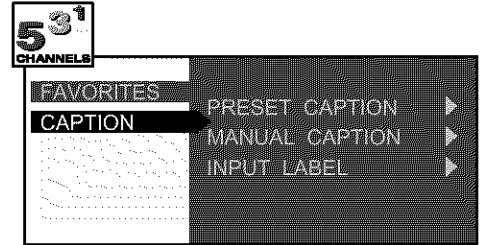
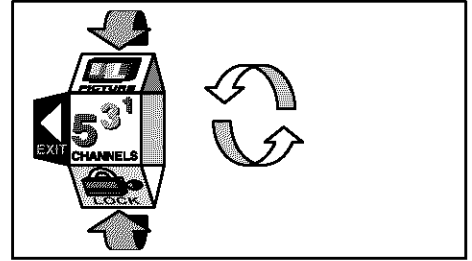

4 To end Adjustment:

Press twice to return to the roller guide.

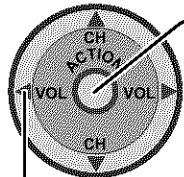

Press to exit roller guide.
This returns the set to normal viewing.

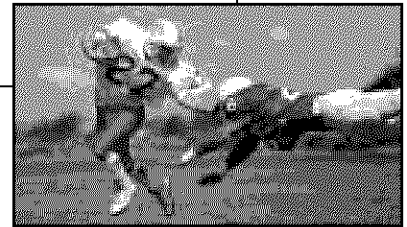
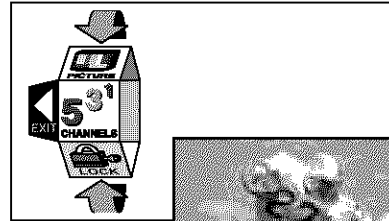

NORMAL PICTURE

PRESET CAPTION Assign channel numbers to pre-set popular TV stations.

1 Under PRESET CAPTION press to display next menu.

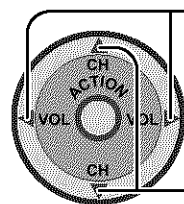

Press to select desired preset caption.

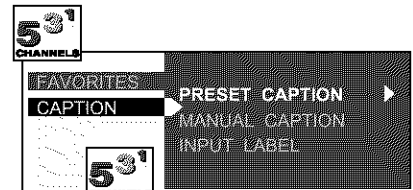

2 Use remote numeric keypad to select desired channel (refer to your local TV guide).

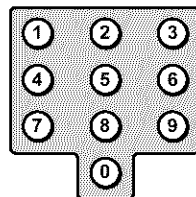

Note:
To delete a channel, press ◀ VOL while channels highlighted.

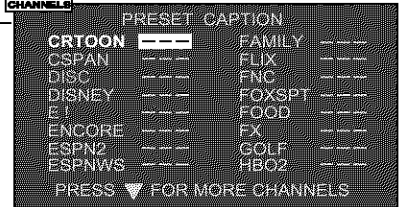

MANUAL CAPTION Enter channel numbers and captions manually.

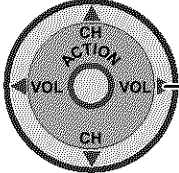
1  Under MANUAL CAPTION press to display next menu.

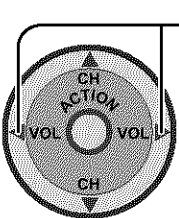
2  Press to enter desired channel.

OR

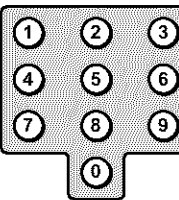
 Use remote numeric keypad to select desired channel (refer to your local TV guide).

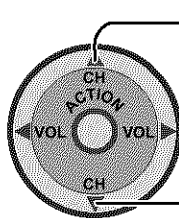
3  Press to select ENTER CAPTION.

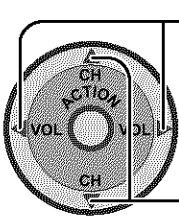
4  Press to select characters.

 Press to move cursor.
Repeat Step 4 up to 4 characters.

Note:

In MANUAL CAPTION up to 4 characters can be selected as a CAPTION.

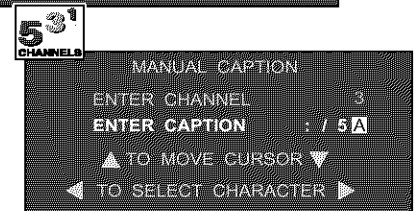
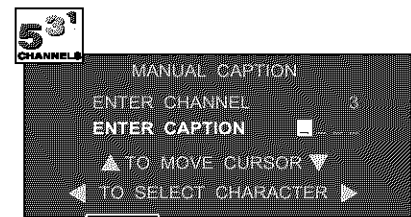
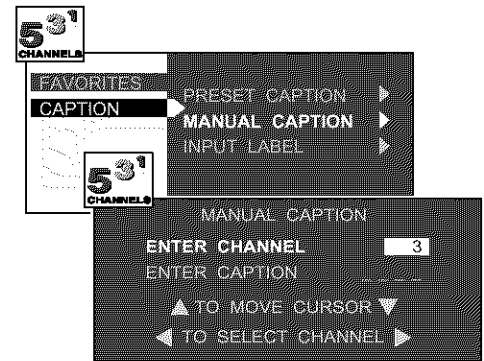

INPUT LABEL Label video input connections to display optional equipment.

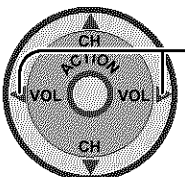
1  Under INPUT LABEL press to display next menu.

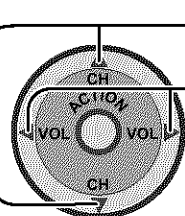
2  Press to move cursor.

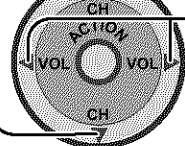
 Press to select desired LABEL.

Note:

To delete, select LABEL, then press ◀ VOL or VOL ▶ to select "SKIP". The selected INPUT mode will be skipped when TV/VIDEO button is pressed.

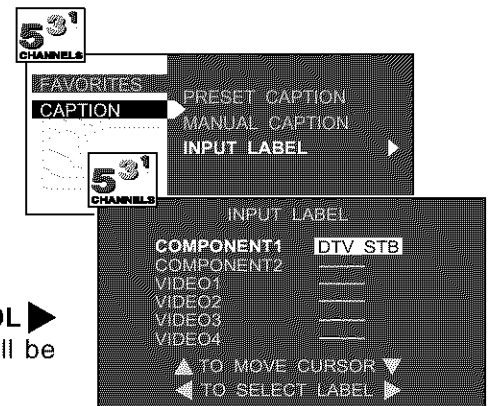

Selecting STEREO/SAP/MONO

1

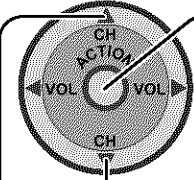

Press to display the roller guide menu.

Press to rotate to AUDIO.

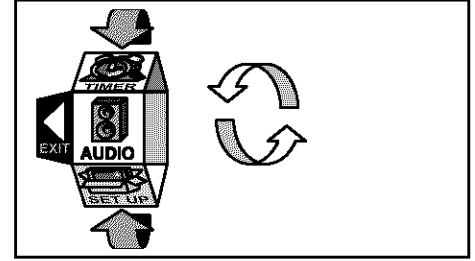

2

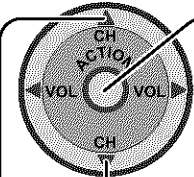

Press to display AUDIO.

Press to select AUDIO ADJ..

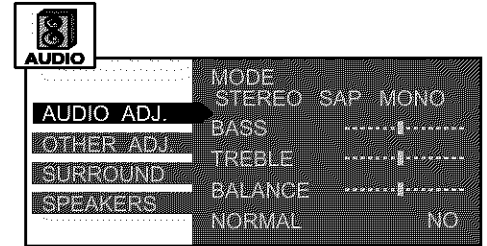

3

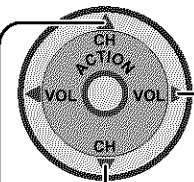

Press to enter submenu field.

Press to select MODE.

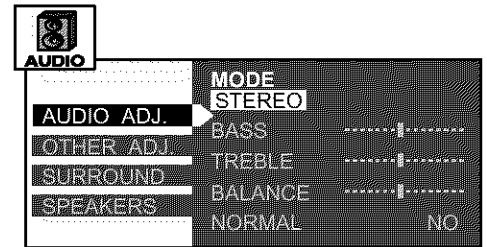

4

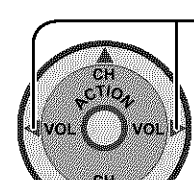

Press to select STEREO / SAP / MONO.

Red display - Signal available
White display - Signal not available

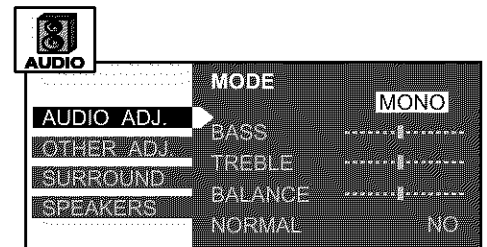

5 To end Adjustment:

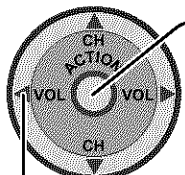

Press twice to return to roller guide.

Press to exit roller guide.
This returns the set to normal viewing.

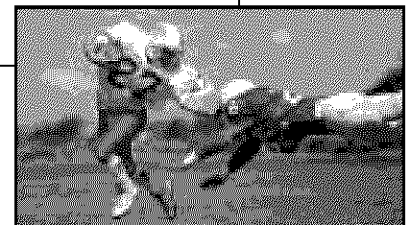
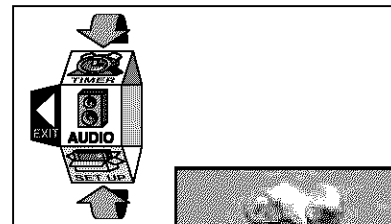

NORMAL PICTURE

Note:
AUDIO MODE selection is also possible by pressing the  button on the remote control (see page 17).

Helpful Hints:

- **STEREO** - Two channel Audio reception.
- **SAP** - Second Audio Programming (typically used for bilingual audio).
- **MONO** - Use when stereo signal is weak.

Audio Adjustment

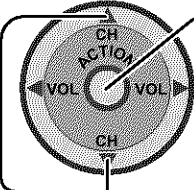
1  Press to display the roller guide menu.

 Press to rotate to AUDIO.

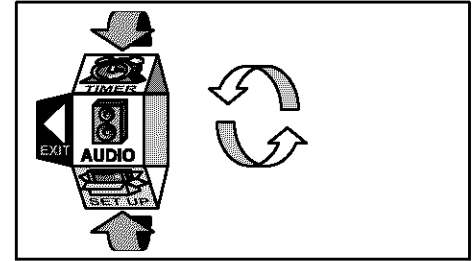

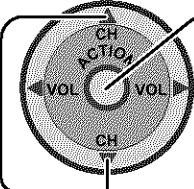
2  Press to display AUDIO menu.

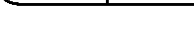
 Press to select the main menu.

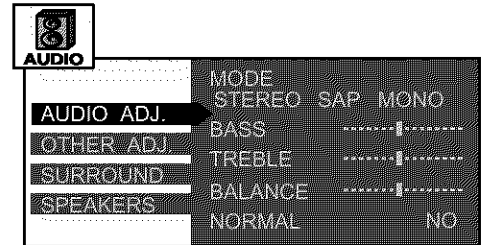
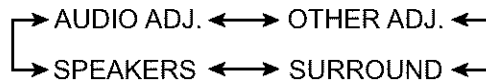

Proceed to each adjustment item of the selected main menu.

Selecting BASS / TREBLE / BALANCE / NORMAL

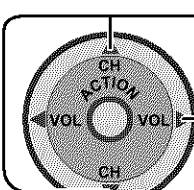
1  In AUDIO menu press to select AUDIO ADJ..

 Press to enter submenu field.

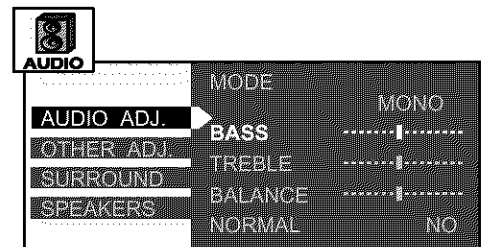

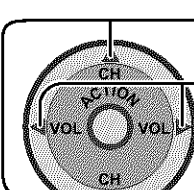
2  Press to select BASS / TREBLE / BALANCE / NORMAL.

 Press to adjust the desired level by listening to the sound.

Item	Effect	Function
BASS	◀ Less ▶ More	Increase or decrease the bass response.
TREBLE	◀ Less ▶ More	Increase or decrease the treble response.
BALANCE	◀ Left SP. ▶ Right SP.	Emphasize the left / right speaker volume.
NORMAL	▶ NO	Reset BASS, TREBLE and BALANCE adjustments to factory default settings.

Audio Adjustment

AI SOUND / BBE

AI SOUND Equalize overall volume levels across all channels.(AI sound is not available in VIDEO mode).
BBE Use special signal processing to accurately reproduce the "attack" of each sound, in order to make it immediate and superbly faithful to the original, while retaining its natural feel.

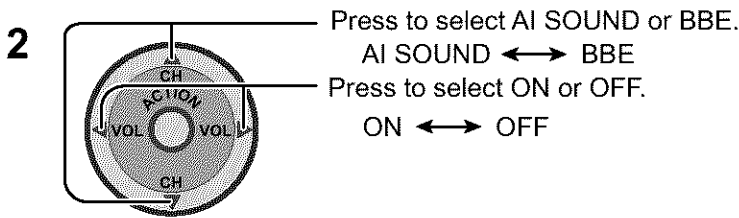
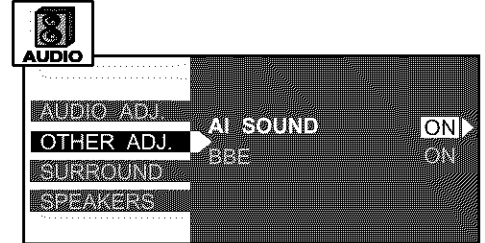
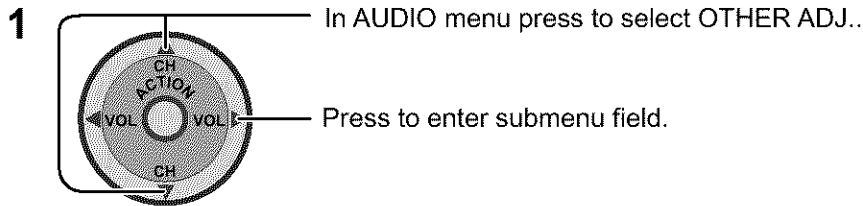

Note:
All SOUND is not available in VIDEO mode.

SURROUND

To enjoy a concert hall effect, turn the SURROUND to ON.

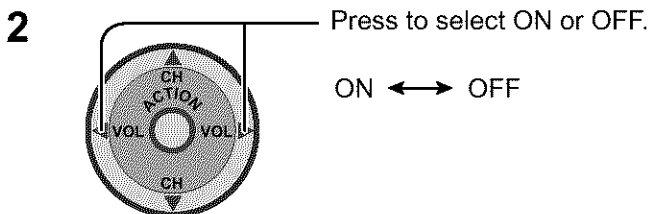
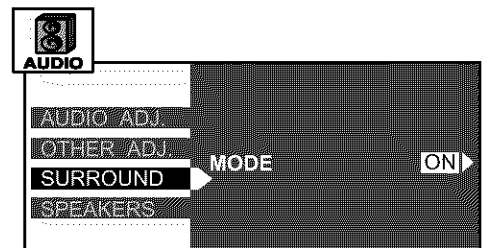
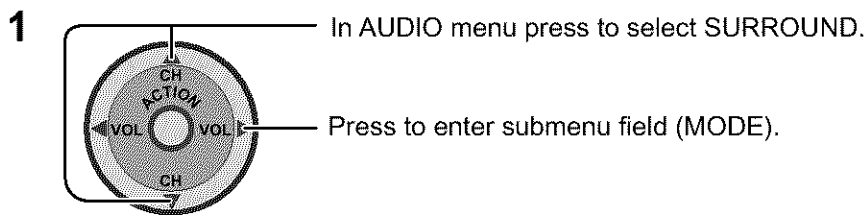

Notes:
During stereo sound or soft playing : SURROUND → set to ON.
During normal sound : SURROUND → set to OFF.

SPEAKERS

In AUDIO menu under SPEAKERS, select the desired SPEAKER mode.

1 In AUDIO menu press to select SPEAKERS.

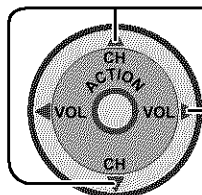

Press to enter submenu field.

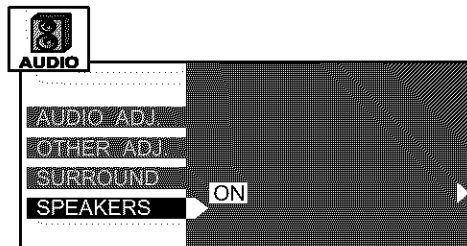

2 Press to select your desired mode.

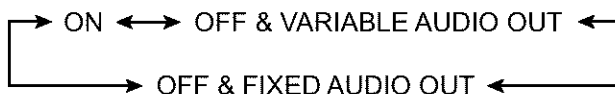
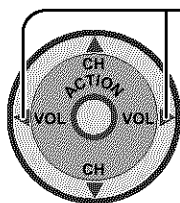

Mode	Function
ON	TV speakers operate normally.
OFF & Variable Audio Out	TV speakers off -audio adjustable by television.
OFF & Fixed Audio Out	TV speakers off -audio adjustable by the external amplifier only.

To end Adjustment:

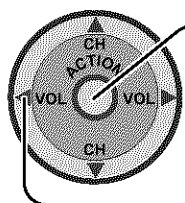

Press twice to return to the roller guide.

Press to exit roller guide.
This returns the set to normal viewing.

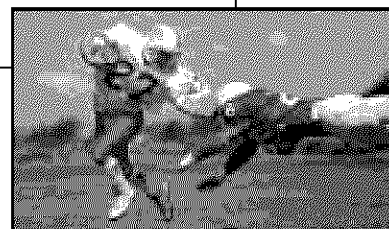
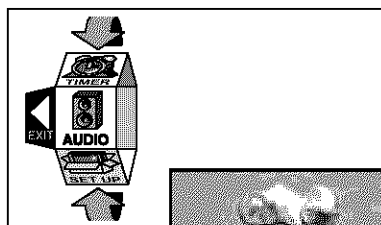



NORMAL PICTURE

Picture in Picture Operation

This television includes a two-tuner Picture In Picture (PIP) feature. This allows you to watch two (2) live broadcasts at the same time with or without an external video source such as a VCR, cable box, etc.

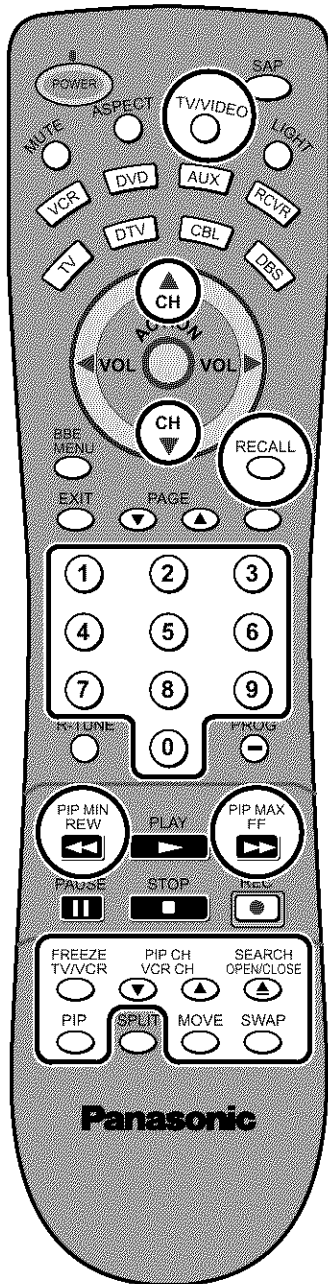

Basic PIP Operation

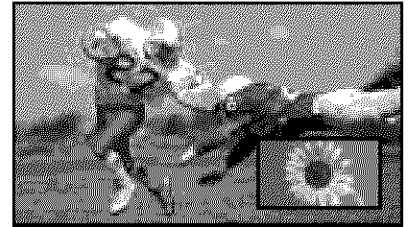

- 1  Press the PIP button on the remote control to display the PIP Frame on screen.

Note:
Audio is from Main Picture only.

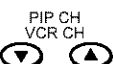

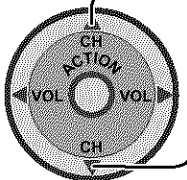

- 2  Select channels for the PIP frame by pressing .

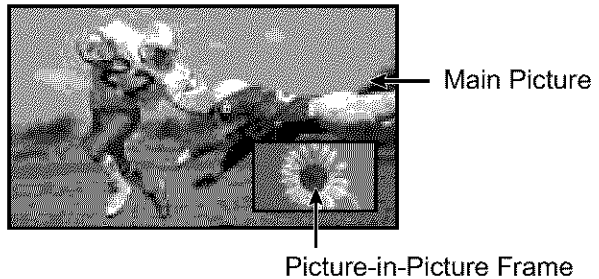
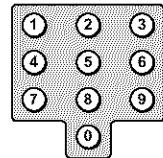
- 3  Press to select channel for the Main Picture.
or
Use the remote control numeric keypad.



- 4  Press to view picture source status.

- 5  Press  again to cancel the PIP Frame.

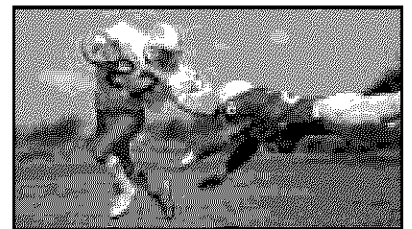

- SWAP** 

Press  to switch the PIP and MAIN PICTURE source.

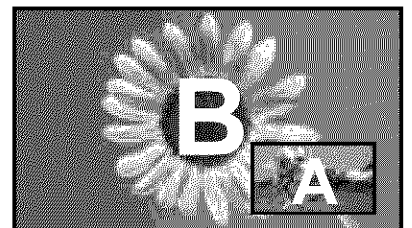
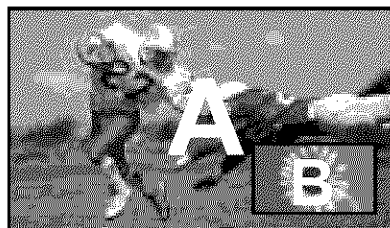

PIP MIN, PIP MAX



These features are used to size PIP Frame.

Press or to size the PIP Frame.

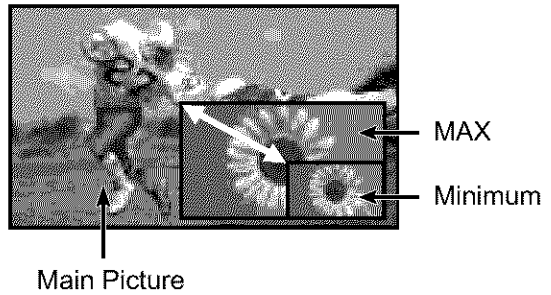

Freeze



During PIP operation this feature is used to stop action in PIP frame.

1 Press to stop PIP frame action.

2 Press again to continue action.

Note:

To stop action for Main picture:

1 In PICTURE MENU OTHER ADJ2, select FREEZE PIP or SPLIT (see p33).

2 Press while PIP frame is not displayed.

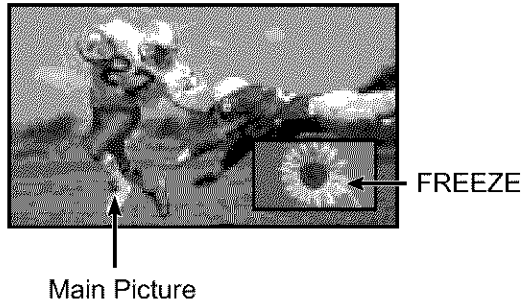

TV/VIDEO Button



Press when PIP frame is displayed to select desired input mode.

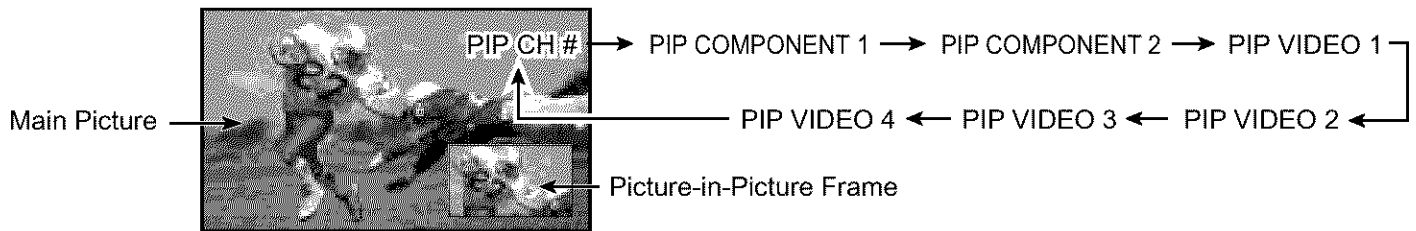

Search



This feature lets you scan through all available channels.

1 Press to display search frames.

2 Press again to stop search feature. This returns the screen to the previous condition (single screen, PIP screen or SPLIT screen).

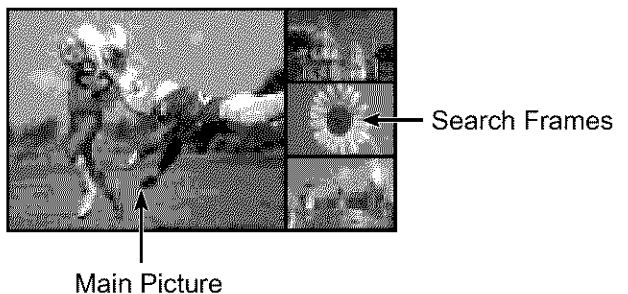

Move



This feature is used to move PIP frame to one of four corners.

Press to position PIP frame to desired corner.

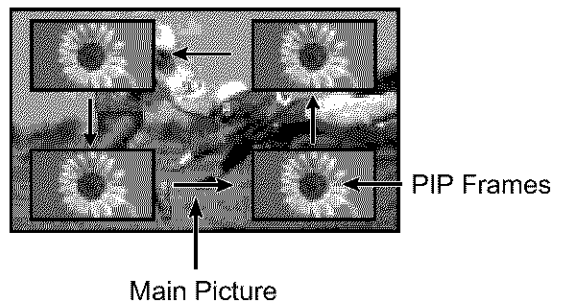

Split Screen

This feature lets you watch two different channels side by side with or without an external video source. The audio is from the Main picture only (left side). Split screen enables you to search other channels on the right screen or check video recording status.

Splitting the screen

- 1 Press  to display Split screen.





(The previously selected screen appears.)

- 2 Returning to one screen.
Press  again to return.



Freezing pictures

During Split Screen this feature is used to stop action in SPLIT screen.

- 1  Press  to stop action in SPLIT screen.

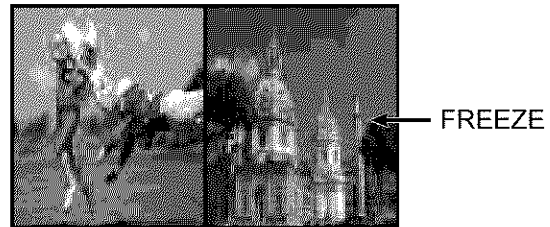

- 2 Press  again to recover.

Note:

To stop action for Main picture:

- 1 In PICTURE MENU OTHER ADJ2, select FREEZE PIP or SPLIT (see p33).
- 2 Press  while SPLIT frame is not displayed.

Notes:

- (1) Sound from the left screen is output from the speakers on the TV set (and earphone jacks).
- (2) When the screen is split, signals of the left screen are output from the rear monitor output terminal.
- (3) The left and right screen are processed by individual circuits, and therefore, may have slight variation in sound and image quality.
- (4) Split screen returns to single screen when the TV is turned off.
- (5) The right and left screens cannot display the same picture at the same time.
- (6) Use the right screen when playing video games on a split screen (to avoid distortion of images).

Changing the channels for the Split Screen



Select channels for the Split Screen by pressing .

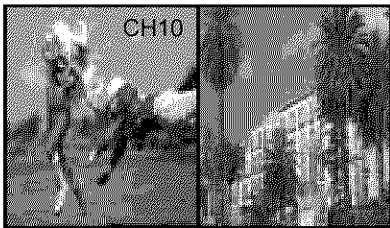
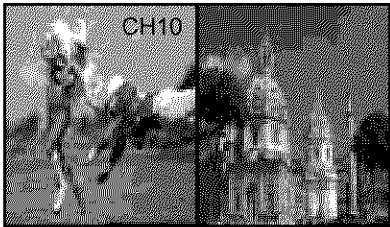

Changing the channels for the Main Picture

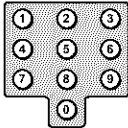

Select channels for the Main Picture by pressing or use the remote control numeric keypad.

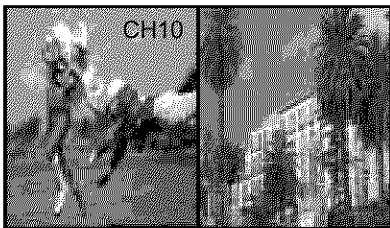

Swapping left and right screens



Press to switch the SPLIT SCREEN and MAIN PICTURE source.

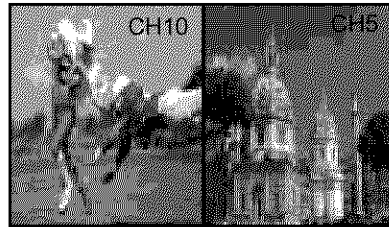

Viewing Videos



While Split screen is displayed, press to switch modes.

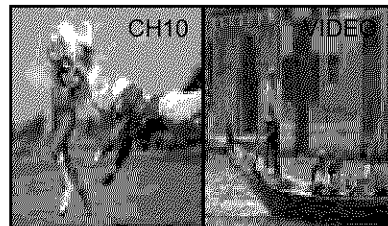

Searching the other channels



press to search the other channels.

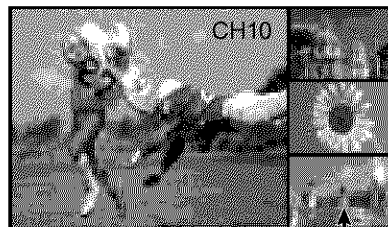

Search Frames

Press again to stop the search.

This returns the screen to its previous condition.

ASPECT Controls

The color monitor will allow you to enjoy viewing the picture at its maximum size, including wide screen cinema format picture.

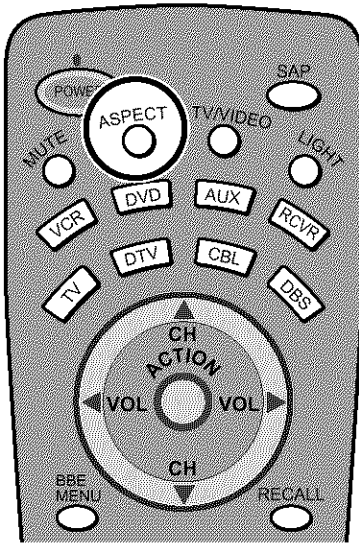

ASPECT button

The aspect mode changes each time the ASPECT button is pressed.

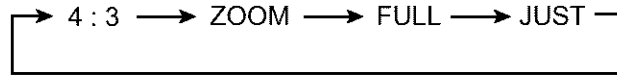

Notes:

(1) For a 480p signal input during component input signal mode, the mode will change as follows:

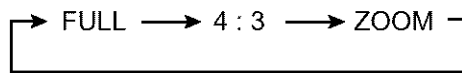

(2) When a 1080i signal is being received, the mode is set to FULL, and aspect switching is not possible.

(3) During PIP operation, ASPECT Controls are available only in the main picture according to the receiving signal of the main picture.

(4) During SPLIT Screen, ASPECT Controls are not available.

Mode	Picture	Explanation
4:3		4:3 will display a 4:3 picture at its standard 4:3 size.
ZOOM		ZOOM mode magnifies the central section of the picture.
FULL		FULL will display the picture at its maximum size but with slight elongation.
JUST		JUST mode will display a 4:3 picture at its maximum size but with aspect correction applied to the sides of the screen so that elongation is only apparent at the left and right edges of the screen. The size of the picture will depend on the original signal.

Notes:

(1) The S-VIDEO terminal on this set can detect specially encoded signals that are compatible with a wide screen monitor. When a full image from the S-VIDEO terminal of specially encoded video is detected by the set, the screen size is automatically set to FULL mode.

(2) The screen size also changes if ID-1 is detected.

(3) The screen size will also change if S1 detection has been set.

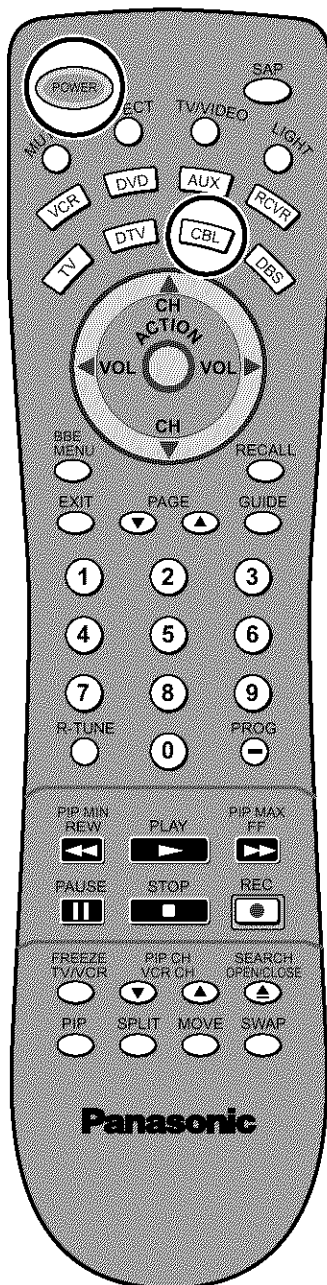
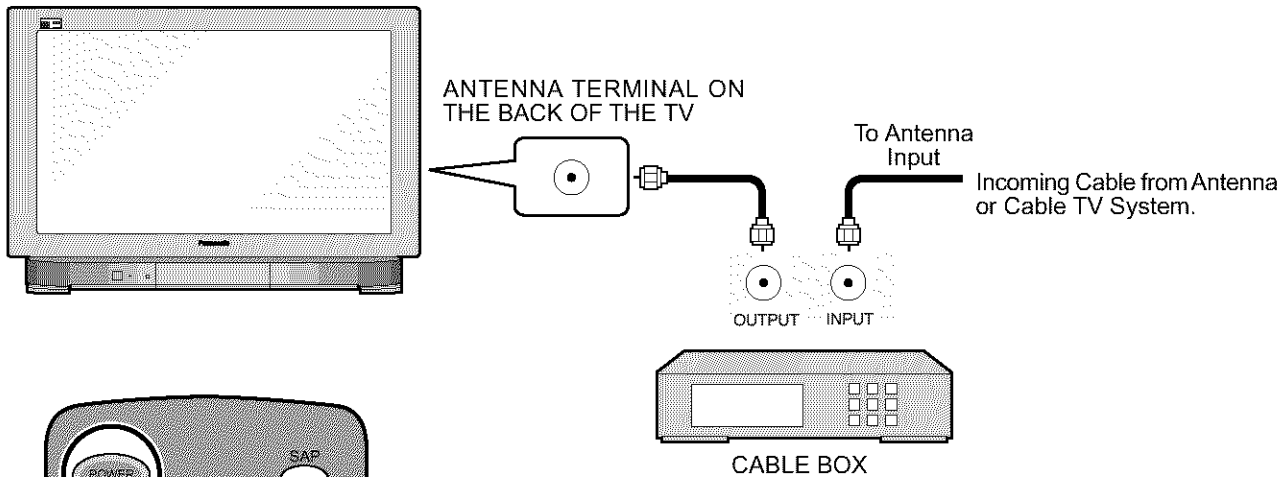

Cable TV

When the antenna cable is connected to the TV antenna terminal via a cable box or VCR, set the TV channel to CH3 or CH4. This does not apply when signal is input from VIDEO INPUT.



Confirming

Confirm that registration with cable TV provider and connection of equipment are completed. Turn the CABLE BOX on and select the desired volume level.

1  Press  to confirm.

2  Press while pointing the remote control towards the CABLE BOX.

Note:

The remote control code number is set for Panasonic products.

When peripheral equipment does not operate, reset code (See page 62 - 63).

3 Operate the CABLE BOX and select the desired volume level.

TIMER

The TIMER can switch the TV ON or OFF. Before attempting TIMER1 and TIMER2 confirm the CLOCK SET and adjust if necessary. Then set TIMER1 and TIMER2.

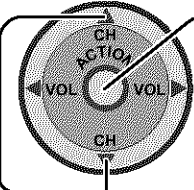
- 1  Press to display the roller guide menu.
Press to rotate to TIMER.

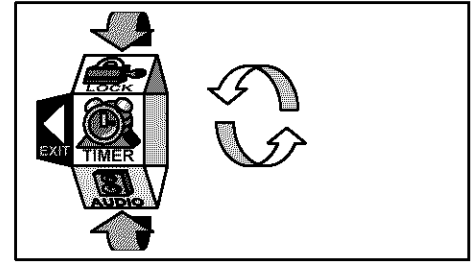

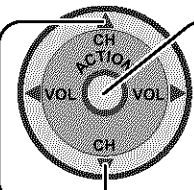
- 2  Press to display TIMER.
Press to select the main menu.

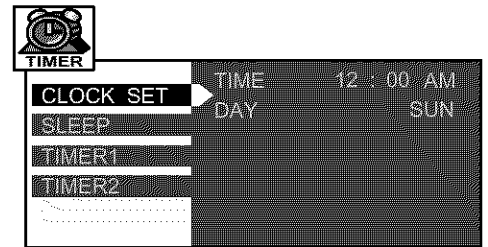

Proceed to each adjustment item of the selected main menu.

3 To end Adjustment:

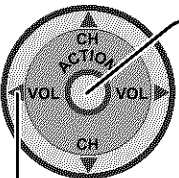
-  Press twice to return to the roller guide.
Press to exit roller guide.
This returns the set to normal viewing.

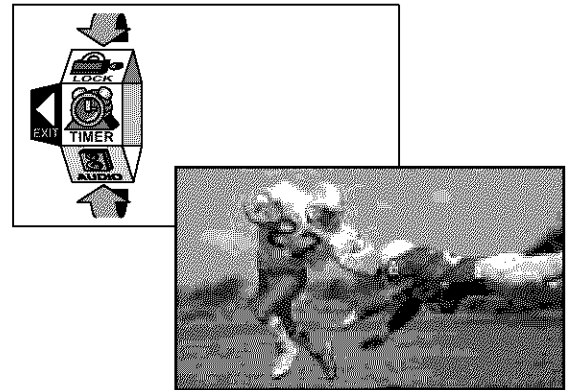

NORMAL PICTURE

CLOCK SET

CLOCK SET sets the present time. This is necessary to operate the TIMER features.

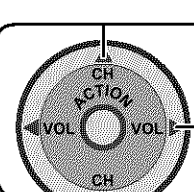
- 1  In TIMER menu press to select CLOCK SET.
Press to enter submenu field.

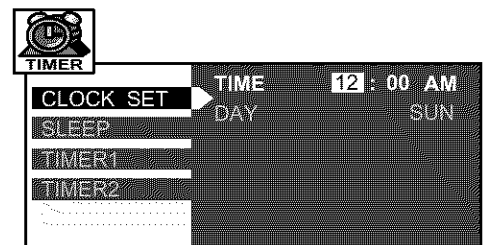

2 TIME Set the time of day.

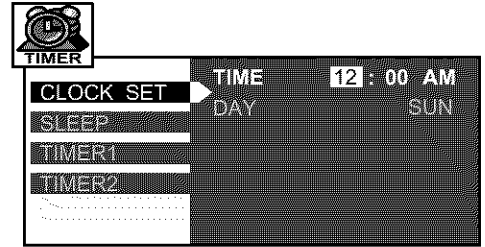
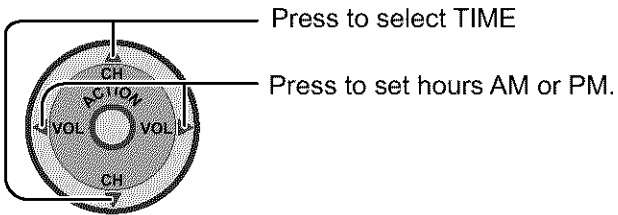

3 Press to move to minutes position.

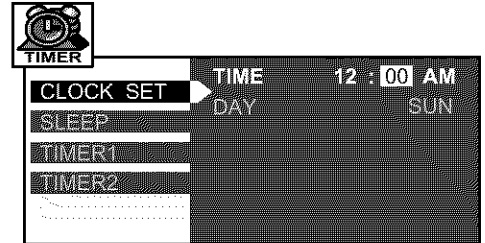
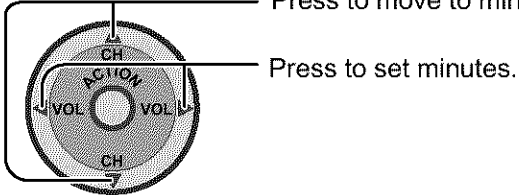

4 DAY Set the day of the week.

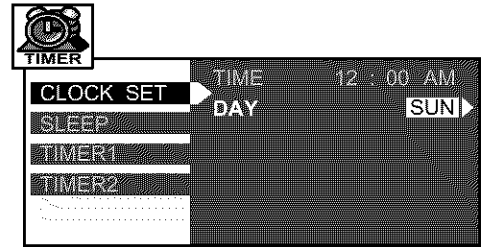
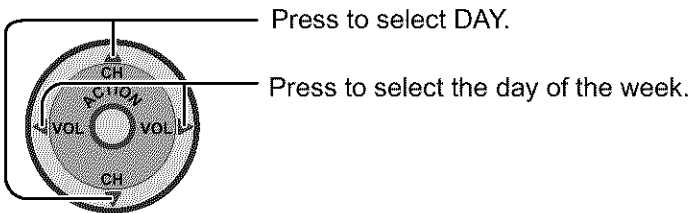

SLEEP

SLEEP sets the sleep time.

1 In TIMER menu press to select SLEEP.

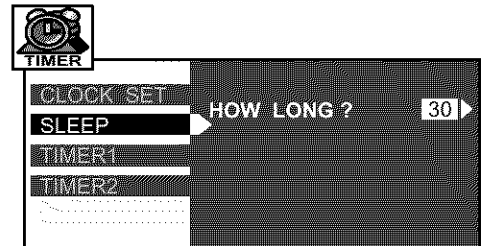
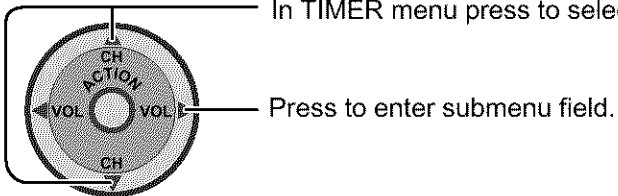

2 Press to select the desired sleep time. To turn off the timer select NO.

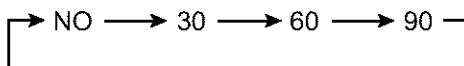
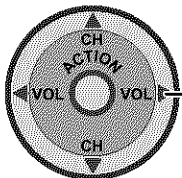

Timer1 and Timer2

In TIMER menu, select one or both timers to turn the television on and off at selected times, on selected channels, and on selected days. TIME must be entered in CLOCK SET to operate the TIMER features.

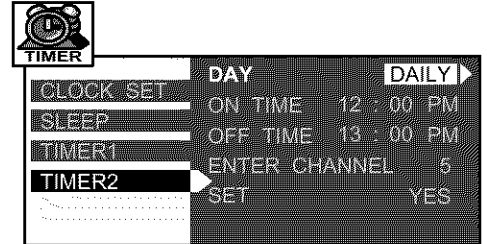
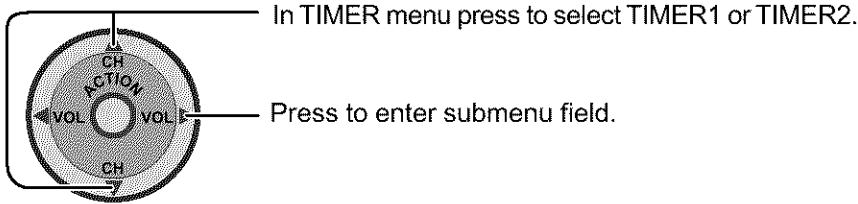

DAY Set the day of the week.

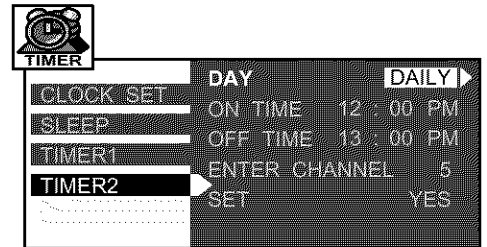
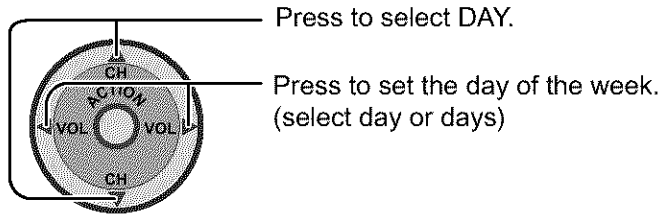

ON TIME Set the time of day.

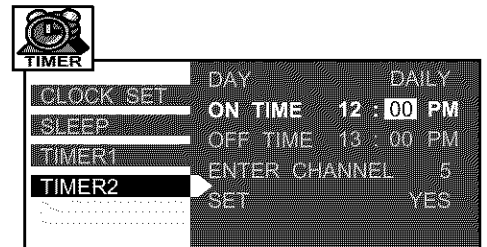
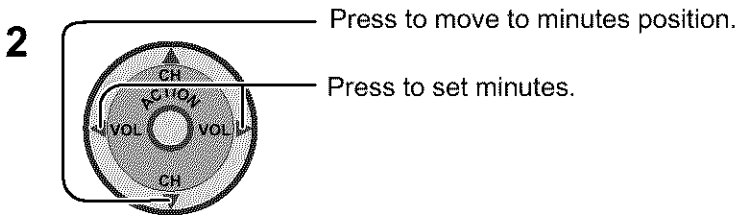
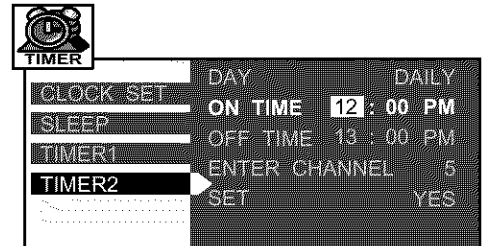
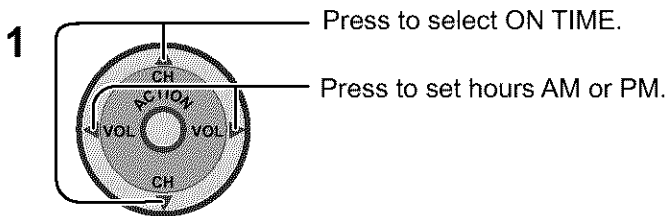

OFF TIME Set the time of day.

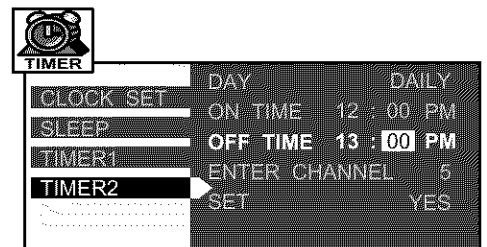
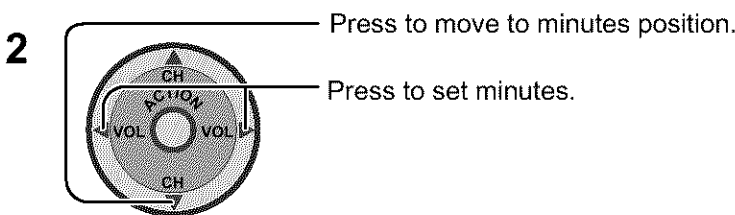
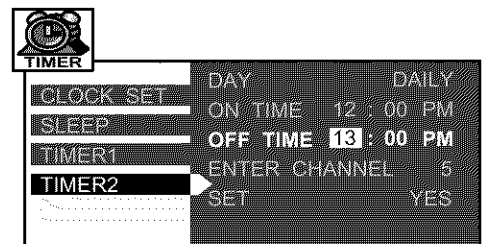
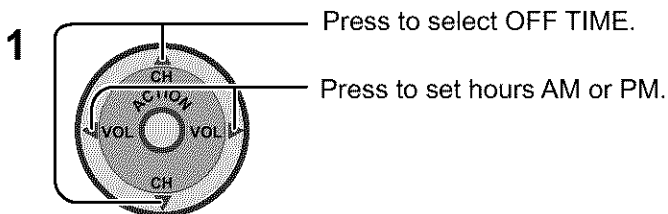

ENTER CHANNEL

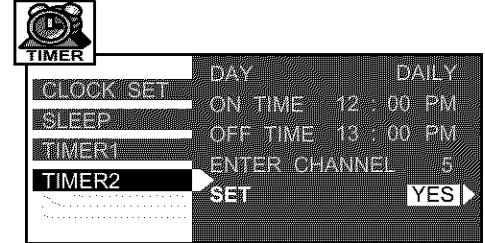
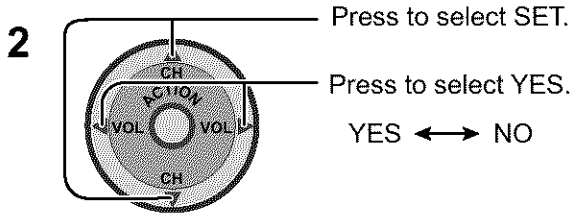
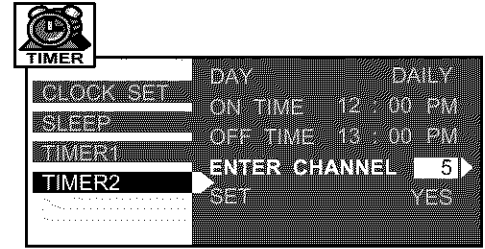
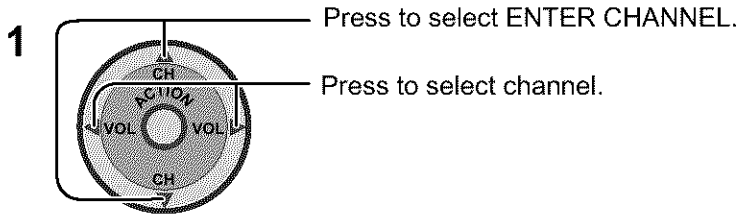

TIMER Activation

The TIMER is active when the television is OFF or ON. The television will switch to the selected channel at the selected time set in the TIMER.

Turn Off After 90 Minutes

The television automatically turns OFF after 90 minutes when turned ON by the TIMER. If the OFF time is selected or if a key is pressed, the automatic OFF after 90 minutes will be cancelled.

Notes:

- (1) When the power to the TV set is disrupted due to a power outage or similar problem, after power is restored, the off-timer will be deactivated and the TV will be in standby mode.
- (2) To see the remaining sleep time, press the RECALL button.

LOCK Feature

Select LOCK SET to prevent video games and VCR tapes from being viewed.

1

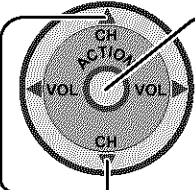

Press to display the roller guide menu.

Press to rotate to LOCK.

2

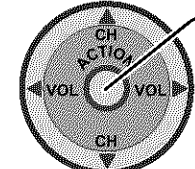

Press to display LOCK menu.

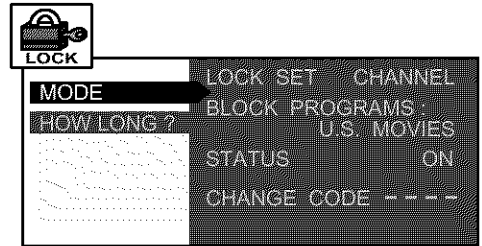
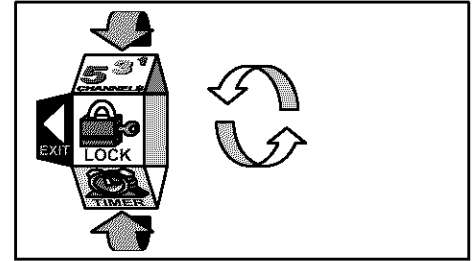

MODE To use LOCK options ENTER CODE FIRST.

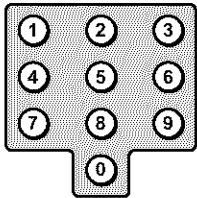

Use the remote numeric keypad to enter a four-digit secret code.

After entering your secret code for the first time, the onscreen display will change to CHANGE CODE.

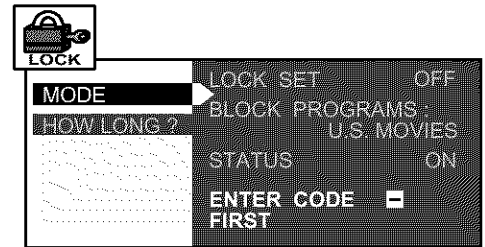

Notes:

- (1) Use a code that is easy to remember and record it in a safe place.
- (2) If you do not remember your code, LOCK will unlock in 12, 24, or 48 hours, depending on the current setup. Be cautious when selecting ALWAYS. If ALWAYS is selected, and you forget your secret code, the TV must be serviced by a qualified technician to clear the LOCK setup.
- (3) If you select CHANGE CODE, and you change your code from the one used in the LOCK menu, your new code becomes the controlling code.

LOCK SET

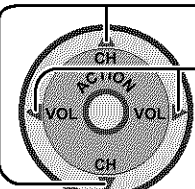

In MODE submenu press to select LOCK SET.

Press to select LOCK MODE.

OFF ↔ GAME ↔ CHANNEL ↔ ALL

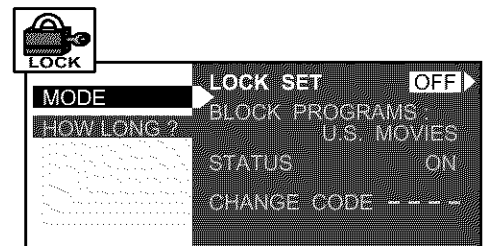

↓
Proceed to each adjustment menu.

MODE	Function
OFF	Turns Lock function off.
GAME	Lock CH 3, 4 and Video inputs.
CHANNEL	Lock up to four channels.
ALL	Locks all channels and video inputs.

To end Adjustment:

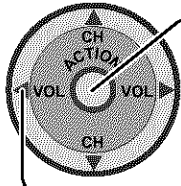

Press twice to return to the roller guide.



Press to exit roller guide.
This returns the set to normal viewing.

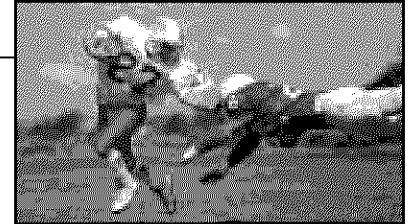
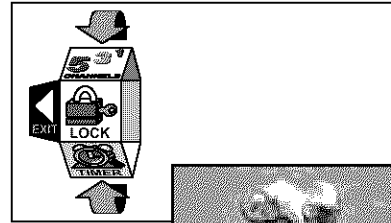

NORMAL PICTURE

OFF

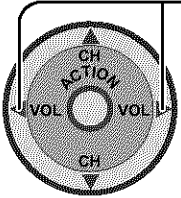

In LOCK MODE press to select OFF.

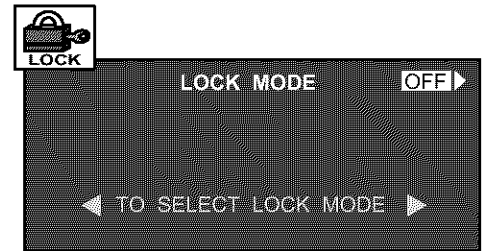

GAME

1

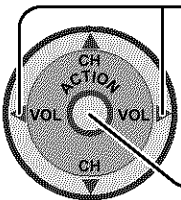

In LOCK MODE press to select GAME.

Press ACTION twice.

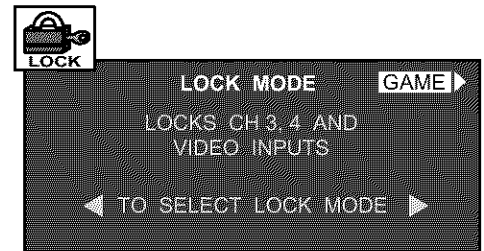

2

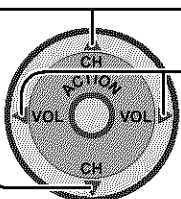

Press to highlight HOW LONG ?

Press to select 12HOURS, 24HOURS, 48HOURS or ALWAYS.

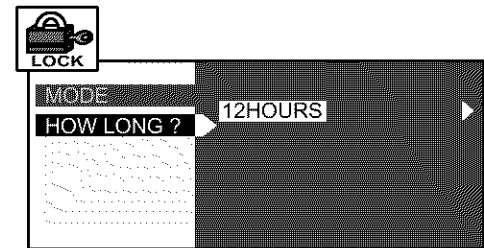
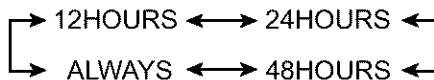

LOCK Feature

CHANNEL

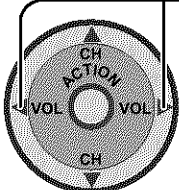
- 

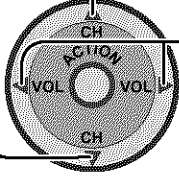
In LOCK MODE press to select CHANNEL.
- 

Press to select channel position.
Press to select channels.
(Or use remote numeric keypad to select channels.)

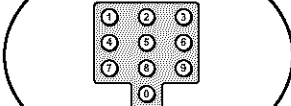

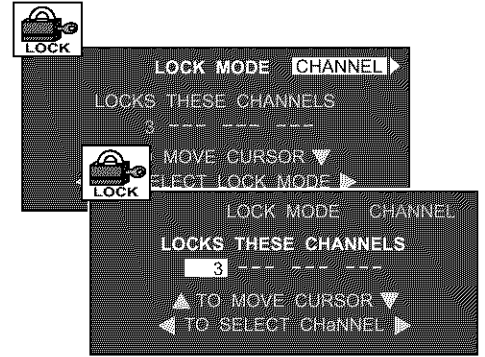

- Repeat step 2 for up to four channels.

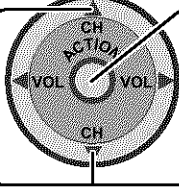
- 

Press ACTION twice.
Press to highlight HOW LONG ?

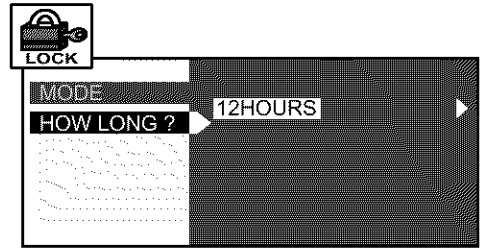

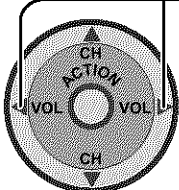
- 

Press to select 12HOURS, 24HOURS, 48HOURS or ALWAYS.

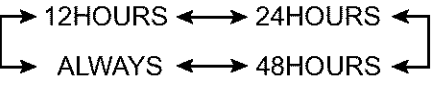

ALL

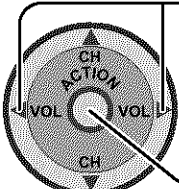
- 

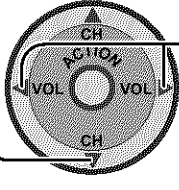
In LOCK MODE press to select ALL.
Press ACTION twice.
- 

Press to highlight HOW LONG ?
Press to select 12HOURS, 24HOURS, 48HOURS or ALWAYS.

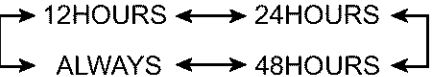

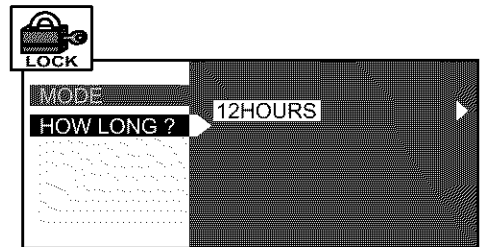
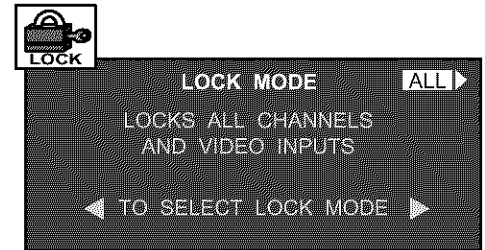

Note:

PG will display on screen if a blocked channel or video input is selected.

V-CHIP Menu OPERATION

In the United States and Canada, the V-CHIP consists of two rating systems, which are MPAA (MOTION PICTURE) and TV PARENTAL GUIDELINES. Its function is to block programs by following the rating data in the XDS data packets sent from broadcasting stations. The user can select which rating programs should be blocked by using the LOCK MENU options.

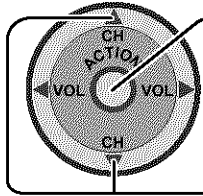
1  Press to display the roller guide menu.

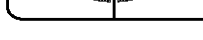
 Press to rotate to LOCK.

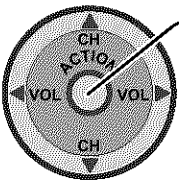
2  Press to display LOCK menu.

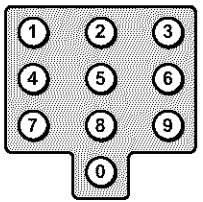
3  Use the numeric keypad to enter your number digit code.
(Use a code that is easy to remember and record it in a safe place.)

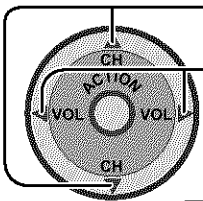
4  Press to enter the BLOCK PROGRAM field.
Press to select the desired menu.

The menu will change as follows:

U.S. TV PROGRAMS ↔ CANADIAN ENGLISH
U.S. MOVIES ↔ CANADIAN FRENCH

↓
Proceed to the selected menu.

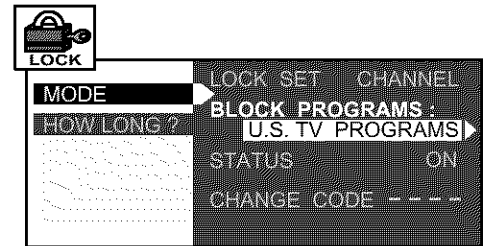
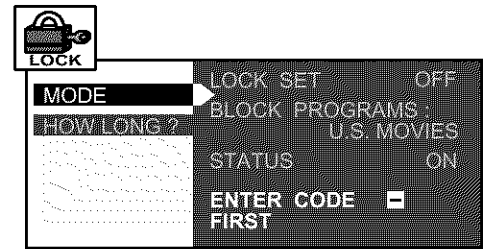
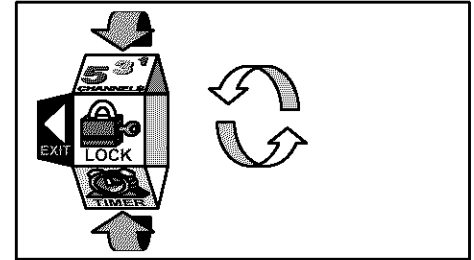

After finished with adjustments in the selected menu:

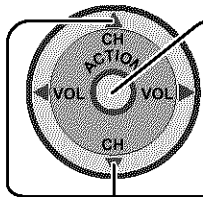
1  Press twice to return to MODE in LOCK menu.

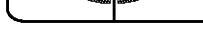
 Press to select HOW LONG?

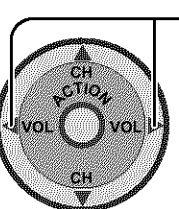
2  Press to select 12HOURS/24HOURS/48HOURS / ALWAYS.

12HOURS ↔ 24HOURS
ALWAYS ↔ 48HOURS

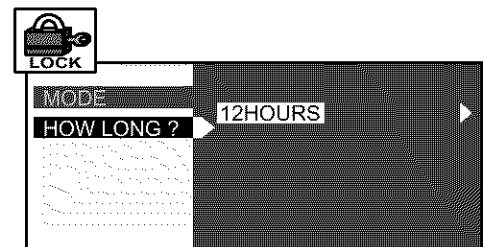
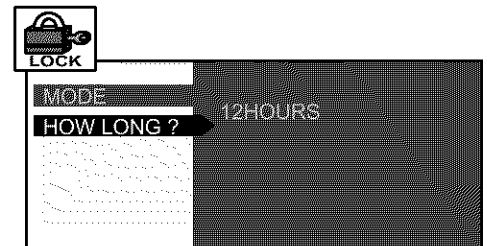

U.S. TV PROGRAMS

This TV model features the "V-Chip technology" which allows you to use U.S. TV PROGRAMS Guide ratings to block various types of TV programs. PIP will also be blocked automatically.

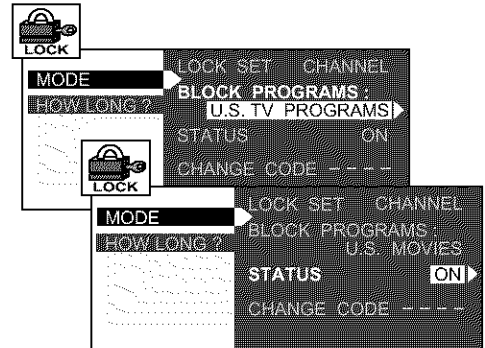
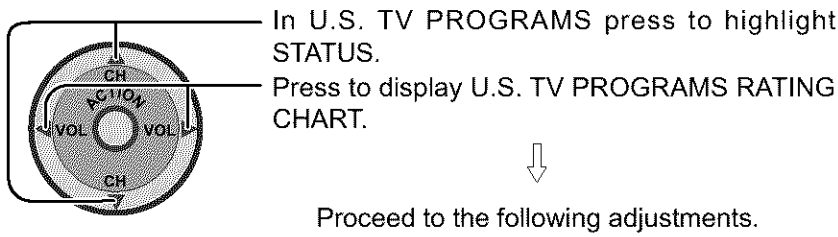

U.S. TV PROGRAMS RATING CHART

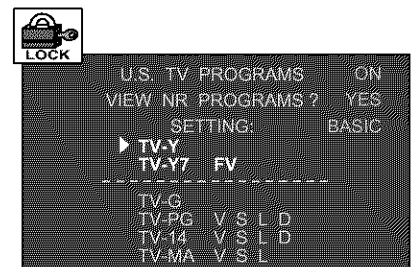
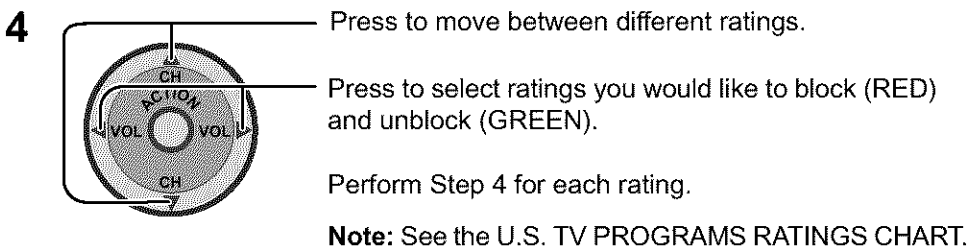
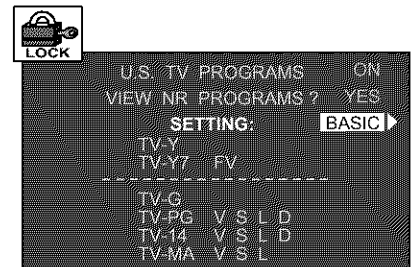
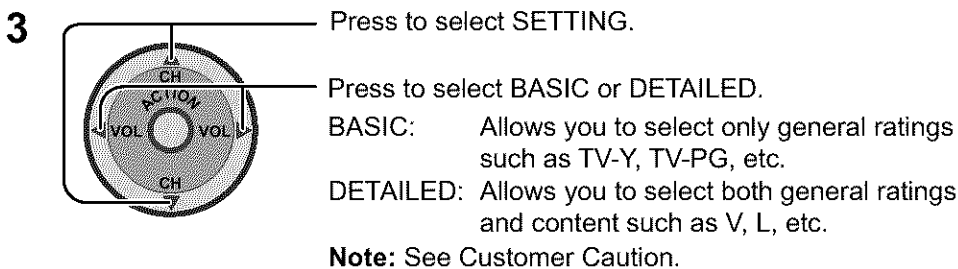
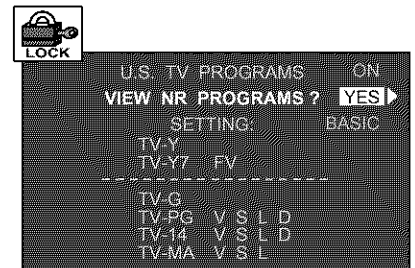
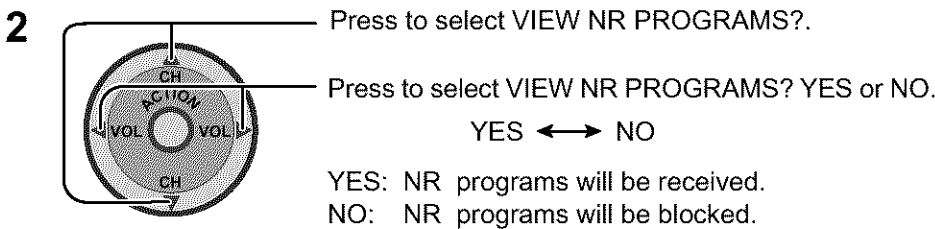
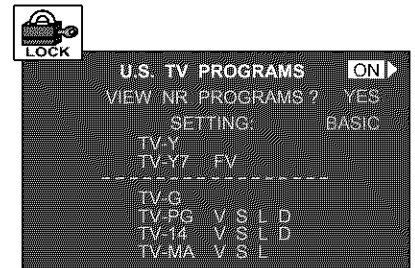
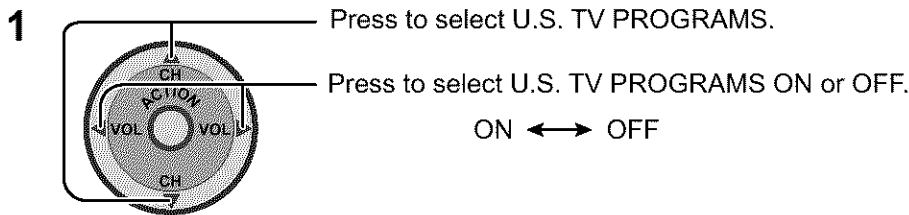

Customer Caution

The V-Chip system that is used in this set is capable of blocking "NR" programs (non rated, not applicable and none) per FCC Rules Section 15.120(e)(2). If the option of blocking "NR" programs is chosen "unexpected and possibly confusing results may occur, and you may not receive emergency bulletins or any of the following types of programming:"

- Emergency Bulletins (Such as EAS messages, weather warnings and others)
- Locally originated programming
- News
- Political
- Public Service Announcements
- Religious
- Sports
- Weather

U.S. TV PROGRAMS RATINGS CHART

NR	Not Rated. SEE CUSTOMER CAUTION above.
TV-Y	All children. The themes and elements in this program are specifically designed for a very young audience, including children from ages 2-6.
TV-Y7	Directed to older children. Themes and elements in this program may include mild physical or comedic violence, or may frighten children under the age of 7.
TV-G	General audience. It contains little or no violence, no strong language, and little or no sexual dialogue or situations.
TV-PG	Parental guidance suggested. The program may contain infrequent coarse language, limited violence, some suggestive sexual dialogue and situations.
TV-14	Parents strongly cautioned. This program may contain sophisticated themes, sexual content, strong language and more intense violence.
TV-MA	Mature audiences only. This program may contain mature themes, profane language, graphic violence, and explicit sexual content.
FV	FANTASY/CARTOON VIOLENCE
V	VIOLENCE
S	SEX
L	OFFENSIVE LANGUAGE
D	DIALOGUE WITH SEXUAL CONTENT



U.S. MOVIES

This TV model features the "V-Chip technology" which allows you to use Motion Picture Ratings when viewing movies or video tapes. This innovation allows parents to block various types of movies and video tapes at their discretion. PIP will also be blocked automatically.

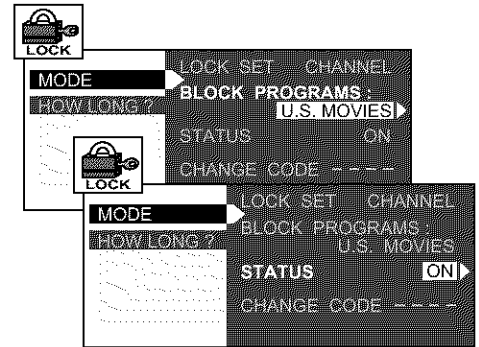
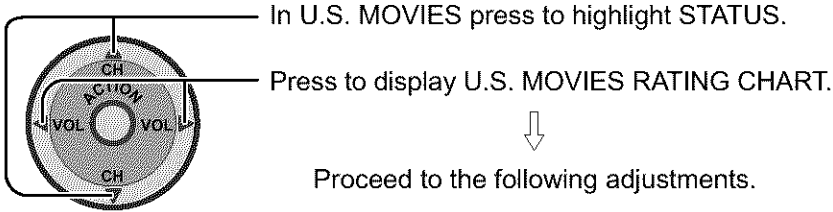

U.S. MOVIES RATING CHART

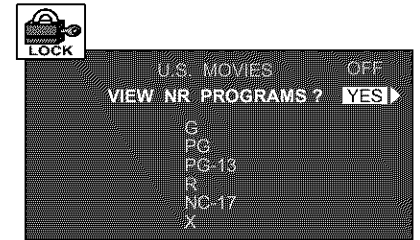
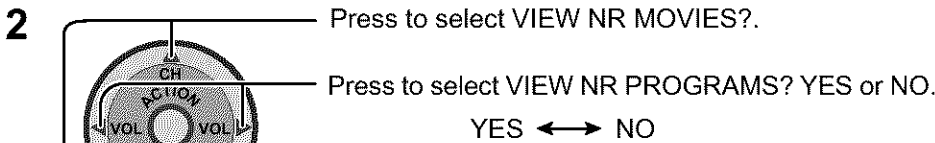
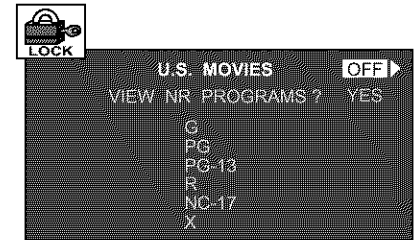
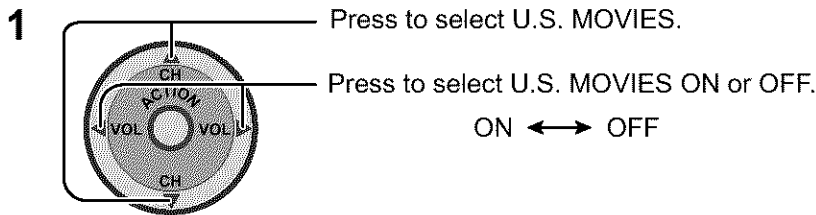

Note:
 Some movies are not rated for a variety of reasons. Old movies and foreign films are usually not rated.

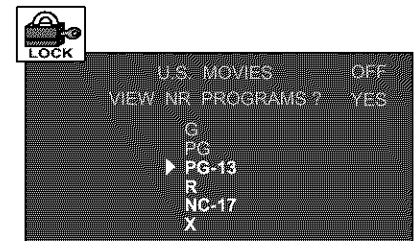
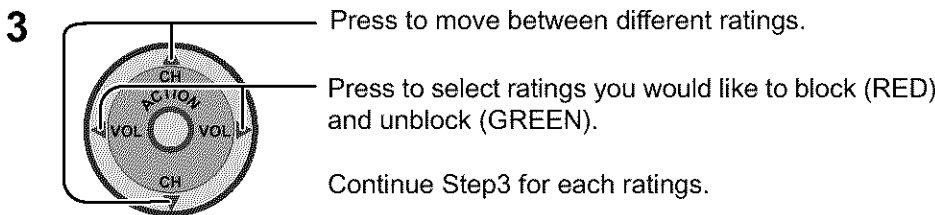

PG-13, R, NC-17 and X will be blocked.

Note: See the U.S. MOVIES RATINGS CHART.

U.S. MOVIES RATINGS CHART

NR	CONTAINS NO RATING (NOT RATED) AND NA (NOT APPLICABLE) PROGRAMS. Movie has not been rated or rating does not apply.
G	GENERAL AUDIENCES. All ages admitted.
PG	PARENTAL GUIDANCE SUGGESTED. Some material may not be suitable for children.
PG-13	PARENTS STRONGLY CAUTIONED. Some material may be inappropriate for children under 13.
R	RESTRICTED. Under 17 requires accompanying parent or adult guardian.
NC-17	NO ONE 17 AND UNDER ADMITTED.
X	ADULTS ONLY.

Canadian English

The V-CHIP used in this TV model allows you to block various types of movies and television programs based on the two rating systems used in Canada. PIP will also be blocked automatically.

1 In CANADIAN ENGLISH press to highlight STATUS.

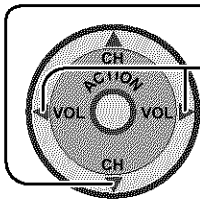

Press to display CANADIAN ENGLISH RATING CHART.

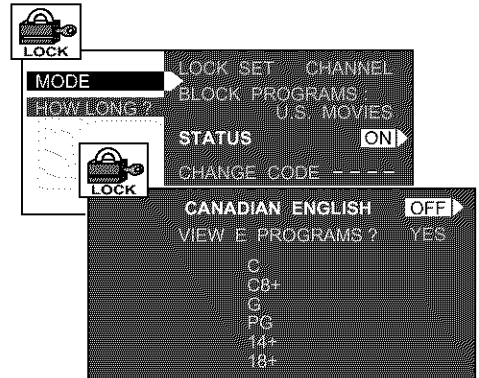

2 Press to select CANADIAN ENGLISH.

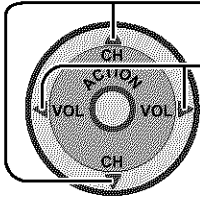

Press to select CANADIAN ENGLISH ON or OFF.
ON ↔ OFF

3 Press to select VIEW E PROGRAMS?

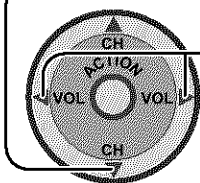

Press to select VIEW E PROGRAMS? YES or NO.
YES ↔ NO

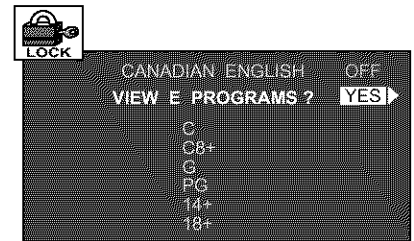

Note:

E (Exempt) programming includes: news, sports, documentaries and other information programming, talk shows, music videos, and variety programming.

4 Press to move between different ratings.

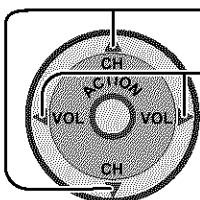

Press to select ratings you would like to block (RED) and unblock (GREEN).

Note: See the CANADIAN ENGLISH RATING CHART.



CANADIAN ENGLISH RATINGS CHART

E	Exempt - Exempt programming includes: news, sports, documentaries and other information programming, talk shows, music videos, and variety programming.
C	Programming intended for children under age 8. No offensive language, nudity or sexual content.
C8+	Programming generally considered acceptable for children 8 years and over. No profanity, nudity or sexual content.
G	General programming, suitable for all audiences.
PG	Parental Guidance suggested. Some material may not be suitable for children.
14+	Programming contains themes or content which may not be suitable for viewers under the age of 14. Parents are strongly cautioned to exercise discretion in permitting viewing by pre-teens and early teens.
18	ADULTS ONLY

Canadian French

The V-CHIP used in this TV model also lets you block or unblock Canadian French programs according to various ratings categories. PIP will also be blocked automatically.

1 In CANADIAN FRENCH press to highlight STATUS.

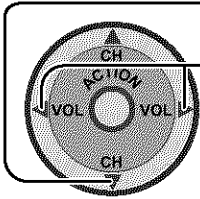

Press to display CANADIAN FRENCH RATING CHART.

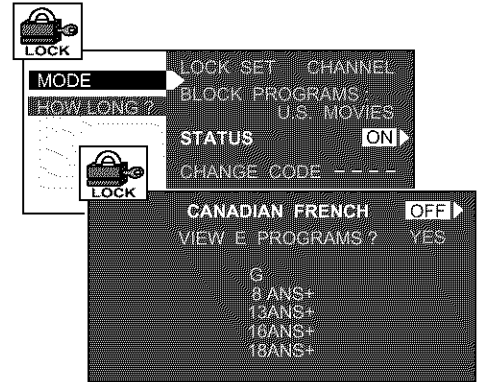

2 Press to select CANADIAN FRENCH.

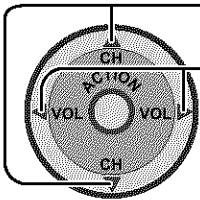

Press to select CANADIAN FRENCH ON or OFF.
ON ↔ OFF



3 Press to select VIEW E PROGRAMS?

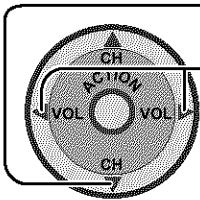

Press to select VIEW E PROGRAMS? YES or NO.
YES ↔ NO

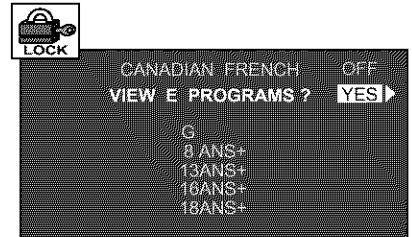

Note:
E (Exempt) programming includes: news, sports, documentaries and other information programming, talk shows, music videos, and variety programming.

4 Press to move between different ratings.

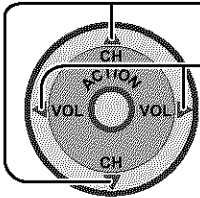

Press to select ratings you would like to block (RED) and unblock (GREEN).

Note: See the CANADIAN FRENCH RATINGS CHART.

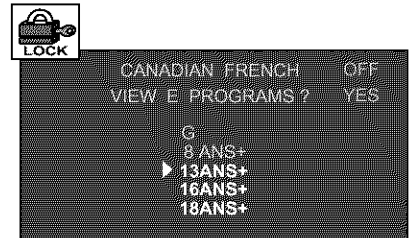

13ANS+, 16ANS+ and 18ANS+ will be blocked.

CANADIAN FRENCH RATINGS CHART

E	Exempt - Exempt programming.
G	General - Programming intended for audience of all ages. Contains no violence, or the violence content is minimal or is depicted appropriately.
8 ans+	8+ General - Not recommended for young children. Programming intended for a broad audience but contains light or occasional violence. Adult supervision recommended.
13ans+	Programming may not be suitable for children under the age of 13 - Contains either a few violent scenes or one or more sufficiently violent scenes to affect them. Adult supervision strongly suggested.
16ans+	Programming may not be suitable for children under the age of 16 - Contains frequent scenes of violence or intense violence.
18ans+	18 ans +Programming restricted to adults. Contains constant violence or scenes of extreme violence.

Blocking Message

If V-Chip is enabled and the program exceeds the rating limit set by you, the blocking message will appear and the audio will be muted. Enter your four-digit secret code if you wish to continue viewing the program. After entering your code, all locks and rating blocks are disabled until the TV is turned off or until all settings are off.

Note:

If you enter your four-digit secret code to override rating blocks, you must reset all rating blocks by either reprogramming or turning the TV off.

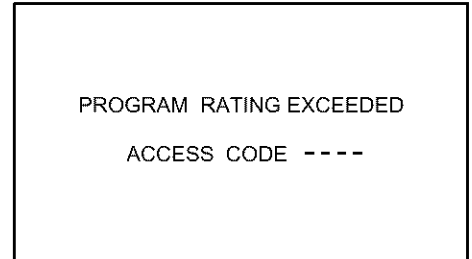

Split Screen Blocking Message

Split Screen function is available when V-Chip is activated. If the program being viewed in Split Screen exceeds the set rating limit, Split Screen will disappear and a blocking message will appear on screen for 5 seconds.

Note:

Enable Split Screen functions by setting Lock Set, U.S. TV PROGRAM, U.S. MOVIES, CANADIAN ENGLISH and/or CANADIAN FRENCH to OFF.

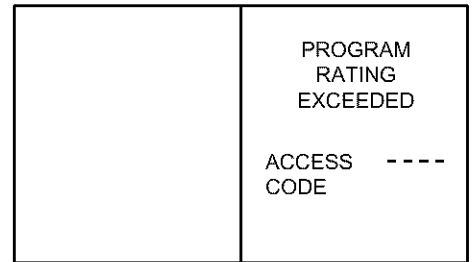

PIP Blocking Message

PIP function is available when V-Chip is activated. If the program being viewed in PIP exceeds the set rating limit, PIP will disappear and a blocking message will appear on screen for 5 seconds.

Note:

Enable PIP functions by setting Lock Set, U.S. TV PROGRAM, U.S. MOVIES, CANADIAN ENGLISH and/or CANADIAN FRENCH to OFF.

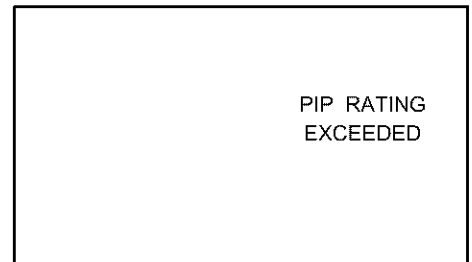

To end Adjustment:

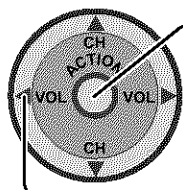

Press twice to return to the roller guide.

Press to exit roller guide.
This returns the set to the normal viewing.

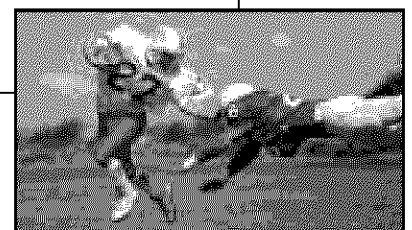
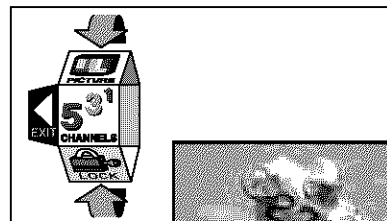

NORMAL PICTURE

Operating peripheral equipment using the remote control

Programming The Illuminated Remote Control Using Access Codes

The Universal Remote Control can be programmed to operate many manufacturers' components, using the component function buttons for VCR, DVD, AUX, RCVR, TV, DTV CABLE or DBS. Follow the procedures for programming your Remote Control with or without a code for the component.

Determine the manufacturer of the component and look in the table for the code.

1 Confirm that the external component is plugged in and operating.

2 Turn the component off.

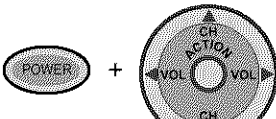
3  Press **POWER** and **ACTION** together, **for at least 5 seconds**. After 5 seconds, all the illuminated mode keys will begin to flash. Release the POWER and ACTION keys.

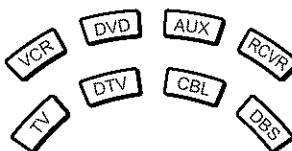
4  Press the mode key. The mode key will illuminate steadily, all others will go out.

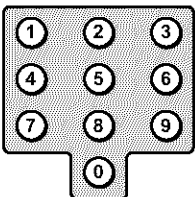
5  Enter the 3-digit component code using the Remote Control numeric keypad.

6  Press the Remote Control  to test the component. If the procedure is successful, the component will turn on.

Default Modes For Remote Control

Device	Operates	Default
TV	TV (Panasonic Only)	Panasonic TV Codes
DTV	DTV (Panasonic Only)	Panasonic DTV Codes
CABLE	CABLE (Preset)	Panasonic CABLE Codes
DBS	DBS (Preset)	Panasonic DBS Codes
VCR	VCR (Preset)	Panasonic VCR Codes
DVD/CD	DVD and CD (Preset)	Panasonic DVD Codes
AUX	Personal Video Recorders, Tape and VCR2	Panasonic Personal Video Recorders Code
RCVR	Audio Receiver (Preset)	Panasonic RCVR Code

Helpful Hints: Unsuccessful Code

If the component does not operate with the Remote Control, repeat the procedure using another code. (Some brands have multiple codes).
If an incorrect code is entered, or if the procedure takes longer than 30 seconds, the programming will fail.

Programming Without A Code (When the code is not known)

This procedure searches all codes and is called the "sequence method."

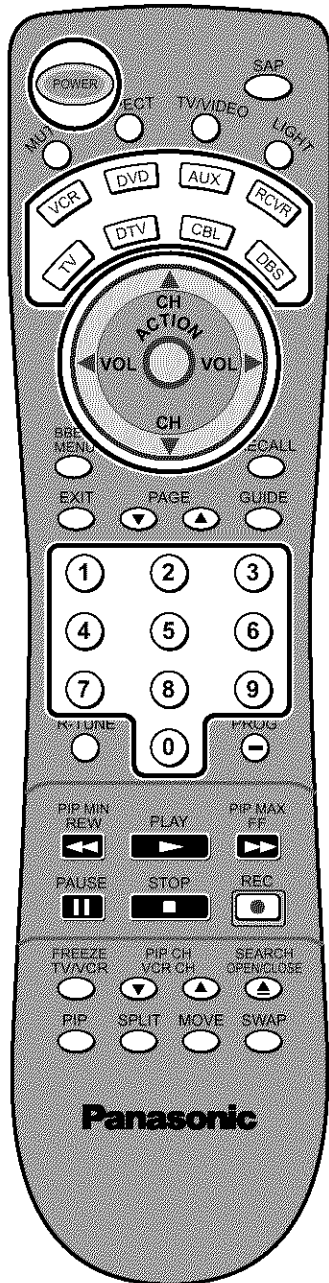

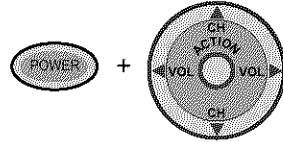

1 Confirm that the external component is plugged in and on.

2 Turn the component off.

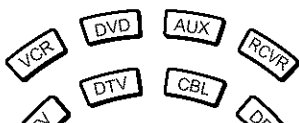
3  Press **POWER** and **ACTION** together, for at least **5 seconds**.
After 5 seconds, all the illuminated mode keys will begin to flash.
Release the **POWER** and **ACTION** key.

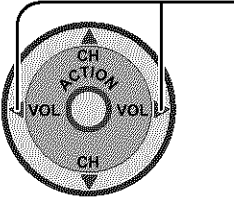
4  Press the mode key.
The mode key will illuminate steadily, all others will go out.

5  Press to move forward to the next code, or to move backward.

6  Press the Remote Control  to test the component. If the procedure was successful, the component will turn on.

Note:

Repeat the above steps until the component code is found. It may take many attempts before the correct code is found.

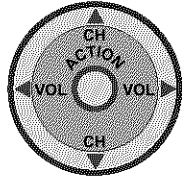
7  After the code is found, press **ACTION** to store the code.

Note:

The step and set mode will start from the current device (not the beginning of the list, except for the first time).

Operating peripheral equipment using the remote control

Infrared Codes Index

The remote control is capable of operating many brands of peripheral equipment. Refer to pages 62 and 63 for programming procedures.

Note: The remote control memory is limited and therefore some models may not operate. The remote control is not designed to control all features available in all models.

Note: After entering the proper infrared code, press the desired Mode Selection Button on the remote control. Refer to pages 16 and 67 - 68 for details on operating peripheral equipment using the remote control.

Infrared Remote Codes for Specific Components

Helpful Hint: Write down the code numbers for your components in the space provided below. This will serve as a handy reference whenever you need to reprogram your remote control.

CABLE Cable Box	<input type="text"/>	VCR Video Cassette Recorder	<input type="text"/>	CD Compact Disc Player	<input type="text"/>
DBS Digital Broadcast System	<input type="text"/>	RCVR Receiver or Amplifier	<input type="text"/>	LD Laser Disc Player	<input type="text"/>
Other Component	<input type="text"/>	Other Component	<input type="text"/>	Other Component	<input type="text"/>
Other Component	<input type="text"/>	Other Component	<input type="text"/>	Other Component	<input type="text"/>

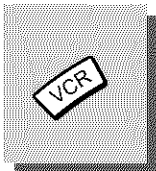

Codes for VCR

Brand	Code
Admiral	335
Aiwa	332
Akai	314, 315, 316, 329
Audio Dynamic	311, 339
Bell & Howell	305, 313
Broksonic	320, 326
Canon	323, 325
Citizen	306
Craig	305, 306, 329
Curtis Mathes	324, 345
Daewoo	301, 324, 343
DBX	310, 311, 339
Dimensia	345
Emerson	303, 319, 320, 325, 326, 343
Fisher	305, 307, 308, 309, 313
Funai	320, 326, 334
GE	324, 333, 345
Goldstar	306
Gradiente	334
Hitachi	300, 323, 345
Instant Replay	323, 324
Jensen	339
JVC	310, 311, 334, 339
Kenwood	306, 310, 311, 339
LXI	300, 305, 306, 307, 308, 309
Magnavox	323, 324, 331
Marantz	310, 311, 339
Marta	306
Memorex	309, 324
MGA	338, 340, 341, 347, 348
Minolta	300, 345
Mitsubishi	338, 340, 341, 347, 348
Multitech	304, 347
NEC	310, 311, 334, 339
Olympic	323, 324
Optimus	306, 321, 328, 335

Brand	Code
Orion	320, 326
Panasonic	321, 322, 323, 324
J.C. Penney	300, 305, 310, 311, 324, 339, 345
Pentax	300, 311, 345
Philco	320, 323, 324, 326, 331, 343
Philips	323, 324, 331
Pioneer	323
Proscan	300, 301, 302, 323, 324, 331, 333, 345, 346
Quasar	321, 322, 323, 324
Radio Shac	305, 309, 324, 333, 336, 340
RCA	300, 301, 302, 323, 324, 331, 333, 345, 346
Realistic	305, 309, 324, 336, 340
Samsung	302, 304, 333
Sansui	320, 326, 339, 352
Sanyo	305, 309, 313
Scott	301, 302, 304, 309, 320, 326, 338, 340, 347, 348
Sears	300, 305, 306, 307, 308
Sharp	335, 336
Shintom	317
Signature 2000	335
Singer	317
Sony	328, 329, 330
Sylvania	323, 324, 331
Tashiro	306
Tatung	310, 311, 339
Teac	310, 311, 339
Technics	321, 322, 323, 324
Teknika	324
Toshiba	301, 346
Vector Research	311
Wards	306, 309, 335, 336, 344
Yamaha	305, 310, 311, 339
Zenith	306, 344

Operating peripheral equipment using the remote control

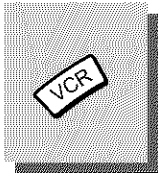

Codes for Personal Video Recorders

Brand	Code
Panasonic Replay	100
Philips Tivo	101
Sony Tivo	102



Codes for DVD

Brand	Code
Denon	100
Ferguson	101
JVC	109
Mitsubishi	105
Nordmende	101
Panasonic	100
Philips	103
Pioneer	102
RCA	101

Brand	Code
Saba	101
Samsung	110
Sharp	108
Sony	104
Technics	100
Thomson	101
Toshiba	103
Yamaha	100
Zenith	107



Codes for CD

Brand	Code
Admiral	226
Aiwa	233, 235
Carver	229
Denon	242
Emerson	239
Fisher	205
Harman/Kardon	219, 220, 221, 223
Hitachi	207
Jensen	234
JVC	240, 241, 245
Kardon	223
Kenwood	200, 201, 211, 245
LXI/Sears	236
Magnavox	229, 232
Marantz	229
McIntosh	221
Nakamichi	210
Onkyo	214, 215

Brand	Code
Optimus	208, 218, 220, 222
Panasonic	224, 225, 227
Philips	229, 230
Pioneer	208
Quasar	224, 225, 227
RCA	231, 237, 238, 247
Sansui	210, 246
Sanyo	205
Scott	210, 246
Sharp	242, 243
Sherwood	220
Sony	228
Soundesign	244
Teac	212, 216, 218
Technics	224, 225, 227
Victor	240, 241, 245
Yamaha	202, 203, 204

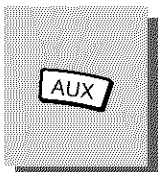

Codes for Cassette Deck

Brand	Code
Aiwa	223, 224, 225
Denon	231
Fisher	203
Jensen	214
JVC	229, 230
Kenwood	200, 207
Marantz	202
Nakamichi	205
Onkyo	208, 209, 213
Panasonic	216, 218

Brand	Code
Philips	222
Pioneer	204
RCA	226, 227, 228
Sansui	205, 210
Sharp	231
Sony	219, 220
Teac	210, 211, 215
Technics	216, 218
Yamaha	201, 202

Operating peripheral equipment using the remote control

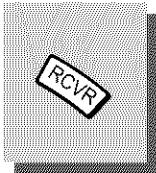

Codes for Receivers

Brand	Code
Admiral	120
Aiwa	125, 126
Denon	134, 135, 136
Fisher	104
Garrard	113
Harman Kardon	115, 123
Jensen	129
JVC	132, 133
Kenwood	100, 108
Magnavox	127
Marantz	124
McIntosh	116
Nakamichi	106
Onkyo	109, 114

Brand	Code
Optimus	103, 127, 130, 131
Panasonic	118, 119, 121
Philips	123
Pioneer	105, 107
Quasar	118, 119, 121
RCA	103, 105, 127, 130, 131
Sansui	103, 111, 139
Sharp	134, 137
Sony	122
Soundesign	138
Teac	111, 112, 113
Technics	118, 119, 121
Victor	132, 133
Yamaha	101, 102

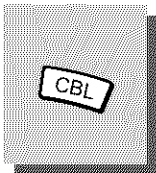

Codes for Cable Box

Brand	Code
ABC	124
Archer	125, 132
Cableview	105, 132
Citizen	105, 122
Curtis	112, 113
Diamond	124, 125, 132
Eagle	129
Eastern	134
GC Brand	105, 132
Gemini	122
General Instrument/Jerrold	111, 119, 120, 121, 122, 123, 124, 125, 126, 127
Hamlin	112, 118, 140, 141, 142, 145
Hitachi	103, 124
Macom	103, 104, 105
Magnavox	133
Memorex	130
Movietime	105, 132
Oak	102, 137, 139
Panasonic	109, 110, 114
Philips	106, 107, 128, 129, 130
Pioneer	101, 116
Pulsar	105, 132

Brand	Code
Puser	132
RCA	115
Realistic	132
Regal	112, 118, 140, 141, 142, 145
Regency	134
Rembrandt	105, 132, 137
Samsung	105
Scientific Atlanta	111, 112, 113
Slmark	101, 105
Sprucer	105, 110
Stargate	105, 132
Tel eview	101, 105
Texscan	144
Tocom	135
Toshiba	104
Unika	125, 132
Universal	122, 132
Videoway	106
Viewstar	129, 130
Zenith	100, 117
Zenith /Drae Satellite	100

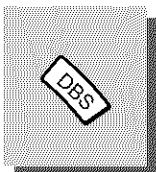

Codes for DBS

















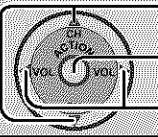



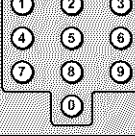



Brand	Code
Dish Network (EchoStar)	105, 115, 116
Echo Star	105
Express VU	105, 115
G.E.	106
G.I.	108
(General Instrument)	
Gradiente	114
Hitachi	103, 111, 112
HNS (Hughes)	103

Brand	Code
Magnavox	101, 102
Panasonic	104
Philips	101, 102
Primestar	108
Proscan	106, 109, 110, 113
RCA	106, 109, 110, 113
Sony	107
Star Choice	103, 108
Toshiba	100
Uniden	101, 102

















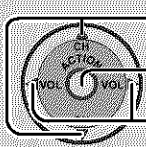





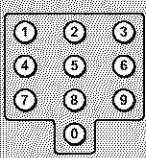



Operating peripheral equipment using the remote control

Mode Operational Key Chart

This chart defines which keys that are operational after programming (if needed), while in the selected remote control mode TV, DTV, CABLE, DBS, VCR, DVD ...etc.











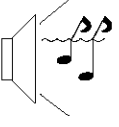

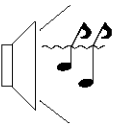
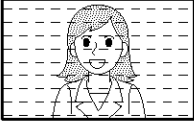
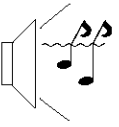
KEY NAME	TV MODE	DTV MODE	CABLE MODE	DBS MODE
	POWER	POWER	POWER	POWER
	SAP ON/OFF	—	—	—
	MUTE	TV MUTE	CBL MUTE	TV MUTE
	TV ASPECT	DTV ASPECT	—	DBS ASPECT
	TV INPUT SW	TV INPUT SW	TV INPUT SW	TV INPUT SW
	REMOTE BUTTONS	REMOTE BUTTONS	REMOTE BUTTONS	REMOTE BUTTONS
	CHANNEL UP/DOWN	NAVIGATION UP/DOWN	CABLE CHANNEL UP/DOWN	DBS NAVIGATION UP/DOWN
	ACTION	ACTION	ENTER	DBS ACTION
	VOL + / -	NAVIGATION RIGHT/LEFT	CABLE VOL + / -	DBS NAVIGATION RIGHT/LEFT
	—	MENU	—	DBS MENU
	DISPLAY	PROGRAM INFO.	TV DISPLAY	DBS PROG.INFO
	—	EXIT (EPG)ELECTRONIC PROGRAM GUIDE	—	DBS EXIT
	—	—	—	DBS PAGE UP/DOWN
	—	GUIDE (EPG)ELECTRONIC PROGRAM GUIDE	—	DBS GUIDE
	Select Channel	Select Channel	Select Channel	Select Channel
	PREVIOUS CHAN OR VIDEO MODE	PREVIOUS STB CHAN	CABLE PREVIOUS	DBS PREVIOUS
	—	DTV PROGRAM/DASH	—	DBS PROGRAM/DASH
	PIP MINIMIZE/ MAXIMIZE	—	—	—
	—	—	—	—
	—	—	—	—
	—	—	—	—
	—	Info (EPG) ELECTRONIC PROGRAM GUIDE	VCR RECORD	DBS RECORD
	PIP FREEZE	—	—	TV/DBS SWITCH
	PIP or SPLIT CHAN UP/DOWN	—	TV CHANNEL UP/DOWN	DBS CHANNEL UP/DOWN
	PIP SEARCH	—	—	—
	PIP ON/OFF	—	—	—
	SPLIT ON/OFF	—	—	—
	MOVE PIP	—	—	—
	PIP or SPLIT SWAP	—	—	—

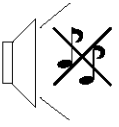
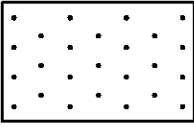
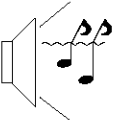
Operating peripheral equipment using the remote control

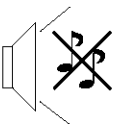
KEY NAME	VCR MODE	DVD MODE		AUX MODE		RCVR MODE
		(DVD)	(CD)	(VCR2)	(TAPE)	
	POWER	POWER	POWER	POWER	POWER	POWER
	—	—	—	—	—	—
	TV MUTE	TV MUTE	RCVR MUTE	TV MUTE	RCVR MUTE	RCVR MUTE
	—	—	—	—	—	—
	TV INPUT SW	TV INPUT SW	—	TV INPUT SW	TV INPUT SW	TV INPUT SW
	REMOTE BUTTONS	REMOTE BUTTONS	REMOTE BUTTONS	REMOTE BUTTONS	REMOTE BUTTONS	REMOTE BUTTONS
	VCR CHAN UP/DOWN	NAVIGATION UP/DOWN	NEXT/PREVIOUS TRACK	VCR CHANNEL UP/DOWN	—	TUNER +/-
	TV ACTION	SELECT	—	TV ACTION	—	—
	TV VOLUME +/-	NAVIGATION UP/DOWN	RCVR VOLUME UP/DOWN	TV VOLUME +/-	RCVR VOLUME +/-	RCVR VOLUME +/-
	—	DVD MENU	—	—	—	—
	ONSCREEN VCR DISPLAY	DVD DISPLAY	TIME FORMAT	ONSCREEN VCR DISPLAY	—	—
	—	—	—	—	—	—
	—	SKIP +/-	SKIP +/-	—	—	—
	—	TITLE	NEXT TRACK	—	—	—
	Select Channel	Select Chapter Number	Select Track Number	Select Channel	—	1.... AV1 2.... AV2 3.... AV3 4.... AV4 5.... CD 6.... TUNER 7.... PHONO 8.... TAPE 9.... AUX
	—	—	—	—	DECK A/B	—
	—	—	—	—	—	—
	VCR REW/FF	SKIP SEARCH <<REW/>>FF	SEARCH REW/FF	VCR REW/FF	TAPE REW/FF	SURROUND -/+
	PLAY	PLAY	PLAY	PLAY	PLAY	—
	PAUSE	PAUSE	PAUSE	PAUSE	PAUSE	—
	STOP	STOP	STOP	STOP	STOP	—
	VCR RECORD	—	—	VCR RECORD	TAPE RECORD	—
	TV/VCR SWITCH	—	—	TV/VCR SWITCH	—	—
	VCR CHANNEL UP/DOWN	—	—	VCR CHANNEL UP/DOWN	—	—
	—	OPEN/CLOSE	OPEN/CLOSE	—	OPEN/CLOSE	—
	—	—	—	—	—	—
	—	—	—	—	—	—
	—	—	—	—	—	—
	—	—	—	—	—	—

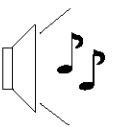
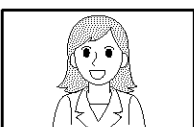
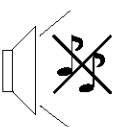

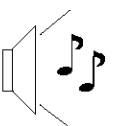
Troubleshooting Chart

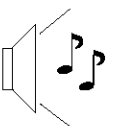
Before calling for service, determine the symptoms and follow suggested solutions.

Symptoms		Solutions
VIDEO	AUDIO	
 Snowy Video	 Noisy Audio	Adjust Antenna Location and Connection
 Multiple Image	 Noisy Audio	Adjust Antenna Location and Connection Check Antenna Lead-in Wire
 Interference	 Noisy Audio	Move Television away from Electrical Appliances, Lights, Vehicles and Medical Equipment
 Normal Video	 No Audio	Increase Volume Check Mute Check Television SPEAKERS on/off Change Channel
 No Video with Snow	 Noisy Audio	Set TV or Cable Mode Properly Check Antenna Cables
 No Video / No PIP	 No Audio	Check Power Cord is Plugged into Active Outlet Adjust Brightness and Audio Controls Change Channel Check Cable Connections Program the Remote Control Again Check Second Video Source Operation
 No Color	 Normal Audio	Adjust Color Settings Change Channel
 Normal Video	 Wrong Audio	Check Audio Is Set To Stereo or Mono, Not SAP
 Black Box on Screen	 Normal Audio	Change CC (Closed Captioning) from Text Mode
 Normal Video	 Normal Audio	Replace Remote Control Batteries
Intermittent Remote Control Operation		

Cleaning

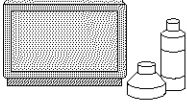
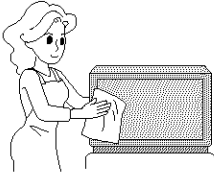
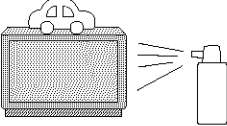
To ensure continued excellent performance by this product, periodic cleaning is recommended.

	<p>The unit contains many plastic parts. For this reason DO NOT use benzine, thinner or other chemicals to clean the unit.</p>		<p>Dust will accumulate on the picture screen. Please wipe with a soft cloth from time to time. If you use a chemically treated cloth, please be careful to follow the instructions that come with the cloth.</p>
	<p>DO NOT bring into contact with insecticide or other volatile substances. DO NOT allow the unit to come into contact for extended periods with rubber or vinyl products.</p>		<p>Remove dirt and soiling by wiping with a light cloth. Even if the unit is heavily soiled, do not apply cleaner directly to the unit. Soak a cloth in a solution of neutral cleanser thinned with water. Then wring out the cloth, wipe the unit clean, and finish by wiping with a dry cloth.</p>

Specifications

		CT-30WX52	CT-34WX52
Power Source		AC 120 V, 60 Hz	AC 120 V, 60 Hz
Power Consumption		Average use : 170 W (Maximum Current 3.6 A) Stand-by condition : 0.2 W	Average use : 170 W (Maximum Current 3.6 A) Stand-by condition : 0.2 W
CRT		30-inch, 16 : 9 aspect ratio	34-inch, 16 : 9 aspect ratio
Screen Size		25.95 " (659.1 mm) (W) × 14.59 " (370.7 mm) (H) × 29.77 " (756.2 mm) (diagonal)	29.36 " (745.9 mm) (W) × 16.5 " (419.5 mm) (H) × 33.68 " (855.7 mm) (diagonal)
Dimensions (W × H × D)		32.6 " (827 mm) × 22.8 " (579 mm) × 21.1 " (535 mm)	36.4 " (926 mm) × 30.6 " (651 mm) × 23.1 " (584 mm)
Mass (Weight)		126 lb. (57 kg) Net	172 lb. (78 kg) Net
Channel Capability-181		VHF-12 : UHF-56 : Cable-125	
Sound	Speaker	4 Speakers	
	Audio Output	30 W [15 W + 15 W] (10 % THD)	
	Headphones	M3 (3.5 mm) Jack × 1	
FEATURES		Two screen display fuctions BBE CLOSED CAPTION	3D Y/C FILTER LINEAR PIP V-Chip
Accessories Supplied		Remote control Transmitter R6 (AA) Battery × 2	EUR7603Z70
Operating Conditions		Temperature : 34 °F - 104 °F (0 ° - 40 °C) Humidity : 20 % - 80 % (non-condensing)	
Connection Terminals		AV INPUT 1- 4	VIDEO (Phono Jack Type) S-VIDEO (Mini DIN 4-pin) AUDIO L-R (Phono Jack Type × 2) 1.0 Vp-p (75 Ω) Y : 1.0 Vp-p (75 Ω), C : 0.286 Vp-p (75 Ω) 0.5 Vrms
		AV PROG. OUT	VIDEO (Phono Jack Type) AUDIO L-R (Phono Jack Type × 2) 1.0 Vp-p (75 Ω) 0.5 Vrms
		TO AUDIO AMP	AUDIO L-R (Phono Jack Type × 2) 0.5 Vrms
		COMPONENT VIDEO INPUT1-2	Y P _B / P _R AUDIO L-R (Phono Jack Type × 2) 1.0 Vp-p (including synchronization) ± 0.35 Vp-p 0.5 Vrms

Note:

Design and Specifications are subject to change without notice. Weight and Dimensions shown are approximate.

Customer's Record

The model number and serial number of this product can be found on its back cover. You should note this serial number in the space provided below and retain this book, plus your purchase receipt, as a permanent record of your purchase to aid in identification in the event of theft or loss, and for Warranty Service purposes.

Model Number _____

Serial Number _____

**Panasonic Consumer Electronics
Company, Division of Matsushita
Electric Corporation of America**
One Panasonic Way Secaucus,
New Jersey 07094

**Panasonic Sales Company,
Division of Matsushita Electric
of Puerto Rico Inc. ("PSC")**
Ave. 65 de Infanteria, Km 9.5
San Gabriel Industrial Park,
Carolina, Puerto Rico 00985

Panasonic Canada Inc.
5770 Ambler Drive
Mississauga, Ontario
L4W 2T3