

## Operating instructions Microwave oven



To avoid the risk of accidents or damage to the appliance it is **essen-  
tial** to read these instructions before it is installed and used for the  
first time.

# Contents

---

<b>Warning and Safety instructions</b> .....	4
<b>Before using for the first time</b> .....	14
<b>Setup and connection</b> .....	15
Electrical connection .....	16
<b>Caring for the environment</b> .....	17
<b>Guide to the appliance</b> .....	18
<b>Accessories supplied</b> .....	19
<b>Control panel</b> .....	20
<b>Description of function</b> .....	21
<b>Modes of operation</b> .....	22
Functions .....	22
Microwave Solo mode .....	22
Grilling .....	22
Combination mode (Microwave + Grill) .....	22
Automatic programmes .....	22
<b>Suitable containers for microwave ovens</b> .....	23
Material and shape .....	23
Testing containers .....	25
A heat-retaining cover .....	26
<b>Before using for the first time</b> .....	27
Setting the time .....	27
Altering the time of day .....	27
Switching off the time of day display .....	27
Night switch-off .....	27
<b>Operation</b> .....	28
Opening the door .....	28
Placing the dish in the oven .....	28
Turntable .....	28
Closing the door .....	28
Starting a programme .....	28
“door” message .....	29
Interrupting or re-starting a programme .....	29
Altering settings .....	30
Cancelling a programme .....	30
At the end of a programme .....	30

---

Automatic keeping-warm function .....	30
Quick start (programmable).....	31
System lock.....	31
Using the minute minder .....	32
Altering a minute minder entry .....	32
Minute minder + cooking function .....	32
<b>Operation – grilling .....</b>	<b>33</b>
<b>Gourmet plate .....</b>	<b>35</b>
Tips for use.....	35
Searing/browning food.....	35
Examples of use:.....	36
Recipes.....	36
<b>Operation - Automatic programmes.....</b>	<b>39</b>
Automatic defrosting .....	39
Automatic cooking .....	39
<b>Recipes for automatic programmes.....</b>	<b>41</b>
<b>Saving your favourite programme (Memory) .....</b>	<b>47</b>
<b>Changing settings .....</b>	<b>48</b>
<b>Reheat .....</b>	<b>50</b>
<b>Cooking .....</b>	<b>52</b>
<b>Defrost.....</b>	<b>53</b>
<b>Examples of use .....</b>	<b>54</b>
<b>Note for test institutes .....</b>	<b>55</b>
<b>Cleaning and care .....</b>	<b>56</b>
Accessories supplied .....	58
<b>Problem solving guide .....</b>	<b>59</b>
<b>After sales service.....</b>	<b>62</b>
Contact in case of malfunction .....	62
Warranty .....	62

## Warning and Safety instructions

---

This microwave oven complies with current safety requirements. Inappropriate use can, however, lead to personal injury and material damage.

Read the operating instructions carefully before using the appliance. They contain important information on the installation, safety, use and maintenance of the appliance. This prevents both personal injury and damage to the appliance.

In accordance with standard IEC/EN 60335-1, Miele expressly and strongly advises that you read and follow the instructions in the chapter on installing the appliance as well as the safety instructions and warnings.

Miele cannot be held liable for injury or damage caused by non-compliance with these instructions.

Keep these operating instructions in a safe place and pass them on to any future owner.

### Correct application

- ▶ This microwave oven is intended for private domestic use. This appliance is not intended for outdoor use.
- ▶ Do not use the appliance at altitudes of above 2000 m.
- ▶ The microwave oven is intended for domestic use only to cook, defrost and to reheat food. Any other use is not permitted.
- ▶ Do not use the microwave oven to store or dry items which could ignite easily. If such items were dried in the microwave oven, the moisture in the item would evaporate causing it to dry out and even self-ignite. Never use the microwave oven to store or dry items which could ignite easily.
- ▶ This microwave oven can only be used by people with reduced physical, sensory or mental capabilities or lack of experience and knowledge if they are supervised whilst using it. They may only use it unsupervised if they have been shown how to use it in a safe way. They must be able to recognise and understand the consequences of incorrect operation.

## Warning and Safety instructions

---

- ▶ The oven compartment is fitted with a special lamp to cope with particular conditions (e.g. temperature, moisture, chemical resistance, abrasion resistance and vibration). This special lamp must only be used for the purpose for which it is intended. It is not suitable for room lighting. Replacement lamps may only be fitted by a Miele authorised technician or by the Miele Customer Service Department.
- ▶ The microwave oven contains 1 light source corresponding to energy efficiency class E.

### Safety with children

- ▶ Children under eight years of age must be kept away from the appliance unless they are constantly supervised.
- ▶ Children aged eight and older may only use the microwave oven without supervision if they have been shown how to use it in a safe manner. Children must be able to recognise and understand the potential risks of improper use.
- ▶ Children must not be allowed to clean or maintain the appliance unsupervised.
- ▶ Children should be supervised in the vicinity of the microwave oven. Never allow children to play with the appliance.
- ▶ Danger of suffocation! Whilst playing, children could become entangled in packaging (such as plastic wrapping) or pull it over their head and suffocate. Keep packaging material away from children.
- ▶ Danger of burning. Children's skin is far more sensitive to high temperatures than that of adults. When grilling with or without the microwave function, the oven interior, grill element and door can get hot. Do not let children touch the microwave oven when it is in operation.

### Technical safety

- ▶ A damaged appliance could be dangerous. Check the appliance for visible signs of damage. Do not use the appliance if it is damaged.

## Warning and Safety instructions

---

▶ If the electrical connection cable is faulty, it must only be replaced by a Miele authorised technician to protect the user from danger.

▶ Temporary or permanent operation on an autonomous power supply system or a power supply system that is not synchronised with the mains power supply (e.g. island networks, back-up systems) is possible. A prerequisite for operation is that the power supply system complies with the specifications of EN 50160 or an equivalent standard.

The function and operation of the protective measures provided in the domestic electrical installation and in this Miele product must also be maintained in isolated operation or in operation that is not synchronised with the mains power supply, or these measures must be replaced by equivalent measures in the installation. As described, for example, in the current version of BS OHSAS 18001–2 ISO 45001.

▶ Operating a damaged appliance can result in microwave leakage and present a hazard to the user. Do not use the appliance if

- the appliance door is warped.
- the door hinges are loose.
- holes or cracks are visible in the casing, the door or the oven interior walls.

▶ Any contact with live connections or tampering with the electrical or mechanical components of the microwave oven will endanger your safety and may lead to appliance malfunctions. Do not open the appliance housing under any circumstances.

▶ Before connecting the appliance to the mains supply, ensure that the connection data on the data plate (voltage and frequency) match the mains electricity supply. This data must correspond in order to avoid the risk of damage to the appliance. Compare this before connecting the appliance to the mains. Consult a qualified electrician if in any doubt.

▶ Multi-socket adapters and extension leads do not guarantee the required safety of the appliance (fire hazard). Do not use them to connect the appliance to the mains.

## Warning and Safety instructions

---

- ▶ The electrical safety of this microwave oven can only be guaranteed when continuity is complete between it and an effective earthing system. It is essential that this standard safety requirement is met to avoid the risk of damage or electric shock. If in any doubt, please have the electrical installation tested by a qualified electrician.
- ▶ Do not situate the appliance too close to an adjacent furniture unit. To ensure adequate ventilation, a minimum of gap of 5 cm is required between the appliance and any neighbouring furniture or walls. There must be a minimum gap of 19.5 cm between the top of the appliance and anything above it.
- ▶ Unauthorised or incorrect repairs can cause considerable danger to users. Repairs may only be carried out by a Miele authorised technician or by the Miele Customer Service Department.
- ▶ While the microwave oven is under warranty, repairs should only be undertaken by a Miele authorised service technician. Otherwise the warranty is invalidated.
- ▶ The microwave oven must be disconnected from the mains power supply during repairs or cleaning and maintenance. It is only completely isolated from the electricity supply when:
  - the plug has been disconnected from the back of the appliance or the appliance has been switched off at the wall socket and the plug withdrawn.Pull by the plug and not by the mains connection cable to disconnect your appliance from the mains electricity supply.
  - the mains circuit breaker is switched off.
  - the mains screw-out fuse is removed (in countries where this is applicable).
- ▶ Miele can only guarantee the safety of the appliance when genuine original Miele replacement parts are used. Faulty components must only be replaced by genuine Miele original spare parts.

## Warning and Safety instructions

---

- ▶ If the appliance is installed behind a kitchen furniture door, it may only be used with the furniture door open. Do not close the furniture door while the appliance is in use. Heat and moisture can build up behind the closed furniture door. This can result in damage to the appliance and furniture unit. Leave the furniture front/door open until the appliance has cooled down completely.
- ▶ If your microwave oven is built in with a lift-up door: do not bring the door down into the closed position when the oven is in operation.
- ▶ The appliance must not be used in a non-stationary location (e.g. on a ship).

### Correct use

 Risk of burning due to the grill.

When grilling with or without the microwave function, the microwave oven can get hot. You could burn yourself on the oven compartment, the grill element, food, accessories or the appliance door.

Use oven gloves when placing hot food in the appliance or removing it and when working in the hot oven compartment.

- ▶ Always ensure that food is sufficiently cooked or reheated. The time required for this depends a number of factors, such as the nature of the food, its initial temperature and the amount to be cooked and recipe variations. Some foods may contain micro-organisms which are only destroyed by thorough cooking at temperatures over 70 °C for a minimum of 10 minutes. Therefore when cooking or reheating foods, e.g. poultry, it is particularly important that food is fully cooked through. If in any doubt that a sufficiently high temperature has been reached, continue reheating for a little longer.

## Warning and Safety instructions

---

- ▶ It is important that the temperature in the food being cooked is evenly distributed and sufficiently high. This can be achieved by stirring or turning the food, and observing a sufficiently long standing time (see charts), which should be added to the time needed for reheating, defrosting or cooking. During the standing time the temperature is distributed evenly in the food.
- ▶ Always remember that times for cooking, reheating and defrosting in a microwave oven are usually considerably shorter than with traditional methods of cooking food. Excessively long cooking times can lead to food drying out and burning, or could even cause it to catch fire. Fire hazard. There is also a danger of fire if breadcrumbs, flowers, herbs, etc., are dried in the microwave oven. Do not dry these items in the microwave oven.
- ▶ Cushions or pads filled with cherry kernels, wheat grain, lavender or gel, such as those used in aromatherapy can ignite when heated even after they have been removed from the microwave oven. Do not heat these up in the microwave oven. Fire hazard.
- ▶ The microwave oven is not suitable for cleaning or disinfecting items. Items can get extremely hot and there is a danger of burning when the item is removed from the appliance. Fire hazard.
- ▶ The appliance can be damaged if it is used without food being placed in it or if it is incorrectly loaded. Therefore do not use the appliance to preheat crockery or to dry herbs or similar items.
- ▶ Always ensure that food or a suitable microwave browning dish has been placed in the microwave oven and that the turntable is in position before switching on.
- ▶ Pressure can build up when reheating in sealed containers, causing the container to explode. Never cook or reheat food or liquids in sealed containers, jars or bottles. With baby bottles, the screw top **and** teat must be taken off.

## Warning and Safety instructions

---

▶ Be careful when removing dishes from the appliance. Although heat is not normally produced in the container itself by the microwaves (apart from stoneware), heat transfer from the food to the container may be considerable, making the container itself hot. The dish is only warmed by the heat of the food. Before serving, always check the temperature of the actual food itself after taking it out of the microwave. The temperature of the container is not an indication of the temperature of the food or liquid in it. **This is particularly important when preparing food for babies, children, and the elderly or infirm.** After reheating food, especially food for babies and small children, stir the food or shake the container and check that the temperature does not pose any danger. Double check after it has been left to stand.

▶ When heating liquids, milk, sauces etc, using microwave power, the boiling point of the liquid may be reached without the production of typical bubbles. The liquid does not boil evenly throughout. This so-called 'boiling delay' can cause a sudden build-up of bubbles when the container is removed from the oven or shaken, which can lead to the liquid boiling over suddenly and explosively. Danger of burning. The formation of bubbles can be so strong that the pressure forces the oven door open. Danger of injury and damage to the appliance. Stir liquids well before heating. After heating, wait at least 20 seconds before removing the container from the oven. In addition, during heating a glass rod or similar item, if available, can be placed in the container.

▶ To avoid fuelling any flames, do not open the oven door if smoke occurs inside the appliance. Interrupt the process by switching the appliance off and disconnect it from the mains electricity supply. Do not open the door until the smoke has dispersed.

▶ Oils and fats can ignite if allowed to overheat. Never leave the microwave oven unattended when cooking with oil or fats. Do not use the appliance for deep-fat frying. Never attempt to put out oil or fat fires with water. Switch the oven off and extinguish the flames by leaving the door closed.

## Warning and Safety instructions

---

▶ Due to the high temperatures radiated, objects left near the microwave oven when it is in use could catch fire. Do not use the appliance to heat up the room.

▶ If using alcohol in your recipes, please be aware that high temperatures can cause the alcohol to vaporise. The vapour can catch fire on hot surfaces. Never heat undiluted alcohol in the microwave, as this can easily ignite. Fire hazard.

▶ Food which is stored in the oven or left in it to be kept warm can dry out and the moisture released can lead to corrosion damage in the microwave oven. This can also cause damage to the control panel, worktop and surrounding kitchen furniture. Always cover food that is left in the oven to keep warm.

▶ Try to avoid the interior walls being splashed with food or liquids containing salt. If it does happen, wipe these away thoroughly to avoid corrosion to stainless steel surfaces inside the cabinet.

▶ The oven interior can get hot during use. Danger of burning! Clean the oven interior and accessories as soon as it has cooled down. Waiting too long can make cleaning unnecessarily difficult and in some cases impossible. Stubborn soiling could damage the microwave oven in certain circumstances and could even be dangerous. Fire hazard.

Please refer to the relevant instructions in "Cleaning and care".

▶ Fire hazard. Plastic containers which are not suitable for use in microwave ovens can be badly damaged and cause damage to the appliance if used. Do not use any containers or cutlery made from or containing metal, aluminium foil, lead crystal glassware, temperature-sensitive plastics, wooden utensils or cutlery, metal clips or plastic or paper covered wire ties. Do not use bowls with milled rims, or plastic pots with the foil lid only partially removed (see "Suitable containers for microwave use").

Using these items could result in damage to the container or present a fire risk.

## Warning and Safety instructions

---

▶ Only those plastic disposable containers which are specified by the manufacturer as suitable for use in a microwave oven may be used. Do not leave the oven unattended when heating or cooking food in disposable containers made of plastic, paper or other inflammable materials.

▶ Heat-retaining packaging consists of, among other things, a thin layer of aluminium foil. Microwaves are reflected by metal. This reflected energy can, in turn, cause the outer paper covering to become so hot that it ignites.

Do not use heat-retaining packaging, such as bags for grilled chicken for warming food in the microwave oven.

▶ If you cook eggs without their shells using microwave power, the yolks could explode due to the resulting pressure. Prick the yolk several times before cooking to avoid this.

▶ Eggs heated in their shells using microwave power can burst, even after they have been taken out of the oven. Eggs can only be cooked in their shells in a specially designed egg-boiling device. Do not reheat hard-boiled eggs in the microwave oven.

▶ Food with a thick skin or peel, such as tomatoes, sausage, potatoes and aubergines can burst when heated. Pierce or score the skin of these types of food several times to allow steam to escape.

▶ Dishes with hollow knobs or handles are not suitable for use with microwave power. Moisture which has gathered in the hollow recesses can cause pressure to build up and the item can explode. If the hollow recess is sufficiently ventilated, the item could be used. However, we recommend that you do not use such dishes in the microwave oven.

▶ Do not use a thermometer containing mercury or liquid as these are not suitable for use with very high temperatures and break very easily.

To check food temperature, first interrupt the cooking process. Only use a thermometer specifically approved for food use to measure the temperature of the food.

## Warning and Safety instructions

---

▶ The steam from a steam cleaning appliance could reach live electrical components and cause a short circuit. Do not use a steam cleaner to clean the appliance.

**The following applies for stainless steel surfaces:**

▶ The surface is susceptible to scratching. Even magnets can cause scratches.

### Accessories

▶ Only use original Miele accessories. If other parts are used, warranty, performance and product liability claims will be invalidated.

▶ Miele will guarantee to supply functional spare parts for a minimum of 10 years and up to 15 years following the discontinuation of your microwave oven.

▶ The rack and gourmet plate supplied are designed for use with microwave power and can be used for grilling with or without the microwave function.

They must not, however, be used at the same time as this would damage the gourmet plate. Always place the gourmet plate directly on the turntable.

▶ The gourmet plate gets extremely hot when in use. Always use oven gloves when handling it to avoid burns. Place it on a suitable heat-resistant mat or pot rest.

The rack and glass tray get hot during grilling (with and without the microwave function).

Danger of burning.

▶ Do not use the gourmet plate together with a commercially available, microwave-safe heat-retaining cover because the cover will get too hot.

## Before using for the first time

After transportation, let the unpacked appliance stand for approx. 2 hours at room temperature before using it.

This is to allow time for the temperature to equalise between the temperature in the room and the appliance. This is important for the correct electronic functioning of the appliance.

**⚠** Risk of suffocation due to packaging material.

Whilst playing, children may become entangled in packaging material (such as plastic wrapping) or pull it over their head, presenting the risk of suffocation.

Keep packaging material away from children.

- Remove all the packaging materials and any protective film from the appliance.

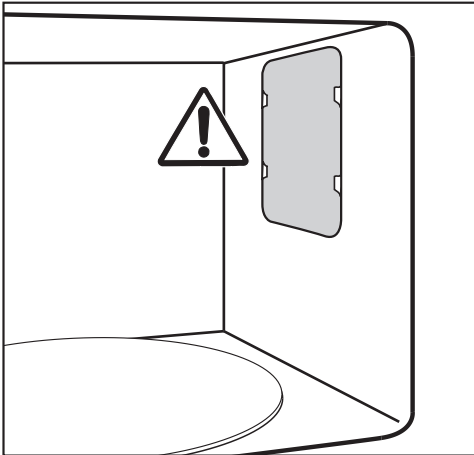

Do not remove the cover from the microwave outlet inside the oven compartment or the film on the inside of the door.

- Check the appliance for any damage.

**⚠** Health risk caused by a faulty appliance.

Operating a damaged appliance can result in microwave leakage and present a hazard to the user.

Do not use the microwave oven if:

- the appliance door is warped.
- the door hinges are loose.
- holes or cracks are visible in the casing, the door or the oven interior walls.

- Clean the oven compartment and all the accessories with a sponge or cloth and hot water.

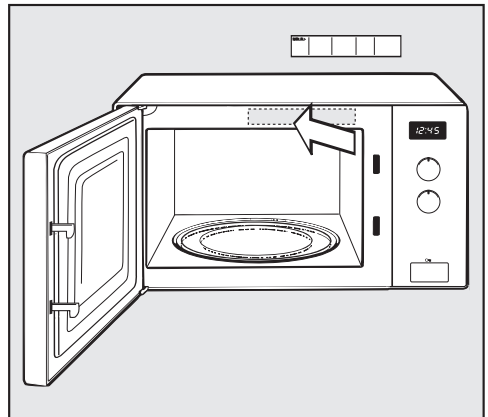

- Stick the enclosed short instructions to the frame behind the door as illustrated, making sure they do not block any of the vents.

## Setup and connection

When installing the microwave oven ensure that there is unhindered ventilation to and from the appliance both underneath and to the rear.

Do not block the ventilation gaps or block the gap between the base of the appliance and the worktop surface.

A minimum installation height of 85 cm must be maintained.

The microwave oven can be placed on a worktop.

To ensure adequate ventilation, a minimum of gap of 5 cm is required between the appliance and any neighbouring furniture or walls. There must be a minimum gap of 19.5 cm between the top of the appliance and anything above it.

Do not situate the appliance too close to an adjacent furniture unit.

Heat and moisture can build up if the microwave oven is installed behind a closed furniture door. This can result in damage to the appliance and furniture unit.

The microwave oven may only be used with the furniture door open.

Do not close the furniture door while the appliance is in use.

Leave the furniture front/door open until the appliance has cooled down completely.

If your microwave oven is built in with a lift-up door: do not bring the door down into the closed position when the oven is in operation.

# Setup and connection

## Electrical connection

 Risk of injury caused by a faulty appliance.

Before connecting the appliance, ensure that it has not been damaged in any way.

Never use a faulty appliance.

The appliance is supplied ready for connection with a cable and plug.

Ensure that the protective contact socket is easily accessible at all times. If that is not possible, ensure that a suitable means of disconnection is provided on the installation side for each pole.

 Fire hazard due to overheating.

Connecting the appliance to a multi-socket plug adapter or to an extension lead can overload the cable.

The appliance must not be used with so-called energy-saving devices.

These reduce the amount of energy supplied to the appliance, causing it to overheat.

For safety reasons, do not use an extension lead or multi-socket plug adapter.

Connect the appliance directly to the power supply using the original cable and do not use any intermediate elements.

The electrical installation must comply with VDE 0100 requirements and local regulations (e.g. BS 7671 in the UK).

If the connection cable is damaged, it must only be replaced with a specific connection cable of the same type (available from the Miele Customer Service Department). For safety reasons, such replacement may only be carried out by a qualified technician or the Miele Customer Service Department.

The necessary connection data can be found on the data plate located on the front of the oven interior or on the back of the appliance.

Compare the specifications on the data plate with those of the electricity supply. Make sure that they match.

If in any doubt, consult a qualified electrician.

Temporary or permanent operation on an autonomous power supply system or a power supply system that is not synchronised with the mains power supply (e.g. island networks, back-up systems) is possible. A prerequisite for operation is that the power supply system complies with the specifications of EN 50160 or an equivalent standard.

The function and operation of the protective measures provided in the domestic electrical installation and in this Miele product must also be maintained in isolated operation or in operation that is not synchronised with the mains power supply, or these measures must be replaced by equivalent measures in the installation. As described, for example, in the current version of BS OHSAS 18001–2 ISO 45001.

### Disposing of the packaging material

The packaging material is used for handling and protects the appliance from transport damage. The packaging material used is selected from materials which are environmentally friendly for disposal and can generally be recycled.

Recycling the packaging material reduces the use of raw materials. Use material-specific collection points for valuable materials and take advantage of return options. Your Miele dealer will take the packaging material away.

### Disposing of your old appliance

Electrical and electronic appliances contain many valuable materials. They also contain certain materials, compounds and components which were essential for their correct functioning and safety. These could be hazardous to human health and to the environment if disposed of with household waste or if handled incorrectly. Please do not, therefore, dispose of your old appliance with household waste.



Instead, please make use of officially designated collection and disposal points to dispose of and recycle electrical and electronic appliances in your local community, with your dealer or with Miele, free of charge. By law, you are solely responsible for deleting any personal data from the old appliance prior to disposal. You are legally obliged to remove any old batteries which are not securely enclosed by the appliance and to remove any lamps without destroying them, where this is possible. These must be taken to a suitable collection point where they can be handed in free of charge. Please ensure that your old appliance poses no risk to children while being stored for disposal.

# Guide to the appliance

---

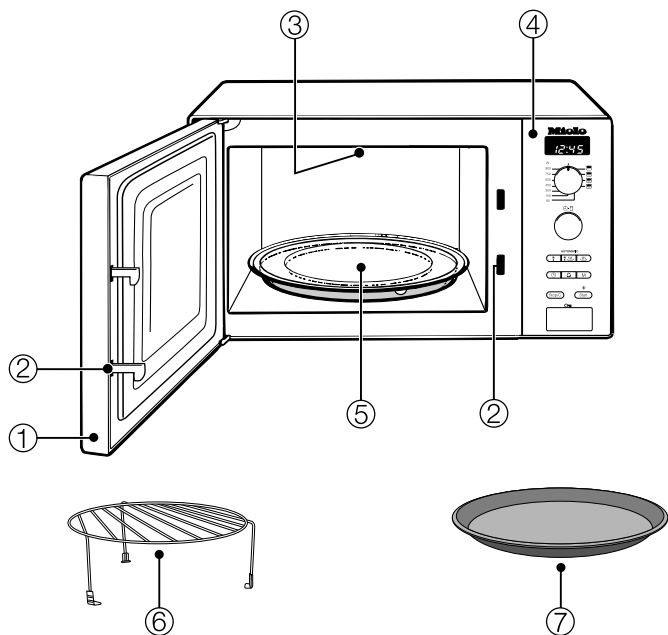

- ① Door
- ② Door lock
- ③ Grill
- ④ Control panel
- ⑤ Turntable
- ⑥ Grilling rack
- ⑦ Gourmet plate

### Grilling rack

The grilling rack can be used for all functions with and without microwave power, **except** for Microwave Solo mode.

To avoid the grilling rack being used inadvertently with Microwave Solo, it should not be stored inside the oven compartment.

### Gourmet plate

The gourmet plate is a round, non-stick grilling plate. It can be used to heat snacks or small meals quickly whilst maintaining crispness.

**Tip:** These products and other accessories can be ordered through the Miele Webshop.

They can also be ordered from Miele (see end of this booklet for contact details) or from your Miele dealer.

# Control panel

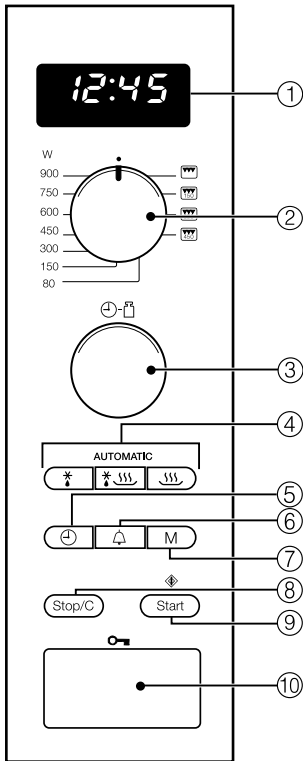

- ① Display for showing the time of day and information on operation
- ② Rotary selector for microwave power, grill and combination programmes
- ③ Rotary selector to enter time and weight
- ④ Automatic programmes
- ⑤ Time of day
- ⑥ Minute minder
- ⑦ Memory button (to save a 1–3 stage programme sequence)
- ⑧ Stop/Cancel button
- ⑨ Start/Add a minute/Quick start (programmable)
- ⑩ Door release

The microwave oven contains a magnetron. This converts electrical energy into electromagnetic waves (microwaves). These microwaves are distributed evenly throughout the oven compartment, and are reflected off the metal appliance walls. This enables the microwaves to reach the food from all sides and heat it up. Microwave distribution is improved with the turntable engaged.

In order for microwaves to reach the food, they must be able to penetrate the cooking container being used. Microwaves can pass through porcelain, glass, cardboard and plastics, but not metal. Do not, therefore, use containers made of metal, or which contain metal, for example in the form of gold or silver trim. The metal reflects microwaves and this could cause sparking. The microwaves cannot be absorbed.

Microwaves pass through a suitable container and find their way directly into the food. All food contains moisture molecules which, when subjected to microwave energy, start to oscillate at a rate of 2.5 billion times a second. This vibration creates heat. It first starts developing around the outside of the food and then slowly penetrates towards the centre. The more water a food contains, the faster it is reheated or cooked.

As heat is produced directly in the food, this has the following advantages:

- Food can generally be cooked without adding liquid or cooking oil, or with just a little water or oil.
- Cooking, reheating and defrosting in a microwave oven is quicker than using conventional methods.
- Nutrients, such as vitamins and minerals, are generally retained.
- The colour, texture and taste of food are not impaired.

Microwaves stop being produced as soon as the cooking process is interrupted or the appliance door is opened. When the appliance is in operation, the closed, sealed door prevents microwaves escaping from the appliance.

# Modes of operation

---

Food is cooked, reheated or defrosted quickly in a microwave oven.

You can use the microwave oven in the following ways:

- Food can be defrosted, reheated or cooked by entering a power setting and a duration.
- Deep-frozen, ready meals can be defrosted and then reheated or cooked.
- The microwave oven can also be used for other tasks, e.g. for proving yeast dough, melting chocolate and butter, dissolving gelatine, preparing cake glazes and bottling small amounts of fruit and vegetables.

## Functions

### Microwave Solo mode

Suitable for defrosting, reheating and cooking.

### Grilling

Ideal for grilling thin cuts of meat, e.g. steak or sausages.

### Combination mode (Microwave + Grill)

Ideal for browning dishes with toppings. The microwave cooks the food, and the grill browns it.

### Automatic programmes

You can choose from the following automatic programmes:

five defrosting programmes

(☼: Ad 1 to Ad 5),

– four cooking programmes for frozen food

(☼ ☰: Ac 1 to Ac 4 ),

and eight cooking programmes for fresh food

(☰: Ac 1 to Ac 8).

These programmes are weight dependent. You enter the weight of the food and then the cooking duration is calculated automatically.

The weight of the food can be displayed as metric (g) or imperial (lb) (see “Changing settings”).

# Suitable containers for microwave ovens

Microwaves:

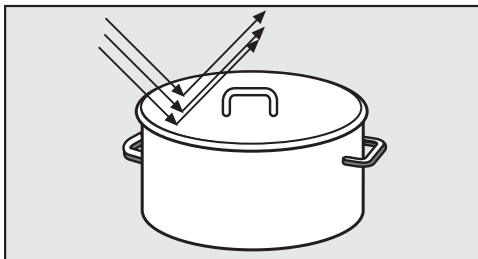

- are reflected by metal.

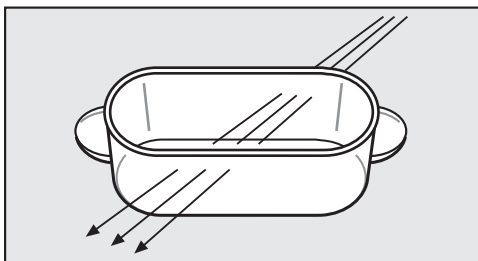

- pass through glass, porcelain, plastic and cardboard.

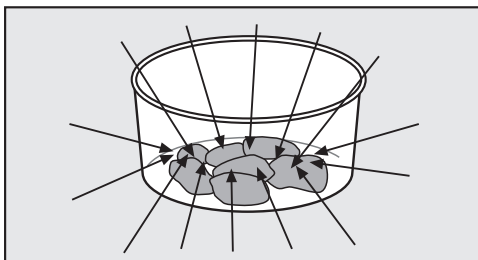

- are absorbed by food.

**⚠** Fire hazard due to unsuitable container.

Containers which are not suitable for use in microwave ovens can be badly damaged and cause damage to the appliance if used.

Please observe the information on suitable containers.

## Material and shape

The material and shape of the container used affect reheating and cooking durations. Round and oval-shaped shallow containers are particularly suitable. Food heats up more evenly in these containers than in square containers.

**⚠** Risk of injury due to hollow handle elements and lid knobs.

When using containers with hollow parts, moisture can get inside and pressure can build up, causing the container to crack or shatter.

Do not use containers with hollow handle elements or lid knobs unless the hollow parts are sufficiently ventilated.

## Metal

Metal containers, aluminium foil, metal cutlery, and crockery with metallic decoration, such as gold rims or cobalt blue, must not be used in the microwave oven. Metal reflects microwaves and obstructs the cooking process.

Do not use containers where the foil lid has not been completely removed.

Exceptions:

- Ready meals in aluminium foil dishes. These can be defrosted and reheated in the microwave oven. Important: Remove the lid and make sure the foil dish is at least 2 cm from the oven walls at all times. However, food is only heated from the top. Transferring the food from the aluminium foil container to a dish suitable for use in a microwave oven will result in more even heat distribution.

# Suitable containers for microwave ovens

Do not place aluminium foil dishes on the rack in case the dish sparks or arcs.

- Pieces of aluminium foil

For even defrosting and to avoid overcooking unevenly shaped cuts of meat, poultry or fish, small pieces of aluminium foil may be used to mask wing-tips or other thin parts for the last few minutes of the programme.

Make sure that the aluminium foil is at least 2 cm from the oven walls at all times. It must not touch the walls.

- Metal meat skewers or clamps

These should only be used if they are very small in comparison to the size of the cut of meat.

## Glazes and colours

Some dishes have glazes and colours containing metallic substances. These dishes are unsuitable for microwave ovens.

## Glass

Heat-resistant glass or ceramic dishes are ideal for use with microwave power.

Crystal glass is unsuitable as it contains lead which could cause the glass to crack in the microwave. It is therefore not suitable.

## Porcelain

Porcelain is a suitable material.

However do not use porcelain with gold or silver edging or items with hollow knobs or handles, as insufficient ventilation may cause pressure.

## Stoneware

Decorated stoneware is only suitable if the decoration is beneath an all-over glaze.

Stoneware can get hot.  
Wear oven gloves.

## Wood

Moisture contained in the wood evaporates during the cooking process. This causes the wood to dry and crack.

Wooden dishes are therefore not suitable.

## Plastics

 Damage due to heat-sensitive plastic.

Plastic containers must be heat-resistant to a minimum of 110 °C. Otherwise the plastic may warp and fuse with the food.

Use only plastic containers suitable for use with Microwave Solo.

Special plastic containers designed for use in microwave ovens are available from specialist retail outlets.

Melamine containers are unsuitable. Melamine absorbs microwave energy and gets hot. When purchasing plastic containers, make sure that they are

# Suitable containers for microwave ovens

suitable for use in a microwave oven. Disposable containers, such as trays made from polystyrene, can only be used to reheat food for a short time.

Plastic boiling bags can be used for cooking and reheating. They should be pierced beforehand. The holes allow the steam to escape. This prevents a build-up of pressure from forming and the bag from bursting.

There are also special bags available for steam cooking which do not need to be pierced. Please follow instructions given on the packet.



Fire hazard due to unsuitable material.

Metal clips and plastic or paper ties containing wire can ignite.

Avoid using these clips and ties.

## Single-use containers

Single-use containers made of plastic must meet the requirements indicated under “Plastics”.



Fire hazard due to unsuitable container.

Single-use containers made of plastic, paper or other inflammable materials can ignite.

Do not leave the appliance unattended when reheating or cooking food in single-use containers made of plastic, paper or other inflammable materials.

To protect the environment, we do not recommend the use of single-use containers.

## Testing containers

If in doubt as to whether glass, earthenware or porcelain plates or dishes are suitable for use in a microwave oven, a simple test can be performed:

- Place the item you wish to test in the centre of the oven.
- Close the door.
- Turn the power selector to 900 W.
- Enter a duration of 30 seconds with the time selector.
- Press the Start button.

If a crackling noise is heard accompanied by sparks during the test, switch the appliance off immediately (touch Stop/C twice)! Any crockery which causes this reaction is unsuitable for use with microwave power. If any doubt exists about the suitability of containers, please contact the supplier.

This test cannot be used to check whether items with hollow knobs or handles are suitable for use with microwave power.

# Suitable containers for microwave ovens

## A heat-retaining cover

- prevents too much steam escaping, especially when cooking foods with longer reheating times.
- speeds up the reheating process.
- prevents food from drying out.
- helps keep the oven compartment clean.

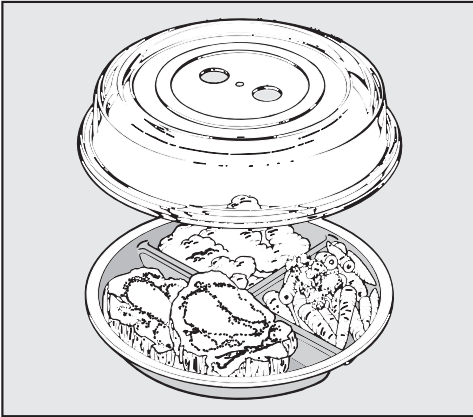

- When using Microwave Solo mode, always cover food with a microwave-safe heat-retaining cover.

Suitable heat-retaining covers are available from retail outlets.

You can use a cling film recommended for use in a microwave oven instead of the heat-retaining cover. Heat can cause normal cling film to distort and fuse with the food.

⚠ Damage due to heat-sensitive plastic.

The material of the cover can generally withstand temperatures of up to 110 °C (see manufacturer information). At higher temperatures the plastic can distort and fuse with the food.

The cover can therefore only be used in microwave ovens and only in Microwave Solo mode without the gourmet plate.

⚠ Damage due to covered openings.

If the cover is used with a container with a small diameter, the cover could form a seal around the container and steam may not be able to escape through the openings in the side of the cover. The cover could get too hot and could start to melt.

Make sure that the cover does not form a seal.

## Do not use a heat-retaining cover if:

- food coated with breadcrumbs is being heated.
- cooking food which needs a crisp finish, e.g. toast.
- the gourmet plate is being used.

⚠ Danger of explosion due to pressure build-up.

Pressure can build up during reheating in sealed containers or bottles, causing them to explode.

Sealed glass containers, such as jars of baby food, must be opened before they are heated in the microwave oven. Do not attempt to heat them up unopened. With baby bottles, the screw top and teat must be taken off.

# Before using for the first time

## Setting the time

- Connect the appliance to the electricity supply.

12:00 and the ⌚ symbol will flash in the display until the current time of day is set. Before this, the time of day will start to run from 12:00, as the clock will start as soon as the appliance is connected to the mains electricity supply.

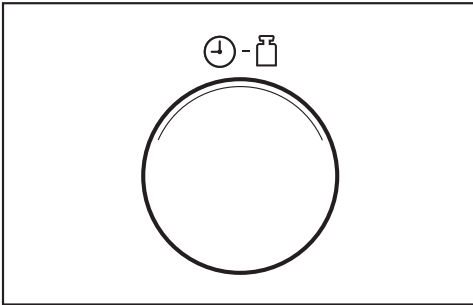

- Turn the time selector to set the hour.
- Press the ⌚ button.
- Then turn the time selector to set the minutes.
- Press the ⌚ button to confirm, or wait a few seconds.

The set time is now adopted. The colon between hours and minutes flashes.

## Altering the time of day

- Press the ⌚ button.

The ⌚ symbol will flash in the display, and the current hour will light up for a few seconds.

- Use the time selector to alter the hour.
- Press the ⌚ button to confirm, or wait for a few seconds.

The ⌚ symbol will flash and the current minutes will light up for a few seconds.

- Use the time selector to alter the minutes.
- Press the ⌚ button to confirm, or wait for a few seconds.

## Switching off the time of day display

- Press and hold in the ⌚ button until the display goes dark.

Pressing and holding in the ⌚ button again will bring back the time of day display.

## Night switch-off

The time of day display can be set to switch itself off from 23:00 to 04:00 hrs.

## Setting the time of day display to switch off at night

- Press and hold in the Stop/C button and at the same time press the ⌚ button.

*ON* will appear in the display. The appliance is ready for operation.

## To switch the display back on

- Press and hold in the Stop/C button and at the same time press the ⌚ button.

*OFF* will appear in the display.

# Operation

## Opening the door

- Press  to open the door.

If the microwave oven is being used, opening the door will interrupt the cooking programme.

## Placing the dish in the oven

Ideally the dish should be placed in the middle of the oven.

## Turntable

The turntable helps the food to cook, reheat or defrost evenly.

Do not operate the microwave without the turntable in place.

The turntable starts turning automatically when the appliance is operated.

Do not cook, reheat or defrost food directly on the turntable. Check that the dish is not larger in size than the turntable.

Turn or stir food during cooking, or turn the dish so that it heats up evenly.

## Closing the door

- Push the door shut.

Press the Start button again to resume an interrupted cooking programme.

The appliance will not start again if the door has not been closed properly.

## Starting a programme

Use the appropriate selector to choose the microwave power level and the cooking duration.

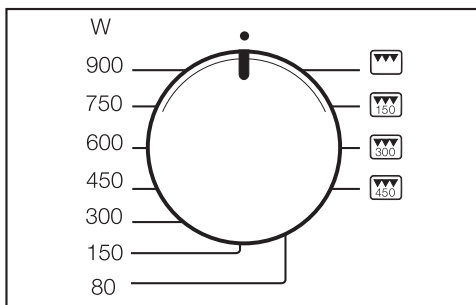

- Use the power selector to select a microwave power level.

 and the microwave power level will light up in the display. 0:00 will flash.

There is a choice of 7 power levels. The higher the power level, the more microwaves reach the food.

When heating up food which cannot be stirred or turned during cooking, as with a plated meal, it is best to use a lower microwave power level.

This ensures the heat is distributed evenly. Heat for long enough to cook the food properly.

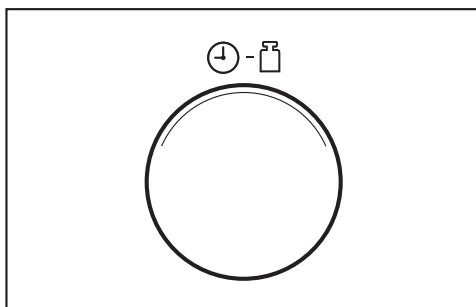

- Set the required duration using the time selector.

The duration selected is visible in the display.

A duration of between 10 seconds and 90 minutes can be set. Exception: If the maximum microwave power level has been selected, a maximum cooking duration of only 15 minutes can be set. If you then continue to select full power, the power level may reduce to 600 W, and this is shown in the display (protection against overheating).

The duration required depends on:

- the initial temperature of the food.  
Food taken straight from the refrigerator takes longer to cook than food which has been kept at room temperature.
  - the type and texture of the food.  
Fresh vegetables contain more water and cook more quickly than stored vegetables.
  - the frequency of stirring or turning the food.  
Frequent stirring or turning heats the food more evenly, and it is therefore ready in a shorter time.
  - the amount of food.  
As a general rule, allow approx. time and a half for double the quantity and for a smaller quantity, possibly shorten the duration.
  - the shape and material of the container.
- Press “Start” to start the programme.

The interior lighting comes on.

A programme can only be started if the door is closed.

## “door” message

The “door” message in the display is a reminder that the appliance should not be used without food inside it.

Operating the appliance without food can damage the appliance.

If the Start button is pressed without the door having first been opened, the word **door** appears in the display. If the door has been closed for 20 minutes or longer when the Start button is pressed, the word door will appear in the display to remind you to open the door and make sure there is food in the oven before you press Start. You cannot start a process until you do this.

## Interrupting or re-starting a programme

At any time you can . . . . .

. . **interrupt a programme:**

- Press the Stop/C button, or open the appliance door.

The duration stops counting down.

. . **continue a programme.**

- Close the door and press Start.

The programme will continue.

# Operation

---

## Altering settings

If you discover after starting a programme that . . . . .

. . . . . the **microwave power level** is too high or too low, you can

- select a new level.

. . . . . the **duration** set is too short or too long, you can

- interrupt the programme (press the Stop/C button once), use the time selector to set a new duration and continue the programme (press the Start button),

or alternatively:

- the cooking duration can be increased by pressing the Start button during operation. Each time the Start button is pressed, the cooking duration is increased by another minute. (Exception: the increased cooking duration is in increments of 30 seconds when the microwave oven is being used on maximum power.)

## Cancelling a programme

- Press the Stop/C button twice.

## At the end of a programme

An audible tone will sound when the cooking programme is complete. The interior lighting goes off.

The audible tone will sound briefly as a reminder every 5 minutes for 20 minutes after the end of the programme.

- If you want to stop the audible tone, press the Stop/C button.

## Automatic keeping-warm function

The keeping warm function will switch on automatically after the end of a cooking programme which has used at least 450 W, providing the door remains closed and no buttons are pressed. After approx. 2 minutes the keeping warm function will switch on at 80 W for a maximum period of 15 minutes.

, 80 W and **H:H** will light up in the display.

Opening the door or operating one of the buttons or selectors while the keeping warm function is in progress cancels the function.



The keeping warm function cannot be set separately.

You can deactivate this function (see “Changing settings”).

## Quick start (programmable)

Pressing the Start /  button is sufficient to set the appliance operating on maximum power.

Three set times are stored in the memory:



- 30 s: press Start /  1 x
- 1 min: press Start /  2 x
- 2 min: press Start /  3 x

Pressing Start /  four times in succession will bring back the first stored duration and so on.

The cooking duration can be increased by pressing “Start” during operation; each time “Start” is pressed, the cooking duration is increased by another 30 seconds.

## Programming durations

Set durations can be altered.

- Use the Start /  button to select the duration you want to re-programme (press once, twice or three times) and hold the Start /  button pressed in.
- Alter the duration with the time selector (to max 15 minutes).

The altered programme runs when you take your finger off the Start /  button.

An interruption to the power supply will cancel any altered programmed durations, and they will need to be entered again.

## System lock

The system lock prevents the appliance being used by children, for example.

### Activating the system lock

- Press and hold the Stop/C button in until an audible tone sounds and the key symbol appears in the display:



The key symbol will go out after a short time.

The key symbol reappears whenever any button or one of the rotary selectors is operated.

After an interruption to the power supply, the system lock will need to be reactivated.

### Deactivating the system lock

- To cancel the system lock, press the Stop/C button again and hold it pressed in until an audible tone sounds.

# Operation

---

## Using the minute minder



The minute minder can be used to time any activity in the kitchen, e.g. boiling eggs. The time set counts down in one second steps.

- Press the  button.

0:00 flashes and the  symbol lights up in the display.

- Use the time selector to set the minute minder time you require.
- Press “Start” to start the programme.

The minute minder time will start itself after a few seconds if the Start button is not pressed.

- At the end of the minute minder time, an audible tone sounds. The time of day reappears and the  symbol flashes.
- Press the Stop/C button once and the  symbol disappears.

## Altering a minute minder entry

- Press the Stop/C button.

The current minute minder time is stopped.

- Set a new minute minder time, as described above.

## Minute minder + cooking function

The minute minder can be used at the same time as a cooking function, and counts down in the background.

- Press the  button during the cooking programme.

0:00 flashes and the  symbol lights up in the display.

- Use the time selector to set the minute minder time you require.
- Wait a few seconds and the minute minder set will begin to count down.

A few seconds later, the display will change again to show the cooking duration counting down. The minute minder time counting down in the background is represented by the illuminated  symbol.

Do not press the Start button in this instance to start the minute minder, as pressing the Start button would also increase the cooking duration by a minute.

## To find out the minute minder time remaining

- Press the  button.

The minute minder time still remaining will show in the display.

## Operation – grilling

The grill has 4 settings: grill solo and 3 combination settings where the grill is used together with a specific microwave power level.

If the total grilling duration required is less than 15 minutes, the grill should be pre-heated for approx. 5 minutes.

Thin, flat cuts of fish and meat should be turned half way through grilling for even results. Larger, chunkier pieces should be turned several times.

Grilling durations depend on the type and thickness of the food and on the user's preference for a rare or well-cooked result.

When grilling directly on the rack, a heat-resistant, microwave-safe container should be placed underneath the rack to catch any fat or juices.

 Risk of damage due to overheating.

The gourmet plate supplied is not suitable for catching fat. It could overheat when empty. This would damage the coating.

Use a heat-resistant, microwave-safe dish instead.

- Place the food in a suitable dish.
- Place the rack and a heat-resistant, microwave-safe dish or the container with the food to be cooked on the turntable.

 Risk of burning due to hot dishes.

The rack and container become hot during use.

Wear oven gloves.

The container (and glass tray) and grill rack will be easier to clean if washed in soapy water immediately after grilling.

The area on the ceiling around the grill becomes discoloured over time. This is an unavoidable consequence of use, and does not impair the function of the appliance in any way.

### Grilling without the Microwave function

Ideal for grilling thin cuts of meat, e.g. steak or sausages.

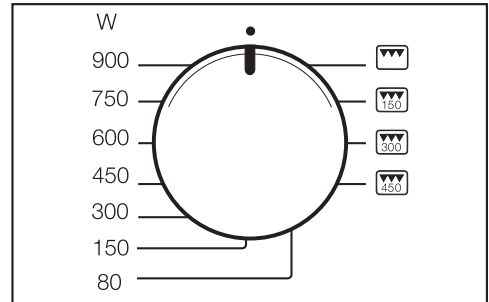

- Turn the power selector to .

0:00 flashes and the  symbol lights up in the display.

- Select a cooking duration using the time selector.
- Press the Start button.

An audible tone will sound when the cooking programme is complete.

# Operation – grilling

## To change a cooking duration



The cooking duration entered can be changed during operation if required. Interrupt the process by pressing the Stop/C button, and change the duration. To continue, press the Start button. The cooking duration can also be extended during operation by pressing the Start button once for each minute you wish to extend the cooking duration by.

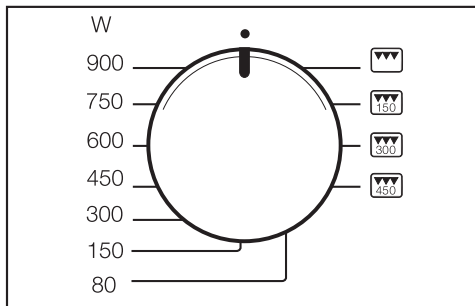

## Combination mode - Microwave + Grill

This function is very good for baking and browning. The microwave cooks the food, and the grill browns it.

The grill can be combined with one of three different microwave power levels: 150, 300 and 450 W. It is possible during the cooking process to switch between the different power levels without interrupting the programme.



- Use the power selector to select   or  as you require.

The  symbol, the microwave power level and the  grill symbol will light up in the display. 0:00 will flash.

- Select a cooking duration using the time selector.

- Press the Start button.

An audible tone will sound when the cooking programme is complete.

## To change a cooking duration

The cooking duration entered can be changed during operation if required. Interrupt the process by pressing the Stop/C button, and change the duration. To continue, press the Start button. The cooking duration can also be extended during operation by pressing the Start button once for each minute you wish to extend the cooking duration by.

## Tips for use

 Risk of burning due to hot dishes.

The gourmet plate gets extremely hot when in use.

Always use oven gloves when handling it to avoid burns. Place it on a suitable heat-resistant mat or stand.

## Before using for the first time

Before using the gourmet plate for the first time, fill it with 400 ml water and add 3 to 4 tbsp vinegar or lemon juice. Heat for 5 minutes at 450 W + Grill .

The gourmet plate has an easy-to-clean anti-stick coating so that food can be removed easily.

The coating is susceptible to cuts and scratches.

Metallic or sharp objects can damage the non-stick coating.

Therefore do not cut food up directly on the plate.

Use wooden or plastic utensils to mix or turn food.

## Searing/browning food

 Fire hazard due to overheating.

Oils and fats can ignite if allowed to overheat.

Never leave the gourmet plate unattended when cooking with oil or fats.

- Only very little fat or oil is necessary when cooking with this dish. This is because food does not stick to the non-stick coating. This has the added advantage of keeping down the calorie count.

- When using the gourmet plate, make sure that the food is ready to transfer to the gourmet plate as soon as it has heated up.

- Place the gourmet plate directly on the turntable.

Sparkling can damage the gourmet plate and the oven compartment.

Do not place the gourmet plate on the rack. Make sure there is a gap of approx. 2 cm between the gourmet plate and the interior walls of the microwave oven so that sparking cannot occur.

- Heat the plate at 450 W + Grill  for max. 5 minutes.

 Risk of damage due to overheating.

Do not overheat the empty gourmet plate. This would damage the coating.

For this reason, do not place the gourmet plate under the rack to catch the fat when grilling.

If using oil, you can either heat up the oil on the gourmet plate, or you can heat the oil separately and then add it to the plate.

Butter, however, should always be added after heating up the gourmet plate. It has a lower burning point than oil and would get too dark or burn if added too soon.

Always dry meat, poultry, fish and vegetables thoroughly before placing them on the gourmet plate.







# Gourmet plate

Eggs can explode.

Do not use the gourmet plate to cook eggs or reheat cooked eggs.

## Examples of use:

Pre-heat the gourmet plate directly on the turntable for up to max. 5 minutes at 450 W + Grill .

- Fish fingers (frozen), 150 g + 2 tbsp oil , 3 – 4 minutes each side
- Hamburgers, 2 burgers + 2 tbsp oil , 3 – 4 minutes each side
- Croquette potatoes (frozen), 10 – 12 pieces + 2 tbsp oil , 6 – 8 minutes, turning halfway through
- Fillet steak, approx. 200 g , 5 minutes each side (according to taste)
- Pizza (frozen), 300 g, , 7 – 9 minutes
- Pizza (fresh), without pre-heating , 15 minutes approx. (depending on topping)

## Recipes

The total time required includes the time required for preparation and cooking. Standing time or time for marinating food is quoted in addition to the total time required.

## Croque monsieur (serves 3)

Total time required: 10 – 15 minutes

### Ingredients

6 slices of white bread  
30 g soft butter  
75 g Emmental cheese, grated  
3 slices of ham

### Method

Butter the bread. Add the cheese to three of the bread slices in equal amounts and arrange a slice of ham on top of each. Place the remaining three slices of bread on top of the ham with the buttered side face down. Pre-heat the gourmet plate using 450 W + Grill for approx. 5 minutes, then place the bread on it. Place on the turntable and cook using 450 W + Grill for approx. 3 minutes each side until golden. Other fillings could include drained tuna fish with finely sliced onion rings, or pineapple, cheese and ham.

## Vegetable medley (serves 3)

Total time required: 25 – 35 minutes

### Ingredients

2 onions  
2 tbsp oil  
100 g oyster mushrooms or button mushrooms, cleaned  
150 g sliced carrots  
100 g broccoli florets  
1 red pepper or 100 g frozen sliced peppers  
1 tomato  
Salt and pepper  
30 g grated Parmesan cheese

### Method

Slice the onions into fine rings. Halve, quarter and deseed the pepper, and then cut into strips. Dice the tomato. Place the gourmet plate on the turntable and pre-heat it using 450 W + Grill for approx. 5 minutes. Add oil and onion rings. Place gourmet plate back on the turntable and cook using 450 W + Grill for approx. 2 minutes. Add the mushrooms, carrots, broccoli, sliced pepper, diced tomato and seasoning. Mix well. Cook using 450 Watt + Grill for approx. 6 minutes. Turn out and sprinkle with Parmesan cheese before serving.

## Pork fillets (serves 2)

Total time required: 15 – 20 minutes

### Ingredients

1 pork tenderloin (approx. 400 g)  
4 rashers of streaky bacon  
Salt and pepper  
10 g butter  
200 g sliced button mushrooms  
200 ml double cream  
2 tbsp brandy

### Method

Cut the pork tenderloin into four pieces. Season each piece with salt and pepper, and wrap in a rasher of streaky bacon. Secure with a cocktail stick if necessary. Place the gourmet plate on the turntable and pre-heat it using 450 W + Grill for approx. 5 minutes. Add the butter to the plate, and place the meat on top. Place on the turntable and cook using 450 W + Grill for approx. 3 minutes each side. Transfer the meat to a serving dish, cover and keep warm. Add the mushrooms, cream and brandy to the meat juices and heat on maximum power for approx. 4 minutes. Serve with the meat.

## Pork fillet in a Roquefort sauce

Total time required: 10 – 12 minutes

### Method

Cut 1 pork tenderloin into four pieces. Place on the pre-heated gourmet plate and cook using 450 W + Grill for approx. 4 minutes. Add 50 ml white wine, 125 ml double cream, 2 tbsp roux (made from 1 tbsp each of flour and melted butter) and 150 g Roquefort cheese. Stir the sauce until smooth, and cook for a further 3 minutes.

# Gourmet plate

---

## Curried chicken (serves 3)

Total time required: 25 – 35 minutes

### Ingredients

600 g chicken or turkey breast fillets  
2 tbsp oil  
2 tbsp white wine  
2 tbsp apple juice  
1 tbsp lemon juice  
Salt and freshly ground black pepper  
1 tsp curry powder  
1 pinch rosemary, ground  
1 pinch ginger, ground  
1 pinch cayenne pepper  
 $\frac{1}{2}$  tsp Tabasco  
20 g butter

### Method

Dice the meat into 2 x 2 cm pieces. Combine the rest of the ingredients apart from the butter, and pour over the meat. Mix well, and leave to stand for approx. 30 minutes. Place the gourmet plate on the turntable, Pre-heat it using 450 Watt + Grill for approx. 5 minutes. Add the butter to the pre-heated plate, then add the slightly drained meat. Place the gourmet plate on the turntable and cook using 450 W + Grill for approx. 4 minutes, turn and cook for a further 4 minutes on the same setting. Drain surplus liquid from the meat if necessary so that it browns well.

## Fisherman's salmon (serves 2)

Total time required: 5 – 10 minutes

### Ingredients

2 salmon fillets (approx. 150 g each)  
1 tbsp lemon juice  
Salt, white pepper

### Method

Drizzle the salmon with the lemon juice, and leave to stand for approx. 10 minutes. Place the gourmet plate on the turntable and pre-heat using 450 W + Grill for approx. 5 minutes. Pat the fish dry with kitchen paper, and place on the gourmet plate, pressing it down slightly. Place on the turntable and cook using 450 W + Grill for approx.  $1\frac{1}{2}$  – 2 minutes each side. Serve with rice, hollandaise sauce or melted butter and a fresh green salad.

# Operation - Automatic programmes

All of the automatic programmes are weight dependent.

The weight of the food can be displayed as metric (g) or imperial (lb) (see “Changing settings”).

After selecting a programme, enter the weight of the food. The appliance automatically calculates the duration according to the weight entered.

After cooking, allow the food to stand at room temperature for the suggested number of minutes (“standing time”) to allow the heat to be distributed evenly through the food.

## Automatic defrosting

There are five programmes for defrosting different types of food (❄️ button). The standing time for programme Ad 3 is up to 30 minutes, depending on weight, and approx. 10 minutes for the remaining programmes.

Ad 1 🍖 Steak, chops  
200–1.000 g

Ad 2 🍖 Minced meat  
200–1.000 g

Ad 3 🍗 Chicken  
900–1.800 g

Ad 4 🍰 Cakes  
100–1.400 g

Ad 5 🍞 Bread  
100–1.000 g

This programme is particularly suitable for defrosting frozen sliced bread. If possible, place single slices in the appliance, or separate the slices when the buzzer sounds.

## Automatic cooking

There are four programmes for frozen food and eight programmes for fresh food.

The standing time for each of these programmes is approx. 2 minutes.

⚠️ Damage due to heat-sensitive plastic.

The material of a heat-retaining cover can generally withstand temperatures of up to 110 °C (see manufacturer information). At higher temperatures the plastic can distort and fuse with the food.

A heat-retaining cover must only be used with Microwave Solo mode. On no account must the cover be used if the grill is switched on, i.e. with programmes AC 4 to AC 8.

## Cooking food from frozen ❄️ 🍷

AC 1 🍷 Vegetables  
100–600 g

AC 2 🍷 Ready meals which can be stirred  
300–1.000 g

AC 3 🍷 Bakes / gratin  
200–600 g

AC 4 🍷 French fries  
200–400 g

## Operation - Automatic programmes

### Cooking fresh food

AC 1  Vegetables  
100–600 g

AC 2  Potatoes  
100–800 g

AC 3  Fish  
500–1.500 g

AC 4  Kebabs  
200–800 g



AC 5  Whole chicken  
900–1.800 g

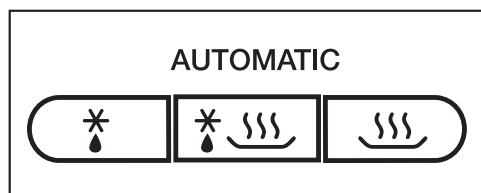

AC 6  Chicken drumsticks  
250–1.000 g

AC 7  Fish pie  
500–1.500 g



AC 8  Gratins/bakes,  
z. B.: Potato gratin  
500–1.500 g



- Press the relevant button repeatedly until the Automatic programme required shows in the display. For example, to call up programme AC 5  (Grilled chicken) press the  button five times.

g or lb will flash in the display to prompt you to enter the weight and the programme (e.g. AC 5) will light up together with the symbols for the functions being used ( for Microwave and  for Grill).

- Use the rotary selector to enter the weight.
- Press the Start button.

The duration (which depends on the weight) will begin to count down, and the symbols for the functions that are currently in use will light up ( and/or ).

An audible tone will sound halfway through the cooking duration.

- Interrupt the programme to turn or stir the food, and then continue the programme.

The programmed duration can, if necessary, be extended by a few minutes during operation by touching Start repeatedly until the time required shows in the display. In all programmes it is only possible to extend the time by a few minutes.

An audible tone will sound when the cooking programme is complete. The interior lighting goes off.

# Recipes for automatic programmes

Below are some recipe suggestions for the Automatic programmes using the “Cooking fresh food ” function . These can be adapted to suit your requirements.

If the weight guidelines are exceeded, the food will not cook sufficiently.

It is important to follow the weight guidelines for the programme concerned.

## AC 1 Vegetables

### Method

Place the washed and prepared vegetables in a container. Add 3–4 tbsp water, depending on freshness and moisture content, and a little salt or other seasoning. Enter the weight including the water, place the covered cooking container on the turntable and cook. About halfway through the cooking duration, a buzzer will sound to prompt you to turn or stir the food.

When cooking vegetables in a sauce, the weight entered must include the sauce. Do not exceed the maximum weight guidelines.

## Carrots in a chervil cream sauce (serves 2)

Total time required: 25 – 35 minutes

### Ingredients

350 g carrots, cleaned  
5 g butter  
50 ml vegetable stock (instant)  
75 ml crème fraîche  
1 tbsp white wine  
Salt and pepper  
1 pinch of sugar  
 $\frac{1}{2}$  tsp mustard  
1-2 tbsp chervil, fresh, chopped or  
1 tbsp chervil, dried and ground  
Approx. 1 tbsp cornflour

### Method

Peel carrots, then cut into batons or slice (approx. 3 – 4 mm thick). Combine the rest of the ingredients, and pour over the carrots. Cover and cook. Stir when the audible tone sounds.

Setting: Cooking fresh food AC 1   
Weight: 525 g  
Shelf level: Turntable

## Recipes for automatic programmes

---

### AC 2 Potatoes

This programme can be used to cook peeled, new and bouillon potatoes.

#### Method

Enter the weight for the potatoes and the cooking liquid.

For peeled potatoes, peel, wash and drain the potatoes and place them in a cooking container. Season with a little salt, cover and cook.

When cooking potatoes, add approx. 1 tbsp water per potato. If cooking the potatoes in their skins, pierce the skins several times with a fork or skewer before cooking, then cover the container and cook.

### Golden curried potatoes (serves 3)

Total time required: 25 – 35 minutes

#### Ingredients

500 g peeled potatoes  
1 onion, finely diced  
10 g butter  
1 – 2 tbsp curry powder  
250 ml vegetable stock (instant)  
50 ml double cream  
125 g peas (frozen)  
Salt and pepper

#### Method

Coarsely dice the potatoes (approx. 3 x 3 cm) or use small potatoes. Mix together all the ingredients in a suitably large dish. Cover and cook. Stir when the audible tone sounds then continue cooking.

Setting: Cooking fresh food AC 2 

Weight: 800 g

Shelf level: Turntable

# Recipes for automatic programmes

## AC 8 Gratins/Bakes: Vegetable gratin (serves 4)

Total time required: approx. 40 minutes

### Ingredients

400 g cauliflower or broccoli  
400 g carrots

### For the cheese sauce

20 g margarine  
20 g flour  
300 ml vegetable stock (instant)  
200 ml milk  
100 g diced Emmental cheese  
50 g grated Gouda cheese  
Pepper, salt, ground nutmeg  
1 tbsp chopped parsley

### Method

Cut the cauliflower or broccoli into small florets, and thinly slice the carrots (approx. 3 mm thick). Place the vegetables in a baking dish (approx. 24 cm in diameter), and mix well. Melt the margarine in a pan on the hob, stir in the flour and then add the stock and milk whilst continuing to stir. Stir in the Emmental cheese, and simmer until the cheese has melted. Season well with nutmeg, salt and pepper and add the parsley. Pour the sauce over the vegetables, and sprinkle over the grated Gouda cheese. Bake in the oven uncovered.

Setting: Cooking fresh food AC 8   
Weight: 1500 g  
Shelf level: Turntable

## Potato cheese gratin (serves 4)

Total time required: 45 minutes

### Ingredients

For the gratin  
600 g potatoes, floury  
75 g Gouda, grated

### For the topping

250 ml double cream  
1 tsp salt  
Pepper  
Nutmeg

### For sprinkling

75 g Gouda, grated

### For the dish

1 clove of garlic

### Accessories

Microwave-safe ovenproof dish,  
Ø 26 cm

### Method

Rub the ovenproof dish with the garlic clove.

To make the cream topping, mix together the cream, salt, pepper and nutmeg.

Peel the potatoes and cut them into slices 3–4 mm thick. Mix the potatoes with the cheese and the cream topping, and transfer to the ovenproof dish.

Sprinkle with gouda, then bake uncovered.

Setting: Cooking fresh food AC 8   
Weight: 1000 g  
Shelf level: Turntable

## Recipes for automatic programmes

---

### AC 4 Pork kebabs (makes 8 kebabs)

Total time required: approx. 25 – 35 minutes + 1 hour standing time

#### Ingredients

1 fillet of pork (approx. 300 g)  
1 red pepper  
2 onions

#### For the marinade

8 tbsp oil  
Salt, pepper, paprika and chilli powder  
8 wooden skewers

#### Method

Cut the pork fillet into 16 cubes. Wash the pepper and cut into bite-sized pieces. Cut the onions into eight pieces. Place the meat, pepper and onion pieces alternately on the skewers. Mix together the ingredients for the marinade and brush the kebabs with the mixture. Allow to marinate for approx. an hour. Lay the kebabs on a lightly oiled grill rack, brush with butter and place in the oven together with a heat-resistant, microwave safe dish. Turn halfway through grilling when the audible tone sounds.

Setting: Cooking fresh food AC 4   
Weight: approx. 100 g per kebab  
Shelf level: Rack and dish on turntable

### Chicken kebabs (makes 8 kebabs)

Total time required: approx. 25 – 35 minutes + 1 hour standing time

#### Ingredients

4 chicken breasts each approx. 120 g  
4 tinned pineapple rings  
16 tinned apricot halves

#### For the marinade

4 tbsp oil  
4 tbsp sesame oil  
Salt and pepper  
 $\frac{1}{2}$  tsp paprika  
 $\frac{1}{2}$  tsp curry powder  
A little chilli powder  
Ground ginger or coriander, if desired

8 wooden skewers

#### Method

Cut each chicken breast into 4 pieces. Cut the pineapple slices into quarters. Drain the tinned apricot halves well. Mix all ingredients for the marinade thoroughly.

Arrange the chicken pieces, pineapple and apricots alternately on the wooden skewers, brush with the marinade and set aside for 1 hour. Put the kebabs on the grilling rack and place in the oven together with a heat-resistant, microwave safe dish. Turn halfway through grilling when the audible tone sounds.

Setting: Cooking fresh food AC 4   
Weight: approx. 100 g per kebab  
Shelf level: Rack and dish on turntable

## AC 6 Chicken thighs

### Method

Brush the chicken thighs with butter or oil and season. Place on the grill rack in the oven together with a heat-resistant, microwave-safe dish. Halfway through cooking when a buzzer sounds, turn the chicken thighs over and continue to cook.

## AC 5 Whole chicken

### Method

Cut the chicken in half. Brush with melted butter or oil, and season. Then place the chicken halves on the grill rack in the oven with the cut side facing upwards together with a heat-resistant, microwave safe dish. Halfway through cooking when an audible tone sounds, turn the chicken halves over and continue to cook.

## Re. AC 6 and AC 5

### Method

For a good colour and flavour when grilling chicken, sprinkle with a mixture of paprika and curry powder. The spices will give the skin an appetising golden colour as well as enhancing the flavour.

## AC 3 Fish: Fish curry (serves 4)

Total time required: 35 – 45 minutes

### Ingredients

300 g pineapple chunks  
1 red pepper  
1 small banana  
500 g firm white fish  
3 tbsp lemon juice  
30 g butter  
100 ml white wine  
100 ml pineapple juice  
Salt, sugar and chilli powder  
2 tbsp cornflour

### Method

Dice the fish and place in a suitable container. Drizzle with lemon juice. Quarter the peppers, remove the seeds and pith, and cut into narrow strips. Peel and slice the banana. Add to the fish together with the pepper and pineapple pieces and mix well. Add the butter. Mix together the wine, juice, seasoning and cornflour to make a smooth sauce and pour over the fish. Mix everything thoroughly, then cover and cook.

Setting: Cooking fresh food AC 3 

Weight: approx. 1200 g

Shelf level: Turntable

## Recipes for automatic programmes

---

### AC 7 Fish bake: Crispy fish pie (serves 2)

Total time required: 25 – 35 minutes

#### Ingredients

400 g filleted white fish, e.g. cod  
3 tbsp lemon juice  
Salt, white pepper  
50 g butter  
2 tsp mustard  
1 onion, finely diced  
40 g grated Gouda cheese  
20 g breadcrumbs  
2 tbsp fresh dill, chopped

#### Method

Drizzle the fish filet with the lemon juice, and leave to stand for approx. 10 minutes. Grease a flat oven dish with a little butter. Pat the fish dry, season with salt and pepper and place in the dish. Mix the melted butter (450 W, 40 – 50 sec.) with the mustard, onions, Gouda cheese, breadcrumbs and dill and brush onto the fish. Bake until golden.

Setting: Cooking fresh food AC 7 

Weight: approx. 600 g

Shelf level: Turntable

### Rosefish and tomato gratin (serves 4)

Total time required: 35 – 45 minutes

#### Ingredients

500 g filleted rosefish or other white fish, e.g. cod  
2 tbsp lemon juice  
500 g tomatoes  
Herbs, seasoning salt  
2 tsp ground oregano  
150 g grated Gouda cheese

#### Method

Cut the fish into pieces, drizzle with lemon juice and leave to stand for approx. 10 minutes. Dice the tomatoes, and place in a baking dish with the fish and half of the cheese. Season generously with herb salt and oregano, and mix well. Sprinkle with the rest of the cheese and bake uncovered.

Setting: Cooking fresh food AC 7 

Weight: approx. 1150 g

Shelf level: Turntable

# Saving your favourite programme (Memory)

You have the option of saving one favourite programme to memory. This programme can be used for your most frequently cooked recipe. The programme can have up to 3 stages (e.g.: 1 minute at 600 W, followed by 2 minutes grill and finally 3 minutes at 150 W with grill).

## Programming

(The example given is for a three-stage programme)

- First select the function for the first stage.
- Then select the duration.

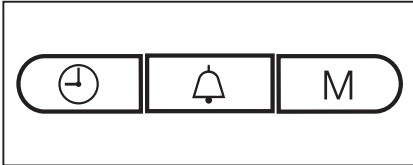

- Press the M button. 1 will light up in the display, and 2 will flash.
- Then select the second function and duration.
- Press the M button again. 2 will light up and 3 will flash.
- Now select the third function and duration and then touch OK. Press the M button.

After this third step, you can use the M button to scroll through your entry and check it.

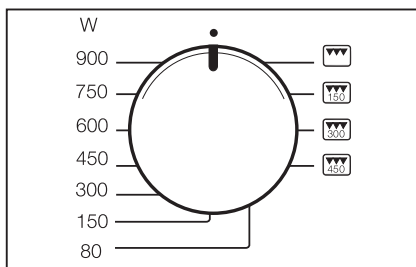

- When you have finished programming, turn the power selector to the 12 o'clock position.
- Start the programme to save the entry. Only ever run the entire programme with food in the appliance.

 Damage due to operation without food.

The microwave oven can be damaged if it is used without food being placed in it.

If there is no food in the appliance, press the Stop/C button twice as soon as you have started the programme.

1- and 2-stage programmes can be saved in the same way. The programming process is finished when the power selector is in the 12 o'clock position and the Start button has been pressed, while pressing the M button shows the next stage.

## To change an entry

- Entering a new programme overrides the previously saved programme.

## To access your favourite programme

- Turn the programme selector to the 12 o'clock position.
- Press the M button.
- Press the Start button.

In the event of a power cut, the favourite programme is no longer saved and must be re-entered.

## Changing settings

Some of the standard settings for the appliance have an alternative.

Please consult the chart for the different options for appliance settings.

The factory settings are marked with a star\* on the chart.

To change a setting, proceed as follows:

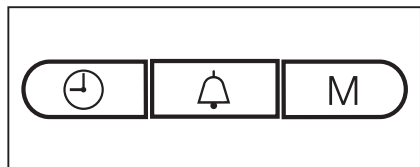

- Press and hold the ⌚ and M buttons at the same time until *P 1* and *≡* light up in the display. Then release them. If you press them for too long, the time of day will appear again in the display.

- Use the rotary selector to select the setting you wish to change (*P 1* to *P 5* and *P 0*). Turn it until the setting required shows in the display.

- Then press the M button to call up the setting.

*S* will appear in the display to show that the setting can be changed.

- Turn the time selector if you wish to change the setting (see chart) and confirm your entry by pressing the M button (for *P 5* and *P 0*, press and hold the M button for approx. 4 seconds).

The change to the setting is then stored in memory. *P* will appear in the display again together with the number for the setting.

The other settings can be changed in the same way.

- When you have finished making the changes you require, press the Stop/C button.

The altered settings are retained after a power cut.

## Changing settings

Setting		Settings available (* factory default)	
P 1	Night time switch-off	S 0*	Night time switch-off is deactivated.
		S 1	Night time switch-off is activated. The time of day display is switched off between the hours of 23:00 and 04:00.
P 2	Automatic keeping-warm function	S 1*	The automatic keeping warm function is activated.
		S 0	The automatic keeping warm function is deactivated.
P 3	“door” message	S 1*	The “door” message appears if the door has not been opened for about 20 minutes. Start is then blocked.
		S 0	The “door” message does not appear.
P 4	Reminder tone	S 1*	The reminder tone sounds briefly every 5 minutes in the first 20 minutes after the end of the programme.
		S 0	Reminder tone is deactivated.
P 5	Demo mode (for showroom use only)	S 0*	Demo mode is deactivated. When demo mode is deactivated, _ _ _ _ appears briefly in the display.
		S 1	Demo mode is activated. When a button or selector is operated, <i>NE5_</i> shows briefly in the display. The appliance cannot be operated.
P 6	Unit of weight	S 0*	Food weight is displayed in grammes (g).
		S 1	Food weight is displayed in pounds (lb).
P 0	Factory default settings	S 1*	Factory default settings have been re-stored, or have not been changed.
		S 0	Factory default settings have been changed.

# Reheat

Select the following microwave power levels to reheat food:

Drinks	900 W
Food	600 W
Food for babies and children	450 W

 Risk of burning due to hot food. Food for babies and children must not be too hot. Only heat it for 1/2 to 1 minute at 450 watts.

## Tips on reheating

Always use a lid or cover when reheating food, except when a crispier finish is needed, e.g. food with a breadcrumb coating.

 Danger of explosion due to pressure build-up. Pressure can build up during reheating in sealed containers or bottles, causing them to explode. Sealed glass containers, such as jars of baby food, must be opened before they are heated in the microwave oven. Do not attempt to heat them up unopened. With baby bottles, the screw top and teat must be taken off.

 Risk of injury caused by over-boiling.

When heating liquids using microwave power, the boiling point of the liquid may be reached without the production of typical bubbles. The liquid does not boil evenly throughout. This so-called boiling delay can cause a sudden build-up of bubbles when the container is removed from the microwave or shaken, which can lead to the liquid boiling over suddenly and explosively. The formation of bubbles can be so strong that the pressure forces the appliance door open.

A boiling delay can be avoided by stirring liquids before reheating them. After reheating, wait at least 20 seconds before removing the container from the oven compartment. In addition, a glass rod or similar item, if available, can be placed in the container during heating.

Eggs can explode.

Never reheat hard boiled eggs using the microwave oven, even without the shell.

Food taken straight from the refrigerator takes longer to cook than food which is at room temperature. The time required depends on the nature of the food, its initial temperature and the amount to be cooked.

Always ensure that food is sufficiently cooked or reheated.

If in any doubt that a sufficiently high temperature has been reached, continue reheating for a little longer.

Stir or turn larger amounts of food from time to time during reheating. Stir the food from the outside towards the middle, as food heats more quickly from the outside.

## After reheating

Be careful when taking out a container. It may be hot.

Although the container is not normally heated by the microwaves (apart from stoneware), heat may transfer from the food to the container.

Allow food to stand for a few minutes at room temperature at the end of a reheating process. This enables the heat to spread evenly throughout the food.

 Risk of burning due to hot food. The food can be very hot after reheating.

After reheating food, especially food for babies and small children, stir the food or shake the container and check that the temperature does not pose any danger.

# Cooking

Place the food in a microwave safe container and cover it.

When cooking, it is a good idea to select a power level of 900 W to start with and then when the food is hot reduce the power level to 450 W for more gentle continued cooking.

For dishes such as **rice** or **semolina pudding**, first select a power level of 900 W, and then reduce it to 150 W for simmering.

## Tips on cooking

Vegetable cooking durations depend on the texture of the vegetable. Fresh vegetables contain more water than vegetables which have been stored, and usually cook more quickly. Add a little water to vegetables which have been stored.

Food taken straight from the refrigerator takes longer to cook than food at room temperature.

Stir or turn food from time to time during cooking. This helps it cook more evenly.

 Health risk due to insufficient cooking duration.

It is very important to make sure that food which goes off easily, such as fish, is cooked for a sufficient time.

Ensure that this type of food is cooked for an appropriate length of time.

**Food with a thick skin or peel**, such as tomatoes, sausages, jacket potatoes and aubergines, should be pierced or the skin scored in several places before cooking to allow steam to escape and to prevent the food from bursting.

 Risk of injury due to eggs with shells.

Eggs heated in their shells can burst, even after they have been taken out of the oven compartment.

Eggs can only be cooked in their shells in the microwave oven in a specially designed egg-boiling device.

 Risk of burning due to eggs without shells.

If you cook eggs without their shells using microwave power, the yolks could explode due to the resulting pressure.

Eggs can only be cooked without their shells in the microwave oven if the yolk membrane has been punctured several times first.

## After cooking

Be careful when removing a dish from the oven. It may be hot.

Although heat is not normally produced in the container itself by the microwaves (apart from stoneware), heat transfer from the food to the container may be considerable, making the container itself hot.

Allow food to stand for a few minutes at room temperature at the end of cooking. This enables the heat to spread evenly throughout the food.

 Health risk due to refreezing. Thawed or defrosted food loses nutritional value through refreezing and can go off. Do not refreeze food once it has thawed. Use it as quickly as possible. Defrosted food may only be refrozen after it has been cooked.

Select the following microwave power levels for defrosting food:

- 80 W  
for defrosting very delicate food, e.g. cream, butter, gateau and cheese.
- 150 W  
for defrosting everything else.

Remove the food from its packaging and place in a microwave-proof container. Defrost uncovered. Turn, stir or separate the food about halfway through the defrosting time.

To defrost meat, unpack the frozen meat and place it on an upturned plate in a glass or porcelain container so that the meat juice can run off and be collected. Turn halfway through defrosting.

 Health risk due to risk of salmonella. It is particularly important to observe food hygiene rules when defrosting poultry. Do not use the liquid produced during defrosting.

Meat, poultry and fish does not need to be fully defrosted before cooking. Defrost until the food has started to thaw. The surface will then be sufficiently thawed to absorb herbs and seasoning.

## Defrosting and cooking

Deep-frozen food can be defrosted and immediately reheated or cooked.

First select 900 W followed by 450 W.

Remove the food from its packaging and place in a covered microwave-proof dish for defrosting and reheating or cooking. Exception: Minced meat should be left uncovered while cooking.

Food with a high water content such as soup, stew and vegetables should be stirred several times during the process. Carefully separate and turn slices of meat halfway through the programme. Turn pieces of fish at the halfway stage.

After defrosting and reheating or cooking allow the food to stand at room temperature for a few minutes to enable the heat to spread evenly throughout the food.

## Examples of use

Food	Quantity	MW power level (W)	Duration (in minutes)	Notes
Melting butter/margarine	100 g	450	1:00 – 1:10	Do not cover
Melting chocolate	100 g	450	3:00 – 3:30	Do not cover, stir halfway through melting
Dissolving gelatine	1 packet + 5 tbsp water	450	0:10 – 0:30	Do not cover, stir halfway through dissolving
Preparing flan topping/jelly glaze	1 packet + 250 ml liquid	450	4 – 5	Do not cover, stir halfway through heating
Yeast dough	Starter dough made with 100 g flour	80	3 – 5	Cover and leave to prove
Making popcorn	1 tbsp (20 g) popcorn	900	3 – 4	Place popcorn in a 1 litre container, cover and cook, sprinkle with sugar or salt after cooking
Chocolate coated marshmallows	20 g	600	0:10 – 0:20	Place on a plate, do not cover
Steeping oil for salad dressing	125 ml	150	1 – 2	Heat uncovered on a gentle heat
Tempering citrus fruits	150 g	150	1 – 2	Place on a plate, do not cover
Cooking bacon	100 g	900	2 – 3	Place on kitchen paper, do not cover
Softening ice cream	500 g	150	2	Place open container in the appliance
Skinning tomatoes	Qty 3	450	6 – 7	Cut a cross into the top of each tomato, cover, and heat in a little water. The skins will slip off easily. Take care, as the tomatoes may get very hot.
Strawberry jam	300 g strawberries, 300 g jam sugar	900	7 – 9	Mix the fruit and sugar in a deep container, cover and cook
Defrosting and baking part-baked bread rolls	2 rolls	150 + Grill Grill	1 – 2 4 – 6	Place uncovered on the rack, turning halfway through

The information given in this chart is intended only as a guide.

## Note for test institutes

Test food acc. to EN 60705	Microwave power level (W)+Grill/Automatic programme	Duration (min)/weight	Standing time* (min)	Notes
Custard, 1000 g	300	38–40	120	Container see Standard, dimensions at the upper rim (25 x 25 cm)
Sponge cake, 475 g	600	8	5	Container see Standard, external diameter at the upper rim 220 mm, cook uncovered
Minced meat, 900 g	600 450	7 12	5	Container see Standard, dimensions at the upper rim 250 mm x 124 mm, cook uncovered
Potato gratin, 1100 g	AC 8	1100 g	5	Container see Standard, external diameter at the upper rim 220 mm, cook uncovered
Chicken, 1200 g frozen weight, defrosted and halved	AC 5	1200 g	2	Grill rack with a heat-resistant, microwave-safe dish underneath, make sure the cut surfaces are facing upwards first, turn halfway through the cooking duration.
Defrost meat, (minced meat), 500 g	150	11	5–10	Container see Standard, do not cover, turn halfway through defrosting
Raspberries, 250 g	150	7	3	Container see Standard, defrost uncovered

\* Allow the food to stand at room temperature for the standing time specified to enable the heat to spread evenly throughout the food.

## Cleaning and care

To help prevent re-soiling, a conditioning agent for stainless steel (available from the Miele Customer Service Department) can be used. Use a soft cloth to apply sparingly with an even pressure.

Disconnect the microwave oven from the power supply before cleaning.

Under no circumstances should a pressure cleaner be used to clean the microwave oven.

The steam from a steam cleaning appliance could reach live electrical components and cause a short circuit.

### Housing, oven interior and inside of the door

 Risk of burning due to hot oven compartment.

The oven compartment may be too hot to clean immediately after use.

Clean the oven compartment as soon as it has cooled down.

 Fire hazard due to excessive soiling.

Excessive soiling could damage the appliance in certain circumstances and could even be dangerous due to the fire risk.

Do not wait too long to clean the appliance as this will make cleaning unnecessarily difficult and in extreme cases, impossible.

The oven compartment and the inside of the door can be wiped using a mild detergent or a little washing-up liquid and water. Wipe dry with a soft cloth.

For heavier soiling, heat a glass of water inside the oven compartment for 2 or 3 minutes until the water begins to boil. The steam will collect on the walls and soften the soiling. The oven interior can now be wiped clean using a little washing-up liquid if necessary.

Stainless steel surfaces can be treated with a conditioner for stainless steel (available from Miele).

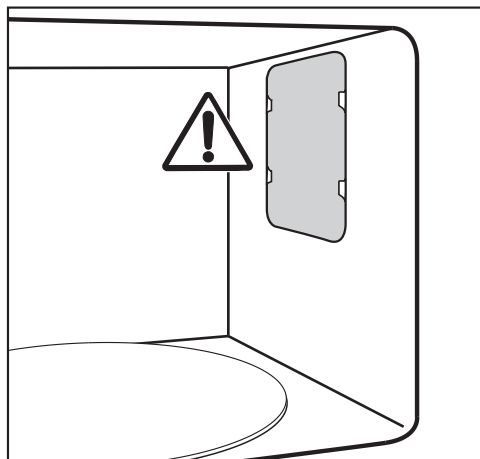

Do not remove the cover to the microwave outlet inside the oven, nor the film covering the inside of the door.

Do not let water or any object find its way into or block the air vents of the appliance.

Do not use too much water and do not let water or any other liquid find its way into any openings.

Do not use scouring agents. These will scratch.

To neutralise odours in the microwave oven compartment, put a cup of water with some lemon juice in the appliance and simmer for a few minutes.

 Health risk caused by a faulty appliance.

If any damage to the door is noticed, the appliance should not be used until the fault has been rectified by a Miele authorised and trained service technician. Operating a damaged appliance can result in microwave leakage and present a hazard to the user.

The door should be kept clean at all times and checked at regular intervals for any signs of damage. Do not use the microwave oven if:

- the appliance door is warped.
- the door hinges are loose.
- holes or cracks are visible in the casing, the door or the oven interior walls.

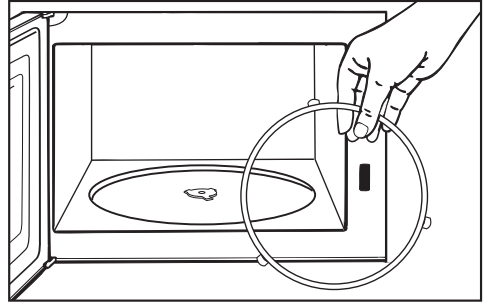

- Always keep the roller ring underneath it clean as well as the oven floor. Otherwise the turntable will not turn smoothly.
- Clean the surfaces between the turntable and the roller ring.

Do not turn the turntable and/or locator manually, as this could damage the drive motor.

### To clean the interior:

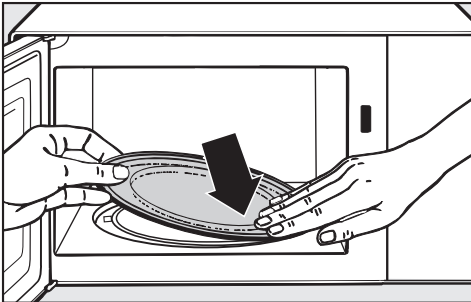

- Remove the turntable, and wash in the dishwasher or by hand.

# Cleaning and care

---

## Appliance front

Soiling that is left too long might become impossible to remove and could cause the surfaces to alter or discolour.

Remove any soiling on the front of the appliance straight away.

Clean the appliance front with a clean soft sponge and a solution of warm water and washing-up liquid. After cleaning, wipe dry using a soft cloth. A clean, damp microfibre cloth without cleaning agent can also be used.

All surfaces are susceptible to scratching. Scratches on glass can in some circumstances lead to breakage.

Contact with unsuitable cleaning agents can alter or discolour the external surfaces.

Please observe the cleaning instructions.

### To avoid damaging the surfaces of the appliance, do not use:

- detergents containing soda, ammonia, acids or chlorides
- cleaning agents containing descaling agents
- abrasive cleaning agents, e.g. scouring powder, scouring liquid, or pumice stones
- cleaning agents containing solvents
- stainless steel cleaning agents
- dishwasher cleaner
- oven sprays
- glass cleaning agents

- hard, abrasive sponges and brushes, e.g. pot scourers
- eraser stain remover blocks
- sharp metal scrapers

## Accessories supplied

### Rack

Wash and dry the rack after each use. It is dishwasher-proof. Remove stubborn soiling with a stainless steel cleaner.

### Gourmet plate

Clean the gourmet plate with hot water and a cloth with a little washing-up liquid to remove any grease.

Do not use wire wool, or abrasive sponges, aggressive or abrasive cleaning agents.

Do not clean the gourmet plate in a dishwasher.

If the gourmet plate has been used to cook food with a strong aroma, you can neutralise any odours by adding some water and lemon juice to the gourmet plate and heating it up in the microwave oven using maximum power for a 2-3 minutes. Rinse the gourmet plate afterwards with clean water.

# Problem solving guide

Many malfunctions and faults that can occur in daily operation can be easily remedied. Time and money will be saved because a service call will not be needed.

The following guide may help you to find the reason for a malfunction or a fault, and to correct it.

Problem	Cause and remedy
<p><b>A programme will not start.</b></p>	<p>Check whether:</p> <ul style="list-style-type: none"> <li>■ the appliance door is closed.</li> <li>■ the system lock has been activated (see “System lock” section in the “Operation” chapter).</li> <li>■ “door” has appeared in the display. The door has not been opened for a long time (approx. 20 minutes) (see “door message” section in the “Operation” chapter).</li> <li>■ the appliance is plugged into the electricity supply and switched on at the socket.</li> <li>■ the mains fuse has tripped. If it has, there could be a fault with the appliance, the household electricity supply or another appliance (disconnect the appliance from the electricity supply and contact a qualified electrician or the Miele Customer Service Department, see “Customer service” chapter).</li> </ul>
<p><b>A noise can be heard after a cooking programme.</b></p>	<p>This is not a fault. The cooling fan will continue to run for a while after the oven has been switched off to prevent any humidity building up in the oven compartment, on the control panel or on the oven housing unit. It will switch off automatically.</p>
<p><b>The display does not light up.</b></p>	<p>The time of day display has been switched off.</p> <ul style="list-style-type: none"> <li>■ Press and hold the ⌚ button for several seconds.</li> </ul> <p>Night time switch-off is activated.</p> <ul style="list-style-type: none"> <li>■ Deactivate it.</li> </ul>
<p><b>The turntable does not turn smoothly.</b></p>	<p>The area underneath the turntable could be dirty.</p> <ul style="list-style-type: none"> <li>■ Check whether there is any soiling underneath the turntable.</li> <li>■ Check whether the surfaces between the turntable and the roller ring are clean.</li> <li>■ Clean the area underneath the turntable.</li> </ul>

## Problem solving guide

Problem	Cause and remedy
<p><b>Food is not adequately defrosted, heated or cooked at the end of the selected cooking duration.</b></p>	<p>The duration or power level were insufficient to cook the food.</p> <ul style="list-style-type: none"> <li>■ Check whether the correct power level was selected for the duration set. The lower the power level, the longer the duration required.</li> <li>■ Check whether the programme has been interrupted and not restarted.</li> </ul>
<p><b>The microwave function is working but not the oven lighting.</b></p>	<p>The lamp is faulty. You can then operate the appliance as normal, but not the lighting.</p> <ul style="list-style-type: none"> <li>■ Contact Miele Customer Service if you need to replace the lighting.</li> </ul>
<p><b>Strange noises are heard when the microwave oven is being used.</b></p>	<p>The food is covered with aluminium foil.</p> <ul style="list-style-type: none"> <li>■ Remove the aluminium foil.</li> </ul> <hr/> <p>Sparks are being created by the use of crockery with a metallic finish.</p> <ul style="list-style-type: none"> <li>■ Please observe the information on suitable containers.</li> </ul>
<p><b>The time of day in the display is not accurate.</b></p>	<p>If there has been a power cut, the time automatically switches back to 12:00. The time of day needs to be reset.</p> <ul style="list-style-type: none"> <li>■ Set the correct time of day.</li> </ul>
<p><b>Food cools down too quickly.</b></p>	<p>In the microwave oven, food begins to cook from the outside first, the inside of the food relying on the slower conduction of heat. If food is cooked at a high power level, it is possible that the heat may not have reached the centre of the food, so it is hot on the outside but cold in the centre. During standing time heat is transferred to the centre of the food.</p> <ul style="list-style-type: none"> <li>■ When reheating food with different densities, such as plated meals, it is therefore sensible to select a lower power level and lengthen the duration required.</li> </ul>

## Problem solving guide

Problem	Cause and remedy
<b>The microwave oven switches itself off during a cooking, reheating or defrosting programme.</b>	There may be insufficient air circulation. ■ Check whether the air inlet or outlet is blocked. Remove any obstruction.
	The appliance switches off automatically in cases of overheating. ■ Cooking can be continued after a cooling-down period.
	The appliance switches itself off again. ■ Contact your Miele dealer.

## After sales service

---

### Contact in case of malfunction

In the event of any faults which you cannot remedy yourself, please contact your Miele Dealer or Miele Service.

Contact details for Miele are given at the end of this booklet. N.B. A call-out fee will be charged for service visits where the problem could have been resolved as described in these instructions.

When contacting your Dealer or Miele, please quote the model and serial number of your appliance.

This information can be found on the data plate located on the front of the oven interior.

### Warranty

The appliance warranty is valid for 2 years from date of purchase. In the UK, you must activate your cover by calling 0330 160 6640 or registering online at [www.miele.co.uk](http://www.miele.co.uk).

For further information, please refer to your warranty booklet.

## United Kingdom

Miele Co. Ltd., Fairacres, Marcham Road, Abingdon, Oxon, OX14 1TW

Tel: 0330 160 6600, Internet: [www.miele.co.uk/service](http://www.miele.co.uk/service), E-mail: [info@miele.co.uk](mailto:info@miele.co.uk)

### Australia

Miele Australia Pty. Ltd.

ACN 005 635 398

ABN 96 005 635 398

Level 4, 141 Camberwell Road

Hawthorn East, VIC 3123

Tel: 1300 464 353

Internet: [www.miele.com.au](http://www.miele.com.au)

### China Mainland

Miele Electrical Appliances Co., Ltd.

1-3 Floor, No. 82 Shi Men Yi Road

Jing' an District

200040 Shanghai, PRC

Tel: +86 21 6157 3500

Fax: +86 21 6157 3511

E-mail: [info@miele.cn](mailto:info@miele.cn),

Internet: [www.miele.cn](http://www.miele.cn)

### Hong Kong, China

Miele (Hong Kong) Ltd.

41/F - 4101, Manhattan Place

23 Wang Tai Road

Kowloon Bay, Hong Kong

Tel: (852) 2610 1025

Fax: (852) 3579 1404

Email:

[customerservices@miele.com.hk](mailto:customerservices@miele.com.hk)

Website: [www.miele.hk](http://www.miele.hk)

### India

Miele India Pvt. Ltd.

1st Floor, Copia Corporate Suites,

Commercial Plot 9,

Mathura Road, Jasola,

New Delhi - 110025

E-mail: [customercare@miele.in](mailto:customercare@miele.in)

Website: [www.miele.in](http://www.miele.in)

### Ireland

Miele Ireland Ltd.

2024 Bianconi Avenue

Citywest Business Campus

Dublin 24

Tel: (01) 461 07 10

Fax: (01) 461 07 97

E-Mail: [info@miele.ie](mailto:info@miele.ie)

Internet: [www.miele.ie](http://www.miele.ie)

### Malaysia

Miele Sdn Bhd

Suite 12-2, Level 12

Menara Sapura Kencana

Petroleum

Solaris Dutamas No. 1

Jalan Dutamas 1

50480 Kuala Lumpur, Malaysia

Phone: +603-6209-0288

Fax: +603-6205-3768

### New Zealand

Miele New Zealand Limited

IRD 98 463 631

8 College Hill

Freemans Bay, Auckland 1011

New Zealand

Tel: 0800 464 353

Internet: [www.miele.co.nz](http://www.miele.co.nz)

### Singapore

Miele Pte. Ltd.

29 Media Circle

#11-04 ALICE@Mediapolis

Singapore 138565

sTel: +65 6735 1191

Fax: +65 6735 1161

E-Mail: [info@miele.com.sg](mailto:info@miele.com.sg)

Internet: [www.miele.sg](http://www.miele.sg)

### South Africa

Miele (Pty) Ltd.

63 Peter Place

Bryanston 2194

P.O. Box 69434

Bryanston 2021

Tel: (011) 875 9000

Fax: (011) 875 9035

E-mail: [info@miele.co.za](mailto:info@miele.co.za)

Internet: [www.miele.co.za](http://www.miele.co.za)

### Thailand

Miele Appliances Ltd.

BHIRAJ TOWER at EmQuartier

43rd Floor Unit 4301-4303

689 Sukhumvit Road

North Klongton Sub-District

Vadhana District

Bangkok 10110, Thailand

### United Arab Emirates

Miele Appliances Ltd.

Showroom 1

Eiffel 1 Building

Sheikh Zayed Road, Umm Al Sheif

P.O. Box 114782 - Dubai

Tel. +971 4 3044 999

Fax. +971 4 3418 852

800-MIELE (64353)

E-Mail: [info@miele.ae](mailto:info@miele.ae)

Website: [www.miele.ae](http://www.miele.ae)

**Manufacturer:** Miele & Cie. KG, Carl-Miele-Straße 29, 33332 Gütersloh, Germany

M 6012 SC

en-GB

M.-Nr. 11 357 070 / 05