



DRAPER[®]

STORMFORCE

10.8V

ANGLE GRINDER/ CUT-OFF TOOL

98437



These instructions accompanying the product are the original instructions. This document is part of the product, keep it for the life of the product passing it on to any subsequent holder of the product. Read all these instructions before assembling, operating or maintaining this product.

This manual has been compiled by Draper Tools describing the purpose for which the product has been designed, and contains all the necessary information to ensure its correct and safe use. By following all the general safety instructions contained in this manual, it will ensure both product and operator safety, together with longer life of the product itself.

All photographs and drawings in this manual are supplied by Draper Tools to help illustrate the operation of the product.

Whilst every effort has been made to ensure the accuracy of information contained in this manual, the Draper Tools policy of continuous improvement determines the right to make modifications without prior warning.

1. TITLE PAGE

1.1 INTRODUCTION:

USER MANUAL FOR: 10.8V Angle Grinder/Cut-Off Tool

Stock No: 98437

Part No: CAG108SF

1.2 REVISIONS:

Date first published June 2020.

As our user manuals are continually updated, users should make sure that they use the very latest version.

Downloads are available from: <http://drapertools.com/manuals>

Draper Tools Limited
Hursley Road
Chandler's Ford
Eastleigh
Hampshire
SO53 1YF
UK

Website: drapertools.com

Product Help Line: +44 (0) 23 8049 4344

General Fax: +44 (0) 23 8026 0784

1.3 UNDERSTANDING THIS MANUALS SAFETY CONTENT:

Warning! – Information that draws attention to the risk of injury or death.

Important – Information that draws attention to the risk of damage to the product or surroundings.

1.4 COPYRIGHT © NOTICE:

Copyright © Draper Tools Limited.

Permission is granted to reproduce this publication for personal and educational use only. Commercial copying, redistribution, hiring or lending is prohibited.

No part of this publication may be stored in a retrieval system or transmitted in any other form or means without written permission from Draper Tools Limited.

In all cases this copyright notice must remain intact.

2. CONTENTS

2.1 TABLE OF CONTENTS

1. TITLE PAGE

1.1	INTRODUCTION:.....	2
1.2	REVISIONS:.....	2
1.3	UNDERSTANDING THIS MANUALS SAFETY CONTENT:.....	2
1.4	COPYRIGHT © NOTICE:.....	2

2. CONTENTS

2.1	TABLE OF CONTENTS	3
-----	-------------------------	---

3. WARRANTY

3.1	WARRANTY	4
-----	----------------	---

4. INTRODUCTION

4.1	SCOPE.....	5
4.2	SPECIFICATION	5
4.3	HANDLING AND STORAGE.....	5

5. HEALTH AND SAFETY INFORMATION

5.1	GENERAL SAFETY INSTRUCTIONS FOR POWER TOOL USE	6
5.2	SPECIFIC SAFETY INSTRUCTIONS FOR GRINDER USE	7
5.3	SAFETY RECOMMENDATIONS FOR THE CORRECT USE OF ABRASIVE PRODUCTS.....	8
5.4	SAFETY RECOMMENDATIONS FOR THE CORRECT USE OF SUPERABRASIVES.....	9
5.5	RESIDUAL RISK	10

6. TECHNICAL DESCRIPTION

6.1	IDENTIFICATION.....	11
-----	---------------------	----

7. UNPACKING AND CHECKING

7.1	PACKAGING	12
7.2	DRAPER 10.8V MULTI-TOOL INTERCHANGEABLE BATTERY SYSTEM	12
7.3	WHAT'S IN THE BOX	12

8. PREPARING THE ANGLE GRINDER

8.1	FITTING/REPLACING ACCESSORIES.....	13
8.2	MOUNTING CUTTING DISCS – FIGS.2 – 4	14
8.3	BATTERY PACK – FIG.5	14

9. OPERATION

9.1	ON/OFF SWITCH – FIG.6	15
9.2	GRINDING – FIG.7	15
9.3	CUTTING	15

10. MAINTENANCE AND TROUBLESHOOTING

10.1	MAINTENANCE.....	16
10.2	TROUBLESHOOTING GUIDE.....	16

11. DISPOSAL

11.1	DISPOSAL	17
------	----------------	----

12. EXPLANATION OF SYMBOLS

12.1	EXPLANATION OF SYMBOLS.....	18
------	-----------------------------	----

3. WARRANTY

3.1 WARRANTY

Draper tools have been carefully tested and inspected before shipment and are guaranteed to be free from defective materials and workmanship.

Should the tool develop a fault, please return the complete tool to your nearest distributor or contact:

Draper Tools Limited, Chandler's Ford, Eastleigh, Hampshire, SO53 1YF. England.

Telephone Sales Desk: (023) 8049 4333 or Product Help Line (023) 8049 4344.

A proof of purchase **must** be provided with the tool.

If upon inspection it is found that the fault occurring is due to defective materials or workmanship, repairs will be carried out free of charge. This warranty period covering labour is 12 months from the date of purchase except where tools are hired out when the warranty period is 90 days from the date of purchase. The warranty is extended to 24 months for parts only. This warranty does not apply to any consumable parts, any type of battery or normal wear and tear, nor does it cover any damage caused by misuse, careless or unsafe handling, alterations, accidents, or repairs attempted or made by any personnel other than the authorised Draper warranty repair agent.

Note: If the tool is found not to be within the terms of warranty, repairs and carriage charges will be quoted and made accordingly.

This warranty applies in lieu of any other warranty expressed or implied and variations of its terms are not authorised.

Your Draper warranty is not effective unless you can produce upon request a dated receipt or invoice to verify your proof of purchase within the warranty period.

Please note that this warranty is an additional benefit and does not affect your statutory rights.

Draper Tools Limited.

4. INTRODUCTION

4.1 SCOPE

This hand held power tool uses abrasive disks for cutting and grinding applications. It is intended for domestic and light commercial use only. Any other application is considered misuse.

4.2 SPECIFICATION

Stock No	98437	
Part No.	CAG108SF	
Revolutions per minute (no load):	18,500r/min	
Disc diameter:.....	76mm	
Spindle thread:	M5	
Bore:	10mm	
Max. cut depth	15mm	
Vibration level:		
Surface grinding:	ah,SG:0.95m/s2	
Cutting wheel:.....	ah:1.23m/s2	
Uncertainty (K):	1.5m/s2	
Sound pressure level*:	68.5dB(A)	
Uncertainty (K):	3dB(A)	
Sound power level**:.	79.5dB(A)	
Uncertainty (K):	3dB(A)	
Weight:	0.56kg	
Battery packs (sold separately):		
Stock No	92438	16254
Part No.	CB108LI4AH	CB108LI
Type	Li-ion	Li-ion
Rated Voltage	10.8V	10.8V
Rating	4.0Ah	1.5Ah
Chargers (sold separately):		
Stock No	16255	
Part No	C108LI	
Rated Voltage.....	230V~	
Rated Frequency	50Hz	
Rated output	35W	
Rated D.C. output voltage	10.8V	
Rated D.C. output current	2.0A	
Protective device rated current.....	2A	
Construction	Class II	

* *Continuous A-Weighted Sound Pressure Level at the workstation in accordance to and declared according to EN60745.*

** *The typical A-weighted noise level determined according to EN60745.*

4.3 HANDLING AND STORAGE

- Care must be taken when handling this product.
 - Dropping this power tool could have an effect on its accuracy and could also result in personal injury. This product is not a toy and must be respected.
- Environmental conditions can have a detrimental effect on this product if neglected.
 - Exposure to damp air can gradually corrode components. If the product is unprotected from dust and debris, components will become clogged.
 - If not cleaned and maintained correctly or regularly, the machine will not perform at its best.

5. HEALTH AND SAFETY INFORMATION

5.1 GENERAL SAFETY INSTRUCTIONS FOR POWER TOOL USE

When using any type of power tool there are steps that should be taken to make sure that you, as the user, remain safe.

Common sense and a respect for the tool will help reduce the risk of injury.

Read the instruction manual fully. Do not attempt any operation until you have read and understood this manual.

Most important you must know how to safely start and stop this machine, especially in an emergency.

Keep the work area tidy and clean. Attempting to clear clutter from around the machine during use will reduce your concentration. Mess on the floor creates a trip hazard. Any liquid spilt on the floor could result in you slipping.

Find a suitable location. If the machine is bench mounted, the location should provide good natural light or artificial lighting as a replacement. Avoid damp and dust locations as it will have a negative effect on the machine's performance. If the machine is portable do not expose the tool to rain. In all cases do not operate power tools near any flammable materials.

Keep bystanders away. Children, onlookers and passers by must be restricted from entering the work area for their own protection. The barrier must extend a suitable distance from the tool user.

Unplug and house all power tools that are not in use. A power tool should never be left unattended while connected to the power supply. They must be housed in a suitable location, away locked up and from children. This includes battery chargers.

Do not overload or misuse the tool. All tools are designed for a purpose and are limited to what they are capable of doing. Do not attempt to use a power tool (or adapt it in any way) for an application it is not designed for. Select a tool appropriate for the size of the job. Overloading a tool will result in tool failure and user injury. This covers the use of accessories.

Dress properly. Loose clothing, long hair and jewellery are all dangerous because they can become entangled in moving machinery. This can also result in parts of body being pulled into the machine. Clothing should be close fitted, with any long hair tied back and jewellery and neck ties removed. Footwear must be fully enclosed and have a non-slip sole.

Wear personal protective equipment (PPE). Dust, noise, vibration and swarf can all be dangerous if not suitably protected against. If the work involving the power tool creates dust or fumes wear a dust mask. Vibration to the hand, caused by operating some tools for longer periods must be protected against. Wear vibration reducing gloves and allow long breaks between uses. Protect against dust and swarf by wearing approved safety goggles or a face shield. These are some of the more common hazards and preventions, however, always find out what hazards are associated with the machine/work process and wear the most suitable protective equipment available.

Do not breathe contaminated air. If the work creates dust or fumes connect the machine (if possible) to an extraction system either locally or remotely. Working outdoors can also help if possible.

Move the machine as instructed. If the machine is hand held, do not carry it by the power supply cable. If the product is heavy, employ a second or third person to help move it safely or use a mechanical device. Always refer to the instructions for the correct method.

Do not overreach. Extending your body too far can result in a loss of balance and you falling. This could be from a height or onto a machine and will result in injury.

Maintain your tools correctly. A well maintained tool will do the job safely. Replace any damaged or missing parts immediately with original parts from the manufacturer. As applicable, keep blades sharp, moving parts clean, oiled or greased, handles clean, and emergency devices working.

Wait for the machine to stop. Unless the machine is fitted with a safety brake, some parts may continue to move due to momentum. Wait for all parts to stop, then unplug it from the power supply before making any adjustments, carrying out maintenance operations or just finishing using the tool.

5. HEALTH AND SAFETY INFORMATION

Remove and check setting tools. Some machinery requires the use of additional tools or keys to set, load or adjust the power tool. Before starting the power tool always check to make certain they have been removed and are safely away from the machine.

Prevent unintentional starting. Before plugging any machine in to the power supply, make sure the switch is in the OFF position. If the machine is portable, do not hold the machine near the switch and take care when putting the machine down, that nothing can operate the switch.

Carefully select an extension lead. Some machines are not suitable for use with extension leads. If the tool is designed for use outdoors, use an extension lead also suitable for that environment. When using an extended lead, select one capable of handling the current (amps) drawn by the machine in use. Fully extend the lead regardless of the distance between the power supply and the tool. Excess current (amps) and a coiled extension lead will both cause the cable to heat up and can result in fire.

Concentrate and stay alert. Distractions are likely to cause an accident. Never operate a power tool if you are under the influence of drugs (prescription or otherwise), including alcohol or if you are feeling tired. Being disorientated will result in an accident.

Have this tool repaired by a qualified person. This tool is designed to conform to the relevant international and local standards and as such should be maintained and repaired by someone qualified, using only original parts supplied by the manufacturer. This will ensure the tool remains safe to use.

5.2 SPECIFIC SAFETY INSTRUCTIONS FOR GRINDER USE

Have this tool repaired by a qualified person. This tool is designed to conform to the relevant international and local standards. As such, it should be maintained and repaired by someone qualified, using only original parts supplied by the manufacturer – This will ensure the tool remains safe to use.

- Check that speed marked on the wheel is equal to or greater than the rated speed of the grinder.
- Ensure that the wheel dimensions are compatible with the grinder.
- Abrasive wheels must be stored and handled with care in accordance with manufacturer's instructions.
- Inspect the grinding wheel before use. Do not use chipped, cracked or otherwise defective products.
- Ensure that mounted wheels and points are fitted in accordance with the manufacturer's instructions.
- Ensure that the abrasive product is correctly mounted and tightened before use.
Run the tool at no-load for 30 seconds in a safe position.
Stop immediately if there is considerable vibration or if other defects are detected. If this condition occurs, check the machine to determine the cause.
- Never use the angle grinder without the safety guard.
- Do not use separate reducing bushings or adapters to adapt large hole abrasive wheels.
- Check that the work piece is properly supported.
- Do not use cutting wheel for side grinding.
- Ensure that sparks resulting from use do not create a hazard e.g. do not hit persons, to ignite flammable substances.
- Always use eye and ear protection.
- Personal protective equipment such as dust mask, gloves, helmet and apron should be worn.
- The wheel continues to rotate after the tool is switched off.

Warning! Prior to mounting an abrasive wheel ensure the expiry date has not exceeded rendering it potentially hazardous.

5. HEALTH AND SAFETY INFORMATION

Secure work. Use clamps or a vice to hold the work. It is safer than using your hands and it frees both hands to operate the tool.

Stay alert. Watch what you are doing. Use common sense. Do not operate tool when you are tired.

Wear proper clothing. Do not wear loose clothing, neckties or jewellery (ring, wristwatches etc.) to catch in moving parts. Non-slip footwear is recommended. Wear protective covering to contain long hair. Roll long sleeves above the elbow.

Use safety goggles (Head protection). Wear goggles approved to the relevant standards at all times. Normal spectacles only have impact resistant lenses, they are NOT safety glasses. Also, use face or dust mask if application is dusty and ear protectors during all operations.

Sound levels. Some types of machines may have high sound levels when working. In such cases ear protection must be worn.

Vibration levels. Hand held power tools produce different vibration levels. You should always refer to the specifications and the relevant Health and Safety guidelines.

Dust extraction. If your tool is fitted with a dust extraction facility, always ensure that it is connected and being used with a dust extractor. Vacuum cleaners can be used if suitable for the material being extracted.

Check damaged parts. Before use, any blade guard or other part that is damaged should be carefully checked to determine that it will operate properly and perform its intended function. Check for alignment of moving parts, free running of moving parts, breakage of parts, mounting and any other conditions that may affect its operation. A guard or other part that is damaged should be properly repaired or replaced by an authorised service centre unless otherwise indicated in this instruction manual. Have defective switches replaced by an authorised service centre. Do not use the tool if the switch does not turn it on and off.

Have your tool repaired by a qualified person. Use of this electric tool is in accordance with the relevant safety requirements. Repairs should only be carried out by qualified persons using original spare parts, otherwise this may result in considerable danger to the user.

5.3 SAFETY RECOMMENDATIONS FOR THE CORRECT USE OF ABRASIVE PRODUCTS

General. Bonded abrasive products are breakable and shall therefore be handled with utmost care. The use of damaged or improperly mounted or used abrasive products is dangerous and can cause serious injuries.

Delivery, handling and storage. Abrasive products must be handled and transported with care. Abrasive products must be stored in such a manner that they are not subjected to mechanical damaged and harmful environmental influences.

Selection of the abrasive product. Information on the label or the abrasive product stating restrictions of use, safety indications or any other instructions must be followed. In case of doubt concerning the selection of abrasive products, the user shall request information from the manufacturer or supplier.

Visual inspection and ring test. Abrasive products must be subjected to a visual inspection as received before mounting. In addition, a ring test shall be executed for vitrified wheels with $D > 80\text{mm}$. Damaged abrasive products shall be destroyed.

Mounting before starting and information for grinding. The mounting of abrasive products shall be carried out according to the instructions provided by both the wheel and the machine manufacturer. Mounting of abrasive products must be carried out by a qualified trained person. After initial mounting, the wheel must be test run for a reasonable time – the specified maximum operating speed of the wheel shall not be exceeded.

Further information. The following instructions must be observed, supplementary to the information contained in the instruction for use of the grinding machine:

5. HEALTH AND SAFETY INFORMATION

- Observance of the user's information from the grinding machine manufacturer.
- Safety devices shall be mounting to the machine and shall be secured.
- No grinding operations without protection by safety devices.
- Use of personal protective equipment according to the type of machine and type of application, e.g. eye and face protection, ear protection, respiratory protective devices, protective footwear, protective gloves and other protective clothing.
- Only grinding operations for which the abrasive product is suitable shall be carried out (taking into account restrictions of use, safety indications or other information).
- Jamming of the hand-held grinding machine shall be prevented. In the case of cutting-off with hand-held grinding machines, the abrasive product shall be placed in the cutting gap in a straight position.
- Before placing the hand-held grinding machine on the workbench or on the floor it shall be turned off and it shall be ensured that the abrasive product has stopped.

5.4 SAFETY RECOMMENDATIONS FOR THE CORRECT USE OF SUPERABRASIVES

General. Superabrasives are breakable and shall therefore be handled with utmost care! The use of damaged or improperly mounted or used superabrasives is dangerous and can cause serious injuries.

Delivery, handling and storage. Superabrasives shall be handled and transported with care. Superabrasives shall be stored in such a manner that they are not subjected to mechanical damages and harmful environmental influences.

Selection of superabrasives. Information on the label or the superabrasive as well as restrictions of use, safety indications or any other instruction shall be followed. In case of doubt concerning the selection of superabrasives, the user shall request information from the manufacturer or supplier.

Visual inspection and ring test. Superabrasives shall be subjected to a visual inspection as received before mounting. In a addition, a ring test shall be executed for superabrasives with vitrified core and abrasive section and $D > 80\text{mm}$. Damaged superabrasives shall not be used.

Mounting, before starting and information for grinding. The mounting of superabrasive shall be carried out according to the instructions provided by both, the superabrasive and the machine manufacturer. Special attention shall be drawn to the fact that mounting of superabrasives is to be carried out by a qualified trained person. Each time after mounting, the superabrasive shall be test run for a reasonable time - the specified maximum operating speed of the superabrasive shall not be exceeded.

Further information. The following instructions shall be observed, supplementary to the information of the grinding machine:

- Observance of the user's information of grinding machine manufacturer.
- Before starting, safety devices shall be mounted to the machine.
- No grinding operations without protection by safety devices.
- Use of personal protective equipment according to the type of machine and type of application, e.g. eye and face protection, ear protection, respiratory protection devices, protective footwear, protective gloves and other protective clothing.
- Only grinding operations for which the superabrasive is suitable shall be carried out (taking into account restrictions of use, safety indications or other information).
- In the case of cutting-off with hand-held grinding machines, the superabrasive shall be placed in the cutting gap in a straight position. Jamming of the hand-held grinding machine shall be prevented.
- Before placing the hand-held grinding machine on the workbench or on the floor it shall be turned off and it shall be ensured that the abrasive product has stopped.

5. HEALTH AND SAFETY INFORMATION

5.5 RESIDUAL RISK

Important note: Although the safety instructions and operating manuals for our tools contain extensive instructions for safe working with power tools, every power tool involves a certain residual risk which can not be completely excluded by safety mechanisms. Power tools must therefore always be operated with caution!

6. TECHNICAL DESCRIPTION

6.1 IDENTIFICATION

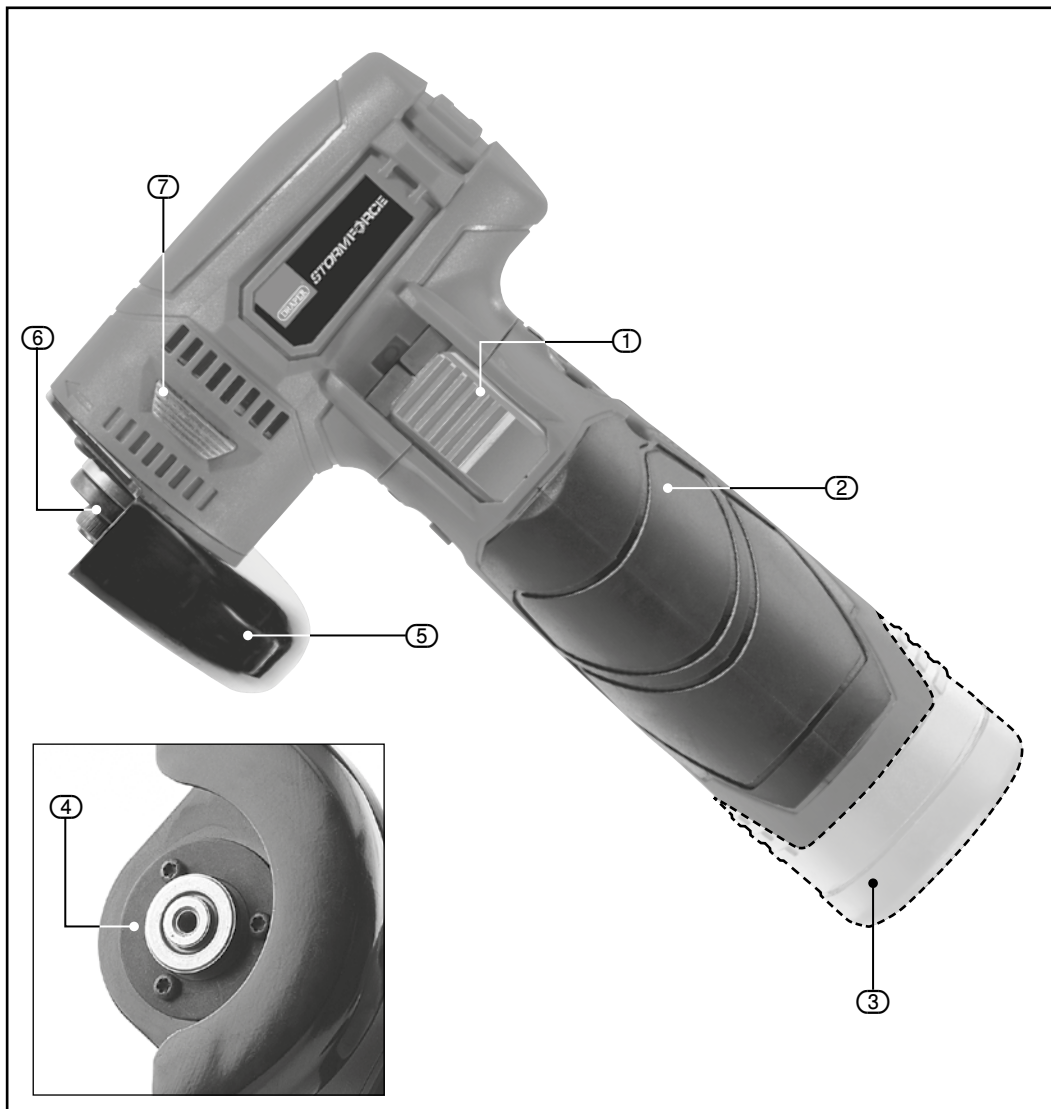

① On/Off switch.

② Soft grip.

③ 10.8V 1.5Ah Li-ion battery pack
(sold separately).

④ Rear flange.

⑤ Safety guard.

⑥ Locking flange.

⑦ Spindle lock button.

7. UNPACKING AND CHECKING

7.1 PACKAGING

Carefully remove the product from the packaging and examine it for any sign of damage that may have happened during shipping. Lay the contents out and check them against the parts shown below. If any part is damaged or missing, please contact the Draper Help Line (the telephone number appears on the Title page) and do not attempt to use the product.

The packaging material should be retained at least during the warranty period, in case the machine needs to be returned for repair.

Warning! Some of the packaging materials used may be harmful to children. Do not leave any of these materials in the reach of children.

If any of the packaging is to be thrown away, make sure they are disposed of correctly, according to local regulations.

7.2 DRAPER 10.8V MULTI-TOOL INTERCHANGEABLE BATTERY SYSTEM

This tool is supplied **without** a battery, and **without** a charger. These optional accessories are available.

The Draper 10.8V multi-tool interchangeable range features an array of machines all running from the same batteries and charger. To find out the latest range of accessories including batteries and charger please consult the Draper website for more information or to find your local Draper stockist.

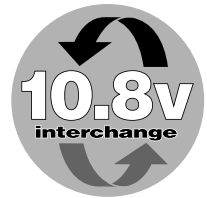

7.3 WHAT'S IN THE BOX

As well as the main product, there may be parts included that are not fitted or attached.

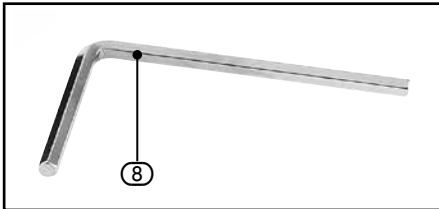

⑧ Hex. key.

8. PREPARING THE ANGLE GRINDER

8.1 FITTING/REPLACING ACCESSORIES

Warning! Prior to mounting an abrasive wheel ensure the expiry date has not expired, rendering it potentially hazardous.

Warning! Selection of the correct accessory, suitable for the intended application is vital. Seek guidance if uncertain of selection.

Warning! The rated (no load) revolutions per minute of the tool must not exceed the speed capacity of the accessory. Please refer to the accessory manufacturers instructions for information.

Visual Inspection:

- Prior to fitting, abrasive/superabrasive wheels shall be subject to a visual inspection.

Inspection:

- Each time after mounting, the abrasive/superabrasive wheel shall be test run for a reasonable time.
- The specified maximum operating speed of the wheel shall not be exceeded.
- Damaged abrasives shall be destroyed.
- Always wear approved safety goggles.

8. PREPARING THE ANGLE GRINDER

8.2 MOUNTING CUTTING DISCS – FIGS.2 – 4

- Press and hold the spindle lock button (7).
- Loosen the locking flange (6) anti-clockwise using the hex. key (8) supplied.
- The spindle may rotate slightly before the spindle lock fully engages.
- Remove the locking flange only.
- Clean the flanges and spindle prior to fitting any accessory.
- Securely tighten the locking flange clockwise using the hex. key (8) while holding down the spindle lock button (7).

Note: When using wire cup brushes the locking flange is not required due to the design of the brushes. When fitted check the accessory is correct and, importantly fully secure on the spindle.

Warning! Never press the spindle lock button (3) while the spindle is in motion.

8.3 BATTERY PACK – FIG.5

Note: This power product is supplied “bare”, without battery pack or charger. Draper 10.8V multi-tool interchange battery packs and chargers are available separately through all local Draper Tools stockists.

Important: Only Draper 10.8V designated battery packs and chargers can be used in conjunction with this product. Use of any other third party battery packs/chargers with this product is considered misuse and will invalidate the product's warranty.

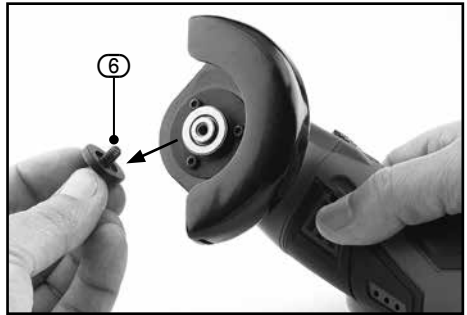

FIG.1

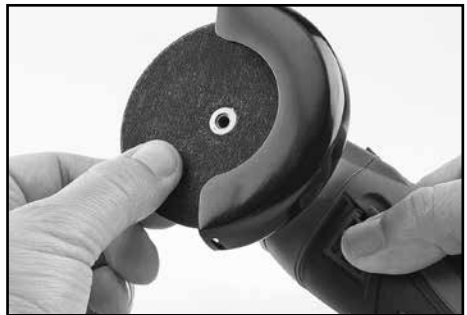

FIG.2

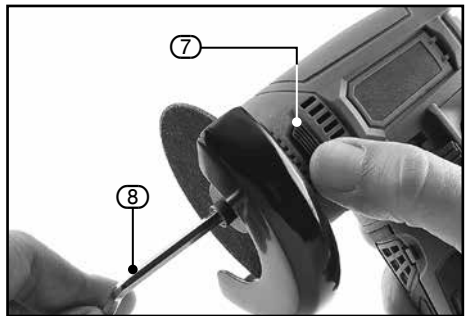

FIG.3



FIG.4

9. OPERATION

9.1 ON/OFF SWITCH – FIG.6

- To start the power tool, push the ON/OFF switch ① forward.
- To lock the ON/OFF switch ①, press the switch down at the front until it latches.
- To switch off the power tool, release the ON/OFF switch ① or, if it is locked, briefly push down the back of the switch and then release it.

Warning! Do not set the machine down until the spindle has completely stopped.

Note: During use, keep clothing out of the line of any sparks formed. Sparks from metal grinding can set fire to many types of clothing in a short time. The risk is less if your outer clothing is made of wool, or flame retardant treated cotton.

Dust: A correctly fitted dust mask, suitable for the activity and in accordance to the relevant standard, must be worn.

9.2 GRINDING – FIG.7

When performing grinding operations maintain an angle of approximately 30° between the work surface and the disc face.

Only use abrasives specifically designed for this task.

9.3 CUTTING



Important legal information:

- Cutting operations should only be attempted in conjunction with the guard fitted to this grinder.
- This guard must be fitted for your safety.
- When performing cutting-off operations do not incline the machine as this can lead to the abrasive wheel becoming jammed, damaged or excessively and abnormally worn.
- Only use abrasives specifically designed for this task.

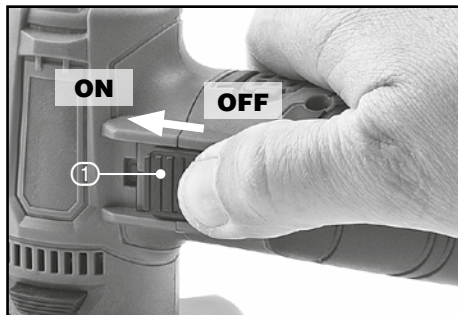

FIG.5



FIG.6

Warning! As the abrasive wheel wears during use, its diameter reduces. This reduces the peripheral speed and the machine's efficiency. This results in increased load on the grinding machine which if continued will damage the motor. Ensure that the diameter of the wheel is within 25% of its original size.

Important: Excessive pressure on the machine does not result in a higher abrasive efficiency. Excessive pressure increases wear and tear on the accessory and will damage the angle grinder which is not covered under the guarantee.

10. MAINTENANCE AND TROUBLESHOOTING

10.1 MAINTENANCE

Regular inspection and cleaning reduces the necessity for maintenance operations and will keep your tool in good working condition.

The motor must be correctly ventilated during tool operation. Avoid blocking the air inlets and vacuum the ventilation slots regularly.

10.2 TROUBLESHOOTING GUIDE

Problem	Possible Cause	Remedy
Motor does not start.	1. Battery pack no charge.	1. Re-charge battery.
	2. Battery faulty or damaged.	2. Replace battery.
Motor runs, but slowly/ losing power.	1. Battery pack no charge.	1. Re-charge battery.
	2. Battery pack faulty or damaged.	2. Replace battery.
Battery pack doesn't charge / non-illumination / non illumination of charger.	1. Fuse blown in charger plug.	1. Replace fuse.
	2. Charger faulty.	2. Replace charger.

11. DISPOSAL

11.1 DISPOSAL

- At the end of the machine's working life, or when it can no longer be repaired, ensure that it is disposed of according to national regulations.
- Contact your local authority for details of collection schemes in your area.

In all circumstances:

- Do not dispose of power tools with domestic waste.
- Do not incinerate.
- Do not dispose of WEEE* as unsorted municipal waste.



Li-ion

* *Waste Electrical & Electronic Equipment.*

12. EXPLANATION OF SYMBOLS

12.1 EXPLANATION OF SYMBOLS



Read the instruction manual.



Wear face mask and safety glasses.



Wear ear defenders.



Wear protective gloves.



Do not abandon into the environment.



Keep out of the reach of children.



Warning!



Do not incinerate or throw onto fire.



For indoor use only.
Do not expose to rain.



Fuse protective device.



Polarity indication.



Rated voltage.



Class II construction
(Double insulated).



Li-ion

Lithium-ion product.



WEEE –
Waste Electrical & Electronic Equipment.
Do not dispose of Waste Electrical & Electronic
Equipment in with domestic rubbish.



Continuous A-Weighted Sound
Pressure Level in accordance to and
declared according to EN60745.

CONTACTS

Draper Tools Limited, Hursley Road,
Chandler's Ford, Eastleigh, Hampshire. SO53 1YF. U.K.

Help Line: (023) 8049 4344

Sales Desk: (023) 8049 4333

Internet: drapertools.com

E-mail: sales@drapertools.com

General Enquiries: (023) 8026 6355

Service/Warranty Repair Agent:

For aftersales servicing or warranty repairs, please contact the Draper Tools Help Line for details of an agent in your local area.

YOUR DRAPER STOCKIST

TACH0620

©Published by Draper Tools Limited.

No part of this publication may be reproduced, stored in a retrieval system or transmitted in any form or by any means, electronic, mechanical photocopying, recording or otherwise without prior permission in writing from Draper Tools Ltd.