

Body-Solid®
Built for Life

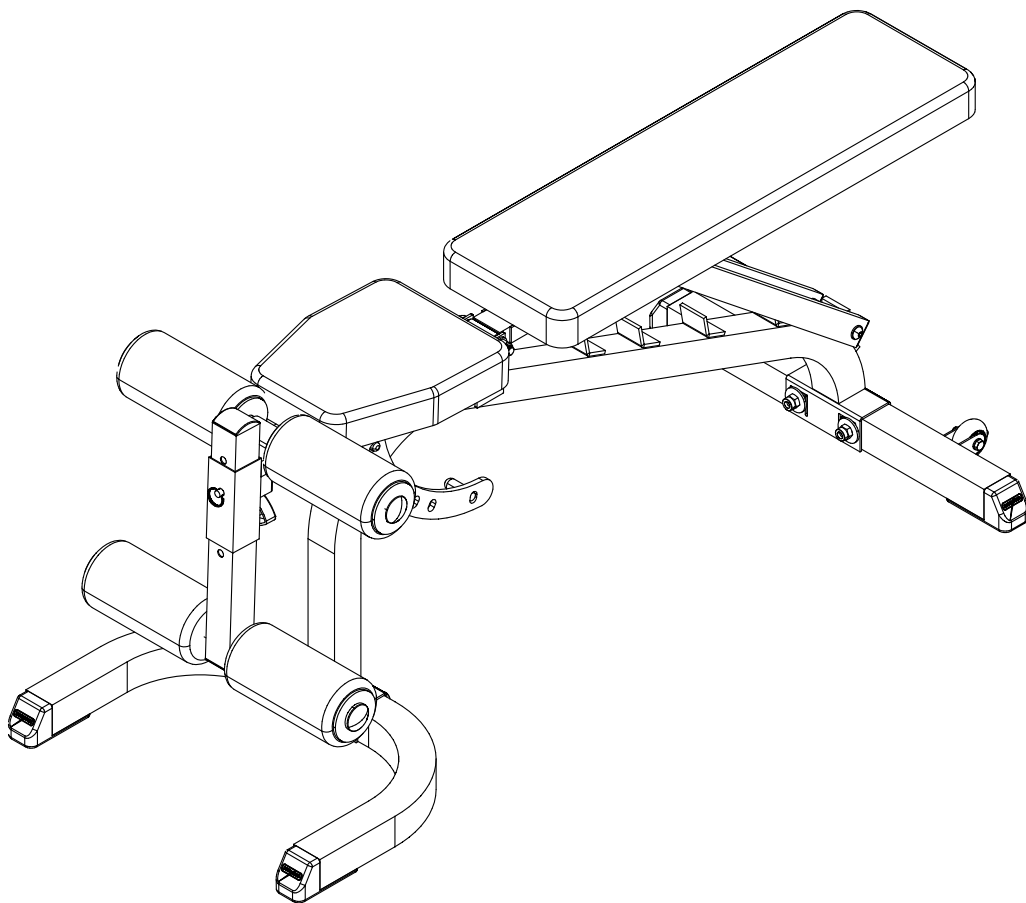

GFID-31

Flat/Incline/Decline Bench

Assembly

Instructions

OWNER'S

&

MANUAL

GFID71_080811

Warning, Safety & Maintenance

Be sure that all users carefully read and understand all warning, safety and maintenance labels on the machine before each use. Failure to do so may result in death or serious injury.

It is imperative that you retain this Owner's Manual and be sure all warning labels are legible and intact. Replacement Owner's Manuals and warning labels are available from your local Body-Solid dealer.

If you have any questions about the operation, set up or maintenance of this machine please call our customer service department at 1 (800) 556-3113.

THERE IS A RISK ASSUMED BY INDIVIDUALS WHO USE THIS TYPE OF EQUIPMENT. TO MINIMIZE RISK, YOU MUST FOLLOW THESE RULES:

Inspect equipment before each workout. Check that all nuts, bolts, screws and pop pins are in place and fully tightened. Also, before use, check cables for sign of wear. Replace all worn parts immediately. Never use machine if any parts are damaged or missing.

FAILURE TO FOLLOW THESE RULES MAY RESULT IN SERIOUS INJURY.

Keep clear of the cables and all moving parts when machine is in use.
 Always make sure all Snap Links are closed when doing cable/pulley/strap exercises.
 Exercise with care. Perform your exercises at a smooth moderate pace; never perform jerky or uncoordinated movements that may cause injury.
 It is recommended that you workout with a training partner.
 Do not allow children or minors to play on or around this equipment.
 If unsure of proper use of equipment, call your local Body-Solid distributor or the Body-Solid customer service center at 1-800-556-3113.
WARNING: Consult your physician before starting your exercise program. For your own safety, do not begin any exercise program without proper instruction.

MAINTENANCE SCHEDULE

Check the function and integrity of the following components. As noted, inspect equipment before each workout. Replace all damaged, broken or worn components immediately.

Cables:	Check tension, end fittings, and coating	✓
	Check that locking nut at weight stack is tight	✓
Upholstery:	Wipe down and dry	✓
	Clean and condition	✓
Frame:	Wipe down and dry	✓
	Polish / Wax	✓
Chrome:	Wipe down and dry	✓
	Polish / Lubricate	✓
Nut / Bolts / Fasteners:	Tighten and / or adjust as needed	✓
Guide Rods:	Lubricate and clean	✓
Linear Rods:	Lubricate and clean	✓
Seat Sleeves:	Lubricate and clean	✓
Adjustments / Locking Pins / Tightening Knobs		✓
Weight Stack Pins		✓
Warning Instruction Labels		✓
Springs / Pop Pins		✓
Anti Skid Surfaces		✓
Hand Grips / Rollers		✓

For Body-Solid Customer Service
Call 1-800-556-3113
 #MSSKR0808



CAUTION:

To avoid pinch point, do not adjust the back pad while on the bench and always use two hands to grab a hold of the handle and the pad while adjusting.

Table of Contents

- SAFETY INSTRUCTIONS..... PAGE 4
- PREPARATION..... PAGE 5
- HARDWARE LIST..... PAGE 6
- HARDWARE ILLUSTRATION..... PAGE 7
- PART / LIST ILLUSTRATION..... PAGE 10
- ASSEMBLY INSTRUCTIONS..... PAGE 12
- EXPLODED VIEW..... PAGE 21
- CONTACT PAGE..... PAGE 22

Important Safety Instructions

Before beginning any fitness program, you should obtain a complete physical examination from your physician.

Il est conseillé de subir un examen médical complet avant d'entreprendre tout programme d'exercice.

Si vous avez des étourdissements ou des faiblesses, arrêtez les exercices immédiatement.

Antes de comenzar cualquier programa de ejercicios, deberías tener un examen físico con su doctor.

When using exercise equipment, you should always take basic precautions, including the following:

- Read all instructions before using the GFID-31. These instructions are written to ensure your safety and to protect the unit.
- Do not allow children on or near the equipment.
- Use the equipment only for its intended purpose as described in this guide. Do not use accessory attachments that are not recommended by the manufacturer. Such attachments might cause injuries.
- Wear proper exercise clothing and shoes for your workout, no loose clothing.
- Use care when getting on or off the unit.
- Do not overexert yourself or work to exhaustion.
- If you feel any pain or abnormal symptoms, stop your workout immediately and consult your physician.
- Never operate unit when it has been dropped or damaged. Return the equipment to a service center for examination and repair.
- Never drop or insert objects into any opening in the equipment.
- Always check the unit and its cables before each use. Make sure that all fasteners and cables are secure and in good working condition.
- Do not use the equipment outdoors or near water.

Personal Safety During Assembly

- Before beginning assembly, please take the time to read the instructions thoroughly.
- Read each step in the assembly instructions and follow the steps in sequence. Do not skip ahead. If you skip ahead, you may learn later that you have to disassemble components and that you may have damaged the equipment.
- Assemble and operate the GFID-31 on a solid, level surface. Locate the unit a few feet from the walls or furniture to provide easy access.

The GFID-31 is designed for your enjoyment. By following these precautions and using common sense, you will have many safe and pleasurable hours of healthful exercise with your Body-Solid GFID-31.

After assembly, you should check all functions to ensure correct operation. If you experience problems, first recheck the assembly instructions to locate any possible errors made during assembly. If you are unable to correct the problem, call the dealer from whom you purchased the machine or call 1-800-556-3113 for the dealer nearest you.

Obtaining Service

Please use this Owner's Manual to make sure that all parts have been included in your shipment. When ordering parts, you must use the part number and description from this Owner's Manual. Use only Body-Solid replacement parts when servicing this machine. Failure to do so will void your warranty and could result in personal injury.

For information about product operation or service, check out the official Body-Solid website at www.bodysolid.com or contact an authorized Body-Solid dealer or a Body-Solid factory-authorized service company or contact Body-Solid customer service at one of the following:

Toll Free: 1-800-556-3113
Phone: 1-708-427-3555
Fax: 1-708-427-3556
Hours: M-F 8:30-5:00 CST
E-Mail: service@bodysolid.com

Or write to: Body-Solid, Inc.
Service Department
1900 S. Des Plaines Ave.
Forest Park, IL 60130 USA

Retain this Owner's Manual for future reference. If you need to order replacement parts please be prepared to provide the following information when contacting us so that we can assist you better.

- 1. Model Number**
- 2. Place of Purchase**
- 3. Serial Number (S/N)**
- 4. Part # and Description**

GFID-31 Preparation

Thank you for purchasing the GFID-31. This bench is part of the Body-Solid line of quality strength training machines, which lets you target specific muscle groups to achieve better muscle tone and overall body conditioning. To maximize your use of the equipment please study this Owner's Manual thoroughly.

Required Tools

The basic tools that you must obtain before assembling the GFID-31 include but are not limited to:

- Metric Allen Key Set
- Standard Allen Key Set
- Standard Wrench Set
- Metric Wrench Set
- Adjustable Wrench
- Screwdriver (standard and/or phillips)
- Rubber Mallet

Installation Requirements

Follow these installation requirements when assembling the GFID-31:

Set up the GFID-31 on a solid, flat surface. A smooth, flat surface under the machine helps keep it level. A level machine has fewer malfunctions.

Provide ample space around the machine. Open space around the machine allows for easier access.

Insert all bolts in the same direction. For aesthetic purposes, insert all bolts in the same direction unless specified (in text or illustrations) to do otherwise.

Leave room for adjustments. Tighten fasteners such as bolts, nuts, and screws so the unit is stable, but leave room for adjustments. Do not fully tighten fasteners until instructed in the assembly steps to do so.

Fill out and mail the warranty card.

Assembly Tips

Read all "Notes" on each page before beginning each step.

While you may be able to assemble the GFID-31 using the illustrations only, important safety notes and other tips are included in the text.

Some pieces may have extra holes that you will not use. Use only those holes indicated in the instructions and illustrations.

NOTE: With so many assembled parts, proper alignment and adjustment is critical. While tightening the nuts and bolts, be sure to leave room for adjustments.

NOTE: The bottles that are marked "Poison" is your touch up paint. Keep away from children.

CAUTION: Obtain assistance! If you feel like you can't assemble the GFID-31 by yourself then do not attempt to do so as this could result in injury. Review the installation requirements before proceeding with the following steps.

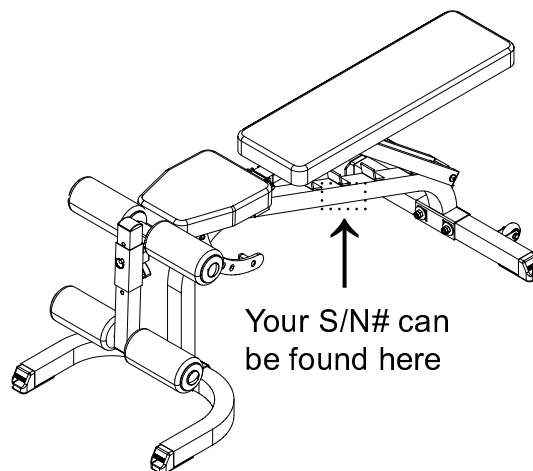

Body-Solid continually seeks ways to improve the performance, specifications and product manuals in order to ensure that only superior products are released from our factories. Please take the time to carefully read through this manual thoroughly. Instructions contained in this document are not intended to cover all details or variations possible with Body-Solid equipment, or to cover every contingency that may be met in conjunction with installation, operation, maintenance or troubleshooting of the equipment. Even though we have prepared this manual with extreme care, neither the publisher nor the author can accept responsibility for any errors in, or omission from, the information given. Should additional information be required, or should situations arise that are not covered by this manual, the matter should be directed to your local Body-Solid representative, or the Service Department at Body-Solid Inc. in Forest Park, Illinois.

Hardware List

Part#	Size	Description	Quantity
1	M12X75mm	HEX HEAD BOLT	4 PCS.
2	M10X15mm	HEX HEAD BOLT	4 PCS.
3	M8X45mm	HEX HEAD BOLT	2 PCS.
4	1/2"X3"	HEX HEAD BOLT	2 PCS.
5	5/16"X1"	HEX HEAD BOLT	8 PCS.
6	M12	NYLON LOCK NUT	4 PCS.
7	M8	NYLON LOCK NUT	2 PCS.
8	1/2"	NYLON LOCK NUT	2 PCS.
9	M12	WASHER	8 PCS.
10	M10	WASHER	4 PCS.
11	M8	WASHER	4 PCS.
12	1/2"	WASHER	4 PCS.
13	5/16"	SPRING WASHER	8 PCS.
14	5/16"	WASHER	8 PCS.
15		RING PIN	1 PCS.
16	45X45mm	END CAP	2 PCS.
17	20X40mm	END CAP	4 PCS.
18	1"X2"	END CAP	1 PCS.
19	2"X2"	FOOT CAP	4 PCS.
20	64mm	RUBBER WHEEL	2 PCS.
21	3"	NYLON WASHER	6 PCS.
22	1"	ROUND END CAP	4 PCS.
23	3"X8"	FOAM ROLLER	4 PCS.
24		LOCK PIN (pre-installed)	1 PCS.
25		POP PIN (pre-installed)	1 PCS.

Hardware (To Scale)

Part #1 M12X75mm HEX HEAD BOLT QTY. 4

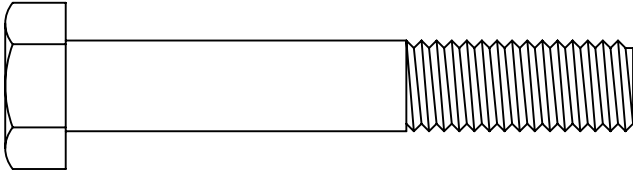

Part #2 M10X15mm ALLEN HEAD BOLT QTY. 4

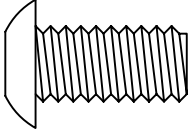

Part #3 M8X45mm HEX HEAD BOLT QTY. 2

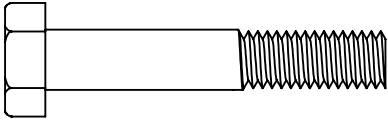

Part #4 1/2"X3" HEX HEAD BOLT QTY. 2

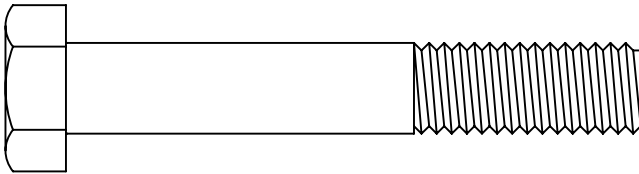

Part #5 5/16"X1" HEX HEAD BOLT QTY. 8

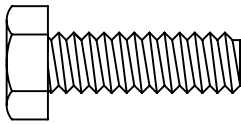

Part #6 M12 NYLON LOCK NUT QTY. 4



Part #7 M8 NYLON LOCK NUT QTY. 2

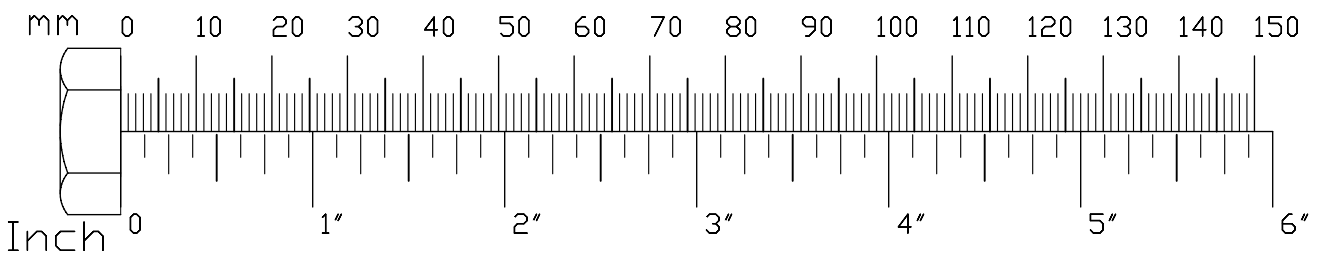
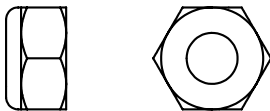

Hardware (To Scale)

Part #8

1/2" NYLON LOCK NUT

QTY. 2

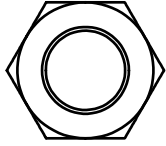
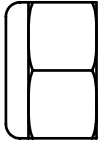

Part #9

M12 WASHER

QTY. 8

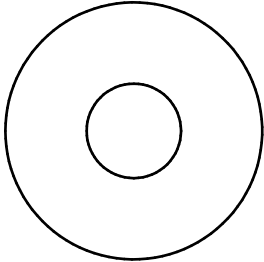

Part #10

M10 WASHER

QTY. 4

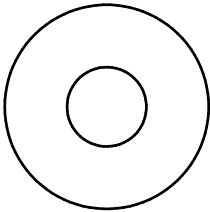

Part #11

M8 WASHER

QTY. 4

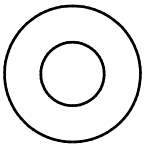

Part #12

1/2" WASHER

QTY. 4

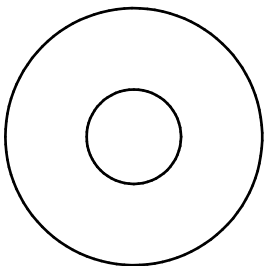

Part #14

5/16" WASHER

QTY. 8

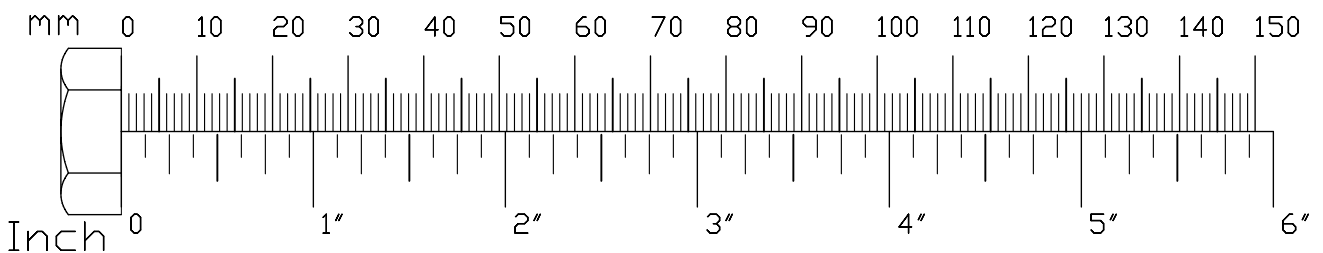
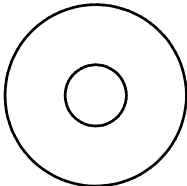

Hardware

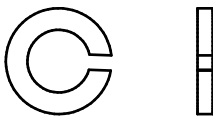
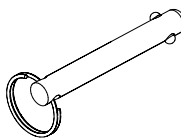
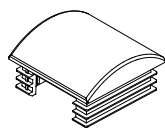
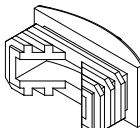
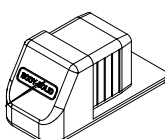
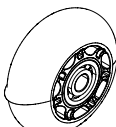
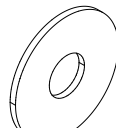
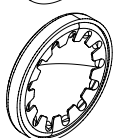
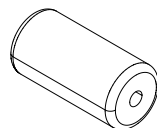
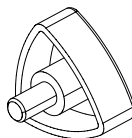
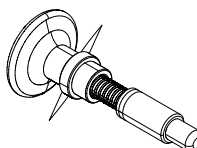
Part #13		5/16" SPRING WASHER	QTY. 8
Part #15		RING PIN	QTY. 1
Part #16		45X45mm END CAP	QTY. 2
Part #17		20X45mm END CAP	QTY. 4
Part #18		1"X2" END CAP	QTY. 1
Part #19		2"X2" FOOT CAP	QTY. 4
Part #20		64mm RUBBER WHEEL	QTY. 2
Part #21		3" NYLON WASHER	QTY. 6
Part #22		1" ROUND END CAP	QTY. 4
Part #23		3"X8" FOAM ROLLER	QTY. 4
Part #24		LOCK PIN (pre-installed)	QTY. 1
Part #25		POP PIN (pre-installed)	QTY. 1

G F I D - 3 1 P a r t s L i s t

PART A -- MAIN FRAME, 1PCS

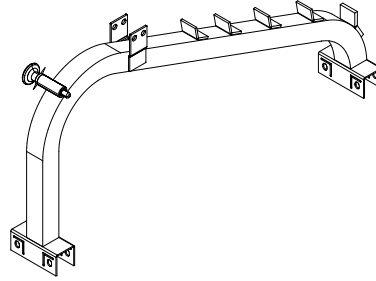

PART B -- BACK FRAME, 1 PCS

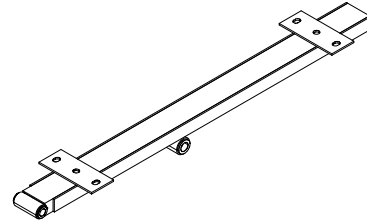

PART C -- REAR FRAME, 1 PCS

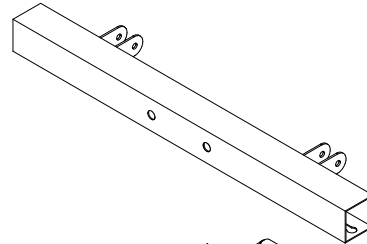

PART D -- LEG FRAME, 1 PCS

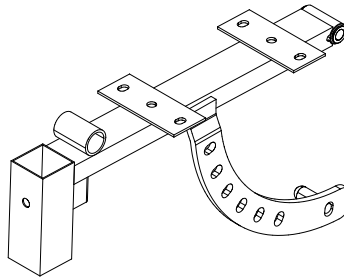

PART E -- HANDLE FRAME, 1 PCS

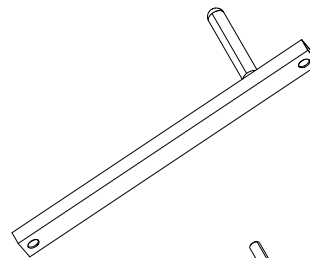

PART F -- INCLINE FRAME, 1 PCS

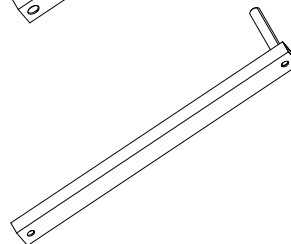

PART G -- PLASTIC SLEEVE, 1PCS

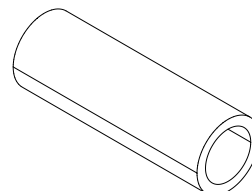

GFID-31 Parts List

PART H -- INCLINE CONNECTOR, 1PCS

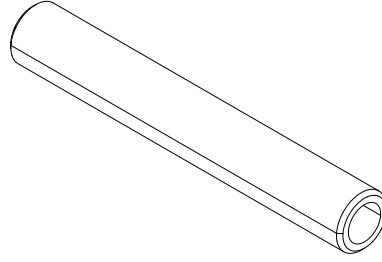

PART I -- FRONT FRAME, 1 PCS

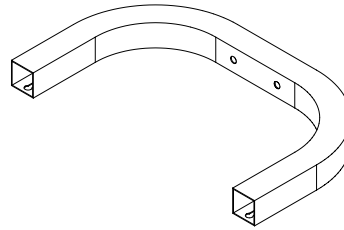

PART J -- LOWER ROD (493mm), 1 PCS

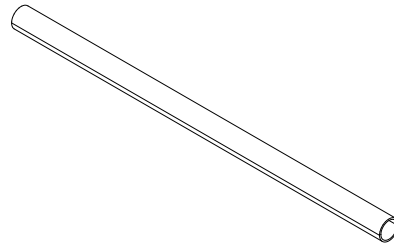

PART K -- LEG ADJUSTER, 1 PCS

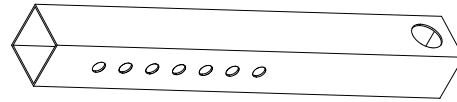

PART L -- UPPER ROD (500mm), 1 PCS

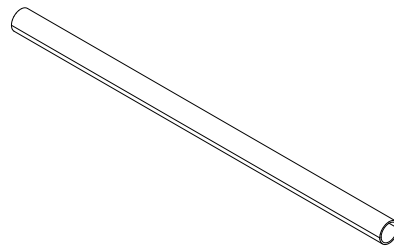

PART M -- BACK PAD, 1 PCS

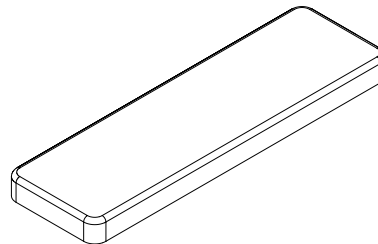

PART N -- SEAT PAD, 1 PCS

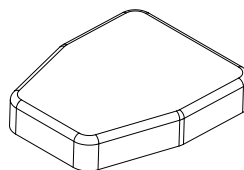

STEP**1**

Be careful to assemble all components in the sequence they are presented.

NOTE:

Finger tighten all hardware in this step. DO NOT wrench tighten until the last step. Some components may be pre-assembled. Nylon lock nuts will not fully screw onto bolts, they must be wrench tighten to fully go on.

- 1A. Attach Front Frame (I) to Mainframe (A) using:
 - 2 - (#1) M12X75mm Hex Head Bolt
 - 4 - (#9) M12 Washer
 - 2 - (#6) M12 Nylon Lock Nut

- 1B. Attach Rear Frame (C) to Mainframe (A) using:
 - 2 - (#1) M12X75mm Hex Head Bolt
 - 4 - (#9) M12 Washer
 - 2 - (#6) M12 Nylon Lock Nut

- 1C. Insert Foot Caps into ends of Front Frame (I) and Rear Frame (C) using:
 - 4 - (#19) 2"X2" Foot Cap

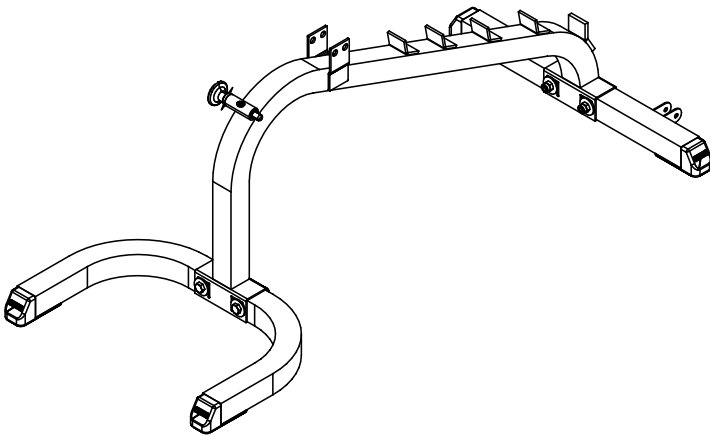

Above shows Step 1 assembled and completed.

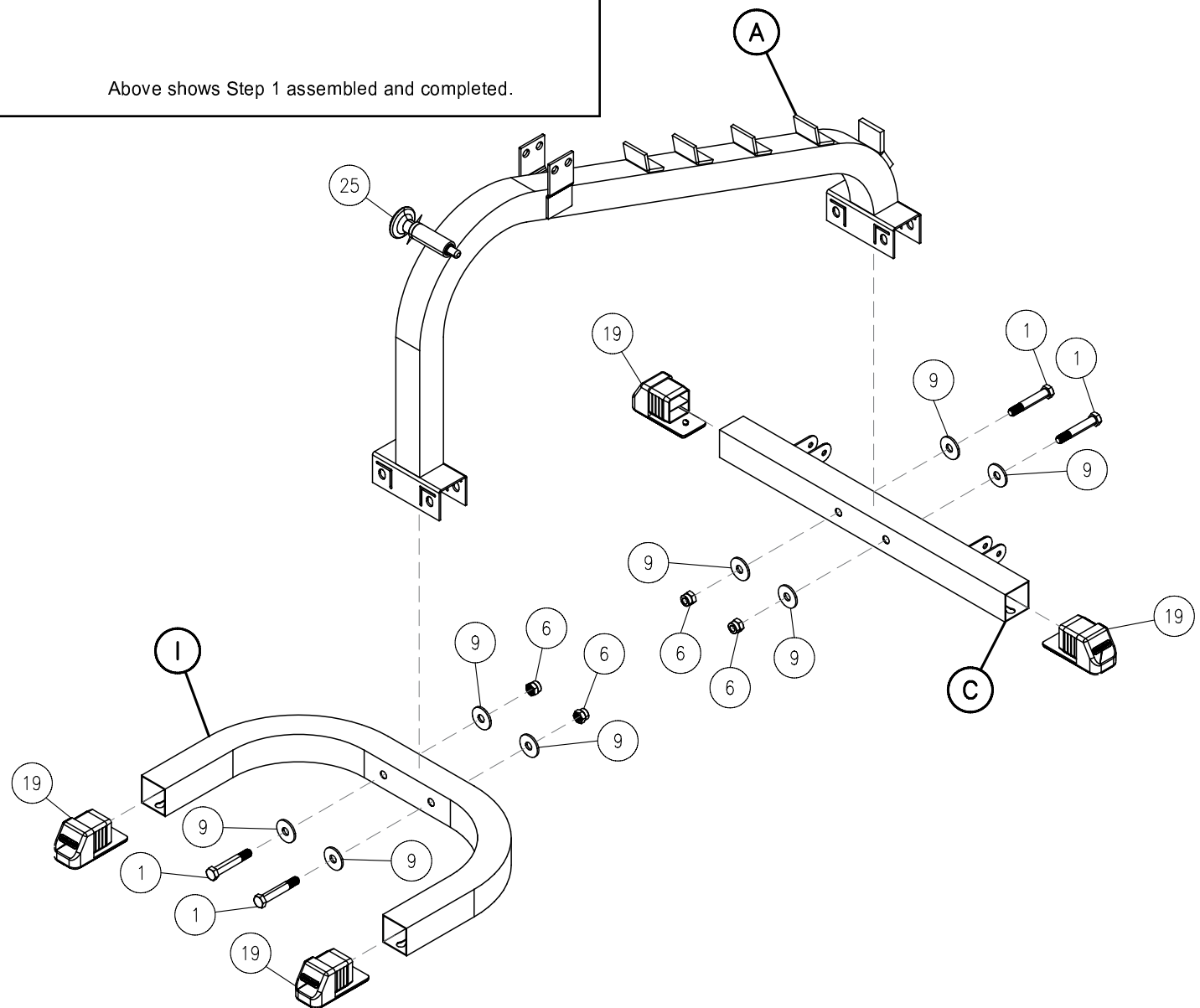

STEP**2**

Be careful to assemble all components in the sequence they are presented.

NOTE:

Finger tighten all hardware in this step. DO NOT wrench tighten until the last step. Some components may be pre-assembled. Nylon lock nuts will not fully screw onto bolts, they must be wrench tighten to fully go on.

- 2A. Attach Seat Pad (**N**) to Leg Frame (**D**) using:
 - 4 - (#5) 5/16"X1" Hex Head Bolt
 - 4 - (#13) 5/16" Spring Washer
 - 4 - (#14) 5/16" Washer

- 2B. Attach Back Pad (**M**) to Back Frame (**B**) using:
 - 4 - (#5) 5/16"X1" Hex Head Bolt
 - 4 - (#13) 5/16" Spring Washer
 - 4 - (#14) 5/16" Washer

- 2C. Insert End Cap into rear end of Back Frame (**B**) using:
 - 1 - (#18) 1"X2" End Cap

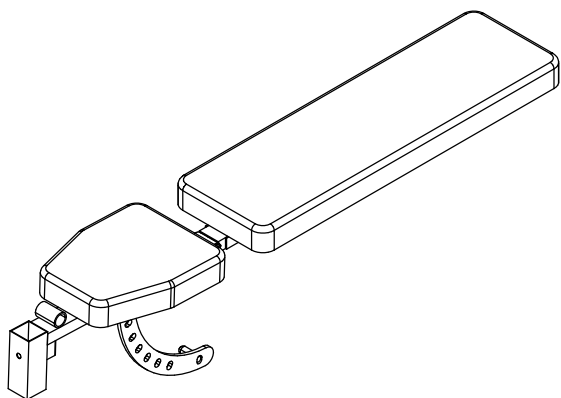

Above shows Step 2 assembled and completed.

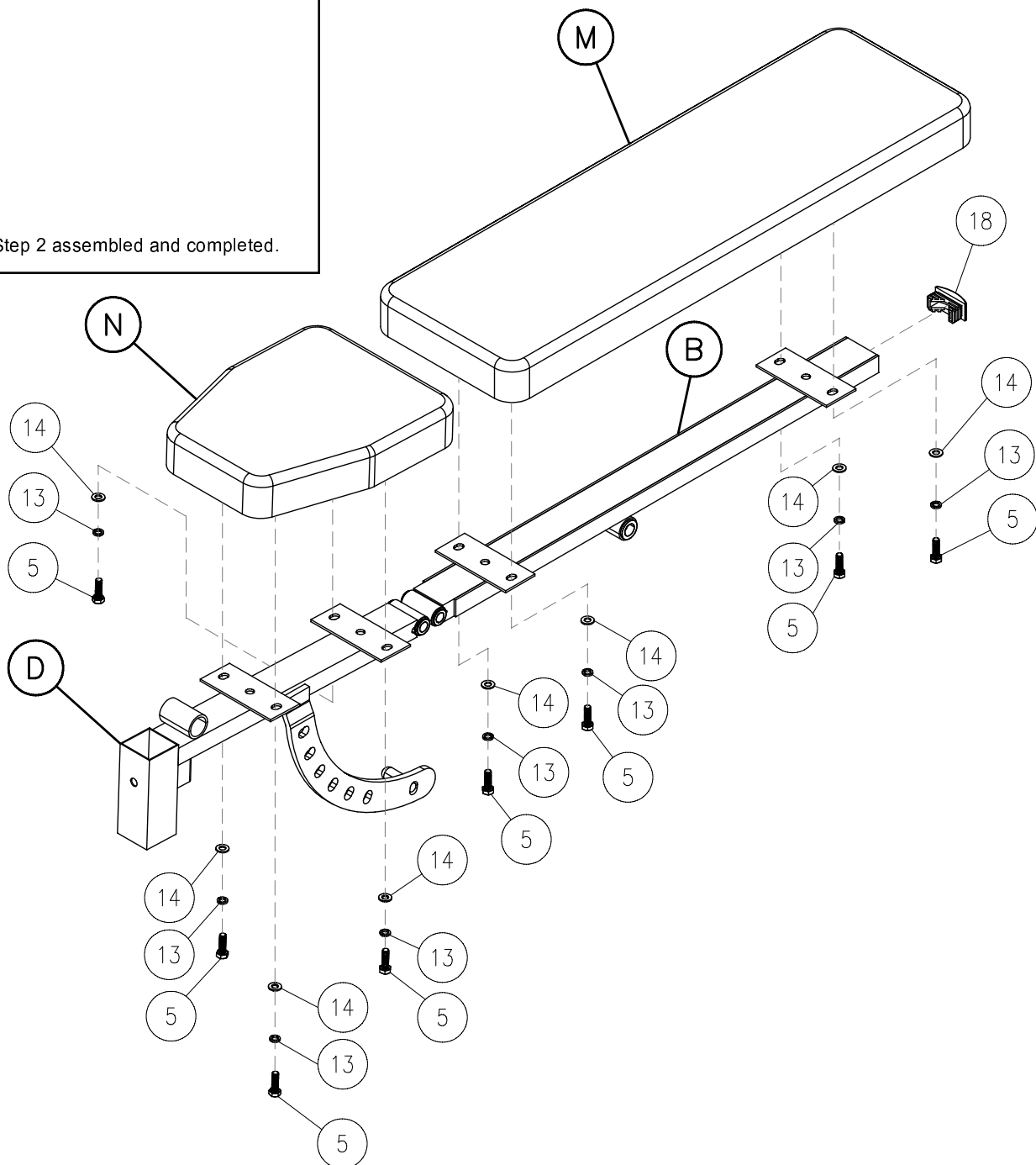

STEP**3****Be careful to assemble all components in the sequence they are presented.****NOTE:**

Finger tighten all hardware in this step. DO NOT wrench tighten until the last step. Some components may be pre-assembled. Nylon lock nuts will not fully screw onto bolts, they must be wrench tighten to fully go on.

Note: Your GFID-31 more than likely will have parts E, H, F, and G already assembled to Back Frame (B) as well as the 20X40mm End Caps (#17). If it is assembled then only follow steps 3D and 3E otherwise follow all the steps. This step also doesn't show the Seat and Back pad to make instructions easier.

- 3A. Insert Plastic Sleeve (**G**) onto the rod of Incline Frame (**F**) and then attach Handle Frame (**E**) to Incline Frame (**F**) using:
 - 2 - (#2) M10X15mm Hex Head Bolt
 - 2 - (#10) M10 Washer

- 3B. Insert Incline Connector (**H**) into the round sleeve located on the bottom of Back Frame (**B**) and then attach both Handle Frame (**E**) and Incline Frame (**F**) to the connector using:
 - 2 - (#2) M10X15mm Hex Head Bolt
 - 2 - (#10) M10 Washer

- 3C. Insert End Caps into the ends of both Incline Frame (**F**) and Handle Frame (**E**) using:
 - 4 - (#17) 20X40mm End Caps

- 3D. Attach Leg Frame (**D**) to Main Frame (**A**) using:
 - 1 - (#4) 1/2"X3" Hex Head Bolt
 - 2 - (#12) 1/2" Washer
 - 1 - (#8) 1/2" Nylon Lock Nut

- 3E. Attach Back Frame (**B**) to Main Frame (**A**) using:
 - 1 - (#4) 1/2"X3" Hex Head Bolt
 - 2 - (#12) 1/2" Washer
 - 1 - (#8) 1/2" Nylon Lock Nut

STEP
3

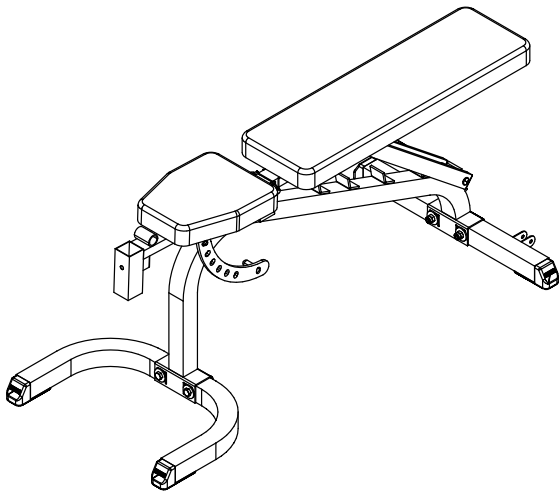

Above shows Step 3 assembled and completed.

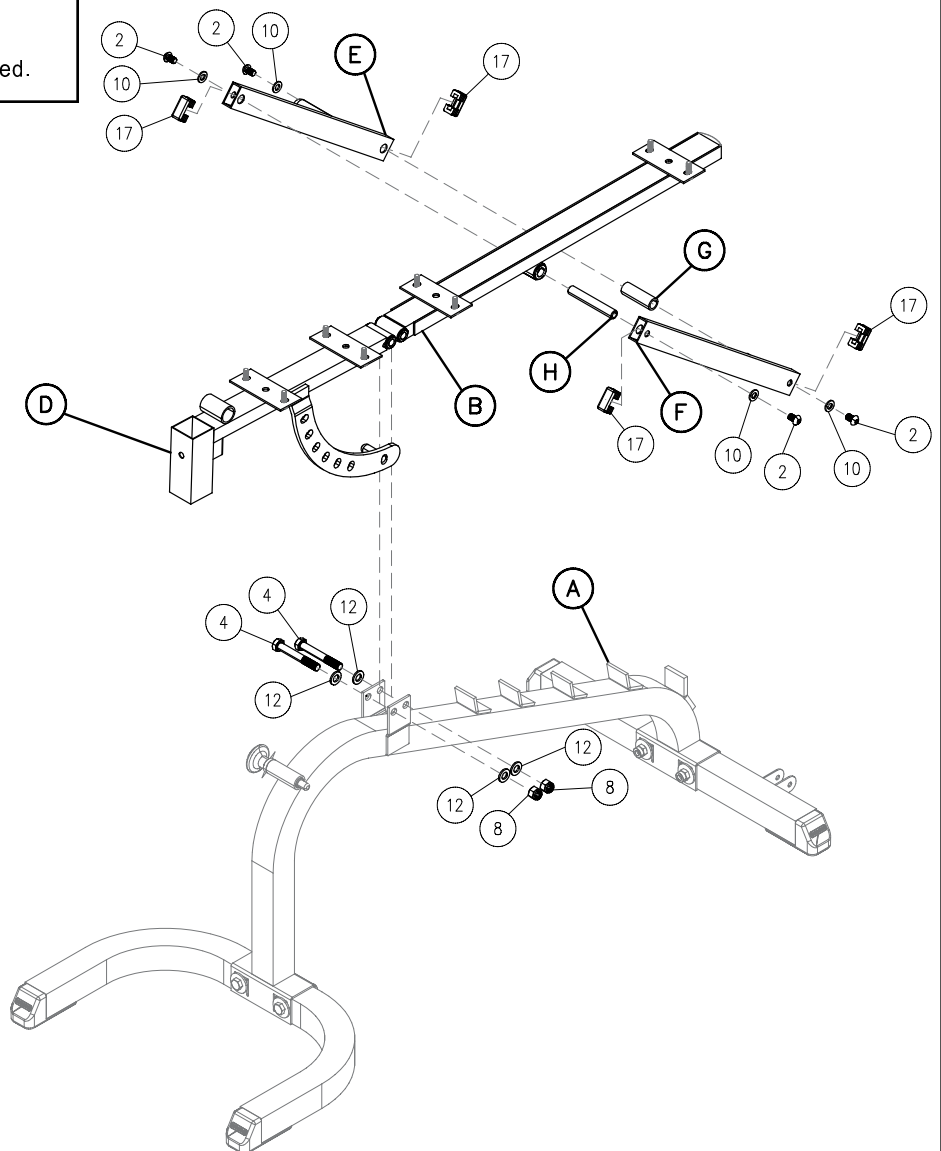

STEP**4**

Be careful to assemble all components in the sequence they are presented.

NOTE:

Wrench tighten all hardware at the end of this step. Some components may be pre-assembled. Nylon lock nuts will not fully screw onto bolts, they must be wrench tighten to fully go on.

- 4A. Insert a End Cap into each end of Leg Adjuster (**K**) using:
2 - (#16) 45X45mm End Cap

- 4B. Insert Lower Rod (**J**) halfway into the larger round opening of Leg Adjuster (**K**). On each end of Lower Rod (**J**) insert a Foam Roller followed by a Nylon Washer and a Round End Cap using a total of:
2 - (#23) 3"X8" Foam Roller
2 - (#21) 3" Nylon Washer
2 - (#22) 1" Round End Cap

- 4C. Insert Upper Rod (**L**) halfway into the round slot on top of Leg Frame (**D**). On each end of Upper Rod (**L**) insert a Foam Roller followed by a Nylon Washer and a Round End Cap using a total of:
2 - (#23) 3"X8" Foam Roller
2 - (#21) 3" Nylon Washer
2 - (#22) 1" Round End Cap

- 4D. Insert Leg Adjuster (**K**) into Leg Frame (**D**) and secure using:
1 - (#15) Ring Pin
1 - (#24) Lock Pin

- 4E. Attach both Rubber Wheels to the rear of Mainframe (**A**) using a total of:
2 - (#20) 64mm Rubber Wheel
2 - (#3) M8X45mm Hex Head Bolt
4 - (#11) M8 Washer
2 - (#7) M8 Nylon Lock Nut

Notes

Exploded View

