

# Hisense

life reimagined

## USER'S OPERATION MANUAL

Before operating this unit, please read this manual thoroughly, and retain for future reference.

**HDF5190H**

**BF5190H\***

**HDF5190H\*2**

**HDF5190H\*3**

EN

English

Thank you very much for choosing our company's products.

- Please correctly install and use this product, and do not use this product to dry items that are not suitable for drying in a clothes dryer.
- The images in the manual are for illustration purposes only. The appearance, printing, etc. shall be subject to the actual product.
- Our company emphasizes technology updates. In order to enhance the overall performance of this appliance, we will make technical changes to it without further notice. Your understanding is appreciated.
- This product is for household use only.

The following symbols in this manual are indicated as follows:

 Information, suggestions, prompts, or advice

 WARNING - GENERAL HAZARD

 WARNING - ELECTRIC SHOCK HAZARD

 WARNING - BURN HAZARD

 WARNING - FIRE HAZARD



Please read the user manual carefully.

# CONTENTS

<b>4 SAFETY PRECAUTIONS</b> .....	<b>INTRODUCTION</b>
<b>13 PRODUCT DESCRIPTION</b> 14 Specifications	
<b>15 INSTALLATION AND CONNECTION</b> 15 Packing/packaging 16 Installation location 16 Adjustable feet 17 Installation clearance 19 Stacking installation 20 Changing the door opening direction 22 Connect the drain hose 23 Drying rack 24 Transportation after installation	<b>PREPARATION BEFORE FIRST USE</b>
<b>25 BEFORE THE FIRST USE</b> 26 Connecting to power mains 28 Programs and functions 29 Program table 31 Additional settings and functions 35 Function selection table 37 Start the program 37 End of the program .....	<b>DRYING STEPS</b>
<b>38 MAINTENANCE AND CLEANING</b> 38 Cleaning the filter 39 Clean the heat exchanger 40 Empty the condensate box 41 Clean the water tank filter 41 Clean the door seal 41 Cleaning the outside of your washer	<b>CLEANING AND MAINTENANCE</b>
<b>42 TROUBLESHOOTING</b> 44 FAULT CODES AND TROUBLESHOOTING <b>45 SERVICING</b> <b>45 USAGE RECOMMENDATIONS</b> .....	<b>TROUBLE- SHOOTING</b>
<b>46 DISPOSAL</b> <b>47 PROGRAM TABLE</b>	<b>MISCELLANE- OUS</b>

# SAFETY PRECAUTIONS



Please read the manual carefully before using this appliance.

Do not use this appliance if you have not read or understood this manual.

This manual is applicable to multiple models. Therefore, this manual is applicable to multiple model.

Failure to follow the instructions or improper operation may damage clothing or the appliance, or cause injury to you. Please place the manual near the appliance for easy access.

**⚠** To reduce the risk of explosion, fire, death, electric shock, injury or scalding to persons when using this product, follow basic precautions, including the following.

- staff kitchen areas in shops, offices and other working environments;
- farm houses;
- by clients in hotels, motels and other residential type environments; bed and breakfast type environments;
- areas for communal use in blocks of flats or in launderettes.

If the appliance is used for professional, for-profit purpose or purpose exceeding normal use in a household and similar applications, or if the appliance is used by a person who is not a consumer, the warranty period shall be equal to the shortest warranty period required by relevant legislation.

This appliance is not intended for use by persons (including children) with reduced physical, sensory or mental capabilities, or lack of experience and knowledge, unless they have been given supervision or instruction concerning use of the appliance by a person responsible for their safety.

Children should be supervised to ensure that they do not play with the appliance.

If the supply cord is damaged, it must be replaced by the manufacturer, its service agent or similarly qualified persons in order to avoid a hazard.

The tumble dryer is not to be used if industrial chemicals have been used for cleaning.

The lint trap has to be cleaned frequently.

The lint must not to be allowed to accumulate around the tumble dryer.

For appliances with ventilation openings in the base, a carpet must not obstruct the openings.

The maximum capacity in some cycles for dry clothes to be used is Dry (9.0kg) .

The recommended maximum capacity may vary among different programs. For best drying results, refer to the "Program Table".

Do not dry unwashed items in the tumble dryer.

Items that have been soiled with substances such as cooking oil, acetone, alcohol, petrol, kerosene, spot removers, turpentine, waxes and wax removers should be washed in hot water with an extra amount of detergent before being dried in the tumble dryer.

Items such as foam rubber (latex foam), shower caps, waterproof textiles, rubber backed articles and clothes or pillows fitted with foam rubber pads should not be dried in the tumble dryer.

Fabric softeners, or similar products, should be used as specified by the fabric softener instructions.

Remove all objects from pockets such as lighters and matches. Fill steam generators only with liquids specified by the manufacturer.

**WARNING:** Never stop a tumble dryer before the end of the drying cycle unless all items are quickly removed and spread out so that the heat is dissipated.

**WARNING:** The appliance must not be supplied through an external switching device, such as a timer, or connected to a circuit that is regularly switched on and off by a utility.

Exhaust air must not be discharged into a flue that is used for exhausting fumes from appliances burning gas or other fuels.

The appliance must not be installed behind a lockable door, a sliding door or a door with a hinge on the opposite side to that of the tumble dryer, in such a way that a full opening of the tumble dryer door is restricted.

That adequate ventilation has to be provided to avoid the back flow of gases into the room from appliances burning other fuels, including open fires.

## **ELECTRICAL SAFETY**

**This appliance complies with relevant safety standards.**

**Before connecting the appliance to the power supply, please wait at least 2 hours to ensure it reaches room temperature.**

**This appliance must be repaired by an authorized service center, and only spare parts recognized by the authorized manufacturer shall be used.**

**Any repairs and maintenance related to safety or performance should be conducted by trained professionals.**

**Do not attempt to repair this appliance yourself. Repairs by unprofessional personnel may cause personal injury or more serious malfunctions. Please consult your local service center and always use original spare parts.**

Before connecting the appliance to the power supply, ensure that the electric voltage specified on the rating plate matches the Voltage of your socket.

Do not attempt to operate the appliance if it is damaged, malfunctioning, partially disassembled, or has missing or damaged parts, including damaged wires or plugs.

Do not bend the power cord excessively or place heavy objects on it. Ensure that the mains cable is not kinked or trapped, and it does not come into contact with heat sources or sharp edges.

Do not use multiple outlets, extended power cords, or dual adapters on the appliance. Do not use an extended cord to connect the appliance to the power supply.

Do not spray cleaning solution inside or outside the appliance.

In case of flooding, please disconnect the power plug and contact the after-sales service center.

Do not connect the appliance to the electrical socket of an electric shaver or hair dryer.

Do not connect the appliance to an electrical outlet specifically designed for low-load appliances.

This appliance must be earthed via the power cord. In the event of malfunction or breakdown, grounding will reduce the risk of electric shock by providing a path of least resistance for electric current.

Improper connection of the equipment-grounding conductor can result in risk of electric shock. Check with a qualified electrician or service personnel if you are in doubt as to whether the appliance is properly grounded.

This appliance is equipped with a power cord having an equipment-grounding earthing pin and a grounding power plug. The power plug must be plugged into an appropriate outlet socket that is installed and grounded in accordance with all local codes and ordinances.

## **INSTALLATION**

Before using the appliance, be sure to remove the packaging (sponge, polystyrene foam, etc.) attached to the bottom of the appliance.

Please install the appliance correctly according to the instructions and connect the water and electricity (see "INSTALLATION AND CONNECTION").

The connection of water and electricity should be carried out by fully trained technicians or professionals.

Installing a dryer on top of a washing machine at least requires two people.

Do not install this appliance in places where door opening is restricted.

Always use the pipe or hose provided with the appliance.

The appliance may not be in contact with a wall or adjacent furniture.

Please install the appliance in a room with adequate ventilation and a temperature between 10°C and 25°C. **Do not install the appliance in an area where the temperature may drop to 5°C below, otherwise, the parts may be damaged when water freezes.**

Place the appliance on a sturdy flat surface. If the appliance is installed on a high platform, it must be secured to prevent it from tipping over.

Keep the bottom and surrounding area of the appliance free of flammable materials such as threads, paper, rags, chemicals, etc.

This appliance must not be stored or used in any outdoor locations.

Avoid lint accumulation near the appliance. For appliance with vents at the bottom, please ensure that the vents are not blocked by carpet.

**Do not block the air outlet**, and do not place the appliance on a long-fiber carpet to avoid obstructing air circulation.

Do not install the appliance near heaters or any flammable items.

Do not install the appliance in places where gas leakage may occur or where the air contains dust particles.

Please ensure good ventilation conditions to avoid the gas generated by this appliance from flowing back into the room, thereby causing a fire.

## USAGE

After the installation is complete, please let the appliance stand for 24 hours before using it. If the appliance needs to be laid down during transportation or maintenance, please face the appliance and tilt it to the left side horizontally.

**Inspect the appliance to see if it has been damaged during transportation. Never operate the appliance in a damaged condition.**

The dryer uses a heat pump system to heat the air.

If the condensate tube is blocked or clogged, then tumble dryer operation is stopped.

When cleaning the filters, the lint should be thrown in the garbage bin and not washed through the drain in order to avoid spreading microplastics in the used water system.

Do not use wet hands to touch the power plug or operate the appliance.

The system consists of a compressor and a heat exchanger. When the dryer is started, compressor operation (the sound of flowing liquid) or flow of refrigerant may be louder as long as the compressor operates. This is not a sign of malfunction and it will not affect useful life of the dryer. In time and with use of the dryer this noise will become quieter.

Do not drink or prepare food with the condensed water/ distilled water. It can cause health problems to people and pets.

Never attempt to operate the appliance if it is damaged, malfunctioning, partially disassembled, or has missing or broken parts, including a damaged cord or plug.

### **BURN HAZARD**

If you open the dryer door during the drying process, the clothes may be very hot and there is a risk of burning.

### **FIRE HAZARD**

This appliance is only for drying clothes washed with water. Do not dry clothes washed or cleaned with industrial cleaners, chemicals, flammable cleaners, or similar substances (such as gasoline, trichloroethylene, etc.); otherwise, it may cause an explosion.

Do not attempt to separate any panels or disassemble the appliance.

Do not use sharp objects like pins, knives, or fingernails to press the button.

**After the program is finished, unplug the power plug.** Never unplug an appliance by pulling on the power cord. Always firmly grasp the power plug and pull it directly out from the socket.

Because the appliance is heavy, you may injure yourself trying to lift it. Do not lift the appliance yourself; your hands may be cut by its sharp edges.

Do not grasp the appliance by its protruding parts. The protruding parts on the appliance may break when lifting or pushing the appliance.

Do not dry clothes with large buttons or other heavy metal items. Make sure all pockets of clothes to be dried are empty. To prevent odors and mold, leave the door open and let the drum air dry after the drying cycle.

Do not leave metal objects in the drum for a long time.

The door glass may break due to strong impact, so be careful when using the appliance.

Please put the clothes completely into the drum so that the clothes do not get caught in the door.

Unplug the power cord from the electrical outlet when the appliance is not in use.

Do not put animals (such as pets) into the appliance.

Oil-affected items can ignite spontaneously, especially when exposed to heat sources such as in a tumble dryer. The items become warm, causing an oxidation reaction in the oil. Oxidation creates heat. If the heat cannot escape, the items can become hot enough to catch fire. Piling, stacking or storing oil-affected items can prevent heat from escaping and so create a fire hazard.

If it is unavoidable that fabrics that contain vegetable or cooking oil or have been contaminated by hair care products be placed in a tumble dryer they should first be washed in hot water with extra detergent - this will reduce, but not eliminate the hazard.

Do not use any solvents or cleaning agents that may damage the appliance (please refer to the recommendations and instructions of the relevant cleaning agent manufacturer).

Do not use this appliance to dry unwashed clothing (except for certain drying care programs).

## **BURN HAZARD**

During the drying process, the door may become hot. Be careful to avoid burns. Do not let children play near the door. Do not touch the door glass during the operation of the appliance.

The back of the appliance may become very hot during operation. Do not touch the back of the appliance until it has completely cooled down.

Do not turn off the power during the drying process. After drying, please take out the clothes immediately to avoid leaving them in the appliance for a long time to prevent fire. After taking them out, please hang or lay them flat as soon as possible and let them cool naturally.

The dryer is protected with an automatic switch-off system in case of overheating. This system will switch off the dryer if the temperature is too high.

Never reach into the appliance while it is operating. Wait until the drum has completely stopped.

Do not push down on the door, when the appliance door is open.

If the net filter is clogged, the overheating automatic switch-off system may be activated. Clean the filter, wait for the dryer to cool down, and try running it again. If the dryer still fails to start, call a service technician.

## **WARNING**

In the appliance enclosure or in the built-in structure, keep ventilation openings clear of obstruction.

## **WARNING**

The appliance contains refrigerant which although it is environmentally friendly, is flammable R290. Failure to dispose of it properly may result in a fire or poisoning. Dispose of the appliance properly and do not damage the pipes in the refrigerant circuit.

Always ensure that the condensate tank is drained before moving the appliance or storing it in an unheated room during the winter.

## **WARNING**

Do not damage the refrigerant circuit.

## **CHILD SAFETY**

Before you close the appliance door and run the program, please ensure that there is only clothing in the drum. Make sure that no children climb into the appliance and close the door from the inside.

Do not let the appliance door stay open. Children may hang on the door or climb inside the appliance, causing damage or injury.

Keep all packaging materials in a place out of the reach of children, as these may be dangerous.

**Do not let children under 3 years old approach the appliance if they are not supervised at all times.**

After understanding the safe use of the appliance and the dangers caused by improper use, children aged 8 years and above, as well as people with reduced physical, sensory, or mental abilities, or lack of experience and knowledge, can use this appliance, but they need to be supervised.

Children must not clean the appliance or perform any maintenance on it without supervision.

## **SERVICING**

The user shall be responsible for the repair costs of damage caused by improper connection, improper installation and use, or repair by unauthorized personnel, as such damage is not included in the warranty.

**The warranty does not include** consumables, slight color deviations, increased noise due to appliance aging (which does not affect the functionality of the appliance), and cosmetic defects of parts (which do not affect the functionality and safety of the appliance).

# PRODUCT DESCRIPTION

## Front

- 1 Condensate box
- 2 Knob
- 3 Control panel
- 4 Door
- 5 Filter
- 6 Air vent
- 7 Heat exchanger door cover

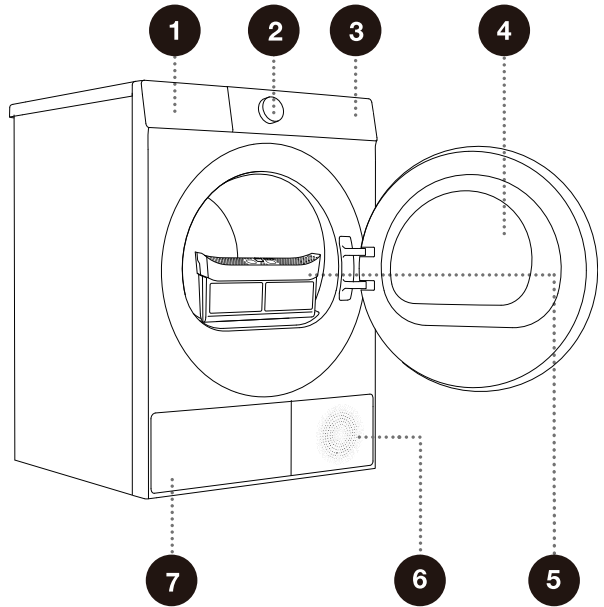

## Back

- 1 Power cord
- 2 Condensate discharge hose
- 3 Adjustable feet

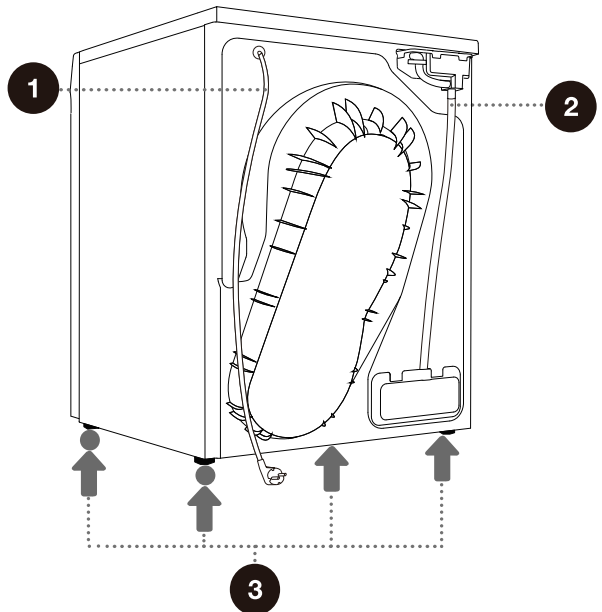

 The illustrations in this manual are for demonstration purposes only. Due to product improvements and series expansion, the product appearance, color, and functional components you receive may differ from the illustrations in this manual. Please refer to the actual product.

# SPECIFICATIONS

(depending on the model)

Maximum load	9.0kg
Net weight	47kg
Rated voltage	220-240V~
Rated frequency	50Hz
Rated power	600W
Refrigerant type	R290
Refrigerant capacity	110g

## DIMENSIONS (MM)

Index	Dimensions (mm)
A	595
B	845
C	565
D	590
E	620
F	1110

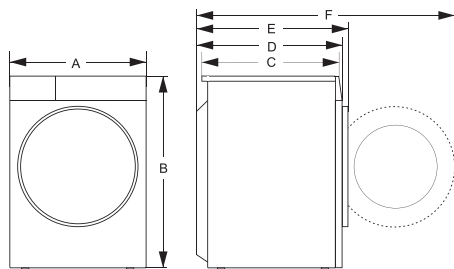

# INSTALLATION AND CONNECTION

## PACKING/PACKAGING

-💡- Please first remove all the packaging and foam, especially the foam base. When unpacking the device, please do not use sharp objects to damage it. Keep packaging materials (plastic bags, other plastic parts, etc.) out of reach of children.

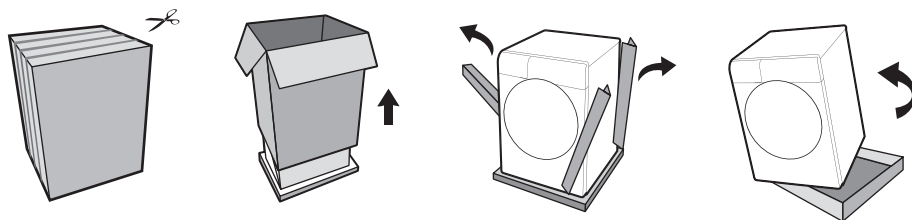

-💡- The process of packing the machine is just the opposite of unpacking above.

-💡- Please check the device for any damage. If damaged, do not use it, and immediately contact after-sales service.

The accessories included with this appliance include one or more of the following:



Instructions

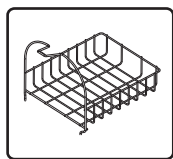

Drying rack

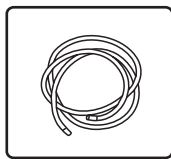

Drain pipe

-💡- Different models have different configurations, and the included accessories are subject to the actual configuration of the model.

-💡- For your safety and extended product life, use only authorized components. The manufacturer is not responsible for product malfunction or accidents caused by the use of unauthorized components or parts.

# INSTALLATION LOCATION

💡 Please place the appliance on a solid surface and keep it steady. The flat surface should be kept clean and dry; otherwise, the appliance may slip. Also, clean the bottom of the adjustable feet.

## ADJUSTABLE FEET

Use a level and a 22 mm wrench for adjustment.

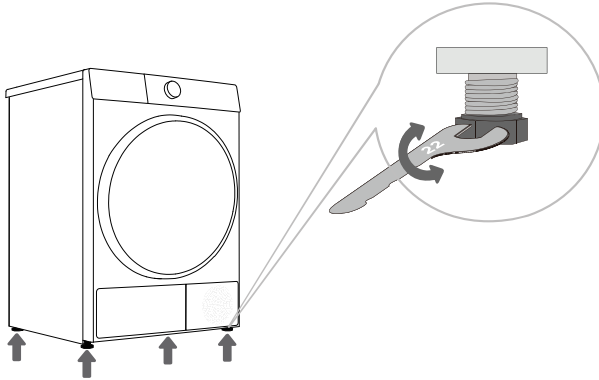

---

**1** Level the appliance by turning the four adjustable feet. The adjustable feet allow 1 cm height adjustment.

---

**2** After adjusting the height, use a wrench to tighten the lock nut by rotating it counterclockwise (see figure).

💡 Incorrect levelling of the dryer with the adjustable legs may cause vibration, appliance sliding across the room, and loud operation. Incorrect levelling of the dryer shall not be subject to warranty.

💡 Sometimes, unusual or louder noise may appear during appliance operation; these are mostly the result of improper installation.

# INSTALLATION CLEARANCE

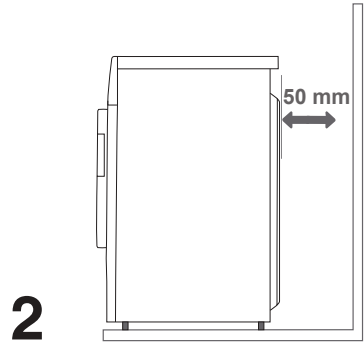
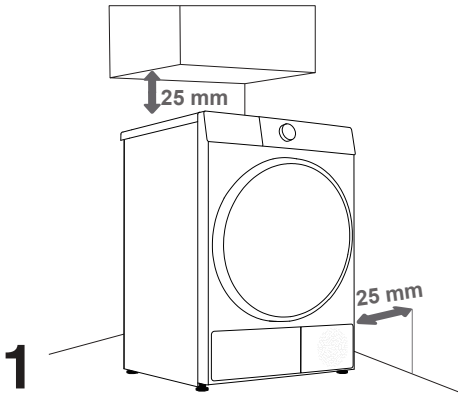



 The dryer may not be in contact with a wall or adjacent furniture. For optimum dryer operation, we recommend observing the clearance from the walls as indicated in the figure. In case of failure to heed the required minimum clearance, the dryer may overheat.

 Vents on the back wall and the air exhaust opening on the front side of the dryer should never be obstructed.

 The room in which you will install the dryer should be sufficiently ventilated, with a temperature between 10°C and 25°C. Dryer operation at a lower environment temperature may result in condensate accumulation in the dryer interior. Do not place the dryer into a place where there is danger of freezing. Frozen water in the condensate tank and pump may damage the dryer.

 The dryer emits heat. Therefore, do not place it in a very small room, as the drying process may take longer due to limited amount of available air.

 Lighting in the room should be sufficient to allow reading the information on the display unit on the control panel.

 Do not place the dryer behind lockable or sliding door, or door with a hinge on the opposite side of the dryer door hinge. Install the dryer in such way that the door can always be freely opened.

 Do not place the dryer on a carpet with long fibres as this may impede air circulation.

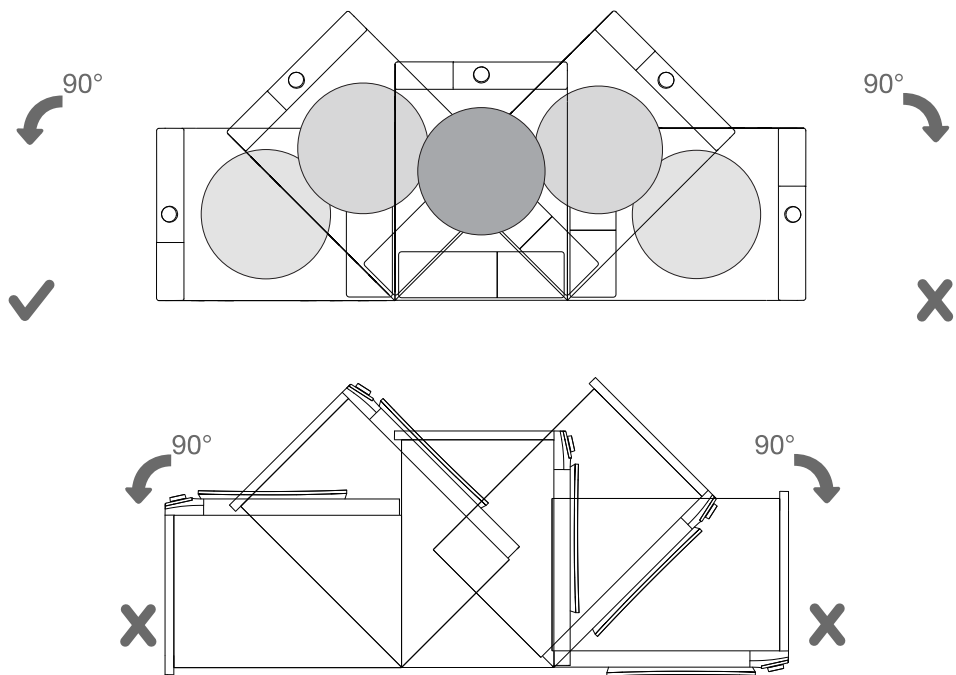

💡 After installation, wait for 24 hours without moving the appliance before using it for the first time. If the dryer has to be laid down on one of the sides during transport or servicing, place it with its left side, viewing from the appliance front, downwards.

# STACKING INSTALLATION

This dryer must be stacked with a washing machine of the same brand using a stacking kit of the same brand (see Figure 1). You can contact local dealer for purchase figure a, and install it according to user manual.

Alternatively, the dryer can be placed next to the washing machine (figure 2).

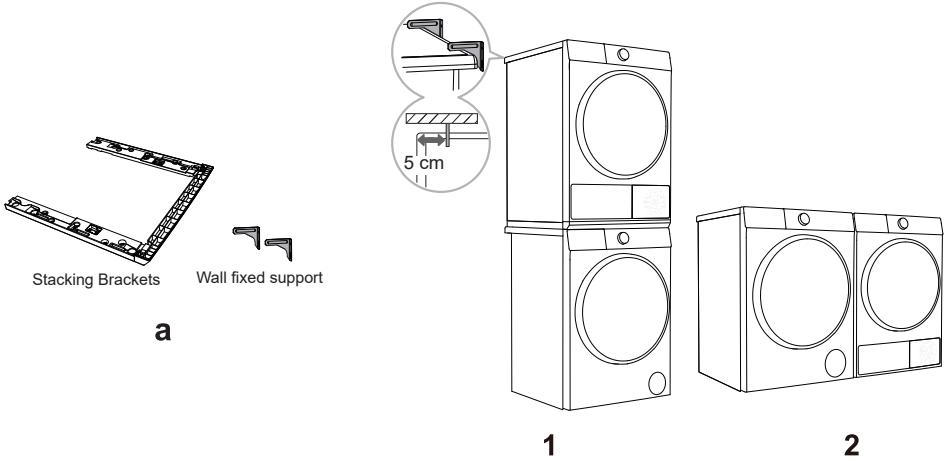

## STACKING BRACKETS (ACCESSORIES)

Please use original accessories. You can refer to the following recommendations for purchasing stacking brackets.

Dryer series	Dryer depth(D)	Washing machine series	Washing machine depth(D)	Matching Stacking Brackets
3I	590mm	3I	510/550/590mm	HPSS5I

 At least two persons are required to install the tumble dryer on top of a washing machine.

# CHANGING THE DOOR OPENING DIRECTION

For easier operation, you can change the door opening direction. The steps are as follows (taking the example of changing from opening the door from the left side to opening the door from the right side).

## WARNING

Support the door with a stool or box that fits under the door, or have an assistant support the weight of the door.

Avoid dropping the door.

Unplug the appliance or turn off power at the main circuit breaker before beginning door reversal.

Always reverse the door BEFORE stacking the appliance on top of the washer.

Do not reverse the door while the appliance is stacked on a washing machine.

Before removing the hinge screws, have an assistant support the weight of the door. The door could fall on the floor due to the weight of the door.

For safety reasons, two or more people need to work together to reverse the door.

The appearance of the screws varies and the screws must be inserted differently depending on the position. Make sure that you've selected the correct screw before tightening.

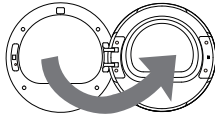

---

**1** Fully open the door.

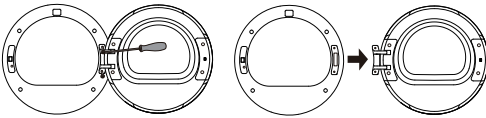

---

**2** Unscrew the two fastening screws of the door hinge with a phillips screwdriver (or 8 mm socket spanner) to remove the whole door body.

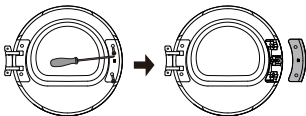

---

**3** Unscrew the two screws of the door hook cover plate with a phillips screwdriver, and remove the whole door hook cover plate (including the door hook).

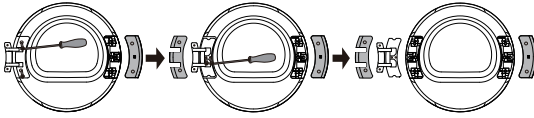

**4** Unscrew the two screws of the hinge cover plate, pull it out horizontally with a little force, and then remove the two screws (stainless steel pan head screws) on the reinforcing iron plate. And press the door body with one hand, grasp the hinge with the other hand, lift it up little by little, and slowly remove the hinge from the positioning pin. If necessary, use a flat head screwdriver to pry it.

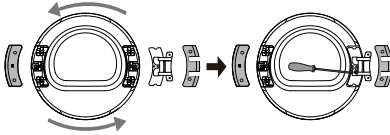

**5** Rotate the hinge assembly 180° to the other side, install the hinge assembly on the stud and press it tightly, and then tighten the two screws in the middle.

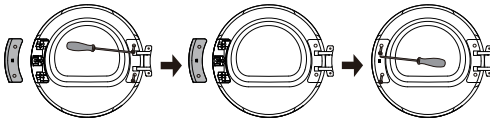

**6** Rotate the hinge cover plate and the door hook cover plate 180° respectively and install them at the corresponding positions on the other side of the inner frame, and then tighten the screws.

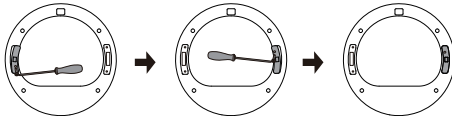

**7** Remove the door lock screw of front assembly pull down the door lock vertically by hand, take it down and rotate it 180° to the other side. Then install it to the hole of front assembly, pull it down to clamp it, and tighten the screws. Now, the reversing of door lock is completed.

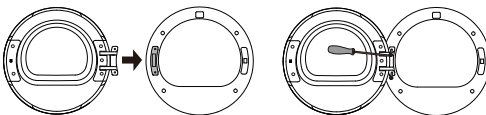

**8** Finally, install the door hinge on the front assembly, tighten the two screws, and close the door. At present, the door reversing (from left opening to right opening) is completed.

# CONNECT THE DRAIN HOSE

If the appliance is not connected to a drain hose, the water extracted from the clothes by the condenser will accumulate in the condensate box, which needs to be emptied after each program. If the installation location of the appliance is close to the drain outlet, or if the dryer is stacked on top of the washing machine, you can install the drain hose included in the package to drain the water directly into the drain outlet.

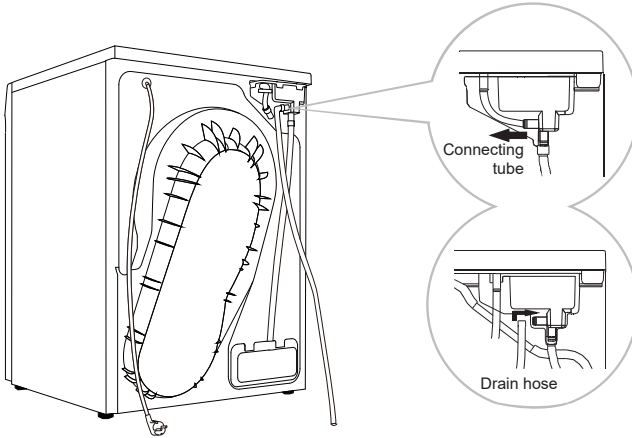

**1** Unplug the connecting tube at the back of the appliance's condensate box and hang it on the back of the appliance.

**2** Install the drain hose in the accessories to this position (as shown in the figure), please confirm that the installation connector is firmly inserted, and insert the other end of the drain hose into the drain outlet.

 If you decide to place the condensate drain hose into the drain outlet, make sure the drain hose is installed correctly. After the drain hose is installed in place, the condensate water can be discharged directly, without the need to empty the condensate box after each use.

 Please use the drain hose provided with this appliance.

 Do not twist or compress the drain hose, otherwise it will affect normal drainage. The height of the drain hose must not exceed the height of the machine body; otherwise, the water cannot be drained. If the drain hose is too long, please cut off the excess portion.

 Do not place the drain outlet in stagnant water; this may cause backflow.

# DRYING RACK (AVAILABLE ON SELECT MODELS)

Before the first drying cycle, remove the drying rack and all packaging materials from the drum. When using the drying rack for special garments, install it as follows.

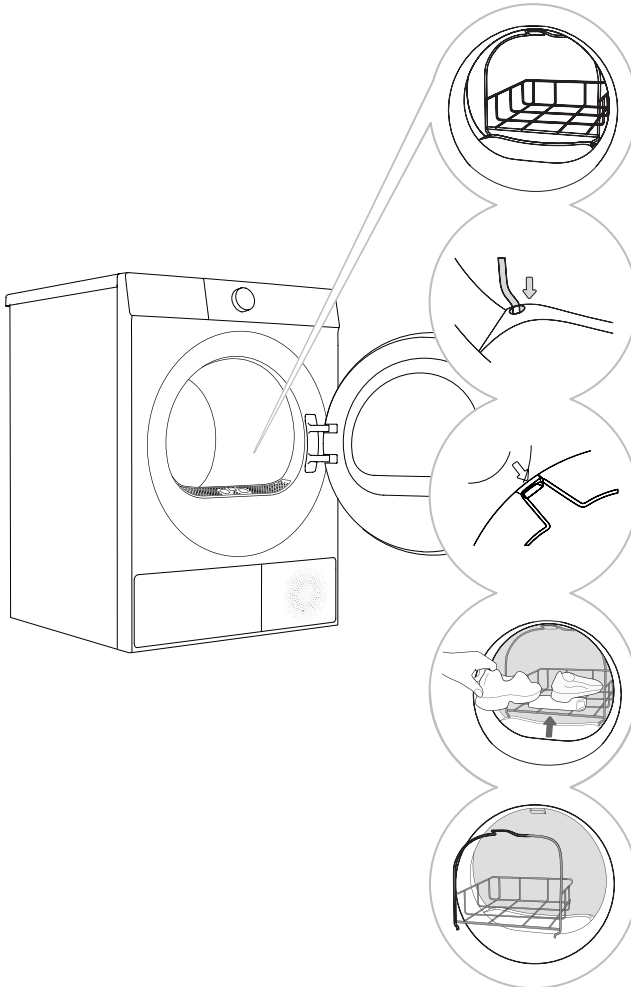



**1** Open the door and insert the drying rack.

**2** Tilt the drying rack at an angle, securing the lower end into the two holes of the filter and hooking the top end onto the slot of the front support (as shown).

**3** The drying rack can be used for sports shoes, slippers, or other items unsuitable for tumbling.

**4** After drying is complete, remove the drying rack and close the door.

 Before drying, sports shoes or slippers should be wrung out to prevent dripping.

 The drying rack remains stationary during drum rotation. Therefore, ensure items on the drying rack do not contact the drum. Otherwise, garments and the dryer may be damaged.

# TRANSPORTATION AFTER INSTALLATION

If you need to transport an installed appliance, first unplug the power plug, detach the drain hose, and ensure the door is closed properly.

After each drying program, a small amount of condensation may remain in the appliance. Start the appliance, select any program, and run it for about half a minute to drain the accumulated water to prevent damage to the appliance during transportation. If it is not possible to transport the appliance upright, please tilt it to the left.

Pack all packaging materials (plastic bags, other plastic parts, etc.).

 The device is heavy. Please use at least two people to move it. When transporting, do not hold protruding parts such as the door, top cover, etc., to prevent them from falling off or being damaged.

 After transport, let the device sit for at least 2 hours before connecting it to the power supply. The device should be installed and connected by trained technicians.

 Please read the instructions carefully before reconnecting the device. Damage caused by improper connection or use is not covered by the warranty.

 If the appliance was not transported according to the instructions, it should be allowed to rest for at least 24 hours before connecting it to the power supply. Failure to do so may lead to heat pump failure, and such failures are not covered by the warranty. Be careful not to damage the cooling system; please refer to "Installation and connection".

## Transport and Handling Method

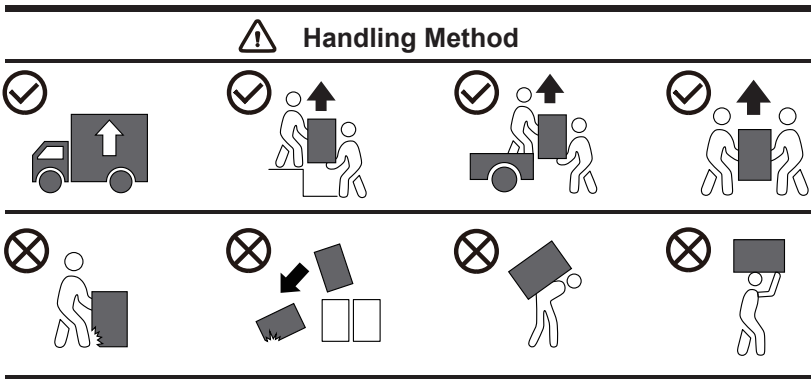



























# BEFORE USING THE APPLIANCE FOR THE FIRST TIME

## THE FIRST USE

Before using this product for the first time, please ensure that the appliance is not connected to the power supply. Then, open the door and clean the drum with a soft damp cloth.

 Do not use solvents or cleaning agents that may damage the appliance (please follow the recommendations and warnings provided by the cleaning agent manufacturer).

Washing	Maximum water temperature 95°C  	Maximum water temperature 60°C  	Maximum water temperature 40°C  	Maximum water temperature 30°C  	Hand wash only 	Do not wash 
Rinsing	Rinse in cold water 			Do not rinse 		
Dry cleaning	It can be dry cleaned. No restrictions on detergent. 	Dry clean with petroleum solvents R11 and R113. 	Dry clean with kerosene, pure alcohol, and R113. 	Do not dry clean 		
Ironing	Maximum ironing temperature 200°C 	Maximum ironing temperature 150°C 	Maximum ironing temperature 110°C 	Do not iron 		
Drying	Dry flat (placed on a flat surface) 	Drip dry  Line dry 	High heat  Low heat 	Do not dry 		

## PREPARATION FOR DRYING

1. Classify clothing according to its type and thickness, and refer to the requirements on the clothing labels.
2. Empty all pockets. Remove metal items that could damage clothing or the appliance. Fasten buttons and turn garments with buttons or embroidery inside out. Zip up and tie any drawstrings.
3. Place sensitive clothing and small, lightweight clothing into a dedicated mesh laundry bag and dry them with other clothing.
4. For clothing with pilling surfaces or long pile fabrics, please turn them over before drying.
5. It is not recommended to use a dryer to dry delicate fabrics, as they may be damaged during drying. To avoid damage, please do not put the following types of clothing into the dryer:
  - Leather clothing and other leather products.
  - Clothing that has undergone waxing treatment or requires special care.
  - Clothing with a large amount of wool, plastic, or metal decoration.
  - Clothing with sequins.
  - Clothing with metal accessories that are prone to rusting.

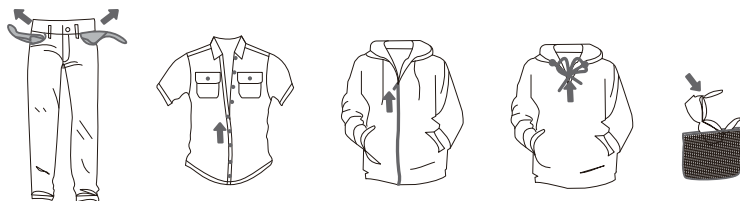

# CONNECTING TO POWER MAINS

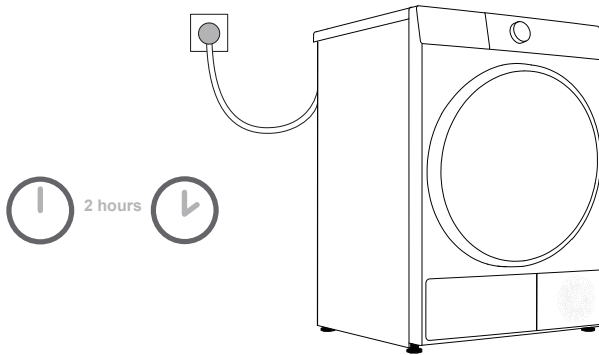

 **After installation, the appliance must remain on a stable surface for at least 2 hours before connecting to the power supply.**

This appliance is connected to a grounded power socket, and there should be no obstructions between the appliance and the socket. The power socket should have compliant grounding protection. Ensure that the power supply is consistent with the power requirements of the appliance. For basic information about the appliance, please refer to the nameplate.

 **It is recommended to use overvoltage protection devices to protect this appliance from lightning strikes.**

 Do not use an extension cord to connect the appliance to the power supply.

 Do not connect the appliance to a power outlet designated for light-load appliances.

 Please do not plug or unplug the appliance with wet hands.

 The repair and maintenance of this appliance should be handled by professionally trained personnel.

 Only personnel authorized by the manufacturer can replace a damaged power cord.

# PUT IN THE CLOTHES TO BE DRIED

Open the machine door, confirm there is no foreign matter in the drum, and loosely place the clothes into the drum.

Close the door until you hear a "click" indicating it is securely closed.

⚠ Do not overload the drum! Refer to the "PROGRAM TABLE" for the maximum load. If the drum is too full, the clothes will be more wrinkled and may not dry effectively.

⚠ Please completely put the clothes into the drum to prevent the clothes from getting caught in the door.

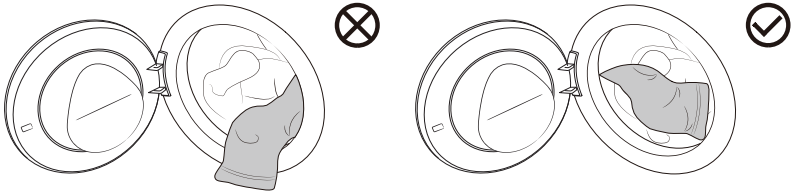

⚠ While the dryer is operating, you can easily open the door to add or remove clothes. After closing the door, press the Start/Pause button to resume operation.

⚠ Do not put clothing into a dryer without wringing or spinning it (recommended minimum drying speed of 800 RPM).

⚠ When drying larger items (bedding, quilts, etc.), be sure to shake out the clothing before placing it in the dryer.

# PROGRAMS AND FUNCTIONS

## CONTROL PANEL

Please refer to the actual product for the final print

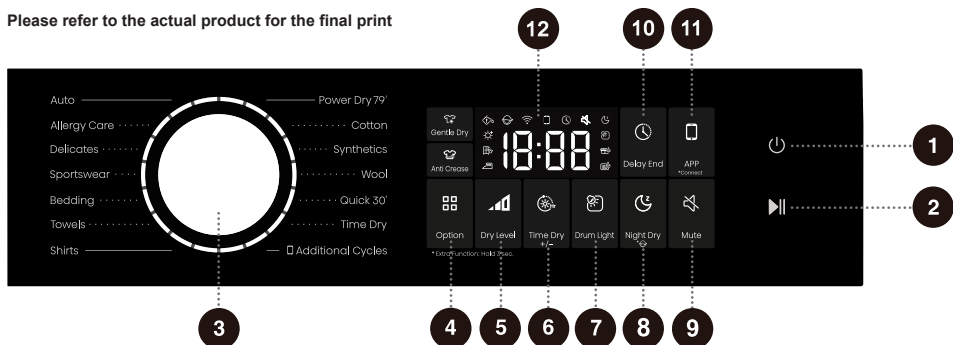

### 1 Power

Used to turn on/off the device power.

### 2 Start/Pause

Used to start/pause a program.

### 3 Cycle Selector

Turn the knob to select the program.

### 4 Options

Press this button to select additional functions for the program.

### 5 Dry Level

This function selects the drying effect of the program.

### 6 Time Dry +/-

The function adjusts the drying time of the program.

### 7 Drum Light

The function manually turns the Drum Light on/off.

### 8 Night Dry

Press to turn the Night Dry function on/off.



Long-press turns the Child Lock function on/off.

### 9 Mute

Press this button to turn the mute function on or off.

### 10 Delay End

This function allows you to schedule drying clothes at your convenience.

### 8 APP

Short press to turn on/off the device's APP remote control.

#### \* Connect

Long press to turn on/off the Wi-Fi function of the device.

### 12 Display

Used to display the remaining time of the program, reservation time, fault code, and other related information.

**\*Extra Function: Hold 3 sec.**

For extra function:  
Press and hold for 3 seconds.

# PROGRAM TABLE

Turn on the device and turn the main knob to select the appropriate program (depending on the type of clothing and desired degree of drying). During operation, the main knob will not turn automatically.

Program	Program description	Maximum load	Drying Type	
			Stop when the clothes are dry	Timed dry
<b>Power Dry 79'</b>	This program is suitable for drying daily clothes such as synthetic fibers or blended fabrics in a short period of time.	4.0 kg	✓	
<b>Cotton</b>	This program is suitable for drying thicker, non-sensitive cotton clothes.	9.0kg	✓	
<b>Synthetics</b>	This program is suitable for drying synthetic and cotton fabrics.	4.5kg	✓	
<b>Wool</b>	The program is suitable for drying wool and delicate clothing (refer to the drying instructions on the clothing label).	1.0 kg		✓
<b>Quick 30'</b>	This program is suitable for quick drying of lightweight and small items (fewer than 3 pieces).	1.0 kg	✓	
<b>Time Dry</b>	This program is suitable for thorough drying of non-sensitive clothing. During the drying process, the remaining moisture of the clothes will not be automatically detected. Select a suitable drying time to avoid the clothes not achieving the expected drying effect or over-drying causing creases.	/		✓
<b>Shirts</b>	This program is suitable for drying shirts made of cotton, linen, polyester, synthetics or blends.	2.0 kg	✓	
<b>Towels</b>	This program is suitable for drying non-sensitive clothing (fleece, kitchen wiping cloths, etc.).	4.5kg	✓	
<b>Bedding</b>	This program is designed with the anti-tangling function for large pieces of clothing and is suitable for drying large pieces of clothing.	2.5 kg	✓	
<b>Sportswear</b>	This program is suitable for drying outdoor clothing and sportswear made of synthetics.	2.0 kg	✓	
<b>Delicates</b>	The program is suitable for drying very delicate synthetic fiber clothing. The clothing may be slightly damp after the program ends. It is recommended to put the clothes in a special mesh laundry bag for drying.	1.5kg	✓	
<b>Allergy Care</b>	This program is suitable for high-temperature drying of clothing to remove allergens such as mites.	2.0 kg		✓
<b>Auto</b>	This program is suitable for drying non-sensitive synthetics and cotton clothing with uniform thickness.	4.5kg	✓	
 <b>Additional Cycles</b>				
<b>Pet</b>	This program is suitable for drying clothes that have pet hair after washing and spinning.	2.5 kg	✓	
<b>Down</b>	This program is suitable for drying down-filled clothing (such as pillows and down jackets). Please dry large pieces of clothing separately, using the Time Dry program if necessary.	2.0 kg	✓	
<b>Baby Care</b>	This program is suitable for drying infant and toddler clothing.	2.0 kg	✓	

Energy efficiency test program: Cotton + Wear immediately + Press and hold Time Dry for 3 seconds.

 If your clothing has not reached the expected drying level, please use another function or select a more suitable drying program.

**Note for Additional Cycles:**

To use the Additional Cycles function, the user needs to turn on the APP remote control module of the device and connect the APP to the smartphone.

When the device is not connected to the network, the default program for Additional Cycles is "Sportswear". After connecting, the user can select "Sportswear, Towels, Delicates, Power Speed 79" and other programs in Additional Cycles through the mobile APP.

# ADDITIONAL SETTINGS AND FUNCTIONS

The program comes with default settings, and some functions can be changed by user. You can adjust the settings by pressing the corresponding function button (before pressing the **Start/Pause** button).

Some settings cannot be selected or changed in some programs. These settings will not light up, and the buttons are inactive (see "FUNCTION SELECTION TABLE").

Most functions can only be set in standby mode, i.e., before a program starts. After starting the program, most functions cannot be adjusted anymore.



## 1 Power

Used to turn the device's power on or off.

If you need to shut down the program during operation, press and hold the "Power" button to shut down.

## 2 Start/Pause

Used to start/pause a program.

The device cannot be started if the door is not closed or the door lock is not locked.

## 4 Options

Press this button to select additional functions for the program. The corresponding icon lights up when an additional function is selected.

### Gentle Dry

We recommend drying at a relatively low temperature to protect your clothes.

The mode is not available for some programs.

### Anti Crease

The function enables the anti-crease mode. After the program ends, the inner drum rotates intermittently to prevent clothes from forming creases when the clothes are not taken out for a long time.

When this function is activated, the appliance automatically enters Anti Crease mode at the end of the program. During the anti-crease mode, pressing any key, turning the knob or opening the door can end this function.

If no operation is performed, the program will automatically end after a maximum of 12 hours by default.

## 5 Dry Level

The function selects the drying effect of the stop-on-drying programs.

It displays the current drying effect for the first time. Press this button to cycle through the set gears. The

drying effect can be selected in the following gears:    . The drying effect gears that can be set for each program are different.

"☀️+" Extra: After drying, the clothes are ready for storage.

"👔" Cupboard: After drying, the clothes can be worn immediately.

"👕" Iron: After drying, the clothes contain a small amount of moisture and can be ironed again.  
The function only applies to stop-on-drying programs and not to timed drying programs.



## 6 Time Dry +/-

The function increases or decreases the drying time of the timed drying programs.

Before starting a program, press the button to display the current drying time for the first time. Press the button again to cycle through the gears set for the preset time slots. Available gears vary depending on the programs. The function only applies to timed drying programs and not to stop-on-drying programs.

Please select a suitable drying time. If the drying time is too short, the clothes may not be completely dried.

## 7 Drum Light 📺

The option manually turns Drum Light on/off.

When the door is opened, the power is on, the program is paused, or the program has ended, or when the main knob is rotated, or any button is touched while the power is on, the Drum Light automatically illuminates.

## 8 Night Dry 🌙

This function can reduce drying noise, making it suitable for drying clothes at night.

Press this button, and the icon "🌙" will light up, indicating that this function is enabled. Press the button again to turn the function off.



To prevent children from operating the device accidentally and protect their safety, this device is equipped with a Child Lock function.

Long-press the button, the Child Lock icon "🔒" lights up and the child lock function is turned on.

The same operation can be used to disable the Child Lock.

When the child lock is enabled, only the Power button's on/off operation and the child lock release function are available; all other functions and knob operations are locked.

When the program ends or the appliance is powered off and restarted, the Child Lock function is automatically canceled.

## 9 Mute 🚫

This function can mute all prompt sounds except the alarm sound.

When the device is in standby, pause, or running state, press the button, the "🚫" icon lights up and the

Mute function is turned on. The same operation can disable the Mute function, and all prompt sounds will be reactivated.

When the program ends or the device is turned off and restarted, the Mute function setting remains unchanged.



## 10 Delay End 🕒

This function allows you to schedule drying clothes at your convenience.

After selecting the program and function, make a reservation. Press this button to set a delayed start; press it again to cycle through the set time gears. Each press adjusts the time by 1-hour increments. The maximum selectable time is 24 hours.

The reservation time is the end time of the program, including the entire program running time, so the reservation time must be greater than the program running time.

After selecting the delay end time, press the **Start/Pause** button to start the Delay End process.

When the reservation process is in progress, the icon 🕒 on the display lights up or flashes. When the reservation process finishes, the icon goes off.

If the Delay End function has been selected before the program starts, it can be canceled by selecting another program or function button.

After the program is started, if you need to cancel the Delay End function, you need to shut down and restart.

## 11 APP 📱

The function activates the APP remote control module of the device.

Short-press the button, the 📱 icon lights up, and the APP remote control module of the device is activated.

The same operation can be used to turn off this function. Before activating the APP function, check and make sure that the Wi-Fi function is turned on and connected normally.

When the Wi-Fi function is turned on and connected normally, and the 📱 icon on the screen is not lit, you can view the status or set the program parameters and function items (depending on the different permissions of the model) through your mobile phone, but you cannot start the program remotely.

When the Wi-Fi function is enabled, and the device is connected correctly, the 📱 icon will illuminate on the screen. At this point, you can use your mobile phone to set program parameters and options, and remotely start the program.

Once the Remote Control is activated, if the door of the appliance is opened at any time before it starts, the remote activation function will be canceled. You need to enable Remote Control again to remotely start the program.

After turning on Remote Control mode, if there is no operation on the entire machine and the App for a period of time, it will enter Energy Saving mode, and it will automatically shut down if there is no operation within 7 days.

After the Remote Control is started, children should be closely monitored to prevent them from crawling into the drum and causing danger.

### \* Connect 📶

Wi-Fi intelligent control function is supported on this device. Long press this button, the 📶 icon flashes, and the Wi-Fi function is turned on. The same operation can be used to turn off the Wi-Fi function.

### Network configuration steps:

1. Press the Power button to turn on the appliance.
2. Long-press the "\*\*Connect" button until the 📶 icon flashes and "b0n" is displayed on the screen.
3. Open the APP, and follow the instructions to connect the appliance to the network.
4. If not successful, you can start over from step one.

After the appliance is successfully connected to the network and paired, the Wi-Fi icon stays solid. The remote control module of the appliance is activated, and the appliance can be remotely controlled through the mobile APP.

12





## 12 Display

Used to display the remaining time of the program, reservation time, fault code, and other related information.

The remaining time indicated by the program may differ from the actual running time. Due to factors such as clothing type and quantity, drying grade, and ambient temperature, the device will automatically adjust the actual drying time.

### Icon description

	<p>Water box empty icon. When this icon is on, the condensate box needs to be emptied. After emptying and resetting the condensate box, press the <b>"Start/Pause"</b> button to resume operation.</p>
	<p>Lint and debris cleaning icon. When this icon flashes, it means that lint and debris need to be cleaned.</p>
	<p>Evaporator cleaning icon. When this icon is on, it means the appliance has been run 20 times and the evaporator needs to be cleaned.</p>

# FUNCTION SELECTION TABLE

	Program	Gentle Dry	Anti Crease	Dry Level	Time Dry +/-	Drum Light	Night Dry		Mute	Delay End
SENSOR DRY	Power Dry 79'	-	•	-	-	•	-	•	•	•
	Cotton	•	•	•	-	•	•	•	•	•
	Synthetics	•	•	•	-	•	•	•	•	•
	Quick 30'	-	•	-	-	•	-	•	•	•
	Shirts	•	•	•	-	•	-	•	•	•
	Towels	•	•	•	-	•	•	•	•	•
	Bedding	-	•	•	-	•	•	•	•	•
	Sportswear	•	•	•	-	•	-	•	•	•
	Delicates	•	•	•	-	•	-	•	•	•
	Auto	•	•	•	-	•	•	•	•	•
	Pet	•	•	•	-	•	-	•	•	•
	Down	-	•	•	-	•	-	•	•	•
Baby Care	-	•	•	-	•	-	•	•	•	
MANUAL DRY	Wool	•	•	-	•	•	-	•	•	•
	Time Dry	-	•	-	•	•	-	•	•	•
	Allergy Care	-	•	-	•	•	-	•	•	•

- The function is optional
- The function is not optional

# SMART NETWORKING

Enter the "Settings" interface of your smartphone or tablet PC, enable Bluetooth and wireless connections, and connect to a wireless network.

## Note:

This appliance supports 2.4 GHz Wi-Fi.

When the Wi-Fi function is activated, the energy consumption of the appliance will increase. However, the Wi-Fi power is less than 2W, so it has no impact on the energy efficiency rating of the appliance.

## Download

In the app store on your smartphone or tablet PC (Google Play Store or Apple App Store), you can find the ConnectLife application, download and install it.

## Note:

To improve performance and experience, the application may be updated without notice.

## Log in

You need to log in to ConnectLife with your account first. If you don't have a ConnectLife account, you need to create a new account. Please refer to the application usage instructions for details.

## Note:



If you already have a Google account, you can use your Google account to log in directly.

### Device Binding

1. Open ConnectLife on your smartphone or tablet PC.
2. Bind your appliance on ConnectLife as follows:
  - A. Click "+" on the "Home" interface, and select "Add device" or "Scan".
  - B. Select "TUMBLE DRYER" or click "Scan QR/BAR code" or "Manual entry" below.
  - C. Scan the "QR/BAR code" on the appliance or manually enter the "AUID/SN" of the appliance. If you can't find it, click "?" to view instructions.
  - D. Click "SET UP APPLICATION".
  - E. Read the instructions and operate the appliance until it reaches "Networking" or "Binding" state, then click "NEXT".
  - F. At this time, APP begins searching for devices. You can select the device you want to connect to the network from the search list; if no device is found, please check whether your Bluetooth is turned on. Please keep Bluetooth turned on at all times, and click "NEXT".
  - G. Select your home Wi-Fi, enter the password, and then click "CONNECT". The device starts networking and binding.
  - H. After the binding is successful, you can set the device name and room.
  - I. Now you can remotely control the device through the APP.

## Note:

How to reset Wi-Fi and unbind all devices?

1. Turn on the device power and make sure the  icon lights up or blinks.
2. Long-press the "Time Dry +/- + Delay End" buttons at the same time until " -b" is displayed on the screen.
3. Power off and restart the device to perform the new binding.
4. After unbinding, you must restart the device; otherwise, the next binding will fail. Unbinding will delete the user information previously stored in the device.
5. How to exit the network pairing mode?

If you want to cancel the network connection when " -b" is displayed on the screen, no operation is required, and it will automatically exit after the timeout.

 Some models do not support unbinding on the device; unbinding can be done through the APP.

# START THE PROGRAM

Select the program and additional functions, and press **Start/Pause** button to start the program.



# END OF THE PROGRAM

When the program finishes, the device emits an acoustic signal and "End" appears in the display. Press and hold the Power button to turn off the device.

In standby mode, at the end of the program, if no operation is performed for a period of time, the device will automatically shut down.

 - After the program ends, turn off the device, open the door and take the clothes out of the drum.

# MAINTENANCE AND CLEANING

 Regular maintenance can extend the appliance's service life. Before maintenance, please be sure to disconnect the power supply.

 Children are not allowed to clean or perform any maintenance work on this device without supervision. The dryer is equipped with a filtration system made up of several filters that prevent impurities from entering the heat exchanger system.

 The device must not be operated if the filter is not installed in place or the filter is damaged, as excessive accumulation of fabric fibers may cause the device to malfunction or fail.

 Never use harsh chemicals, abrasive cleaners, or solvents to clean the appliance. They will damage the finish.

## CLEANING THE FILTER

 Please clean the filter after each use.

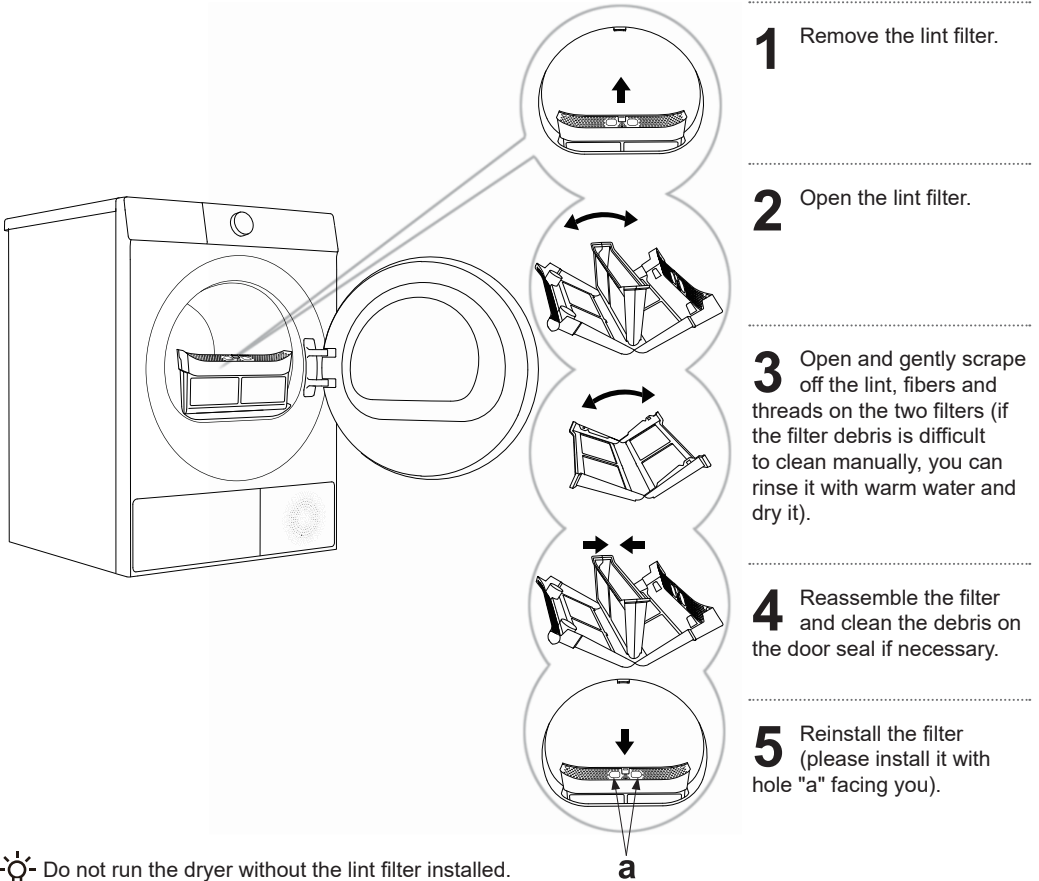

 Do not run the dryer without the lint filter installed.

 Please be careful not to get your fingers caught in the filter cover.

 Refer to the instructions to clean the filter properly, otherwise it will cause lint accumulation and affect the drying performance of the device. Proper and timely cleaning of the filter can reduce the drying time and energy consumption of the device and prevent unnecessary malfunctions.

# CLEAN THE HEAT EXCHANGER

 When cleaning the heat exchanger, water may overflow; it is recommended to place an absorbent cloth on the floor.

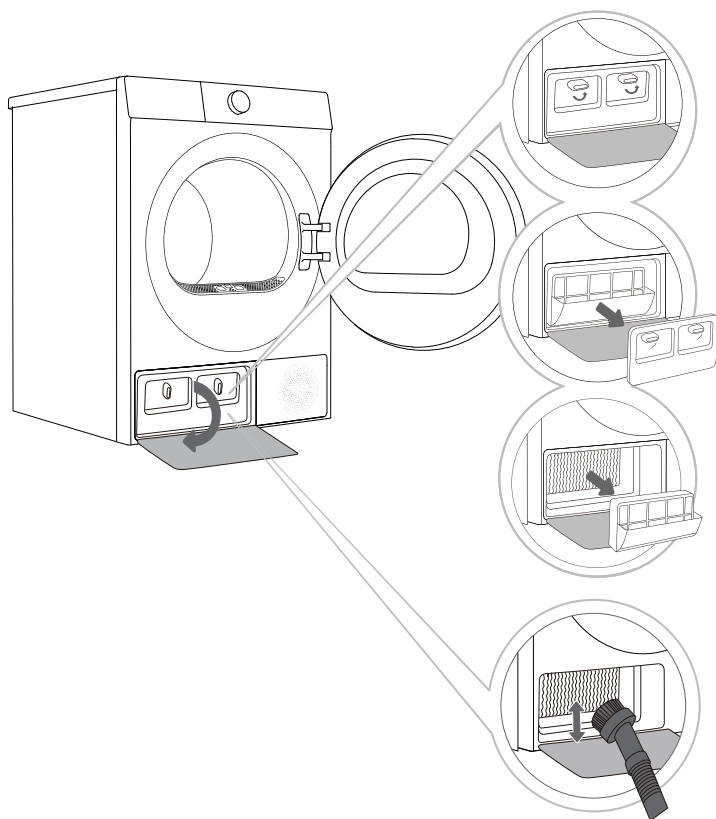

**1** Press the heat exchanger door cover buckle on the lower left to open the door cover.

**2** Turn the locking knob on the inner door cover to the unlocked position.

**3** Remove the inner door cover and take out the heat pump filter. Clean the dust on the filter with a damp cloth or running water. After cleaning, dry the filter.

**4** If after using for a period of time, there is dust on the heat exchanger, please use a vacuum cleaner, soft brush, or other tools to remove the dust. The heat exchanger can be seen after removing the heat pump filter. Lightly brush the metal sheet with the brush, and the brush can only be moved from top to bottom. Excessive force may damage or bend the metal sheet. Do not touch the heat exchanger directly with your hands to avoid injury.

**5** After cleaning, reinstall the heat pump filter and inner door cover to their original positions, tighten the knob, and close the heat exchanger door cover.

 Do not touch the internal metal parts of the heat exchanger with your bare hands to avoid scratches. Wear suitable protective gloves when cleaning the heat exchanger.

 Improper cleaning of the heat exchanger metal sheets may cause permanent damage to the device. Do not press the metal sheet with hard objects (such as the plastic tube of a vacuum cleaner, etc.).

 It is recommended to clean the heat exchanger at least once every 20 drying programs.

# EMPTY THE CONDENSATE BOX

If the condensate box is full, the drying program will automatically pause. Please follow the steps below to empty the condensate box.

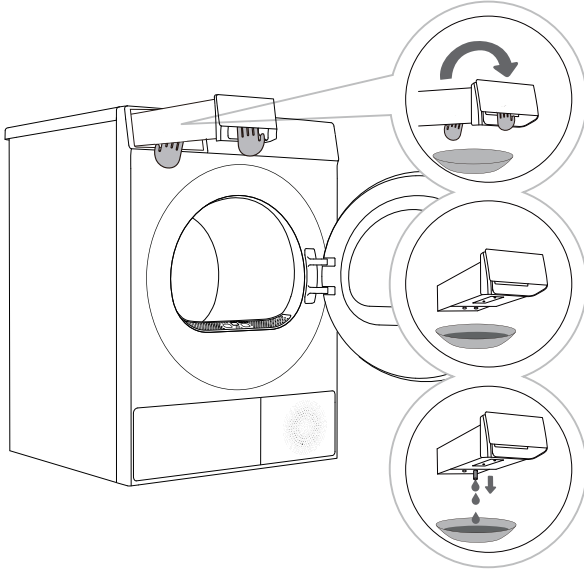

**1** Pull out the condensate box (using both hands as shown).

**2** Turn the condensate box upside down over a basin, sink, or any suitable container.

**3** Empty the condensate box.

**4** Reinstall the condensate box.

💡 Empty the condensate box after each drying cycle.

💡 The water discharged from the condensate box is not for drinking. After sufficient filtering, it can be used for ironing.

💡 Do not add chemicals or fragrances to the condensate box.

## CLEAN THE WATER TANK FILTER (APPLICABLE TO SOME MODELS)

 The water tank filter may be clogged with impurities after long-term use; it is recommended to clean it once a month.

- If the appliance is equipped with the steam function program, ensure that there is sufficient water in the water tank to form steam. When using for the first time or when the low-water icon appears on the screen during operation, please add purified water.
- For the models without the steam function program, there is no need to add purified water into the water tank; simply remove the water tank filter for cleaning.

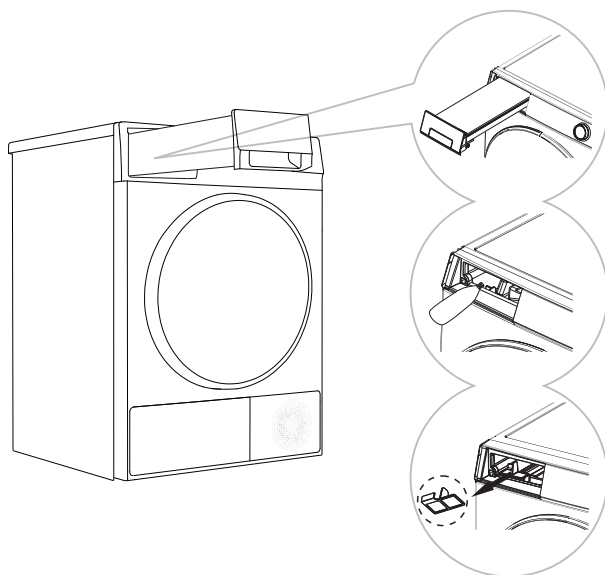

**1** Pull out the condensate box by pulling it outward.

**2** Pour approximately 500 ml of purified water into the water tank using a water kettle or a pointed mineral water bottle.

**3** Reach in with your fingers to grasp the water tank filter at the bottom, remove it, clean it, and reinstall it in place. Finally, reinstall the condensation box to its original position.

## CLEAN THE DOOR SEAL

Check the door seal regularly; clean it with a damp cloth if necessary.

 After use, slightly open the door for ventilation and drying.

## CLEANING THE OUTSIDE OF YOUR WASHER

 **Before cleaning the outside of your washer, please be sure to disconnect the machine from the power supply.**

Clean the appliance housing and control panel with a soft, damp cloth. Then wipe them dry with a soft dry cloth.

 Do not use solvents, abrasive cleaners, or cleaner that may damage the device (Please follow the recommendations and warnings provided by the cleaner manufacturer).

Wipe the drum door with a damp cloth, and then wipe it dry with a soft dry cloth.

 If cleaning with a wet towel, make sure to ring out the water from the towel before wiping down the washer.

# TROUBLESHOOTING

The device is equipped with various automatic safety functions, ensuring that faults can be detected promptly and effective safety countermeasures can be initiated. These faults are usually minor and can be eliminated in a very short time.

When the device cannot operate normally, the display will show abnormal information. Please refer to the warning content and take appropriate actions.

**If the fault persists after you have handled it yourself according to the recommended processing method, please contact after-sales service.**

If the user performs maintenance by themselves or hires non-manufacturer after-sales personnel, all consequences will be assumed by the user.

Fault Description	Recommended handling methods
<b>The device cannot start</b>	<ul style="list-style-type: none"> <li>◇ Check the power connection.</li> <li>◇ Check whether the Start/Pause button is pressed.</li> <li>◇ Check whether the door is closed correctly.</li> <li>◇ Check whether a fuse has blown, a circuit breaker has tripped, or a power outage has occurred.</li> </ul>
<b>The device cannot start, and the screen displays "End".</b>	<ul style="list-style-type: none"> <li>◇ Check whether the program settings are correct.</li> <li>◇ Check whether there are any clothing items in the drum.</li> </ul>
<b>Drying time is too long</b>	<ul style="list-style-type: none"> <li>◇ Check whether the program settings are correct.</li> <li>◇ Check whether there is too much clothing tangled into a bunch.</li> <li>◇ Check the filter for cleanliness.</li> <li>◇ Some programs have a cooling process after drying.</li> </ul>
<b>Poor drying effect</b>	<ul style="list-style-type: none"> <li>◇ Check whether the clothes have been washed and spun.</li> <li>◇ Check whether the program settings are correct.</li> <li>◇ Check whether the amount of clothing is too much.</li> <li>◇ Check whether the clothing is sorted correctly and whether the clothing that dries easily is mixed with the clothing that dries slowly.</li> <li>◇ Check whether there are too many heavy garments.</li> <li>◇ Check whether the filter is clean.</li> </ul>
<b>The remaining time on the display stops or jumps</b>	<ul style="list-style-type: none"> <li>◇ The remaining time may vary depending on the type of clothing, weight, moisture, and surrounding environment; this is a normal phenomenon.</li> </ul>
<b>Wrinkled clothing</b>	<ul style="list-style-type: none"> <li>◇ The drying time of the clothes is too long; try shortening the drying time.</li> <li>◇ Leaving clothing in the dryer for too long after the program has ended.</li> </ul>
<b>The program running time displayed on the device is different from the actual program running time</b>	<ul style="list-style-type: none"> <li>◇ For programs that stop automatically when clothes are dry, the drying duration displayed is calculated according to standard environment, initial laundry moisture, load mass and type. The drying time is automatically adjusted for any change in conditions. The difference between the actual time and the display time is normal, which ensures the best drying effect.</li> </ul>

 Faults or problems caused by external factors (such as lightning strikes, power grid failures, natural disasters, etc.) are not covered by the warranty.

Fault Description	Recommended handling methods
<p><b>The appliance is too loud</b></p>	<ul style="list-style-type: none"> <li>◇ Look for coins, loose buttons, nails, and other objects and remove them immediately.</li> <li>◇ Check the lint filter. Remove any items stuck inside the lint filter.</li> <li>◇ Make sure the dryer is level and standing firmly on the floor.</li> <li>◇ The dryer may hum due to air moving through the drum and fan. This is normal.</li> </ul>
<p><b>Clothes are shrinking</b></p>	<ul style="list-style-type: none"> <li>◇ Garment care instructions are not being followed. Use a low or no heat setting.</li> </ul>
<p><b>Lint is left on clothes</b></p>	<ul style="list-style-type: none"> <li>◇ Lint filter has not been cleaned properly.</li> <li>◇ Clothes have not been sorted properly.</li> <li>◇ Some fabrics cause more lint and should be dried separately from fabrics that lint attaches easily.</li> <li>◇ Tissue, paper, etc., has been left in pockets.</li> </ul>
<p><b>The appliance has an odour</b></p>	<ul style="list-style-type: none"> <li>◇ The smell is caused by rubber material that is attached to the appliance inside. This kind of smell is a rubber's own smell and disappears automatically after using the appliance several times.</li> <li>◇ When washing the clothes, use the detergent in accordance with the manufacturers recommendations. If you use the detergent excessively not according to the recommendations, undissolved detergent may accumulate on the clothes and cause an odour.</li> <li>◇ You can smell odours from the clothes if the clothes were left in the appliance after drying or in the washing machine after washing. Unload the clothes promptly at the end of the drying or washing cycle.</li> <li>◇ Ensure you can smell same odour in the washing machine. If so, clean the tub of the washing machine referring to the washing machine user manual.</li> <li>◇ Always take care of both lint filters clean. If any residues were left in the lint filter after drying, it may cause odours. And also dry the lint filter completely after cleaning.</li> </ul>
<p><b>The appliance is powered on and started directly after power failure, but does not work</b></p>	<ul style="list-style-type: none"> <li>◇ When the program is suspended, the set functions cannot be changed, If the program or function needs to be changed during operation, or the power is off during operation and the power needs to be powered on again, select the required program and function, and finally start it.</li> </ul>

# FAULT CODES AND TROUBLESHOOTING

When the device does not operate normally and the display shows the following code, it may not be a fault. Please refer to the content in the fault code and take the corresponding measures.

 Some fault codes are only applicable to certain models. The actual alarm display is subject to the actual model.

<b>Problem/ Fault</b>	<b>Description</b>	<b>Solution</b>
<b>F50/F51</b>	Abnormal sensor	Please contact after-sales service.
<b>F21</b>	Abnormal display panel and the power board	Switch off the appliance, and restart it. Press the "start/pause" button again If the abnormality is not removed, please contact after-sales service.
<b>F22</b>	Abnormal display the motor control board and the power board	Switch off the appliance, and restart it. Press the "start/pause" button again If the abnormality is not removed, please contact after-sales service.
<b>Other</b>	Electronic module fault	Switch off the appliance, and restart it. Press the "start/pause" button again If the abnormality is not removed, please contact after-sales service.

# SERVICING

## Before calling maintenance personnel

When you contact the service center, please first state your device model.

Information such as model number, code/ID, model type, and serial number are displayed on the nameplate of the device.

 In case of defects, only use spare parts approved by the authorized manufacturer.

 Repairs or any warranty claims resulting from incorrect connection or use of the device are not covered by the warranty. In this case, the maintenance costs shall be borne by the user.

## USAGE RECOMMENDATIONS

The most economical way of drying is to dry the recommended amount of laundry in each batch (see PROGRAMME TABLE).

Drying laundry made of particularly delicate fabrics that may be deformed is not recommended.

Use of conditioner in the washing cycle is not necessary as the laundry is soft and smooth after drying in the dryer. Drying time will be shorter and power consumption will be lower if the garments are thoroughly wrung or spun before drying. By selecting the appropriate drying programme, you will avoid over-drying your laundry and problems with ironing or shrinkage of fabric

Regular cleaning of the filters will lead to optimum drying time and minimum power consumption.

When drying smaller amounts of laundry or individual garments, the sensor may not perceive the actual level of moisture in the laundry. In such cases, it is recommended to dry smaller items or amounts with programmes for dryer laundry or with the timed programme.

# DISPOSAL



The packaging is made of environmentally friendly materials and can be recycled, reused, processed, or destroyed without causing harm to the environment. For this purpose, the packaging materials are marked with appropriate labels.

This icon on the product or its packaging indicates that this product cannot be disposed of as household waste. Please dispose of this product at a collection point for the recycling of electrical and electronic equipment.

When the device reaches the end of its life and needs to be scrapped, please remove all power cords, destroy door locks and switches to prevent the doors from locking. This is to avoid the risk of children or small animals becoming trapped inside.

Ensure this product is handled correctly and avoid inappropriate waste disposal measures for this product, as this helps prevent potential negative impacts on the environment and human health. For more information on product recycling, please contact your local municipal department, your household waste disposal service center, or the store where you purchased the product.

# PROGRAM TABLE

## Program Instructions

The table indicates the power consumption and time values for drying of a test batch of laundry with various loads and after washing machine spinning .  
The following requirements apply to the consumption values specified below.

Inlet air temperature	room temperature
Inlet air humidity	50–60%
Drying temperature	Normal

Program	Load size*	Final spin speed in washing machine (rpm)	Program consumption approximately (kWh)	Program duration approximately (h:min)
Cotton	9	1000	2.01	3:31
Bedding	2.5	1000	1.25	2:56
Baby care	2	1000	0.65	1:21
Shirts	2	1000	0.41	1:00
Power Dry79'	4	1400	0.63	1:19
Synthetics	4.5	1000	0.65	1:14
Down	2	800	0.78	2:03
Quick30'	1	1400	0.27	0:30
Sportswear	2	1000	0.62	1:16
Towels	4.5	1200	1.57	3:00
Auto	4.5	1000	1.34	2:43
Pet	2.5	1000	0.79	1:40
Delicates	1.5	600	0.51	1:08

 Due to deviations in terms of type and amount of laundry, spinning, power supply oscillation, and environment temperature and humidity, the values measured at the user may differ from the one stated in the table.

We reserve the right to any changes and errors in the instructions for use.

**Hisense**  
life reimagined