

# DENON

## DA-300USB

D/A CONVERTER

# Owner's Manual

You can print more than one page of a PDF onto a single sheet of paper.

[Front panel](#)[Display](#)[Rear panel](#)[Index](#)

# Contents

<b>Accessories</b> .....	3
<b>Features</b> .....	4
High quality sound.....	4
High performance.....	4

## Part names and functions

<b>Front panel</b> .....	5
<b>Display</b> .....	6
<b>Rear panel</b> .....	7

## Connections

<b>Placing this unit</b> .....	9
Horizontal placement.....	9
Vertical placement.....	10
<b>Connecting devices</b> .....	11
<b>Connecting the AC adapter</b> .....	12

## Playback

<b>Basic operation</b> .....	14
Turning the power on.....	14
Selecting the input source.....	14
Adjusting the headphone volume.....	14
Connecting and playing back from a computer (USB-DAC).....	15
Connect and playback from a digital device (COAXIAL/OPTICAL-1/OPTICAL-2).....	21

## Settings

<b>Setting the Auto Standby mode</b> .....	22
Turning Auto Standby mode on.....	22
Turning Auto Standby mode off.....	22

## Tips

<b>Contents</b> .....	23
Tips.....	24
Troubleshooting.....	25

## Appendix

Types of digital audio input signals available for playback.....	28
Input signals available for USB-DAC playback.....	28
Input signals available for COAXIAL/OPTICAL-1/OPTICAL-2 playback.....	28
Explanation of terms.....	29
Trademark information.....	30
Specifications.....	31
Index.....	32



Thank you for purchasing this Denon product. To ensure proper operation, please read this owner's manual carefully before using the product. After reading them, be sure to keep them for future reference.

## Accessories

Check that the following parts are supplied with the product.

① Getting Started

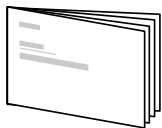

② CD-ROM (Owner's Manual)

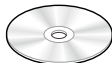

③ Safety Instructions

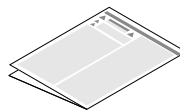

④ Warranty  
(for USA)  
(for CANADA)

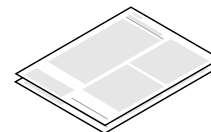

⑤ AC adapter

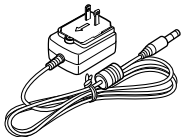

⑥ Audio cable

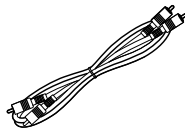

⑦ Stand for vertical placement

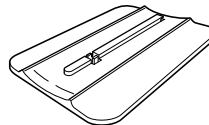

⑧ Feet for horizontal placement

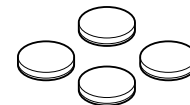

# Features

## High quality sound

- **Advanced AL32 Processing and High-precision 32 bit D/A Converter**

Equipped with Advanced AL32 Processing, Denon's own analog waveform reproduction technology.

The reproducibility of weak signals is enhanced by expanding 16 bit digital data to 32 bit.

Also equipped with a high-performance, 32 bit/192 kHz-compatible D/A converter for analog signal conversion of the digital data expanded with Advanced AL32 Processing.

- **Isolation design**

To prevent audio quality from degrading due to noise from external devices when this unit is connected to external devices such as computers, the ground circuit for the USB input interface device is isolated from the audio circuit.

## High performance

- **Playback of high resolution audio files supported**

DSD signals and PCM signals up to 192kHz/24bit are supported. You can experience high audio quality when you play back music by inputting music files with DSD or PCM signals stored on your computer to this unit through a USB connection.

- **Equipped with headphone amplifier**

This unit is equipped with a high quality headphone amplifier circuit. This allows you to enjoy playback with high quality audio when you listen to music with headphones as well.

- **Vertical placement supported**

This unit can be placed either vertically or horizontally. The display automatically rotates according to the placement orientation.

- **Equipped with a high visibility organic EL display**

- **Equipped with auto standby function that reduces power consumption** ( [page 22](#))



# Part names and functions

## Front panel

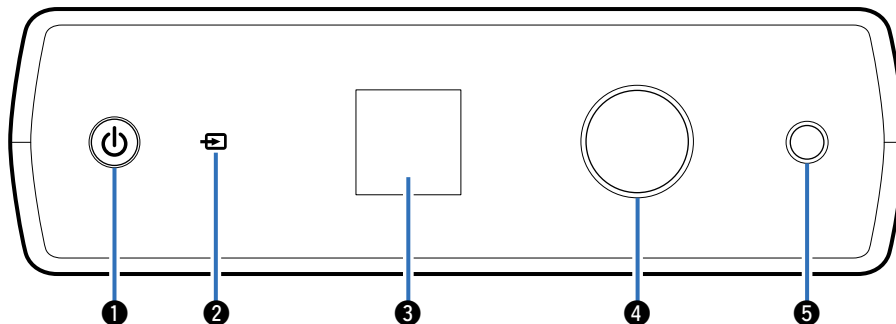

### 1 Power operation button/indicator (⏻)

This turns the power on/standby (🔗 page 14).

This is lit as follows according to the power status:

- Power on : Lit
- Standby : Off

### 2 Input source select switch (📺)

This selects the input source (🔗 page 14, 20, 21).

### 3 Display

This displays various pieces of information (🔗 page 6).

### 4 Headphone volume control knob

Adjusts the headphone volume (🔗 page 14).

- Even when the headphones are connected or the volume is adjusted, the volume from the analog audio output connector does not change.

### 5 Headphones jack

Used to connect headphones.

#### NOTE

- To prevent hearing loss, do not raise the volume level excessively when using headphones.



# Display

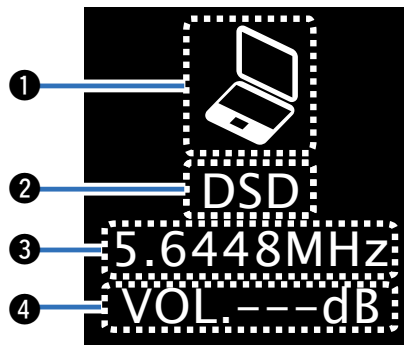

## 1 Input source indicator

The following is displayed according to the selected input source.

USB-DAC	COAXIAL	OPTICAL-1	OPTICAL-2

## 2 Input signal format indicator

The input audio signal format is displayed.

## 3 Sampling frequency indicator

The input audio signal sampling frequency is displayed.

## 4 Headphone volume indicator

The headphone volume level is displayed.

- By default, the volume level is displayed as “---dB” (muted).



## Rear panel

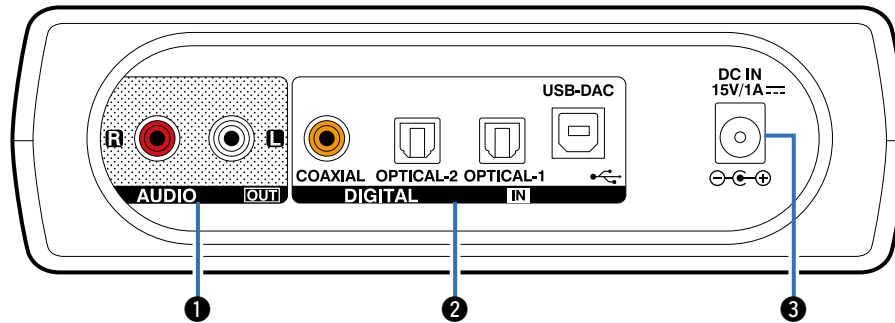

### 1 AUDIO OUT connectors

Used to connect a amplifier ([page 11](#)).

### 2 DIGITAL IN connectors

Used to connect a PC or devices equipped with digital audio output connectors ([page 11](#)).

### 3 AC adapter inlet (DC IN)

Used to connect the AC adapter ([page 12](#)).



# Connections

**Placing this unit** (👉 page 9)

**Connecting devices** (👉 page 11)

**Connecting the AC adapter** (👉 page 12)

## NOTE

- Do not plug in the power cord until all connections have been completed.
- Do not bundle power cords together with connection cables. Doing so can result in humming or noise.

## ■ Cables used for connections

Provide necessary cables according to the devices you want to connect.

Audio cable  
(Supplied)



Optical cable  
(Sold separately)



Coaxial digital cable  
(Sold separately)



USB cable  
(Sold separately)



## Placing this unit

Place this unit horizontally or vertically according to the location and your preferences.

### Horizontal placement

When placing this unit horizontally, attach the provided feet for horizontal placement to the bottom.

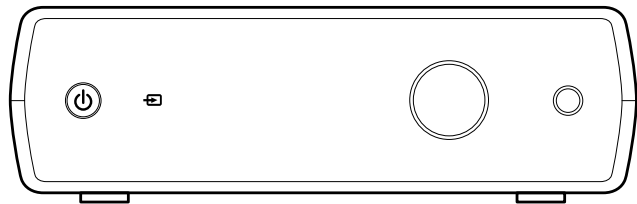

### ■ How to attach the feet for horizontal placement

Attach the feet for horizontal placement to this unit as shown in the diagram below.

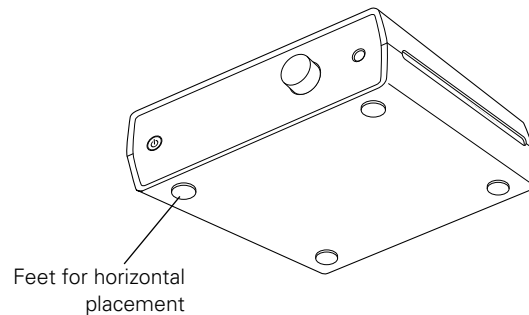

## Vertical placement

When placing this unit vertically, attach the stand for vertical placement to this unit with the power button in the upper position as shown in the diagram.

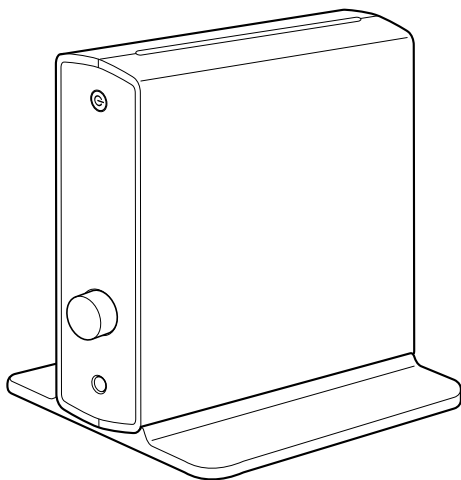

### ■ How to attach the stand for vertical placement

- ① Align the rear edge of this unit to the guide position.
- ② Press down this unit onto the stand until it clicks.
- ③ Slide this unit in the arrow direction to align the edge of this unit with that of the stand.

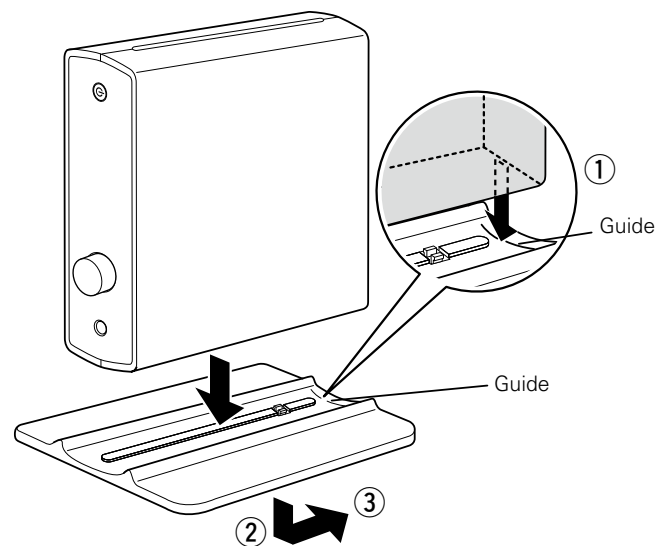

- To remove the stand from this unit, follow the above steps for attaching the stand in the reverse order.



## Connecting devices

- For USB-DAC playback, install the dedicated driver software and player software on your computer before connecting (“Installing the dedicated driver (Windows OS only)” (🔗 page 15)).
- Download the driver software from the DA-300USB page of the Denon website.

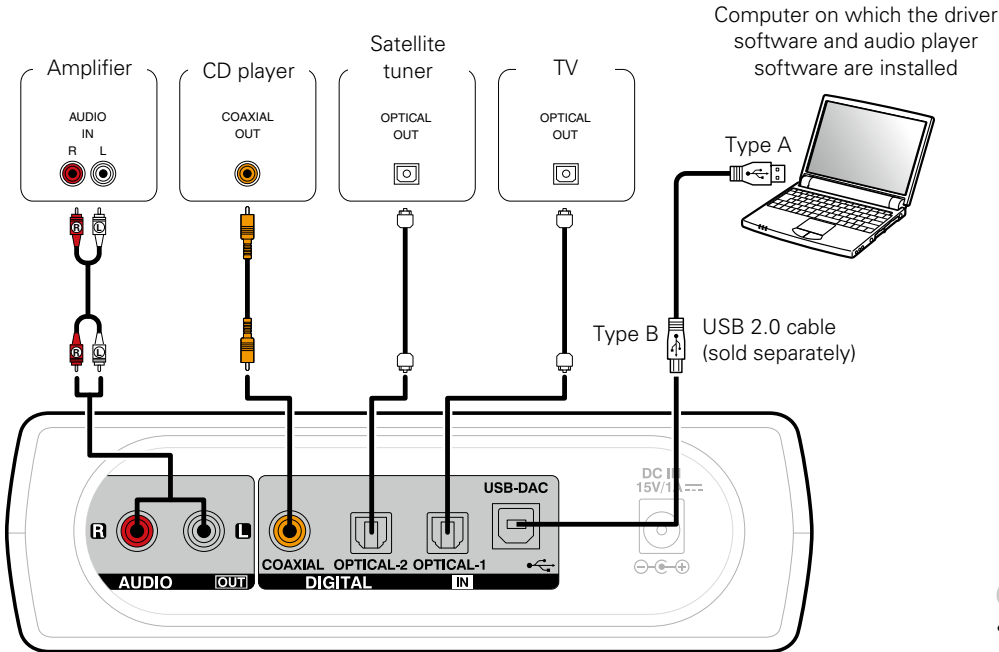

### NOTE

- Use a cable that is 10 ft (3 m) or less to connect to the computer.



## Connecting the AC adapter

After completing all the connections, insert the AC adapter into the power outlet.

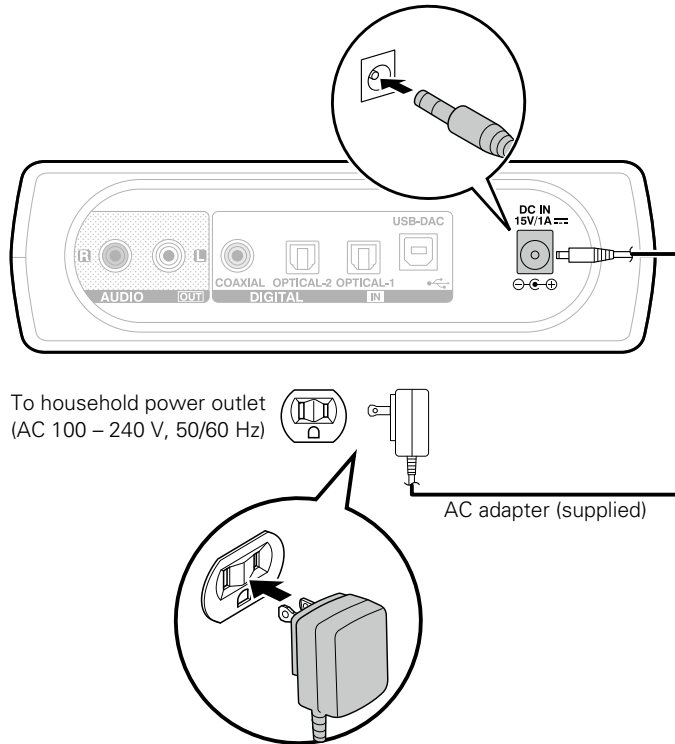
**NOTE**

- Do not use an AC adapter other than the provided one.



# Playback

**Turning the power on** (👉 page 14)

**Selecting the input source** (👉 page 14)

**Adjusting the headphone volume** (👉 page 14)

**Connecting and playing back from a computer (USB-DAC)**  
(👉 page 15)

**Connect and playback from a digital device (COAXIAL/  
OPTICAL-1/OPTICAL-2)** (👉 page 21)



## Basic operation

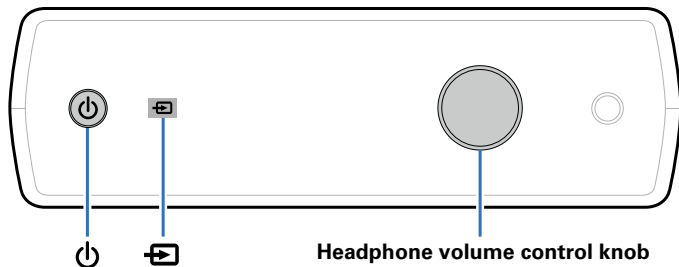

### Selecting the input source

- 1 Touch  to switch the input source for playback.

**USB-DAC** : Plays music files on your computer.

**COAXIAL** : Plays devices connected to the COAXIAL connector.

**OPTICAL-1** : Plays devices connected to the OPTICAL-1 connector.

**OPTICAL-2** : Plays devices connected to the OPTICAL-2 connector.

### Turning the power on

- 1 Press  to turn on power to the unit.  
The power indicator turns on.

### Switching the power to standby

- 1 Press .  
The power indicator turns off.

#### NOTE

- Power continues to be supplied to some of the circuitry even when the power is in the standby mode. When leaving home for long periods of time or when going on vacation, unplug the AC adapter from the power outlet.

### Adjusting the headphone volume

- 1 Turn the headphone volume control knob to adjust the volume.  
The display shows the volume level.



## Connecting and playing back from a computer (USB-DAC)

Enjoy music playback with high audio quality by inputting music files with DSD or PCM signals stored on your computer to this unit through a USB connection.

- Before connecting this unit to your computer, install the driver software in your computer.
- Drivers do not need to be installed for Mac OS.
- As a playback player on your computer, use a commercially available or downloadable player software of your choice that supports the playback of high resolution audio sources.

### ■ Computer (recommended system)

#### OS

- Windows® XP Service Pack3, Windows® Vista, Windows 7 or Windows 8
- Mac OS X 10.6.3 or later

#### USB

- USB 2.0: USB High speed/USB Audio Class Ver.2.0

### ■ Installing the dedicated driver (Windows OS only)

#### □ Installing the driver software

- 1 Disconnect the USB cable between your PC and the unit.**
  - The driver software cannot be installed correctly if your PC is connected to the unit by a USB cable. When your PC was started with the USB cable connected, disconnect the USB cable and restart your PC.
- 2 Download the dedicated driver from the “Download” section of the DA-300USB page of the Denon website onto your PC.**
- 3 Unzip the downloaded file.**
- 4 Select the 32 bit or 64 bit exe file that matches your Windows operating system, and double-click the file.**



## 5 Install the driver.

- ① Select the language to use for the installation.
- ② Click "OK".



- ③ The wizard menu is displayed. Click "Next".

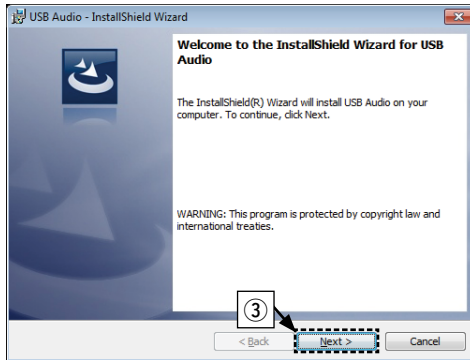

- ④ Read the Software Licensing Agreement, and click "I accept the terms in the license agreement".
- ⑤ Click "Next".



- ⑥ Click “Install” on the installation start dialog.
- The installation starts. Do not perform any operation on the PC until the installation is completed.

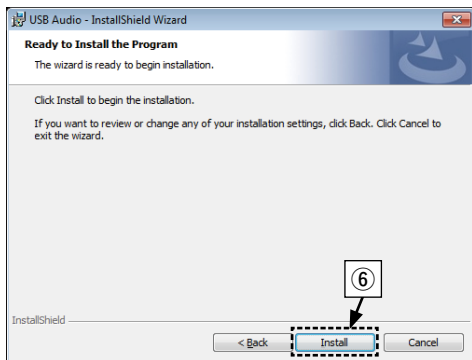

- ⑦ In the Windows security dialog, select “Always trust software from DandM Holdings Inc.”.
- ⑧ Click “Install”.

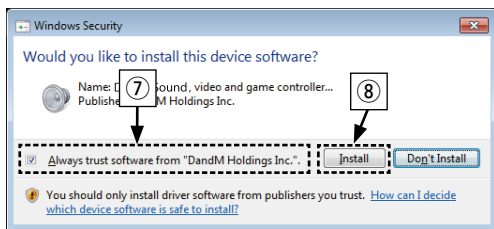

- ⑨ When the installation is completed, click “Finish”.

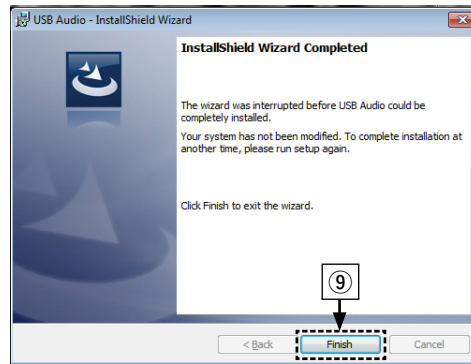

## 6 With the unit power off, connect the unit and PC using a USB cable (sold separately).

- For the connection procedure, refer to the “Connecting devices” (🔗 page 11) section.

## 7 Press on this unit.

- When the unit power is turned on, the PC automatically finds and connects to the unit.

## 8 Touch to change the input source to “USB-DAC”.



## 9 Checking the installed driver.

- ① Click the “Start” button and click “Control Panel” on the PC.
  - The control panel setting list is displayed.
- ② Click the “Sound” icon.
  - The sound menu window is displayed.
- ③ Check that there is a checkmark next to “Default Device” under in “Digital Audio Interface” of the “Playback” tab.
  - When there is a checkmark for a different device, click “Denon USB Audio” and “Set Default”.

## 10 Checking audio output.

Outputs a TEST signal from the PC and checks the audio output from the USB-DAC function.

- ① Select “Digital Audio Interface” and click “Properties”.
  - The Digital Audio Interface Properties window is displayed.



- ② Click the “Advanced” tab.
- ③ Select the sampling rate and bit rate to be applied to the D/A converter.
  - It is recommended that “24 bit, 192000 Hz (Studio Quality)” is selected.
- ④ Click “Apply”.
- ⑤ Click “Test”.
  - Check that audio from this unit is output from the PC.

**NOTE**

- The dedicated driver must be installed in the PC before this unit is connected to a PC. Operation will not occur correctly if connected to the PC before the dedicated driver has been installed. Moreover, if the PC is running Windows XP as its OS, the PC’s speed will decrease significantly, and a PC restart may be required.
- Operation may fail in some PC hardware and software configurations.

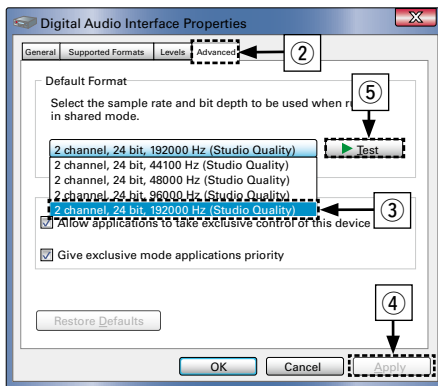

## ■ Playback

- Install the desired player software on your computer beforehand.
- Use the rear panel USB-DAC port to connect this unit to a computer. For the connection procedure, refer to the “Connecting devices” (🔗 page 11) section.

**1** Touch  to change the input source to “USB-DAC”.

**2** Start playback on the computer’s player software.

The digital audio signal that is being input is shown as follows in the display.

“PCM            or            “DSD  
xxxxxkHz”            xxxxxMHz”

(xxxxx is the sampling frequency.)

- If the sampling frequency cannot be detected, “Unlock” will be displayed.
- “Unsupported” is displayed when audio signals that are not supported by this unit are input.

## ■ Files that can be played back

See “Input signals available for USB-DAC playback” (🔗 page 28).

### NOTE

- Perform operations such as playback and pause on the computer.
- You can also control the volume and equalizer on the computer. Enjoy playing music at the desired volume.
- No audio is output from the speakers of your computer while this unit is in operation.
- If the computer is disconnected from this unit while the computer music playback software is running, the playback software may freeze. Always exit the playback software before disconnecting the computer.
- When an abnormality occurs on the computer, disconnect the USB cable and restart the computer.
- The sampling frequency of the music playback software and sampling frequency displayed on this unit may differ.
- Use a cable that is 10 ft (3 m) or less to connect to the computer.



## Connect and playback from a digital device (COAXIAL/OPTICAL-1/OPTICAL-2)

### 1 Connect digital device to this unit (🔗 page 11).

### 2 Touch to select the input source to "COAXIAL", "OPTICAL-1" or "OPTICAL-2" (🔗 page 14).

The digital audio signal that is being input is shown as follows in the display.

"PCM  
xxxxxkHz"

(xxxxx is the sampling frequency.)

- If the sampling frequency cannot be detected, "Unlock" will be displayed.
- "Unsupported" is displayed when audio signals that are not supported by this unit are input.

### ■ Files that can be played back

See "Input signals available for COAXIAL/OPTICAL-1/OPTICAL-2 playback" (🔗 page 28).

#### NOTE

- Do not input non-PCM signals, such as Dolby Digital, and DTS. This causes noise and could damage the speakers.
- If the sampling frequency switches, muting may operate for 1 – 2 seconds, cutting the sound.



# Settings

## Setting the Auto Standby mode

You can set the unit to automatically switch to standby mode if the unit is not operated for 30 minutes when there is no audio input. Auto Standby mode is set to off by default.



### Turning Auto Standby mode on

- 1 Press and hold  for more than 5 seconds.**  
The display shows "Auto Standby On".

### Turning Auto Standby mode off

- 1 Press and hold  for more than 5 seconds.**  
The display shows "Auto Standby Off".



# Tips

## Contents

■ <b>Tips</b> .....	(24)	■ <b>Troubleshooting</b> .....	(25)
I want to play audio from the TV with the amplifier connected to this unit.....	(24)	Power does not turn on / Power is turned off .....	(25)
I am not satisfied with the audio quality of the headphones connector on the TV .....	(24)	No sound comes out .....	(26)
I want to reduce power consumption .....	(24)	Sound is interrupted or noise occurs.....	(26)
		Files on my computer cannot be played back .....	(27)
		Audio from digital devices cannot be played (COAXIAL/OPTICAL-1/OPTICAL-2).....	(27)
		The input source does not switch .....	(27)



## Tips

### I want to play audio from the TV with the amplifier connected to this unit

- Connect the digital audio output connector on the TV to the digital audio input connector on this unit (COAXIAL, OPTICAL-1, or OPTICAL-2), and then switch the input source on this unit to the connector being used (COAXIAL, OPTICAL-1, or OPTICAL-2) ([🔍 page 14](#)).
- 2-channel linear PCM digital audio signals can be played back on this unit.

### I am not satisfied with the audio quality of the headphones connector on the TV

- Input audio from the TV to this unit, and connect the headphones to the headphones connector on this unit to enjoy high quality audio. Connect the digital audio output connector on the TV to the digital audio input connector on this unit (COAXIAL, OPTICAL-1, or OPTICAL-2), and then switch the input source on this unit to the connected connector (COAXIAL, OPTICAL-1, or OPTICAL-2) ([🔍 page 14](#)).
- 2-channel linear PCM digital audio signals can be played back on this unit.

### I want to reduce power consumption

- Set the Auto Standby mode to on ([🔍 page 22](#)).
- When not using this unit for a long time, disconnect the AC adapter from the power outlet.



## Troubleshooting

If a problem should arise, first check the following:

1. Are the connections correct?
2. Is the set being operated as described in the owner's manual?
3. Are the other devices operating properly?

If this unit does not operate properly, check the items listed in the table below. Should the problem persist, there may be a malfunction. In this case, disconnect the power immediately and contact your store of purchase.

### ■ Power does not turn on / Power is turned off

Symptom	Cause / Solution	Page
Power is not turned on.	<ul style="list-style-type: none"> <li>• Check whether the AC adapter is correctly inserted into the power outlet.</li> <li>• Check that this unit is connected to the AC adapter.</li> <li>• This unit is in standby mode. Press power operation button (⏻).</li> <li>• Use the AC adapter provided with this unit.</li> </ul>	<a href="#">12</a> <a href="#">12</a> <a href="#">14</a> <a href="#">12</a>
Power automatically turns off.	<ul style="list-style-type: none"> <li>• The Auto Standby mode is set. The Auto Standby mode switches the unit to standby mode when the unit is not operated for approximately 30 minutes. To disable the Auto Standby mode, press and hold the power operation button (⏻) for more than 5 seconds when the Auto Standby mode is enabled.</li> </ul>	<a href="#">22</a>



## ■ No sound comes out

Symptom	Cause / Solution	Page
No sound is produced or sound is distorted.	• Check the connections for all devices.	<u>11</u>
	• Insert connection cables all the way in.	–
	• Check cables for damage.	–
	• Check the amplifier input source and switch to the connector that is connected to this unit.	–
	• Check if the appropriate input source is selected.	<u>14</u>
	• The headphone volume is set to the minimum level. Adjust the volume level properly.	<u>14</u>

## ■ Sound is interrupted or noise occurs

Symptom	Cause / Solution	Page
Sound is interrupted during playback of tracks saved on a computer.	• Do not start applications other than the player software while playing music on your computer.	–



## ■ Files on my computer cannot be played

Symptom	Cause / Solution	Page
This unit is not recognized by my computer.	<ul style="list-style-type: none"> <li>• Check the OS of your computer.</li> <li>• When your computer is running on Windows, a dedicated driver software should be installed.</li> </ul>	<u>15</u> <u>15</u>
“Unlock” is displayed.	<ul style="list-style-type: none"> <li>• When digital audio signals cannot be detected properly, “Unlock” is displayed.</li> </ul>	<u>20</u>
“Unsupported” is displayed.	<ul style="list-style-type: none"> <li>• “Unsupported” is displayed when audio signals that are not supported by this unit are input. Check the settings on your computer or player software.</li> </ul>	<u>20</u> , <u>28</u>

## ■ Audio from digital devices cannot be played back (COAXIAL/OPTICAL-1/OPTICAL-2)

Symptom	Cause/Solution	Page
“Unlock” is displayed.	<ul style="list-style-type: none"> <li>• When digital audio signals cannot be detected properly, “Unlock” is displayed.</li> </ul>	<u>21</u>
“Unsupported” is displayed.	<ul style="list-style-type: none"> <li>• “Unsupported” is displayed when audio signals that are not supported by this unit are input. Check the audio output signal format from your digital device.</li> </ul>	<u>21</u> , <u>28</u>

## ■ The input source does not switch

Symptom	Cause/Solution	Page
The input source does not switch even when the input source select switch (⏮) is touched.	<ul style="list-style-type: none"> <li>• Touch the input source select switch (⏮) correctly with your finger.</li> </ul>	<u>14</u>



# Appendix

## Types of digital audio input signals available for playback

### Input signals available for USB-DAC playback

Types of input signals available for playback	Input signal specifications
DSD (2-channel)	<ul style="list-style-type: none"> <li>• Sampling frequency : 2.8224/5.6448 MHz</li> <li>• Bit length : 1 bit</li> <li>• Transmission system : Native/DoP</li> </ul>
Linear PCM (2-channel)	<ul style="list-style-type: none"> <li>• Sampling frequency : 32/44.1/48/88.2/96/176.4/192 kHz</li> <li>• Bit length : 16/24 bit</li> </ul>

### Input signals available for COAXIAL/OPTICAL-1/OPTICAL-2 playback

Types of input signals available for playback	Input signal specifications
Linear PCM (2-channel)	<ul style="list-style-type: none"> <li>• Sampling frequency : 32/44.1/48/64/88.2/96/176.4/192 kHz</li> <li>• Bit length : 16/24 bit</li> </ul>



## Explanation of terms

---

### A

#### **Advanced AL32 Processing**

Equipped with Advanced AL32 Processing, Denon's own analog waveform reproduction technology.

The reproducibility of weak signals is enhanced by expanding 16 bit digital data to 32 bit.

### D

#### **DSD (Direct Stream Digital)**

This is a digital audio recording technology used for Super Audio CD. This enables recording and playback of audio very close to the original, allowing you to enjoy high quality audio.

#### **Dynamic range**

The difference between the maximum, undistorted sound level and the minimum sound level that is discernible above the noise emitted by the device.

### L

#### **Linear PCM**

This is an uncompressed PCM (Pulse Code Modulation) signal. Unlike lossy compression audio sources such as MP3, the audio quality and dynamic range are not reduced.

### S

#### **Sampling frequency**

Sampling involves taking a reading of a sound wave (analog signal) at regular intervals and expressing the height of the wave at each reading in digitized format (producing a digital signal).

The number of readings taken in one second is called the "sampling frequency". The larger the value, the closer the reproduced sound is to the original.



## Trademark information

---



Adobe, the Adobe logo and Reader are either registered trademarks or trademarks of Adobe Systems Incorporated in the United States and/or other countries.



# Specifications

## ■ Audio performance

### • Analog output

**Channels:**

**Playable frequency range:**

**Playable frequency response:**

**S/N:**

**Dynamic range:**

**Harmonic distortion:**

**Output level:**

**Sampling frequency:**

### [DSD signal]

2 channels

2 Hz – 100 kHz

2 Hz – 50 kHz (–3 dB)

112 dB (Audible range)

105 dB (Audible range)

0.0018 % (1 kHz, Audible range)

2.0 V (10 k $\Omega$ /kohms)

2.8224/5.6448 MHz

### [PCM signal]

2 channels

2 Hz – 96 kHz

2 Hz – 20 kHz ( $\pm 0.5$  dB)

112 dB

105 dB

0.0018 % (1 kHz)

2.0 V (10 k $\Omega$ /kohms)

32/44.1/48/64/88.2/96/176.4/192 kHz

### • Digital input

**Format:**

**Coaxial:**

**Optical:**

**Emission wavelength:**

Digital audio interface (Linear PCM)

0.5 Vp-p / 75  $\Omega$ /ohms

–27 dBm or later

660 nm

## ■ General

**AC adapter:**

Input : 100 – 240 V, 50/60 Hz

Output : DC 15 V, 1 A

For purposes of improvement, specifications and design are subject to change without notice.



# Index

## A

Accessories .....	3
Adjusting the volume .....	14
Advanced AL32 Processing .....	29
Auto Standby mode .....	22

## C

Cables used for connections .....	8
Computer .....	15
Connection	
AC adapter .....	12
Amplifier .....	11
CD player .....	11
Computer .....	11
Satellite tuner .....	11
TV .....	11

## D

Display .....	6
DSD .....	20, 28, 29
Dynamic range .....	29

## F

Feet for horizontal placement .....	9
Front Panel .....	5

## H

Headphone .....	14
-----------------	----

## I

Installing the driver software .....	15
--------------------------------------	----

## L

Linear PCM .....	20, 21, 28, 29
------------------	----------------

## P

Playback	
Computer (USB-DAC) .....	15
Digital device .....	21
Player software .....	15

## R

Rear panel .....	7
------------------	---

## S

Sampling frequency .....	28, 29
Selecting the input source .....	14
Stand for vertical placement .....	10

## T

Tips .....	24
Troubleshooting .....	25
Turning the power on .....	14



## ■ Dimensions

Unit : in. (mm)

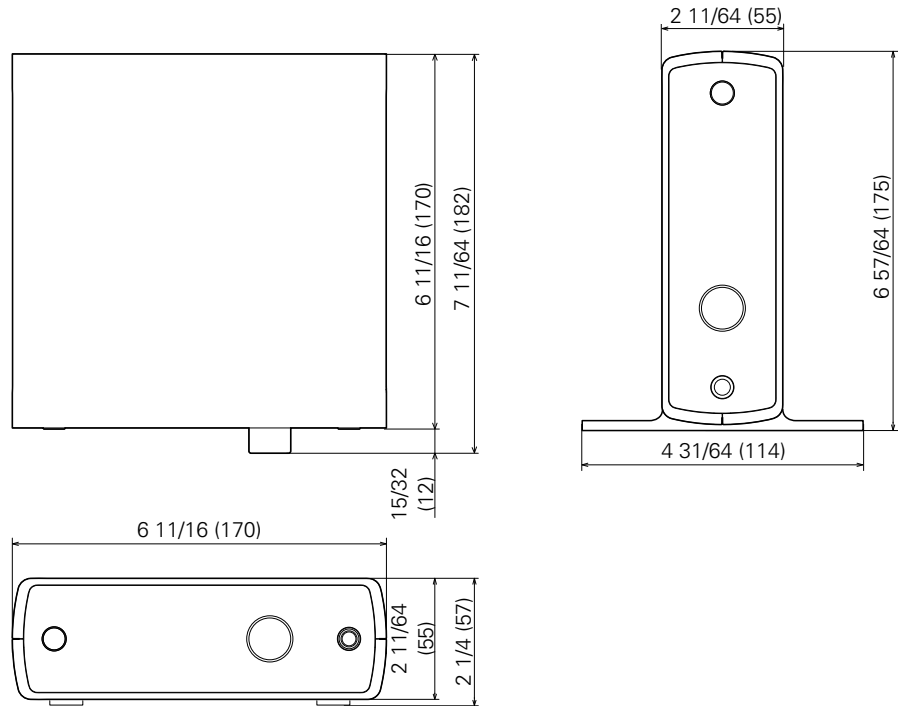

## ■ Weight : 3 lbs 5 oz (1.5 kg)



**DENON**

[www.denon.com](http://www.denon.com)

D&M Holdings Inc.  
3520 10323 00AD

