

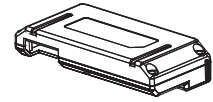

Yale *real* Living

Yale® Assure Lock® SL  
Key Free Touchscreen Deadbolt  
Installation and Programming Instructions  
(YRD256/YRD456)

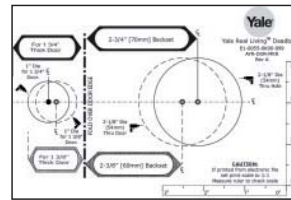

Optional Network Module

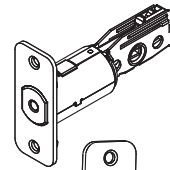
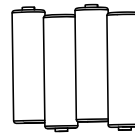
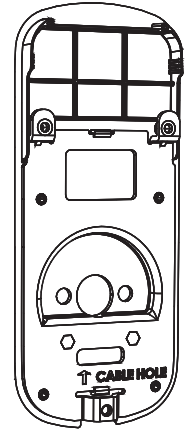
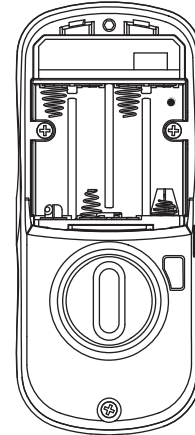
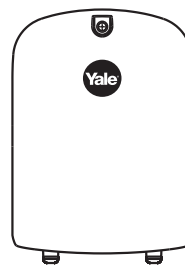

**x3**  
#8-32 x 5/16"  
Machine screws



**x4**  
#7 wood & #8-32  
machine x 20mm  
Combination screws



**x2**  
M6x36mm  
PPHMS  
(1-3/8")

**OR**



**x2**  
M6x44mm  
PPHMS  
(1-3/4-2")

**OR**



**x2**  
M6x55mm  
PPHMS  
(2-1/4")

**Before you begin**

**DOWNLOAD THE BILT APP**

for step-by-step installation instructions & to register your product



**BILT.**



FAILURE TO FOLLOW THESE INSTRUCTIONS COULD RESULT IN DAMAGE TO THE PRODUCT AND VOID THE FACTORY WARRANTY





# Preparing Door

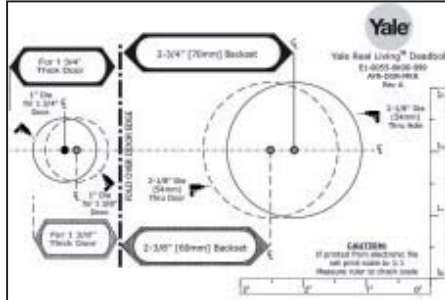

 Refer to template for correct door prep

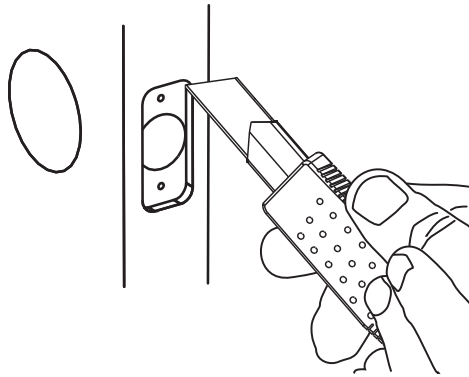

# 1

## Installing Latch & Strike Plate



x4

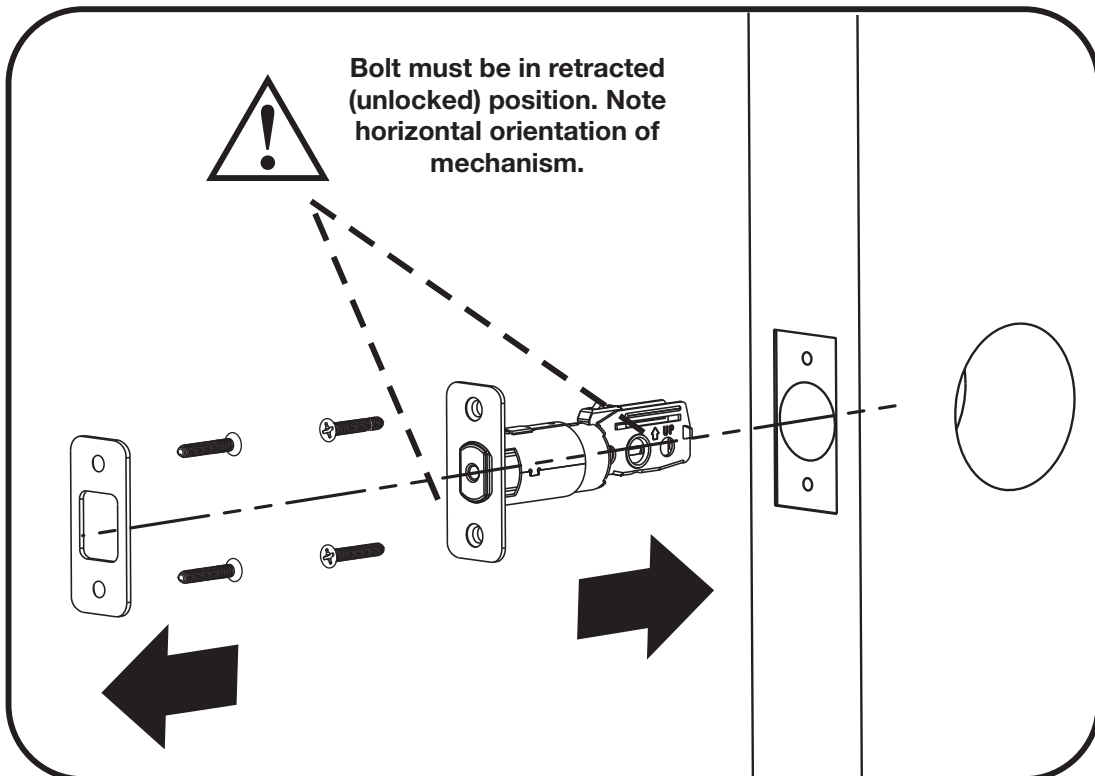
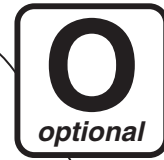
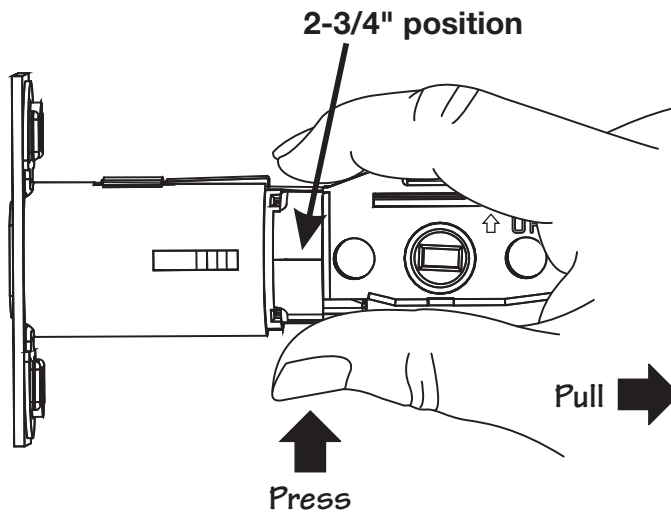
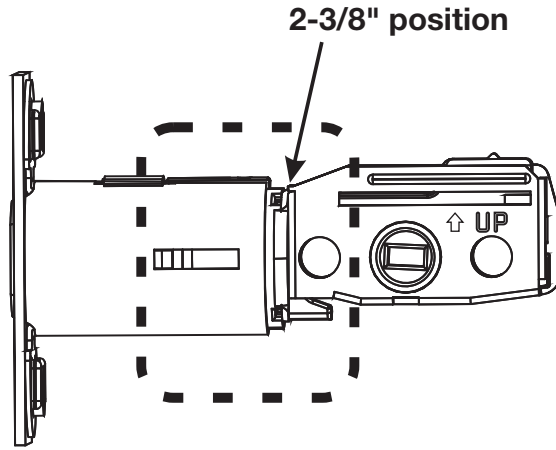

# 2

## Installing Touchscreen Escutcheon

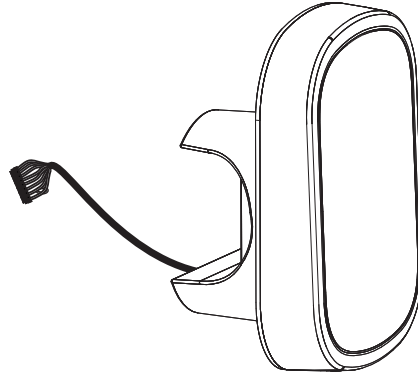

Inside of Door

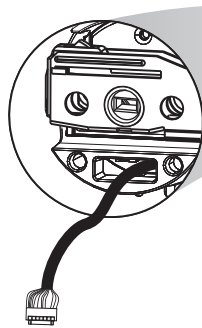

Outside of Door

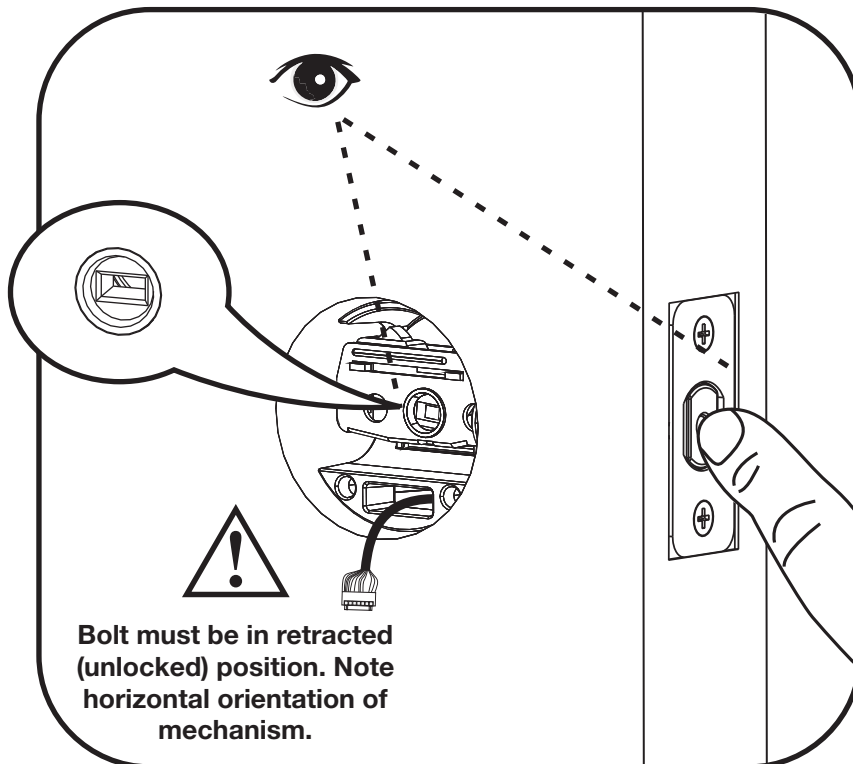
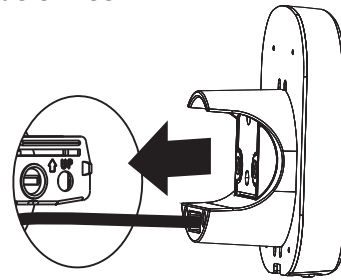

# 3

## Installing Interior Mounting Plate

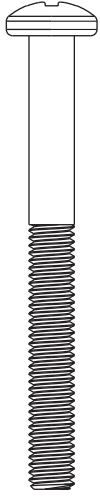

x2

Loosen screw to remove cover.

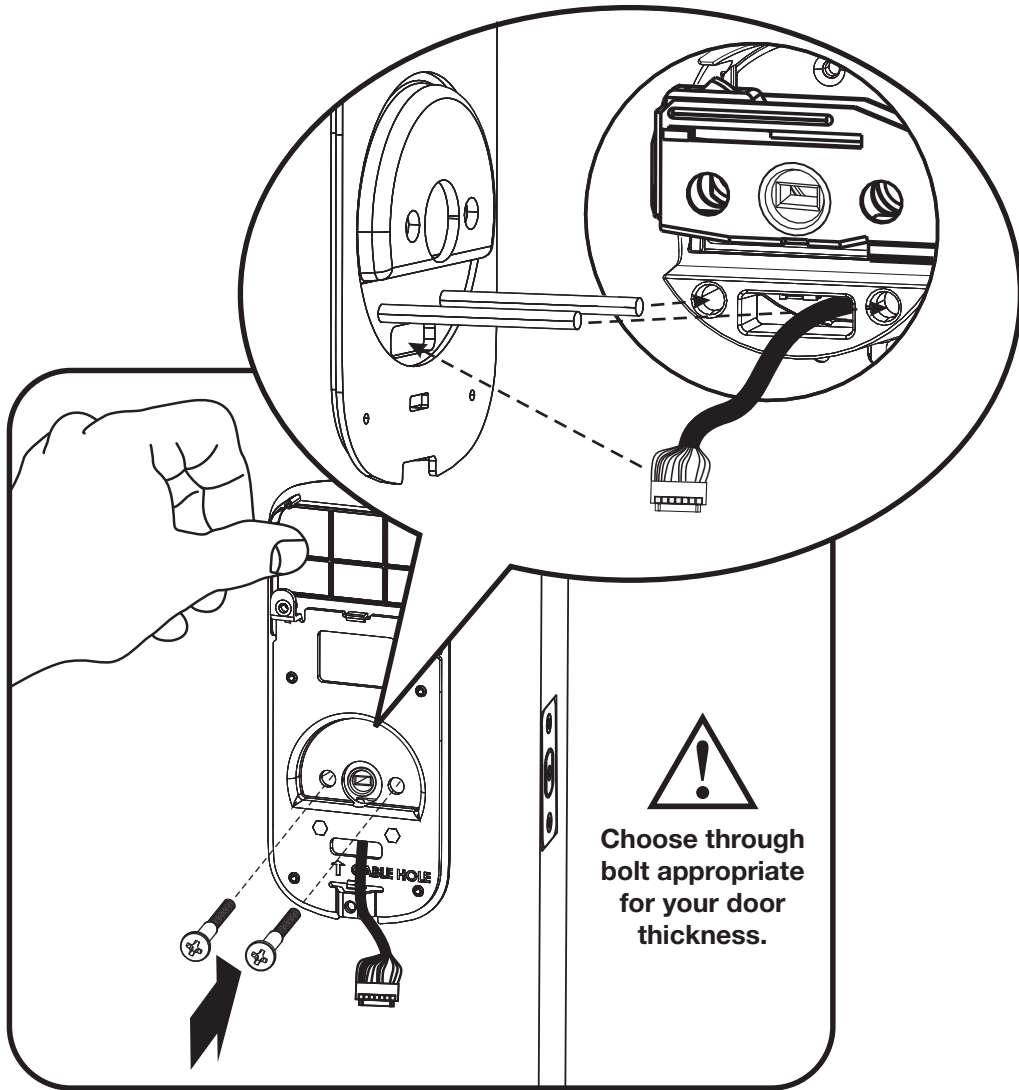
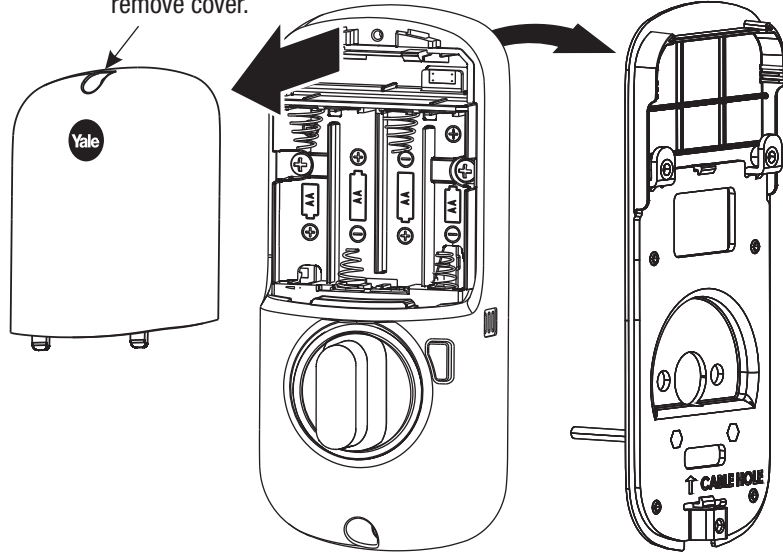

# 4

## Attaching the Cable Assembly

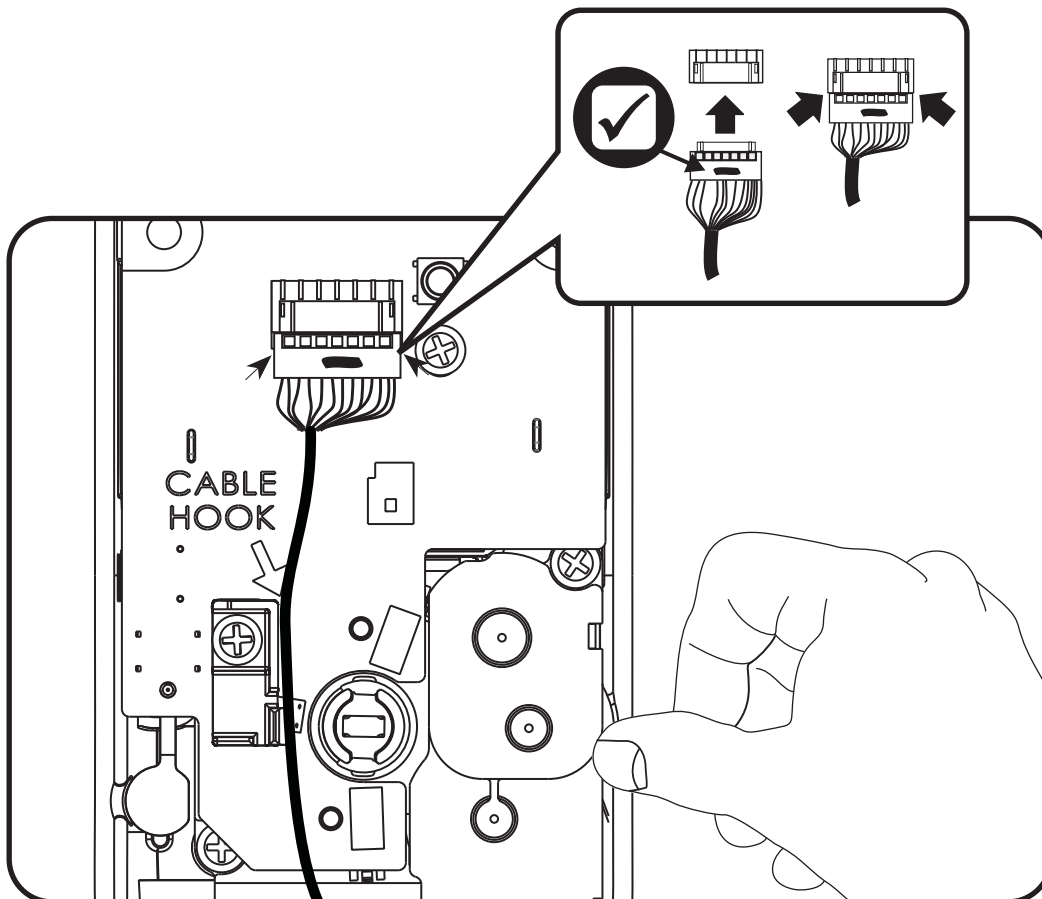
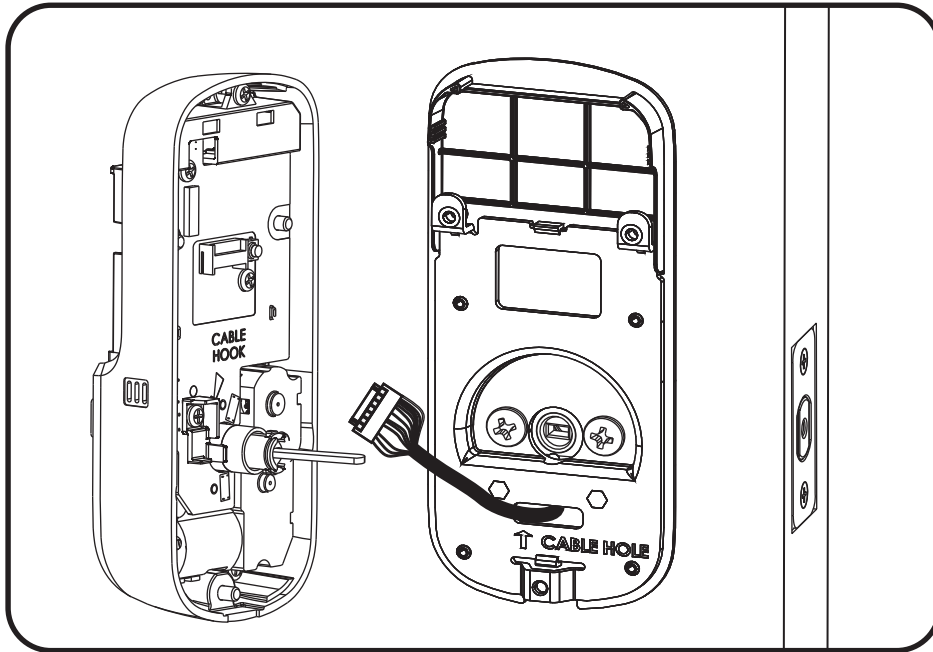

# 5

## Installing Interior Escutcheon



x3

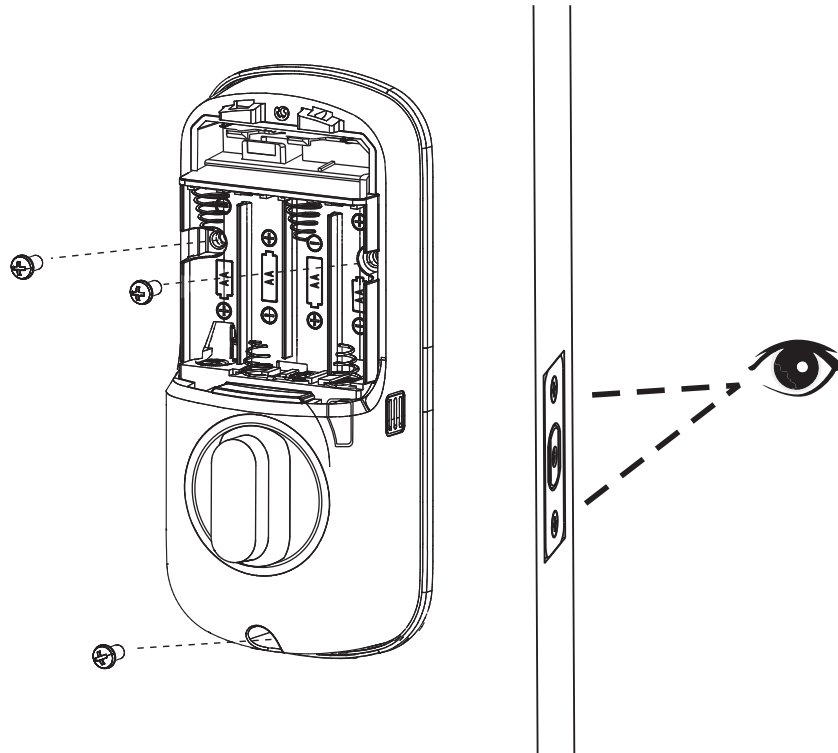
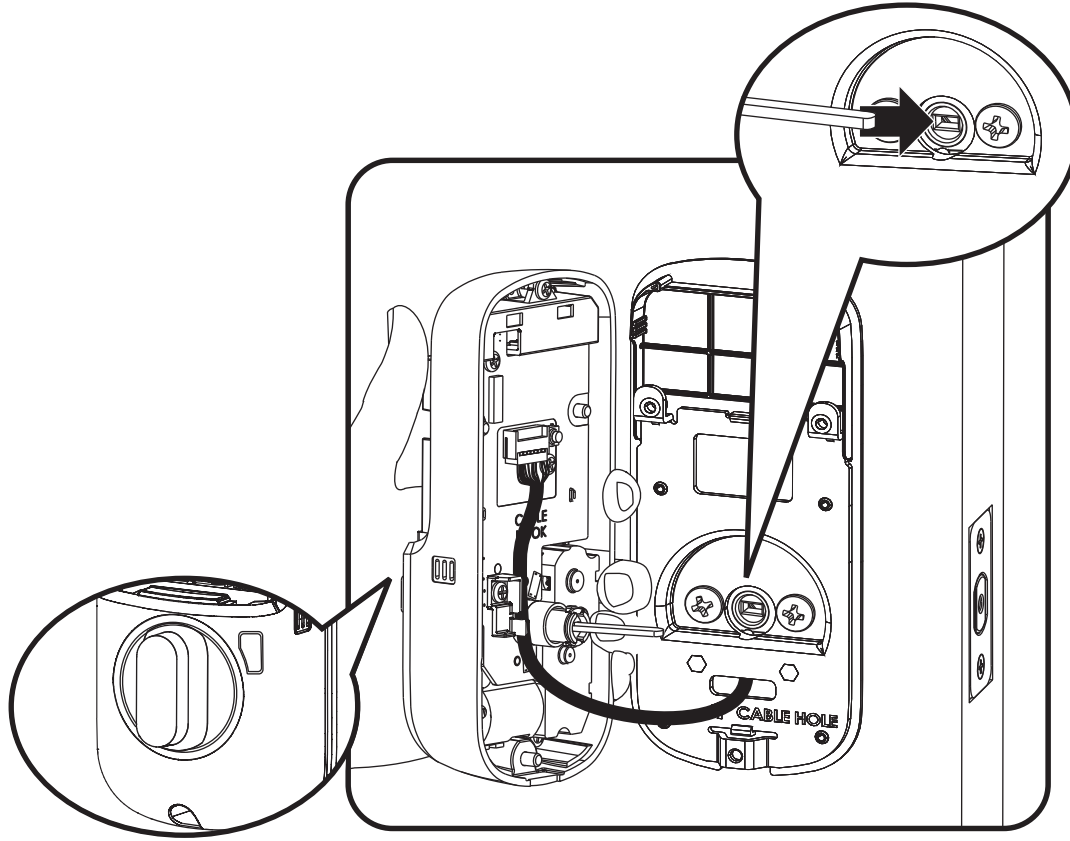



# Testing Operation

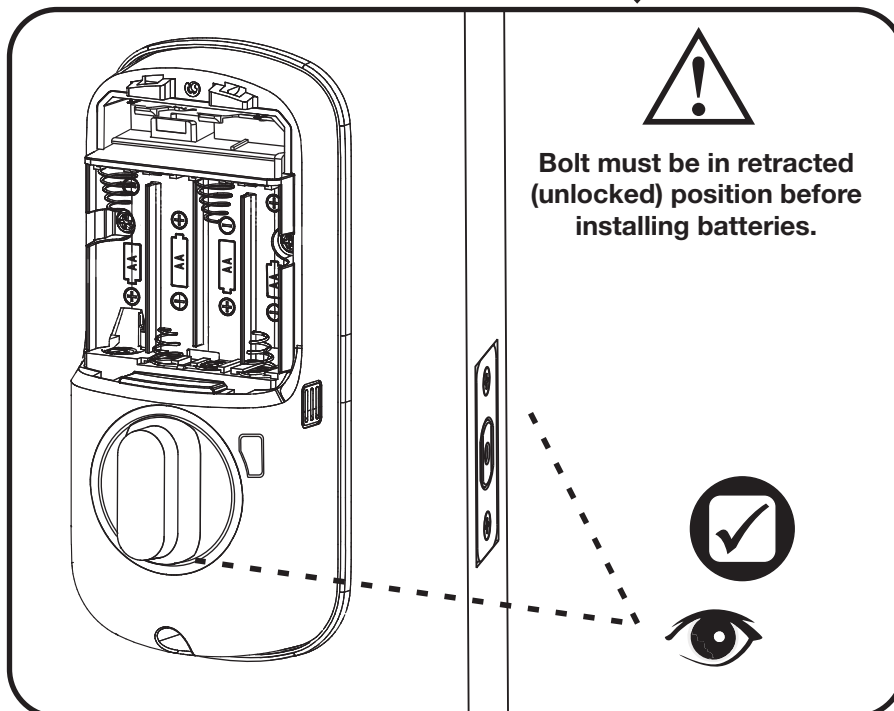
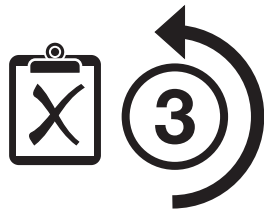
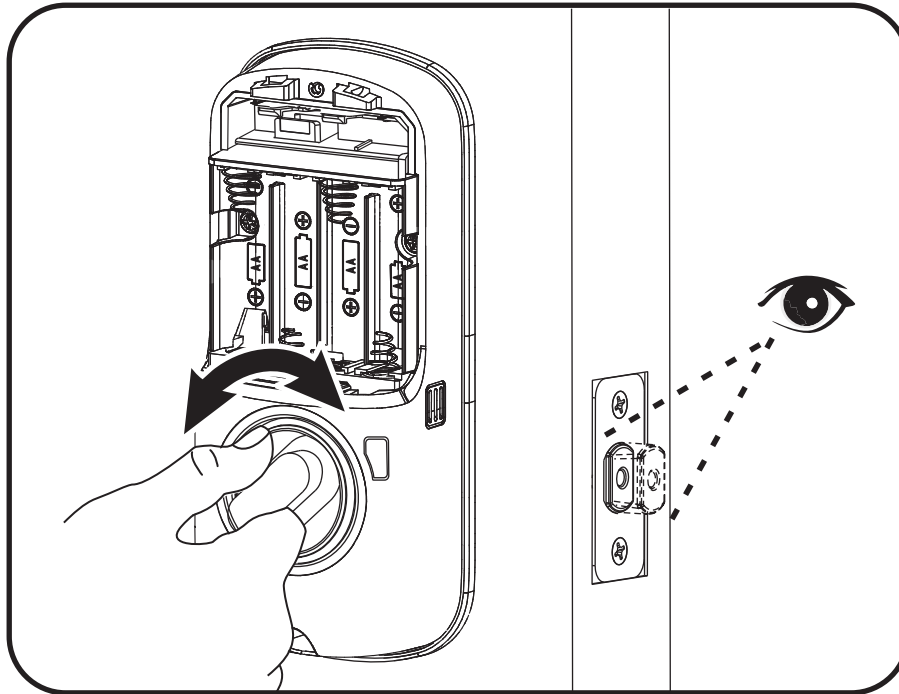

# 6

## Installing Batteries/Handing the Lock

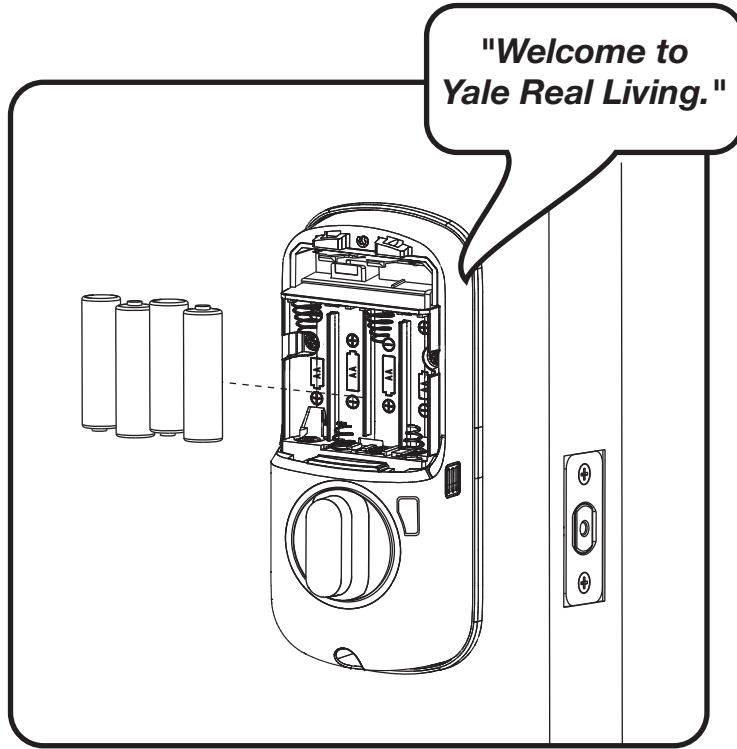

Lock automatically adjusts for proper handing.

# 7

## Installing Optional Network Module

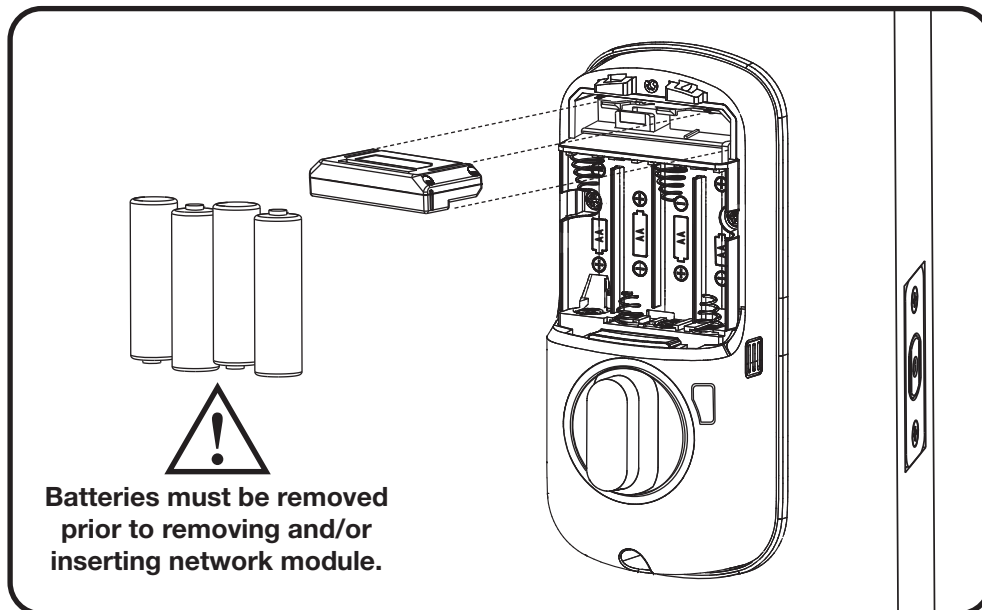

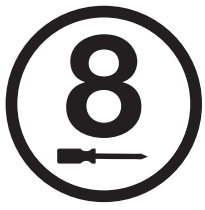

## Installing Cover

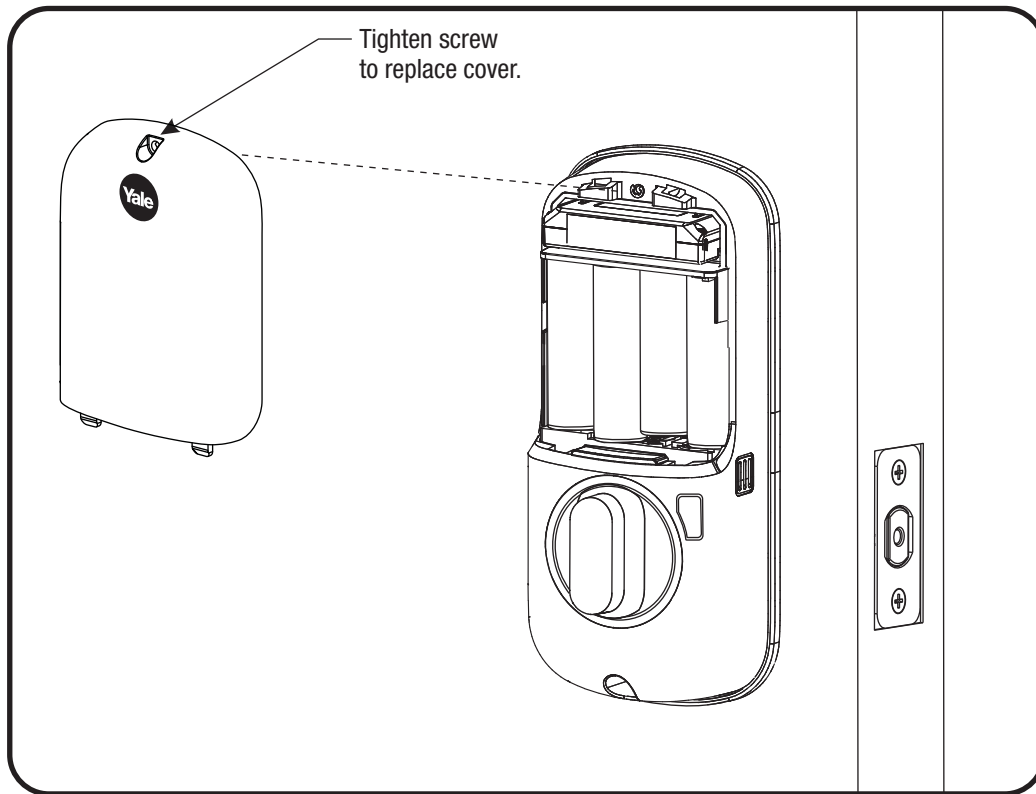

Congratulations, you've installed the Yale® Assure Lock® SL  
Key Free Touchscreen Deadbolt (YRD256/YRD456)!  
Continue to Programming Instructions  
to customize your product.

# Programming Instructions

## Exterior Escutcheon

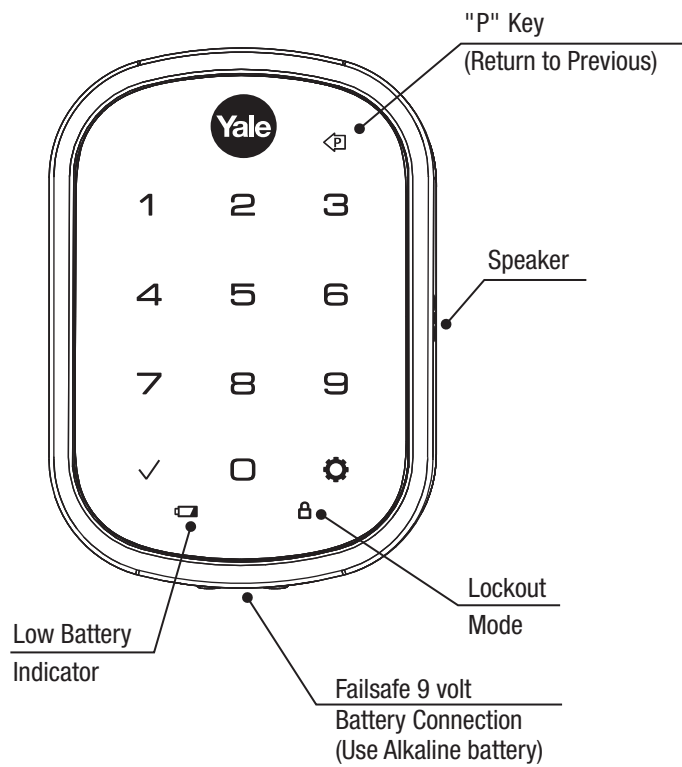

## Interior Escutcheon

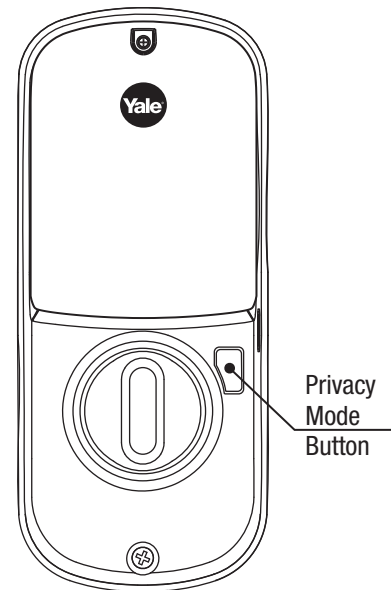

## Lock Activation

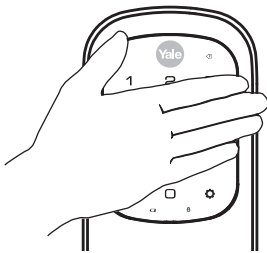

**OR**

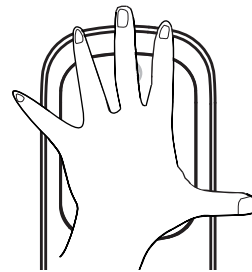

Master PIN Code must be created before any further programming.  
Max User Codes = 250 with Z-Wave Plus or ZigBee network module  
Max User Codes = 25 without network module or with iM1 network module  
Max User Codes - 12 with Bluetooth



# 1

## Creating Master PIN Code

Creating a Master PIN Code must be performed upon installation or after resetting the lock to factory default. Programming and use of lock is not possible until this step has been successfully completed.

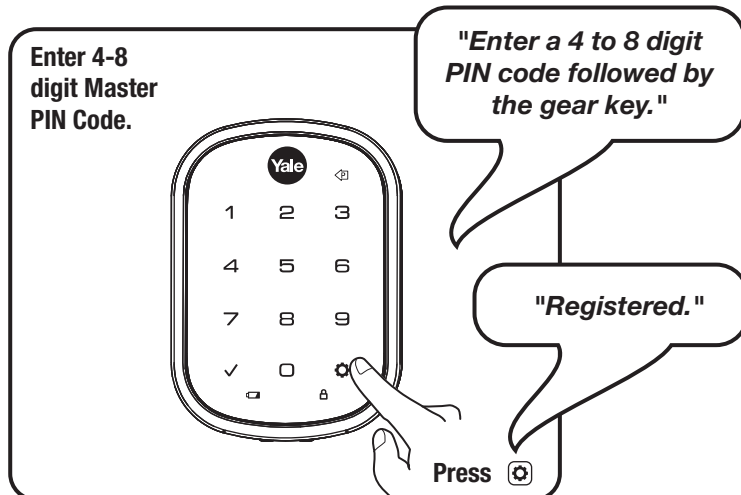
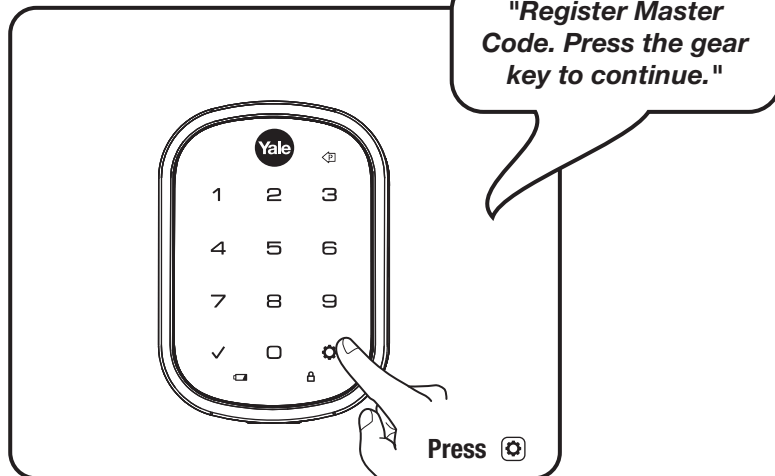
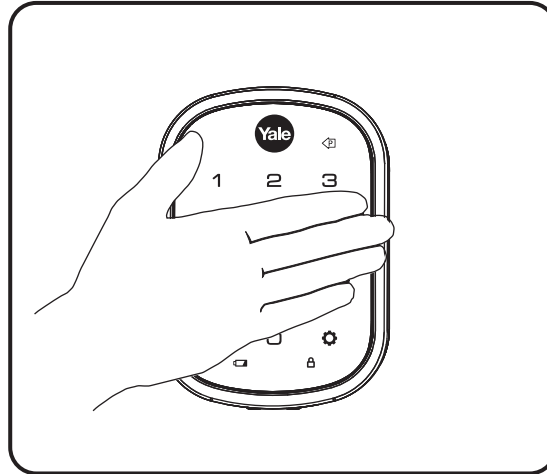

# 2

## Creating User PIN Codes

Master PIN code must be created first.

\*Max user codes = 250 with Z-Wave Plus or ZigBee network module

Max user codes = 25 without network module or with iM1 network module

Max user codes = 12 with Bluetooth

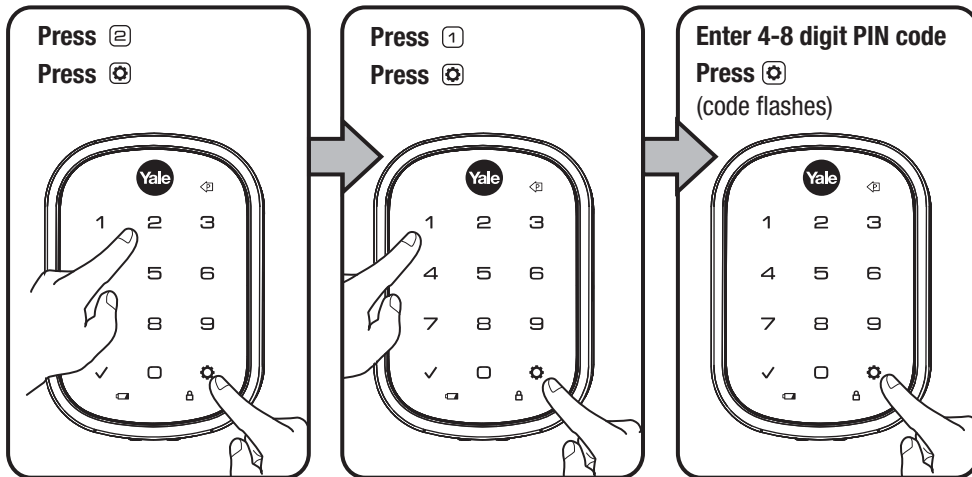
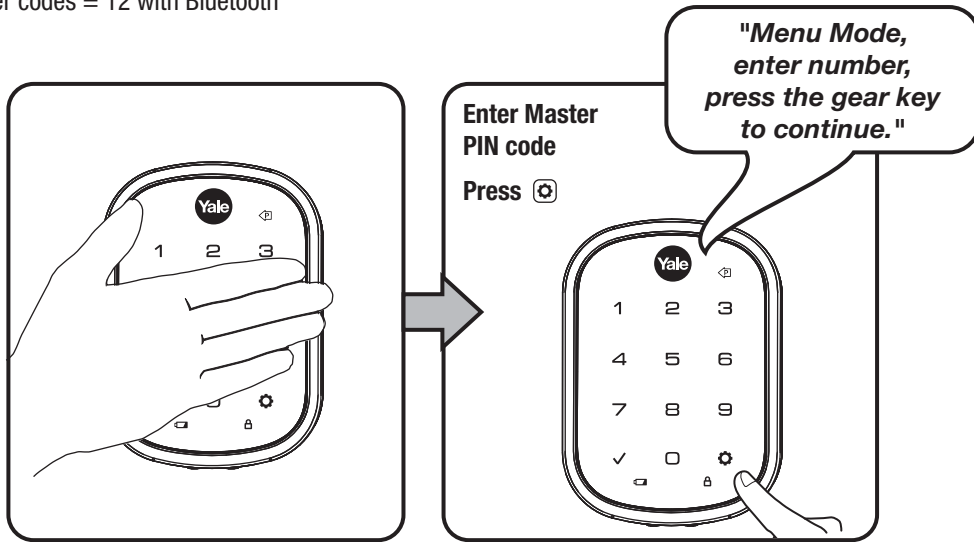

Adding more \*User Codes:

To end programming:

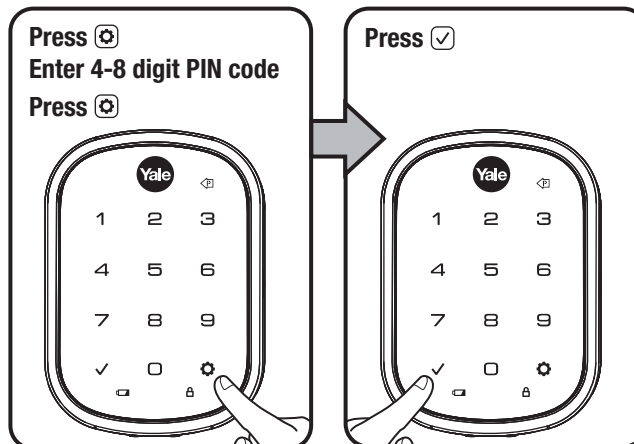



# Resetting Lock to Factory Default

When lock is reset to factory defaults all user codes (including the Master PIN code\*) are deleted and all programming features are reset to original default settings (see below).

1. Remove the battery cover and batteries.
2. Remove the interior escutcheon to access the reset button.
3. The reset button (see image at right) is located beside the PCB cable connector.
4. While pressing the reset button (minimum of 3 seconds) reinstall batteries. Release reset button.
5. Replace battery cover.

Upon reset, Master PIN Code creation is the only option available and must be performed prior to any other programming of the lock.

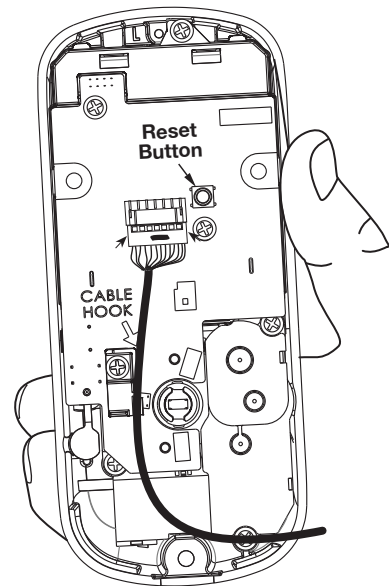

**Interior Escutcheon**

## Factory Settings

Settings	Factory Setting
Master PIN Code	Registration <i>required</i> *
Automatic Re-lock	Disabled
Inside Indicator Light	Disabled (Off)
One Touch Locking	Enabled
Privacy Button Setting	Disabled
Volume Setting	Enabled (Low)
Language Setting	English
Lockout Mode	Disabled
Automatic Re-lock Time	30 Seconds
Wrong Code Entry Limit	5 Times
Shutdown Time	60 Seconds

\*The Master PIN code must be registered prior to any other programming of the lock.



# Definitions

**All Code Lockout Mode:** This feature is enabled by the Master code. When enabled, it restricts all user (except Master) PIN code access. When attempting to enter a code while the unit is in Lockout, the RED locked padlock will appear on the screen.

**Automatic Re-lock Time:** After a successful code entry and the unit unlocks, it will automatically re-lock after thirty (30) seconds.

**Inside Indicator Light:** Located on the interior escutcheon. Shows active status (Locked) of lock and can be enabled or disabled in the **Advanced Lock Settings** (Main Menu selection #3).

**Language Setting Mode:** Choosing English (1), Spanish (2) or French (3) becomes the (default) setting for the lock's voice prompts.

**Low Battery:** When battery power is low, the Low Battery Warning indicator flashes RED. If battery power is completely lost, use the 9Volt battery override. To use the 9V battery override apply 9V battery, in either direction, to terminals below the touchscreen for backup power option. Wake up the lock and enter your pin code to unlock the door.

**Master PIN Code:** The Master PIN code is used for programming and for feature settings. **It must be created prior to programming the lock.** The Master code will also operate (unlock/lock) the lock.

**Network Module Setting:** With the optional Network Module installed, this setting becomes available thru the Main Menu (7) and allows the lock to connect with a network controller.

**One Touch Locking:** When the latch is retracted, activating the keypad will extend the latch (during Automatic Re-lock duration or when Automatic Re-lock is disabled). When One-Touch Re-lock is **not** in use (**disabled**), any valid PIN code will re-lock the lock.

**Previous:** While in Menu Mode, pressing this icon cancels the current operation and returns the user to the previous step.

**Privacy Mode:** Privacy mode is disabled by default. Enable Privacy mode by pressing the privacy button for 4 seconds to put the lock in do-not-disturb mode (all pin codes are disabled).

**Shutdown Time:** The unit will shutdown (flashing RED) for sixty (60) seconds and not allow operation after the wrong code entry limit (5 attempts) has been met.

**Tamper Alert:** Audible alarm sounds if attempting to forcibly remove outside lock from door.

**User PIN Code:** The user code operates the lock. The maximum number of user codes with Z-Wave Plus or ZigBee network module is 250; without network module or with iM1 network module, maximum is 25; with Bluetooth, maximum is 12. Note: When deleting user pin code(s), screen will display user pin code being deleted.

**Volume Setting Mode:** The volume setting for PIN code verification is set to **Low (2)** by default; otherwise it can be set to **High (1)** or **Silent (3)** for quiet areas.

**Wrong Code Entry Limit:** After five (5) unsuccessful attempts at entering a valid PIN code, the unit will shut down and not allow operation.







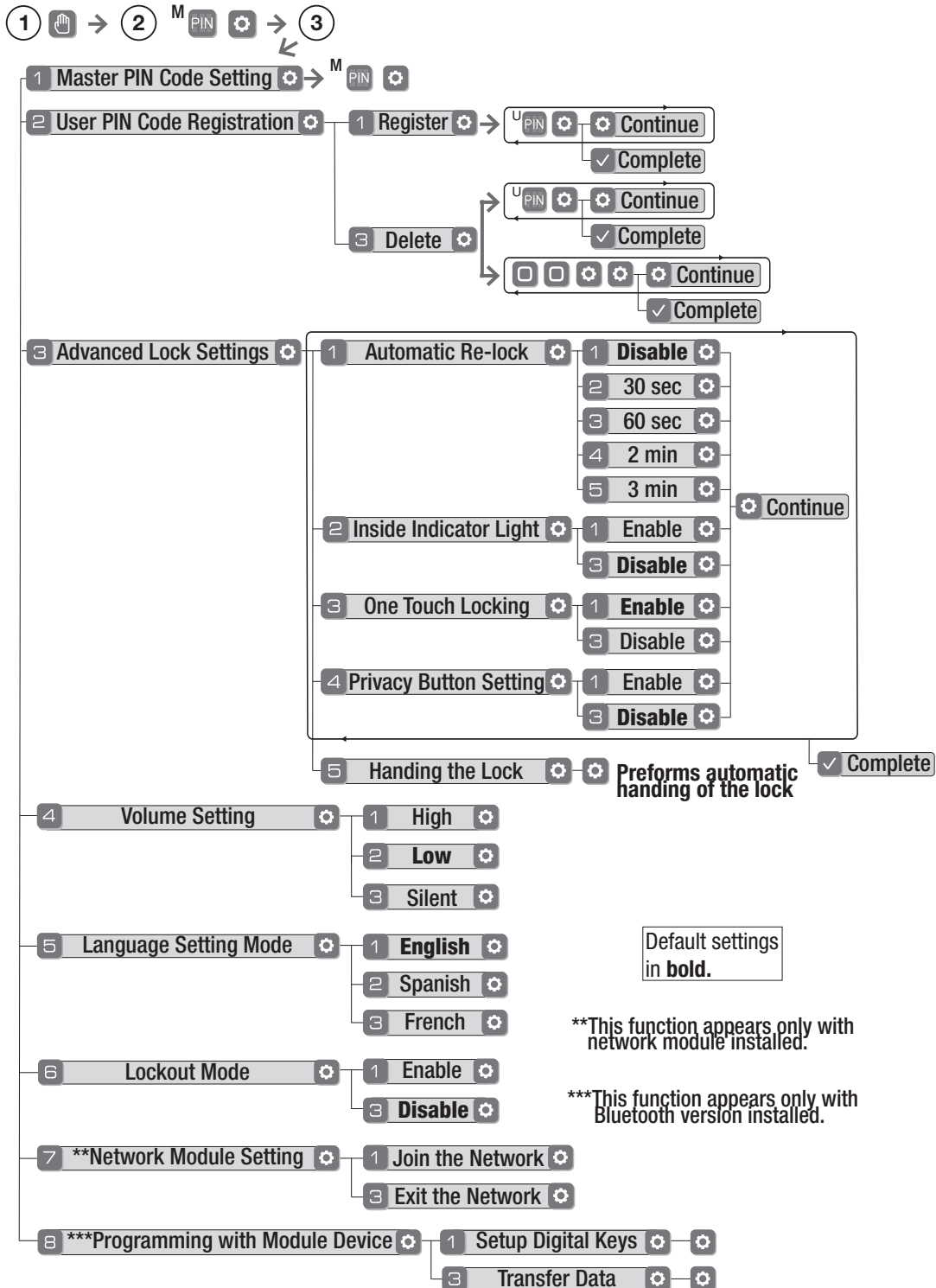

# Feature Programming Through Menu Mode Using Master PIN code\*

1. Touch screen with back of hand or palm to activate.
2. Enter 4-8 digit master PIN code\* followed by key.  
Lock Response: "Menu mode, enter number, press key to continue."
3. Enter digit corresponding to the function to be performed followed by the key.  
Follow the voice commands.

\*The Master PIN code must be registered prior to any other programming of the lock.



# Programming Troubleshooting

Symptom	Suggested Action
Lock does not respond – door is open and accessible.	<ul style="list-style-type: none"> <li>• Touchscreen becomes active when pressed w/whole hand. Use a larger area of the hand or fingers and verify contact with at least 3 areas.</li> <li>• If touchscreen numbers are visible, check to see if they respond when pressed.</li> <li>• Check batteries are installed and oriented correctly (polarity) in the battery case.</li> <li>• Check batteries are in good condition; replace batteries* if discharged.</li> <li>• Check to see if touchscreen harness is fully connected and not pinched.</li> </ul>
Lock does not respond – door is locked and inaccessible.	<ul style="list-style-type: none"> <li>• Batteries may be completely discharged.</li> <li>• Apply 9V battery to terminals below the touchscreen for backup power option.</li> </ul>
Unit is on for a while then shows no reaction. Lights dim.	<ul style="list-style-type: none"> <li>• Batteries do not have enough power. Replace batteries*.</li> </ul>
Unit chimes to indicate code acceptance, but the door will not open.	<ul style="list-style-type: none"> <li>• Check the door gaps for any foreign objects between door and frame.</li> <li>• Check that the wire harness is firmly connected to the PCB.</li> </ul>
Unit operates to allow access, but will not automatically re-lock.	<ul style="list-style-type: none"> <li>• Check to see if Auto Re-lock Mode is enabled.</li> <li>• Disable Auto Re-lock Mode to lock the door (automatically).</li> <li>• If low battery indicator is lit (see below), change batteries*.</li> </ul>
PIN codes will not register.	<ul style="list-style-type: none"> <li>• PIN codes must consist of 4 to 8 digits to register.</li> <li>• The same PIN code cannot be used for multiple users.</li> <li>• Registration/management of PIN codes is set by the authority of the Master Code, which is set first.</li> <li>• Contact the Master user.</li> <li>• User codes must be entered within 5 seconds (while touchscreen is active) or process will have to be restarted.</li> <li>• Check  or gear  cannot be used as part of the PIN code.</li> </ul>
Upon entering a PIN code and pressing  key, the unit displays "invalid code" error or lock times out without responding.	<ul style="list-style-type: none"> <li>• Lockout Mode is enabled.</li> <li>• Only the Master can enable/disable Lockout Mode.</li> <li>• Contact the Master user.</li> </ul>
Upon entering a PIN code and pressing the  key, the red padlock icon appears and there are different tones.	<ul style="list-style-type: none"> <li>• Check to see if the lock is set to Lockout Mode.</li> <li>• Setting/managing Lockout Mode is done through Master Code only. Contact the Master user.</li> </ul>
The unit operates, but it makes no sound.	<ul style="list-style-type: none"> <li>• Check to see if Silent Mode is enabled (see Feature #4).</li> </ul>
The unit responds "Low Battery"	<ul style="list-style-type: none"> <li>• This is the alert to replace the batteries. Replace all four (4) batteries* with new AA Alkaline batteries.</li> </ul>
Upon entering a PIN code and pressing the  key, the unit responds "Wrong number of digits".	<ul style="list-style-type: none"> <li>• The digits entered were incorrect or incomplete. Re-enter the correct code followed by the check  key.</li> </ul>

\* When batteries are replaced, Network Module locks have a real time clock that will be set through the User Interface (UI); it is recommended to verify correct date and time particularly those locks operating under Daylight Saving Time (DST).

\*\* Network Module locks only



# Hardware Troubleshooting

Cycle lock in both the locked and unlocked positions. If problems are found:

Door is binding

- Check that door and frame are properly aligned and door is free swinging.
- Check hinges: They should not be loose or have excessive wear on knuckles.

Bolt will not deadlock

- Check for sufficient clearance of the bolt within the strike-side jamb. Correct this by increasing the depth of the pocket for the bolt.
- Check for misalignment of bolt and/or strike which may be preventing bolt from properly entering the strike. With the door open, extend and retract the bolt; if it is smooth, check the strike alignment.

Bolt does not extend or retract smoothly

- Bolt and strike are misaligned, see above.
- Check the backset of door relative to adjustments already made to bolt.
- Verify proper door preparation and re-bore holes that are too small or misaligned.
- Verify keypad wire harness is routed under the bolt (see Fig. A).
- Verify bolt is installed with correct side up (Fig. A).

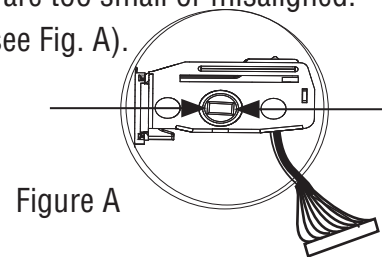

Keypad numerics are scrolling

Remove interior escutcheon and check to ensure that the wire harness lies flat against the back recessed area and is properly routed along the side of the escutcheon and tucked under the plastic cable guide.

## NOTE TO INSTALLER AND CONSUMER

While Yale<sup>®</sup> has included several features to prevent lockout (9-Volt battery jumper, low battery warnings), it is still possible for a lockout situation to occur. Because this product does not have a mechanical override (a key), Yale<sup>®</sup> recommends to use this product in an environment where there are additional entry points into the dwelling.

**FCC:***Class B Equipment*

This equipment has been tested and found to comply with the limits for a Class B digital device, pursuant to Part 15 of the FCC Rules. These limits are designed to provide reasonable protection against harmful interference in a residential installation. This equipment generates, uses, and can radiate radio frequency energy and, if not installed and used in accordance with the instructions, may cause harmful interference to radio communications. However, there is no guarantee that interference will not occur in a particular installation. If this equipment does cause harmful interference to radio or television reception, which can be determined by turning the equipment off and on, the user is encouraged to try to correct the interference by one or more of the following measures:

- Reorient or relocate the receiving antenna.
- Increase the separation between the equipment and receiver.
- Connect the equipment into an outlet on a circuit different from that to which the receiver is connected.
- Consult the dealer or an experienced radio/TV technician for help.

**Warning:** Changes or modifications to this device, not expressly approved by **Yale Security Inc.** could void the user's authority to operate the equipment.

**Industry Canada:**

This Class A digital apparatus meets all requirements of the Canadian Interference Causing Equipment Regulations.

Cet appareillage numérique de la classe A répond à toutes les exigences de l'interférence canadienne causant des règlements d'équipement.

## Yale Locks & Hardware

Product Support Tel 1-855-213-5841 • [www.yalehome.com](http://www.yalehome.com)

Yale Locks & Hardware is a division of Yale Security Inc., an ASSA ABLOY Group company.

Yale®, Yale Real Living® and Assure Lock® are registered trademarks of Yale Security Inc., an ASSA ABLOY Group Company.

Other products' brand names may be trademarks or registered trademarks of their respective owners and are mentioned for reference purposes only. Copyright © 2018, Yale Security Inc., an ASSA ABLOY Group Company. All rights reserved.

Reproduction in whole or in part without the express written permission of Yale Security Inc. is prohibited.

**YALE**, with its unique global reach and range of products, is the world's favorite lock –the preferred solution for securing your home, family and personal belongings.

**ASSA ABLOY** is the global leader in door opening solutions, dedicated to satisfying end-user needs for security, safety and convenience.



## Installing the Z-Wave® Plus Module

**IMPORTANT:** the batteries must be removed prior to removing and/or inserting the network module:



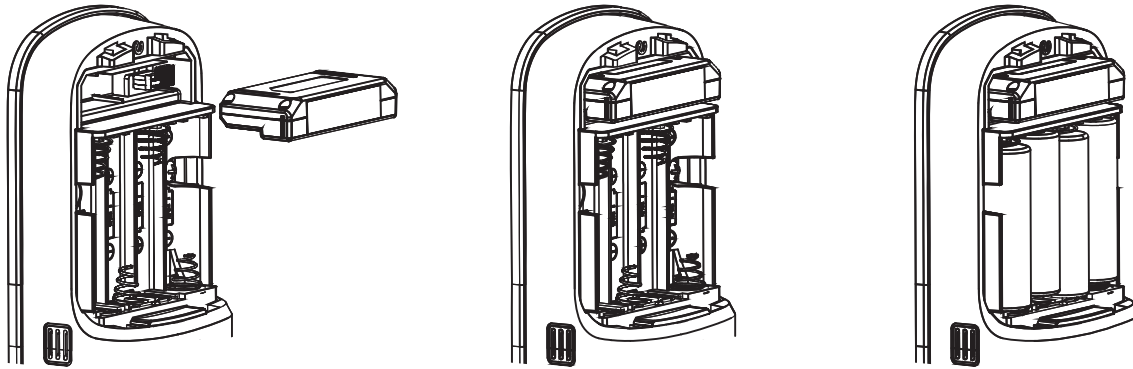
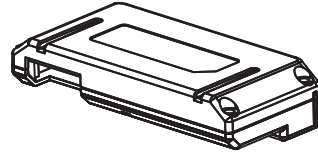

- Remove battery cover and batteries.
- Remove and/or insert Network Module.
- Reinstall batteries and battery cover.







## Enrolling/Unenrolling the Network Module:

This device is a security enabled Z-Wave Plus product that is able to use encrypted Z-Wave Plus messages to communicate to other security enabled Z-Wave Plus products. This device must be used in conjunction with a Security Enabled Z-Wave Controller in order to fully utilize all implemented functions. This product can be operated in any Z-Wave network with other Z-Wave certified devices from other manufacturers. All non-battery operated nodes within the network will act as repeaters regardless of vendor to increase reliability of the network.

To Enroll/Add the Module (Inclusion Mode):

- Enter the 4-8 digit Master PIN code followed by the  key.
- Press the  key followed by the  key.
- Press the  key followed by the  key.

To Unenroll/Remove the Module (Exclusion Mode):

- Enter the 4-8 digit Master PIN code followed by the  key.
- Press the  key followed by the  key.
- Press the  key followed by the  key.

Factory Reset - If No Controller:

- See the Lock Installation Manual
- Please use this procedure only when the network primary controller is missing or otherwise inoperable.

For System Integrators: Specific Z-Wave Plus association and parameter information for your lock is available at [YaleHome.com/ZwavePlus](http://YaleHome.com/ZwavePlus).



**Warning:** Changes or modifications to this device, not expressly approved by Yale Security Inc. could void the user's authority to operate the equipment.

#### **FCC:**

Contain FCC ID: U4A-YRHCPZWOFM

Model: YRMZW2-US

This equipment has been tested and found to comply with the limits for a Class B digital device, pursuant to Part 15 of the FCC Rules. These limits are designed to provide reasonable protection against harmful interference in a residential installation. This equipment generates, uses, and can radiate radio frequency energy and, if not installed and used in accordance with the instructions, may cause harmful interference to radio communications. However, there is no guarantee that interference will not occur in a particular installation. If this equipment does cause harmful interference to radio or television reception, which can be determined by turning the equipment off and on, the user is encouraged to try to correct the interference by one or more of the following measures:

- Reorient or relocate the receiving antenna.
- Increase the separation between the equipment and receiver.
- Connect the equipment into an outlet on a circuit different from that to which the receiver is connected.
- Consult the dealer or an experienced radio/TV technician for help.

THIS DEVICE COMPLIES WITH PART 15 OF THE FCC RULES. OPERATION IS SUBJECT TO THE FOLLOWING TWO CONDITIONS.

(1) THIS DEVICE MAY NOT CAUSE HARMFUL INTERFERENCE, AND (2) THIS DEVICE MUST ACCEPT ANY INTERFERENCE RECEIVED, INCLUDING INTERFERENCE THAT MAY CAUSE UNDESIRE OPERATION.

Industry Canada:

Contain IC: 6982A-YRHCPZWOFM

Model: YRMZW2-US

**Section 7.1.2 of RSS-GEN** Under Industry Canada regulations, this radio transmitter may only operate using an antenna of a type and maximum (or lesser) gain approved for the transmitter by Industry Canada. To reduce potential radio interference to other users, the antenna type

and its gain should be so chosen that the equivalent isotropically radiated power (e.i.r.p.) is not more than that necessary for successful communication.

En vertu des règlements d'Industrie Canada, cet émetteur radio ne peut fonctionner avec une antenne d'un type et un maximum (ou moins) approuvés pour gagner de l'émetteur par Industrie Canada. Pour réduire le risque d'interférence aux autres utilisateurs, le type d'antenne et son gain doivent être choisies de façon que la puissance isotrope rayonnée équivalente (PIRE) ne dépasse pas ce qui est nécessaire pour une communication réussie.

**Section 7.1.3 of RSS-GEN** This Device complies with Industry Canada License-exempt RSS standard(s). Operation is subject to the following two conditions: 1) this device may not cause interference, and 2) this device must accept any interference, including interference that may cause undesired operation of the device.

Cet appareil est conforme avec Industrie Canada RSS standard exemptes de licence(s). Son fonctionnement est soumis aux deux conditions suivantes: 1) ce dispositif ne peut causer des interférences, et 2) cet appareil doit accepter toute interférence, y compris les interférences qui peuvent causer un mauvais fonctionnement du dispositif.

This radio transmitter 6982A-YRHCPZWOFM has been approved by Industry Canada to operate with the antenna types listed below with the maximum permissible gain indicated. Antenna types not included in this list, having a gain greater than the maximum gain indicated for that type, are strictly prohibited for use with this device.

Le présent émetteur radio 6982A-YRHCPZWOFM a été approuvé par Industrie Canada pour fonctionner avec les types d'antenne énumérés ci-dessous et ayant un gain admissible maximal. Les types d'antenne non inclus dans cette liste, et dont le gain est supérieur au gain maximal indiqué, sont strictement interdits pour l'exploitation de l'émetteur.

CAN ICES-3B/NMB-3B

## **Yale Locks & Hardware**

Product Support Tel 1-855-213-5841 • [www.yalehome.com](http://www.yalehome.com)

Yale Locks & Hardware is a division of Yale Security Inc., an ASSA ABLOY Group company.

Yale® and Yale Real Living® are registered trademarks of Yale Security Inc., an ASSA ABLOY Group Company. Other products' brand names may be trademarks or registered trademarks of their respective owners and are mentioned for reference purposes only. Copyright © 2017, Yale Security Inc., an ASSA ABLOY Group company. All rights reserved. Reproduction in whole or in part without the express written permission of Yale Security Inc. is prohibited.

**YALE**, with its unique global reach and range of products, is the world's favorite lock  
– the preferred solution for securing your home, family and personal belongings.

**ASSA ABLOY** is the global leader in door opening solutions,  
dedicated to satisfying end-user needs for security, safety and convenience.

## Installing the ZigBee<sup>®</sup> Module

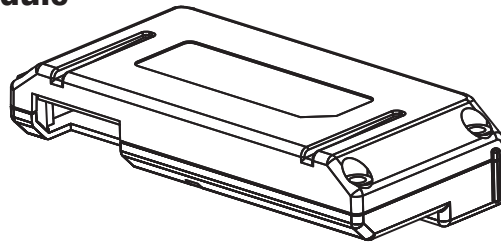

**IMPORTANT:** the batteries must be removed prior to removing and/or inserting the network module:



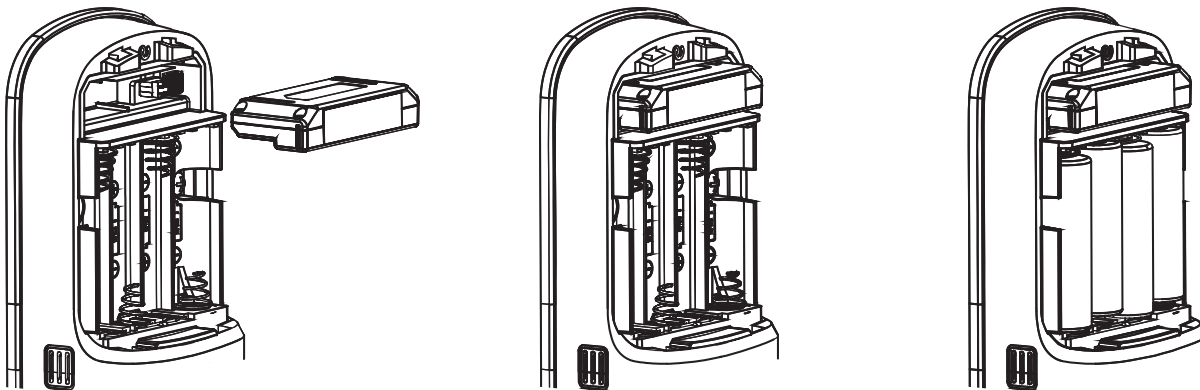

- Remove battery cover.
- Remove batteries.
- Remove and/or insert network module.
- Reinstall batteries.
- Replace cover.







## Enrolling/Unenrolling the Network Module:

This device is a security enabled ZigBee product that is able to use encrypted ZigBee messages to communicate to other security enabled ZigBee products. This device must be used in conjunction with a Security Enabled ZigBee Controller in order to fully utilize all implemented functions. This product can be operated in any ZigBee network with other ZigBee certified devices from other manufacturers. All non-battery operated nodes within the network will act as repeaters regardless of vendor to increase reliability of the network.

To Enroll the Module (Inclusion Mode):

- Enter the 4-8 digit Master PIN code followed by the  key.
- Press the  key followed by the  key.
- Press the  key followed by the  key.

To Unenroll the Module (Exclusion Mode):

- Enter the 4-8 digit Master PIN code followed by the  key.
- Press the  key followed by the  key.
- Press the  key followed by the  key.

**FCC:**

FCC ID: U4A-YRHCPZB0FM

Model: YRMZB2

This equipment has been tested and found to comply with the limits for a Class B digital device, pursuant to Part 15 of the FCC Rules. These limits are designed to provide reasonable protection against harmful interference in a residential installation. This equipment generates, uses, and can radiate radio frequency energy and, if not installed and used in accordance with the instructions, may cause harmful interference to radio communications. However, there is no guarantee that interference will not occur in a particular installation. If this equipment does cause harmful interference to radio or television reception, which can be determined by turning the equipment off and on, the user is encouraged to try to correct the interference by one or more of the following measures:

- Reorient or relocate the receiving antenna.
- Increase the separation between the equipment and receiver.
- Connect the equipment into an outlet on a circuit different from that to which the receiver is connected.
- Consult the dealer or an experienced radio/TV technician for help.

This equipment complies with FCC radiation exposure limits set forth for an uncontrolled environment. This equipment should be installed and operated with minimum distance 20cm between the radiator and your body. This transmitter must not be co-located or operating in conjunction with any other antenna or transmitter.

This device complies with Part 15 of the FCC rules. Operation is subject to the following two conditions: (1) This device may not cause harmful interference, and (2) this device must accept any interference received, including interference that may cause undesired operation. Any changes or modifications not expressly approved by manufacturer could void the user's authority to operate the equipment.

**IMPORTANT!** Any changes or modifications not expressly approved by the party responsible for compliance could void the user's authority to operate this equipment.

Industry Canada:

IC: 6982A-YRHCPZB0FM

Model: YRMZB2

This Device complies with Industry Canada License-exempt RSS standard(s). Operation is subject to the following two conditions: 1) this device may not cause interference, and 2) this device must accept any interference, including interference that may cause undesired operation of the device.

Le présent appareil est conforme aux CNR d'Industrie Canada applicables aux appareils radio exempts de licence. L'exploitation est autorisée aux deux conditions suivantes: (1) l'appareil ne doit pas produire de brouillage, et (2) l'utilisateur de l'appareil doit accepter tout brouillage radioélectrique subi, même si le brouillage est susceptible d'en compromettre le fonctionnement.

**Important Note:****Radiation Exposure Statement:**

This equipment complies with IC radiation exposure limits set forth for an uncontrolled environment. This equipment should be installed and operated with minimum distance 20cm between the radiator and your body.

**Note Importante: (Pour l'utilisation de dispositifs mobiles)****Declaration d'exposition aux radiations:**

Cet équipement est conforme aux limites d'exposition aux rayonnements IC établies pour un environnement non contrôlé. Cet équipement doit être installé et utilisé avec un minimum de 20 cm de distance entre la source de rayonnement et votre corps.

**IMPORTANT!** Any changes or modifications not expressly approved by the party responsible for compliance could void the user's authority to operate this equipment.

**IMPORTANT!** Tous les changements ou modifications pas expressément approuvés par la partie responsable de la conformité ont pu vider l'autorité de l'utilisateur pour actionner cet équipement.

CAN ICES-3B/NMB-3B

## Yale Locks & Hardware

Product Support Tel 1-855-213-5841 • [www.yalehome.com](http://www.yalehome.com)

Yale Locks &amp; Hardware is a division of Yale Security Inc., an ASSA ABLOY Group company.

Yale® and Yale Real Living® are registered trademarks of Yale Security Inc., an ASSA ABLOY Group Company.

Other products' brand names may be trademarks or registered trademarks of their respective owners and are mentioned for reference purposes only.

Copyright © 2017, Yale Security Inc., an ASSA ABLOY Group company.

All rights reserved. Reproduction in whole or in part without the express written permission of Yale Security Inc. is prohibited.

**YALE**, with its unique global reach and range of products, is the world's favorite lock  
– the preferred solution for securing your home, family and personal belongings.

**ASSA ABLOY** is the global leader in door opening solutions,  
dedicated to satisfying end-user needs for security, safety and convenience.

## Installing the Yale iM1 Network Module

**IMPORTANT:** the batteries must be removed prior to removing and/or inserting the network module:



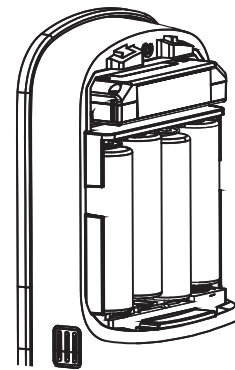
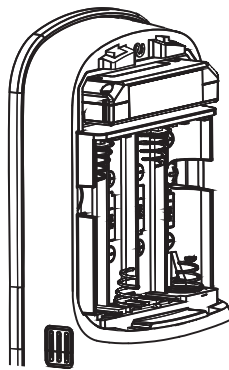
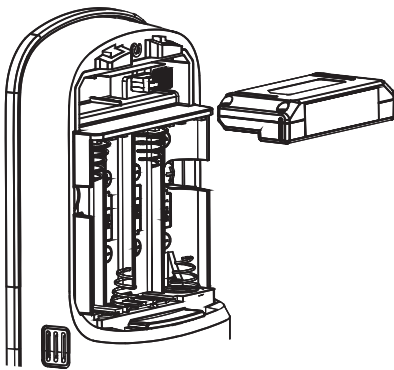
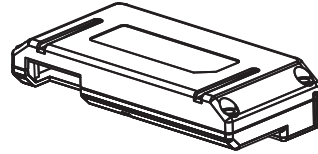

- Remove battery cover and batteries.
- Remove and/or insert Network Module.
- Reinstall batteries and battery cover.



## Enrolling the iM1 Network Module:

The Yale iM1 Network Module must be used with a Yale Assure Lock or Yale nexTouch Lock and cannot be used in conjunction with any other Yale Network Module.

To Enroll the Module:

- Enter the 4-8 digit Master PIN code followed by the  key.
- Press the  key followed by the  key.
- Press the  key followed by the  key.



## Yale® Secure App Connection with Yale® iM1 Network Module

### Connecting the Yale Secure App with the Yale iM1 Network Module

1. After following the steps listed on other side of page for enrolling the module, download the Yale Secure app from the App Store®.
2. Ensure Bluetooth® is enabled on your iPhone®, iPad® or iPod touch®, and that you're within a foot of your Yale lock.
3. Open the Yale Secure app and agree to allow the app to access your Home Data.
4. If you do not have a home already created, create a new home when prompted. Tap + to add a new Yale Lock.
5. The app will search for your Yale Lock. Be sure that you are within close proximity (less than two feet or so). When "Yale Lock" appears, tap to add.  
\*If the lock does not appear, enter your Master Pin Code on the lock keypad, tap the gear, tap 7, tap gear, tap 1 and then tap gear.
6. Scan your Accessory Setup Code; shown below, or manually enter within the app.

### Accessory Setup Code

### Yale Locks & Hardware

Product Support Tel 1-855-213-5841 • [www.yalehome.com](http://www.yalehome.com)

Yale Locks & Hardware is a division of Yale Security Inc., an ASSA ABLOY Group company.

Yale®, Yale Real Living® and Assure Lock® are registered trademarks of Yale Security Inc., an ASSA ABLOY Group Company. nexTouch™ is a trademark of Yale Security Inc., an ASSA ABLOY Group Company. Other products' brand names may be trademarks or registered trademarks of their respective owners and are mentioned for reference purposes only. Copyright © 2017, Yale Security Inc., an ASSA ABLOY Group Company. All rights reserved. Reproduction in whole or in part without the express written permission of Yale Security Inc. is prohibited. Apple®, iPhone®, iPad®, iPod touch® and Siri® are trademarks of Apple Inc., registered in the U.S. and other countries. HomeKit is a trademark of Apple Inc. Use of the Works with Apple HomeKit logo means that an electronic accessory has been designed to connect specifically to iPod touch, iPhone or iPad, respectively, and has been certified by the developer to meet Apple performance standards. Apple is not responsible for the operation of this device or its compliance with safety and regulatory standards. Use of the HomeKit logo means that an electronic accessory has been designed to connect specifically to iPod, iPhone, or iPad, respectively, and has been certified by the developer to meet Apple performance standards. Apple is not responsible for the operation of this device or its compliance with safety and regulatory standards. Please note that the use of this accessory with iPod, iPhone, or iPad may affect wireless performance.

**YALE**, with its unique global reach and range of products, is the world's favorite lock  
– the preferred solution for securing your home, family and personal belongings.

**ASSA ABLOY** is the global leader in door opening solutions,  
dedicated to satisfying end-user needs for security, safety and convenience.